

### AD7506/AD7507

#### FEATURES

- R<sub>ON</sub>: 300Ω**
- Power Dissipation: 1.5mW**
- TTL/DTL/CMOS Direct Interface**
- Break-Before-Make Switching**
- Standard 28-Pin DIPs and 28-Terminal Surface Mount Packages**

#### GENERAL DESCRIPTION

The AD7506 is a monolithic CMOS 16-channel analog multiplexer packaged in a 28-pin DIP or a 28-terminal surface mount package. It switches a common output to one of 16 inputs, depending on the state of four address lines and an "enable." The AD7507 is identical to the AD7506 except it has two outputs switched to two of 16 inputs depending on three binary address states and an "enable."

#### ABSOLUTE MAXIMUM RATINGS\*

- (T<sub>A</sub> = +25°C unless otherwise noted)
- V<sub>DD</sub> - GND . . . . . +17V
  - V<sub>SS</sub> - GND . . . . . -17V
  - V Between Any Switch Terminals (see Note 1) . . . . . 25V
  - Digital Input Voltage Range . . . . . V<sub>DD</sub> to GND
  - Overvoltage at V<sub>OUT</sub> (V<sub>S</sub>) . . . . . V<sub>SS</sub>, V<sub>DD</sub>
  - Overcurrent (I<sub>S</sub>, Continuous One Channel) . . . . . 20mA
  - Switch Current (I<sub>S</sub>, Surge One Channel) . . . . . 35mA
  - 1ms Duration, 10% Duty Cycle . . . . . 35mA
  - Power Dissipation (Any Package)
  - Up to +50°C . . . . . 1000mW
  - Derates above +50°C by . . . . . 10mW/°C
  - Operating Temperature
  - Commercial (KN Versions) . . . . . 0 to +70°C
  - Industrial (KQ Versions) . . . . . -25°C to +85°C
  - Extended (TQ, TE Versions) . . . . . -55°C to +125°C
  - Storage Temperature . . . . . -65°C to +150°C
  - Lead Temperature (Soldering, 10sec) . . . . . +300°C

#### CAUTION:

- <sup>1</sup>Do not apply voltage higher than V<sub>DD</sub> and V<sub>SS</sub> to any other terminal, especially when V<sub>SS</sub> = V<sub>DD</sub> = 0V all other pins should be at 0V.
- <sup>2</sup>The digital control inputs are diode protected; however, permanent damage may occur on unconnected units under high energy electrostatic fields. Keep unused units in conductive foam at all times.
- \*Stresses above those listed under "Absolute Maximum Ratings" may cause permanent damage to the device. This is a stress rating only and functional operation of the device at these or any other conditions above those indicated in the operational sections of this specification is not implied. Exposure to absolute maximum rating conditions for extended periods may affect device reliability. Only one Absolute Maximum Rating may be applied at any one time.

#### REV. A

Information furnished by Analog Devices is believed to be accurate and reliable. However, no responsibility is assumed by Analog Devices for its use, nor for any infringements of patents or other rights of third parties which may result from its use. No license is granted by implication or otherwise under any patent or patent rights of Analog Devices.

#### FUNCTIONAL DIAGRAMS

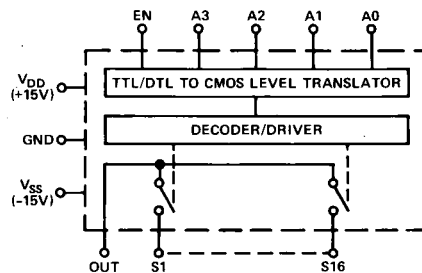

AD7506

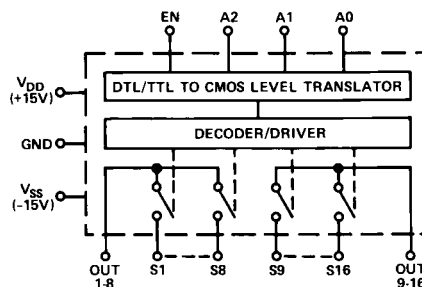

AD7507

#### ORDERING GUIDE

Model <sup>1</sup>	Temperature Range	Package Option <sup>2</sup>
AD7506KN	0°C to +70°C	N-28
AD7506KQ	-25°C to +85°C	Q-28
AD7506TQ	-55°C to +125°C	Q-28
AD7506TE	-55°C to +125°C	E-28A
AD7507KN	0°C to +70°C	N-28
AD7507KQ	-25°C to +85°C	Q-28
AD7507TQ	-55°C to +125°C	Q-28
AD7507TE	-55°C to +125°C	E-28A

#### NOTES

- <sup>1</sup>To order MIL-STD-883, Class B, processed parts, add/883B to part number. See Analog Devices Military Products Databook (1990) for military data sheet.
- <sup>2</sup>N = Plastic DIP; Q = Cerdip; E = Leadless Ceramic Chip Carrier (LCCC).

**One Technology Way, P.O. Box 9106, Norwood, MA 02062-9106, U.S.A.**  
**Tel: 617/329-4700 Fax: 617/326-8703 Twx: 710/394-6577**  
**Telex: 924491 Cable: ANALOG NORWOODMASS**

# AD7506/AD7507 — SPECIFICATIONS ( $V_{DD} = +15V$ , $V_{SS} = -15V$ unless otherwise noted.)

Parameter	Version <sup>1</sup>	Switch Condition	@ +25°C	Over Specified Temperature Range	Test Conditions	
<b>ANALOG SWITCH</b>						
$R_{ON}$	K T	ON ON	300Ω typ, 450Ω max 400Ω max	550Ω max 500Ω max	$V_S = -10V$ to +10V, $I_S = 1mA$	
$R_{ON}$ vs. $V_S$	All	ON	15% typ		$V_S = 0V$ , $I_S = 1mA$	
$R_{ON}$ vs. Temperature	All	ON	0.5%/°C typ			
$\Delta R_{ON}$ Between Switches	All	ON	4% typ			
$R_{ON}$ vs. Temperature Between Switches	All	ON	0.05%/°C typ			
$I_S$ (OFF)	K T	OFF OFF	0.05nA typ, 5nA max 0.05nA typ, 1nA max	50nA max 50nA max	$V_S = -10V$ , $V_{OUT} = +10V$ and	
$I_{OUT}$ (OFF)	AD7506	K T	OFF OFF	0.3nA typ, 20nA max 0.3nA typ, 10nA max	500nA max 500nA max	$V_S = +10V$ , $V_{OUT} = -10V$ “Enable” Low
		K T	OFF OFF	0.3nA typ, 10nA max 0.3nA typ, 5nA max	250nA max 250nA max	
$I_{OUT} - I_S$ (Any Switch ON)	AD7506	K T	ON ON	0.3nA typ, 20nA max 0.3nA typ, 10nA max	500nA max 500nA max	$V_S = 0V$
		K T	ON ON	0.3nA typ, 10nA max 0.3nA typ, 5nA max	250nA max 250nA max	
AD7507	AD7507	K T	ON ON	0.3nA typ, 10nA max 0.3nA typ, 5nA max	250nA max 250nA max	
		K T	ON ON	0.3nA typ, 10nA max 0.3nA typ, 5nA max	250nA max 250nA max	
<b>DIGITAL CONTROL</b>						
$V_{INL}$	All			0.8V max		
$V_{INH}$	All			2.4V min		
$I_{INL}$ or $I_{INH}$	All		10μA max	30μA max		
$C_{IN}$	All		3pF typ			
<b>DYNAMIC CHARACTERISTICS<sup>2</sup></b>						
$t_{TRANSITION}$	All		700ns typ, 1000ns max		$V_{IN}$ : 0 to 3.0V	
$t_{OPEN}$	All		100ns typ			
$t_{ON}$ (En)	All		1.5μs max		$V_{EN}$ : 0 to 3.0V	
$t_{OFF}$ (En)	All		1μs max			
“OFF” Isolation	All		70dB typ		$V_{EN} = 0$ , $R_L = 200\Omega$ , $C_L = 3.0pF$ , $V_S = 3.0V$ rms, $f = 50kHz$	
$C_S$	All	OFF	5pF typ			
$C_{OUT}$	AD7506	All	OFF	40pF typ		
	AD7507	All	OFF	20pF typ		
$C_{S-OUT}$	All	OFF	0.5pF typ			
$C_{SS}$ Between Any Two Switches	All	OFF	0.5pF typ			
<b>POWER SUPPLY</b>						
$I_{DD}$	K T	OFF OFF	0.05mA typ, 1mA max 0.05mA typ, 1mA max	2mA max	All Digital Inputs Low	
		K T	OFF OFF	0.05mA typ, 1mA max 0.05mA typ, 1mA max		2mA max
$I_{DD}$	K T	ON ON	0.3mA typ, 1mA max 0.3mA typ, 1mA max	2mA max	All Digital Inputs High	
		K T	ON ON	0.05mA typ, 1mA max 0.05mA typ, 1mA max		2mA max

## NOTES

<sup>1</sup>KN Version specified for 0 to +70°C; KQ Version for -25°C to +85°C; and TQ, TE Versions for -55°C to +125°C.

<sup>2</sup>Sample tested to ensure compliance.

Specifications subject to change without notice.

## CAUTION

ESD (electrostatic discharge) sensitive device. The digital control inputs are diode protected; however, permanent damage may occur on unconnected devices subject to high energy electrostatic fields. Unused devices must be stored in conductive foam or shunts. The protective foam should be discharged to the destination socket before devices are removed.



## TRUTH TABLES

AD7506					
A <sub>3</sub>	A <sub>2</sub>	A <sub>1</sub>	A <sub>0</sub>	E <sub>N</sub>	"ON"
0	0	0	0	1	1
0	0	0	1	1	2
0	0	1	0	1	3
0	0	1	1	1	4
0	1	0	0	1	5
0	1	0	1	1	6
0	1	1	0	1	7
0	1	1	1	1	8
1	0	0	0	1	9
1	0	0	1	1	10
1	0	1	0	1	11
1	0	1	1	1	12
1	1	0	0	1	13
1	1	0	1	1	14
1	1	1	0	1	15
1	1	1	1	1	16
X	X	X	X	0	None

AD7507				
A <sub>2</sub>	A <sub>1</sub>	A <sub>0</sub>	E <sub>N</sub>	"ON"
0	0	0	1	1 & 9
0	0	1	1	2 & 10
0	1	0	1	3 & 11
0	1	1	1	4 & 12
1	0	0	1	5 & 13
1	0	1	1	6 & 14
1	1	0	1	7 & 15
1	1	1	1	8 & 16
X	X	X	0	None

## PIN CONFIGURATIONS

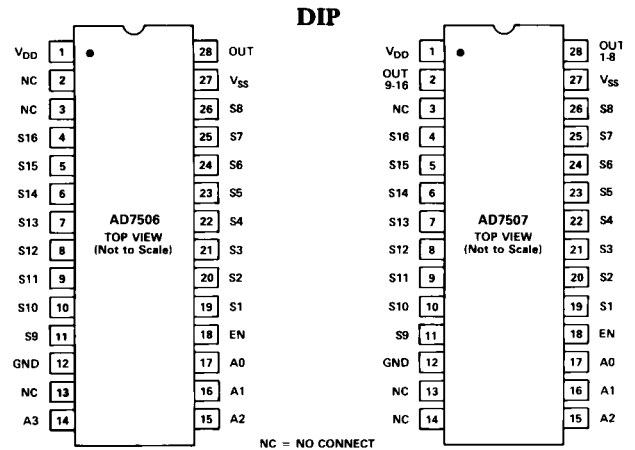

## Typical Performance Characteristics

### 1. R<sub>ON</sub> vs. V<sub>S</sub>

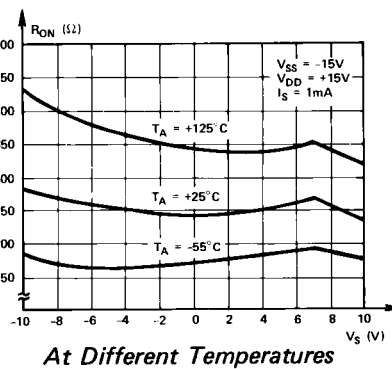
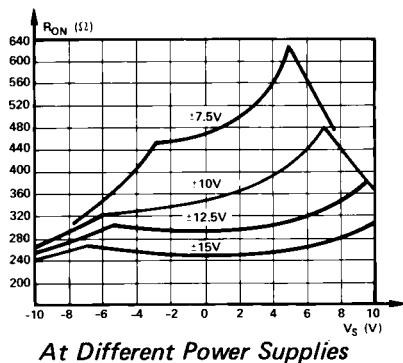

### 2. I<sub>OUT</sub> vs. V<sub>OUT</sub>

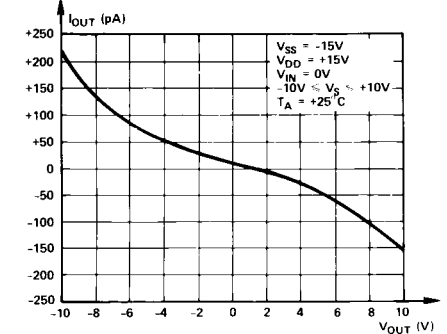

### 3. I<sub>OUT</sub> vs. T<sub>A</sub>

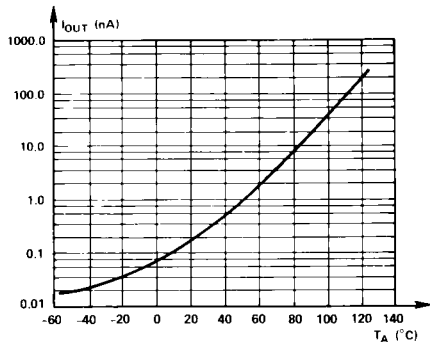

### 4. t<sub>TRANSITION</sub> vs. V<sub>IN</sub>

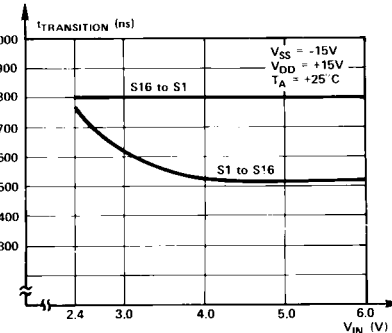

### 5. P<sub>D</sub> vs. Logic Frequency

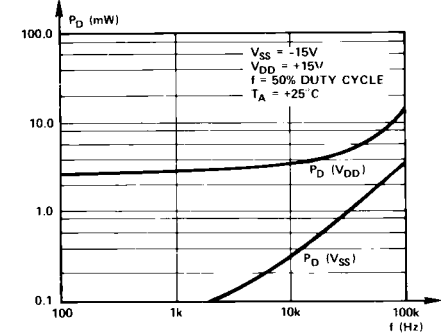

# AD7506/AD7507

## TYPICAL SWITCHING CHARACTERISTICS

### TEST CIRCUIT 1

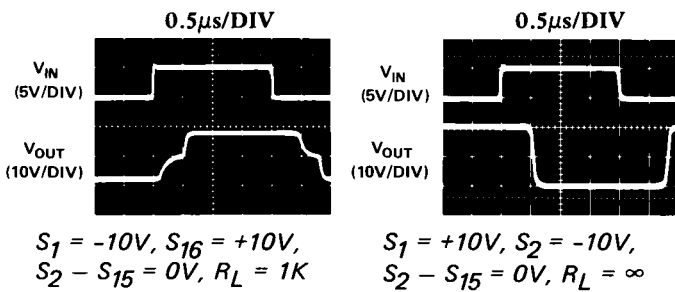
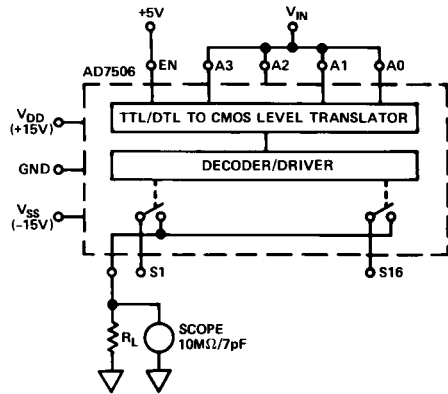

### TEST CIRCUIT 2

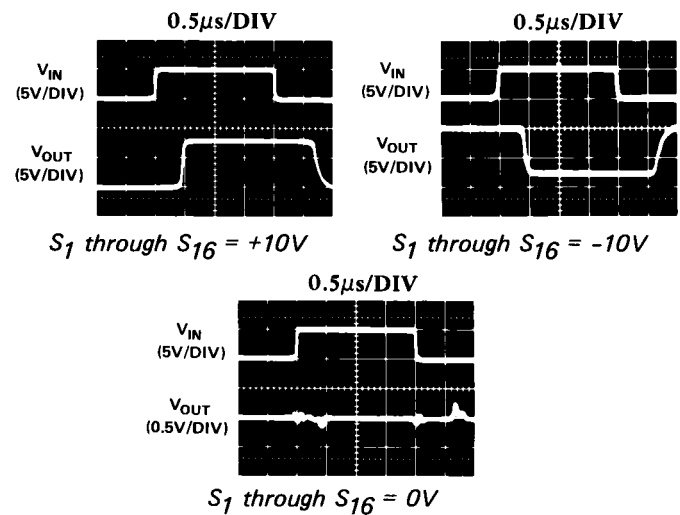
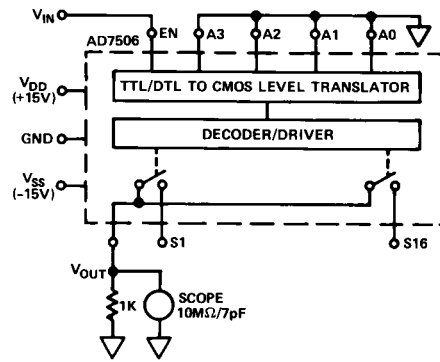

### OUTLINE DIMENSIONS

Dimensions shown in inches and (mm).

#### 28-Pin Plastic DIP (Suffix N)

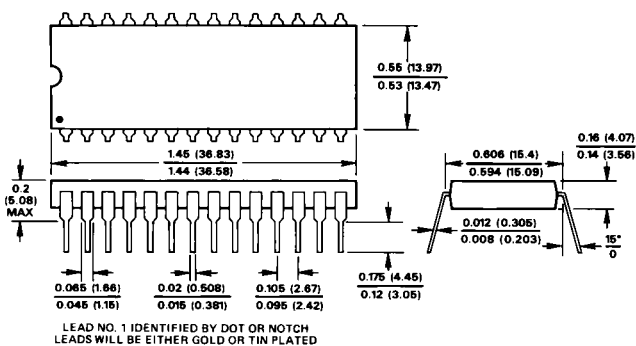

#### 28-Pin Cerdip (Q-28)

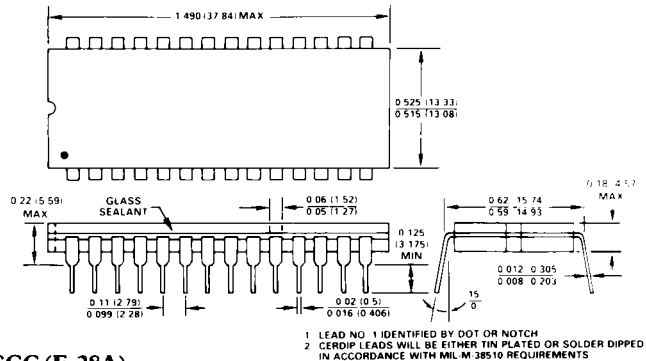

#### 28-Terminal LCCC (E-28A)

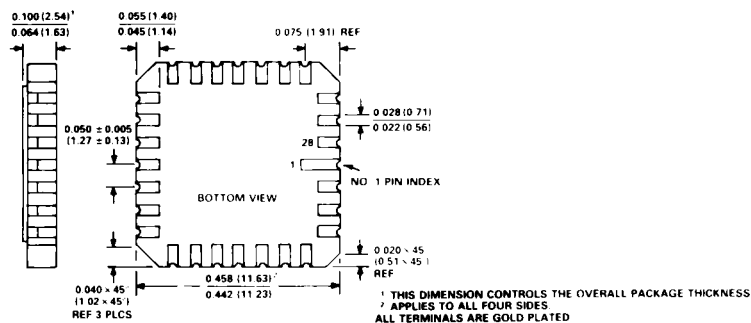

## Данный компонент на территории Российской Федерации

### Вы можете приобрести в компании MosChip.

Для оперативного оформления запроса Вам необходимо перейти по данной ссылке:

<http://moschip.ru/get-element>

Вы можете разместить у нас заказ для любого Вашего проекта, будь то серийное производство или разработка единичного прибора.

В нашем ассортименте представлены ведущие мировые производители активных и пассивных электронных компонентов.

Нашей специализацией является поставка электронной компонентной базы двойного назначения, продукции таких производителей как XILINX, Intel (ex.ALTERA), Vicor, Microchip, Texas Instruments, Analog Devices, Mini-Circuits, Amphenol, Glenair.

Сотрудничество с глобальными дистрибьюторами электронных компонентов, предоставляет возможность заказывать и получать с международных складов практически любой перечень компонентов в оптимальные для Вас сроки.

На всех этапах разработки и производства наши партнеры могут получить квалифицированную поддержку опытных инженеров.

Система менеджмента качества компании отвечает требованиям в соответствии с ГОСТ Р ИСО 9001, ГОСТ РВ 0015-002 и ЭС РД 009

### Офис по работе с юридическими лицами:

105318, г.Москва, ул.Щербаковская д.3, офис 1107, 1118, ДЦ «Щербаковский»

Телефон: +7 495 668-12-70 (многоканальный)

Факс: +7 495 668-12-70 (доб.304)

E-mail: [info@moschip.ru](mailto:info@moschip.ru)

Skype отдела продаж:

moschip.ru

moschip.ru\_4

moschip.ru\_6

moschip.ru\_9