

PART NUMBER	SSP-DM0	REV.	A
DATE	E.C.N. NUMBER AND REVISION COMMENTS		REV.
02.28.12	E.C.N. #11809.		A

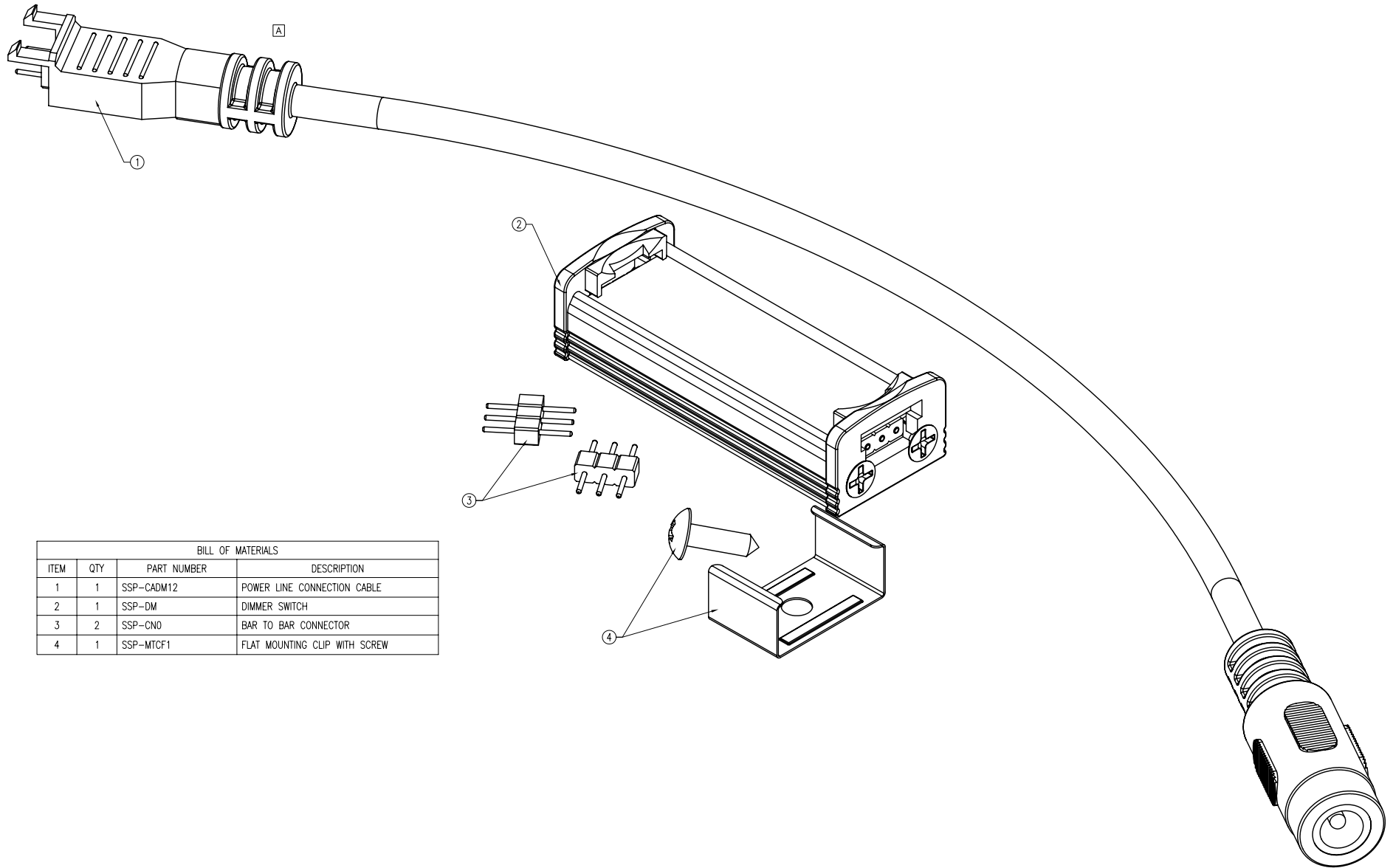

BILL OF MATERIALS			
ITEM	QTY	PART NUMBER	DESCRIPTION
1	1	SSP-CADM12	POWER LINE CONNECTION CABLE
2	1	SSP-DM	DIMMER SWITCH
3	2	SSP-CN0	BAR TO BAR CONNECTOR
4	1	SSP-MTCF1	FLAT MOUNTING CLIP WITH SCREW

\*UNLESS OTHERWISE SPECIFIED TOLERANCES PER DECIMAL PRECISION ARE: X=±1 (±0.039), X.X=±0.5 (±0.020), X.XX=±0.25 (±0.010), X.XXX=±0.127 (±0.005). LEAD SIZE=±0.05 (±0.002), LEAD LENGTH=±0.75 (±0.030). MIN.= <sup>+0.00</sup>DECIMAL PRECISION MAX.= <sup>+0.00</sup>DECIMAL PRECISION <sub>-0.00</sub>DECIMAL PRECISION



290 E. HELEN ROAD  
 PALATINE, IL 60067-6976  
 PHONE: +1.847.359.2790  
 FAX: +1.847.359.6538  
 WEB: WWW.LUMEX.COM

SUNBRITE DIMMER SWITCH KIT FOR MODULAR LED LIGHTBAR.

\*\*THE SPECIFICATIONS MAY CHANGE AT ANY TIME WITHOUT NOTICE DUE TO NEW MATERIALS OR PRODUCT IMPROVEMENT.\*\*

CONFIDENTIAL INFORMATION  
 THE INFORMATION CONTAINED IN THIS DOCUMENT IS THE PROPERTY OF LUMEX INC. EXCEPT AS SPECIFICALLY AUTHORIZED IN WRITING BY LUMEX INC., THE HOLDER OF THIS DOCUMENT SHALL KEEP ALL INFORMATION CONTAINED HEREIN CONFIDENTIAL AND SHALL PROTECT SAME IN WHOLE OR IN PART FROM DISCLOSURE AND DISSEMINATION TO ALL THIRD PARTIES.

DATE:	07.13.11	DRAWN BY:	AB
PAGE:	1 OF 3	CHKD BY:	KF
SCALE:	NTS	APRVD BY:	KF
UNIT:	mm [INCH]		Ⓟ

PART NUMBER	SSP-DMO	REV.	A
DATE	E.C.N. NUMBER AND REVISION COMMENTS		REV.
02.28.12	E.C.N. #11809.		A

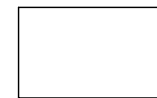
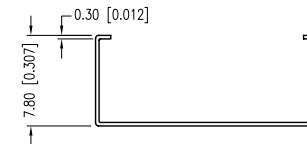
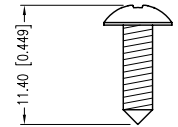
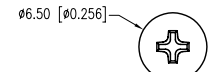
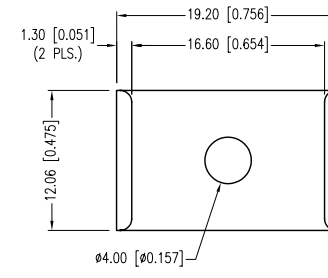
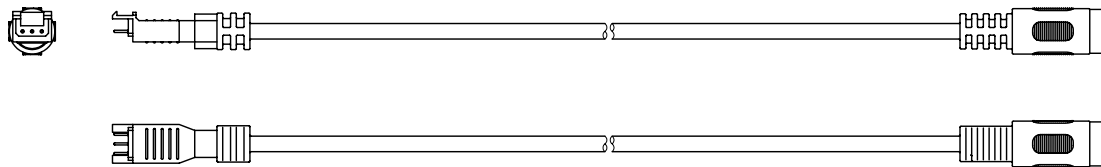
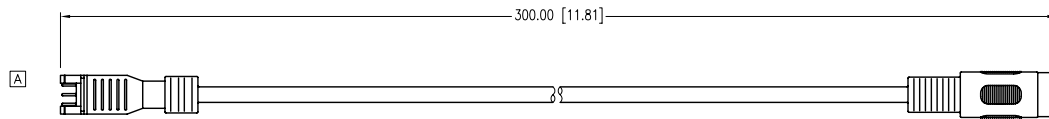
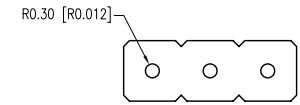
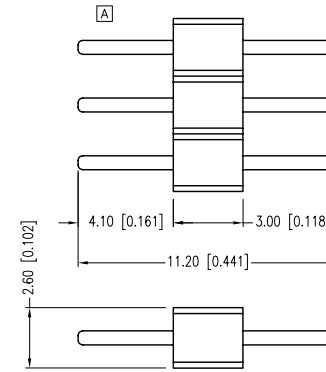
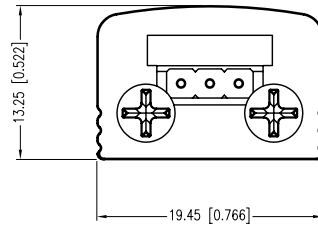
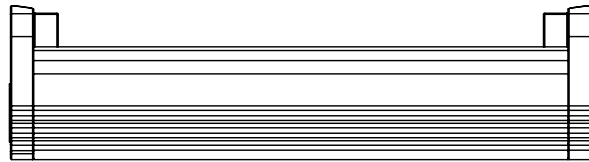

\*UNLESS OTHERWISE SPECIFIED TOLERANCES PER DECIMAL PRECISION ARE: X=±1 (±0.039), X.X=±0.5 (±0.020), X.XX=±0.25 (±0.010), X.XXX=±0.127 (±0.005). LEAD SIZE=±0.05 (±0.002), LEAD LENGTH=±0.75 (±0.030). MIN.= +<sup>DECIMAL PRECISION</sup> -<sub>DECIMAL PRECISION</sub>



290 E. HELEN ROAD  
PALATINE, IL 60067-6976  
PHONE: +1.847.359.2790  
FAX: +1.847.359.6538  
WEB: WWW.LUMEX.COM

SUNBRITE DIMMER SWITCH KIT FOR MODULAR LED LIGHTBAR.

\*\*THE SPECIFICATIONS MAY CHANGE AT ANY TIME WITHOUT NOTICE DUE TO NEW MATERIALS OR PRODUCT IMPROVEMENT.\*\*

CONFIDENTIAL INFORMATION  
THE INFORMATION CONTAINED IN THIS DOCUMENT IS THE PROPERTY OF LUMEX INC. EXCEPT AS SPECIFICALLY AUTHORIZED IN WRITING BY LUMEX INC., THE HOLDER OF THIS DOCUMENT SHALL KEEP ALL INFORMATION CONTAINED HEREIN CONFIDENTIAL AND SHALL PROTECT SAME IN WHOLE OR IN PART FROM DISCLOSURE AND DISSEMINATION TO ALL THIRD PARTIES.

DATE:	07.13.11	DRAWN BY:	AB
PAGE:	2 OF 3	CHKD BY:	KF
SCALE:	NTS	APRVD BY:	KF
UNIT:	mm [INCH]		Ⓟ

PART NUMBER	SSP-DM0	REV.	A
DATE	E.C.N. NUMBER AND REVISION COMMENTS		REV.
02.28.12	E.C.N. #11809.		A

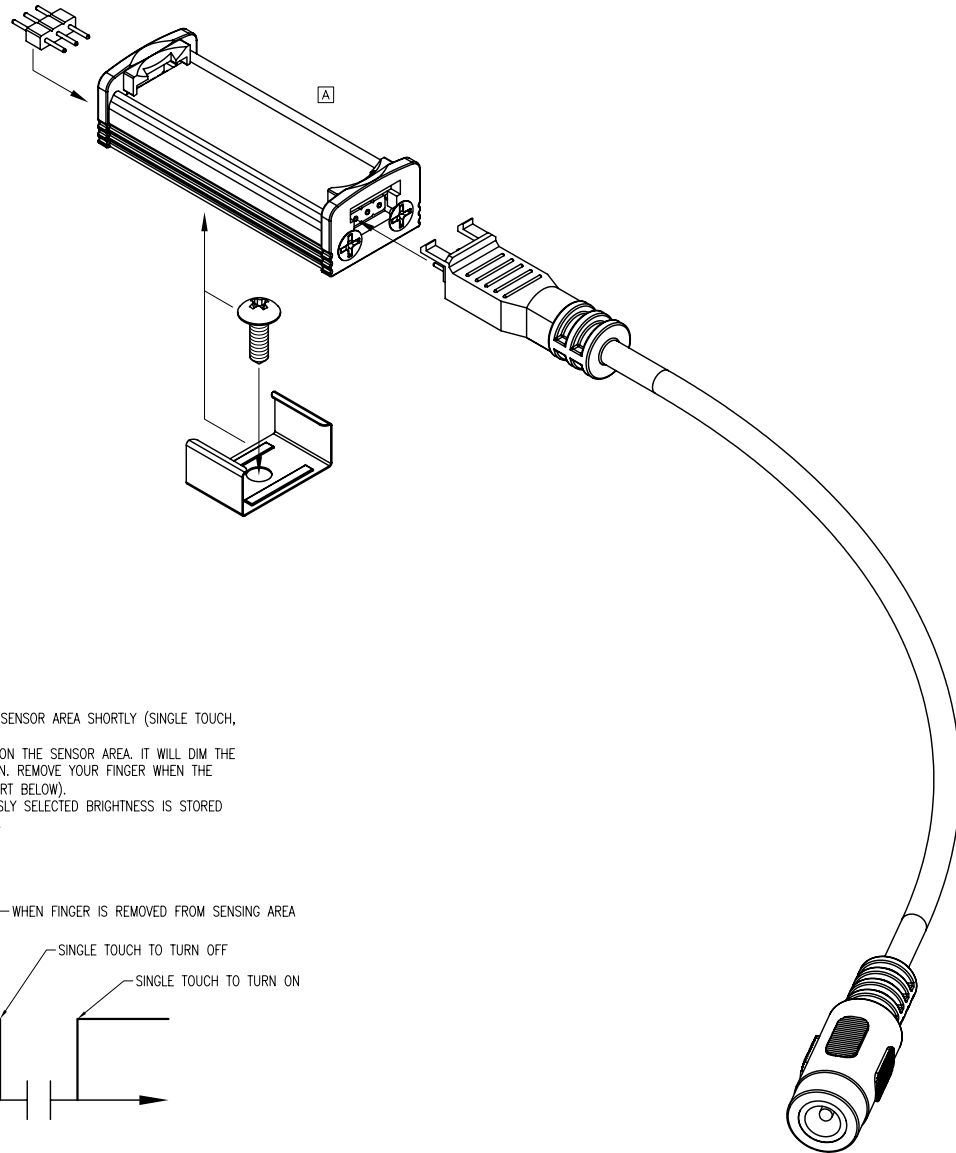

OPERATION DESCRIPTION

1. ON/OFF: USE YOUR FINGER TO TOUCH THE SENSOR AREA SHORTLY (SINGLE TOUCH, ~0.5 SECONDS, SEE CHART BELOW).
2. DIMMING: CONTINUE TO HOLD YOUR FINGER ON THE SENSOR AREA. IT WILL DIM THE LIGHTBAR BRIGHTNESS IN A CYCLING PATTERN. REMOVE YOUR FINGER WHEN THE DESIRED BRIGHTNESS IS ACHIEVED (SEE CHART BELOW).
3. BRIGHTNESS SETTING MEMORY: THE PREVIOUSLY SELECTED BRIGHTNESS IS STORED UNTIL THE ADAPTOR PLUG IS DISCONNECTED.

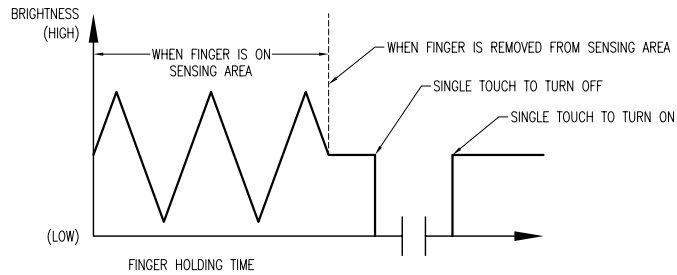

\*UNLESS OTHERWISE SPECIFIED TOLERANCES PER DECIMAL PRECISION ARE: X=±1 (±0.039), X.X=±0.5 (±0.020), X.XX=±0.25 (±0.010), X.XXX=±0.127 (±0.005). LEAD SIZE=±0.05 (±0.002), LEAD LENGTH=±0.75 (±0.030). MIN.= <sup>+0.00</sup> DECIMAL PRECISION MAX.= <sup>+0.00</sup> DECIMAL PRECISION -0.00



290 E. HELEN ROAD  
 PALATINE, IL 60067-6976  
 PHONE: +1.847.359.2790  
 FAX: +1.847.359.6538  
 WEB: WWW.LUMEX.COM

SUNBRITE DIMMER SWITCH KIT FOR MODULAR LED LIGHTBAR.

\*\*THE SPECIFICATIONS MAY CHANGE AT ANY TIME WITHOUT NOTICE DUE TO NEW MATERIALS OR PRODUCT IMPROVEMENT.\*\*

CONFIDENTIAL INFORMATION  
 THE INFORMATION CONTAINED IN THIS DOCUMENT IS THE PROPERTY OF LUMEX INC. EXCEPT AS SPECIFICALLY AUTHORIZED IN WRITING BY LUMEX INC., THE HOLDER OF THIS DOCUMENT SHALL KEEP ALL INFORMATION CONTAINED HEREIN CONFIDENTIAL AND SHALL PROTECT SAME IN WHOLE OR IN PART FROM DISCLOSURE AND DISSEMINATION TO ALL THIRD PARTIES.

DATE:	07.13.11	DRAWN BY:	AB
PAGE:	3 OF 3	CHKD BY:	KF
SCALE:	NTS	APRVD BY:	KF
UNIT:	mm [INCH]		Ⓟ

## Данный компонент на территории Российской Федерации

### Вы можете приобрести в компании MosChip.

Для оперативного оформления запроса Вам необходимо перейти по данной ссылке:

<http://moschip.ru/get-element>

Вы можете разместить у нас заказ для любого Вашего проекта, будь то серийное производство или разработка единичного прибора.

В нашем ассортименте представлены ведущие мировые производители активных и пассивных электронных компонентов.

Нашей специализацией является поставка электронной компонентной базы двойного назначения, продукции таких производителей как XILINX, Intel (ex.ALTERA), Vicor, Microchip, Texas Instruments, Analog Devices, Mini-Circuits, Amphenol, Glenair.

Сотрудничество с глобальными дистрибьюторами электронных компонентов, предоставляет возможность заказывать и получать с международных складов практически любой перечень компонентов в оптимальные для Вас сроки.

На всех этапах разработки и производства наши партнеры могут получить квалифицированную поддержку опытных инженеров.

Система менеджмента качества компании отвечает требованиям в соответствии с ГОСТ Р ИСО 9001, ГОСТ РВ 0015-002 и ЭС РД 009

### Офис по работе с юридическими лицами:

105318, г.Москва, ул.Щербаковская д.3, офис 1107, 1118, ДЦ «Щербаковский»

Телефон: +7 495 668-12-70 (многоканальный)

Факс: +7 495 668-12-70 (доб.304)

E-mail: [info@moschip.ru](mailto:info@moschip.ru)

Skype отдела продаж:

moschip.ru

moschip.ru\_4

moschip.ru\_6

moschip.ru\_9