

# HLMP-ELxx, HLMP-EHxx, HLMP-EDxx

## Precision Optical Performance AlInGaP II LED Lamps



## Data Sheet



Lead (Pb) Free  
RoHS 6 fully  
compliant



### Description

Precision Optical Performance AlInGaP II (aluminum indium gallium phosphide) LEDs offer superior light output for excellent readability in sunlight and dependable performance. The AlInGaP II technology provides extremely stable light output over long periods of time.

These LED lamps are untinted, nondiffused, T-1<sup>3</sup>/<sub>4</sub> packages incorporating second generation optics which produce well defined radiation patterns at specific viewing cone angles.

These lamps are made with an advanced optical grade epoxy offering superior high temperature and high moisture resistance performance in outdoor signal and sign applications. The maximum LED junction temperature limit of +130°C enables high temperature operation in bright sunlight conditions. The epoxy contains both uv-a and uv-b inhibitors to reduce the effects of long term exposure to direct sunlight.

### Benefits

- Viewing angles match traffic management requirements
- Colors meet automotive and traffic signal specifications
- Superior light output performance in outdoor environments
- Suitable for autoinsertion into PC boards

### Features

- Well defined spatial radiation patterns
- Viewing angles: 15°, 23°, 30°
- High luminous output
- Colors:
  - 592 nm Amber
  - 617 nm Reddish-Orange
  - 630 nm Red
- High operating temperature:  
 $T_{JLED} = +130^{\circ}\text{C}$
- Superior resistance to moisture

### Applications

- Traffic management:
  - Traffic signals
  - Work zone warning lights
  - Variable message signs
- Commercial outdoor advertising:
  - Signs
  - Marquees
- Automotive:
  - Exterior and interior lights

## T-1<sup>3</sup>/<sub>4</sub> (5 mm) Precision Optical Performance AlInGaP II LED Lamps

### Selection Guide

Typical Viewing Angle $2\theta_{1/2}$ (Deg.) <sup>[2]</sup>	Color and Dominant Wavelength (nm), Typ. <sup>[1]</sup>	Lamps Without Standoffs (Outline Drawing A)	Lamps With Standoffs (Outline Drawing B)	Luminous Intensity $I_v$ (mcd) <sup>[3,4,5]</sup> @ $I(f) = 20 \text{ mA}$			
				Min.	Max.		
15°	Amber 592	HLMP-EL16-S0000	HLMP-EL18-S0000	1900	–		
		HLMP-EL16-TW000		2500	7200		
		HLMP-EL16-UX000	HLMP-EL18-UX000	3200	9300		
		HLMP-EL16-UXR00		3200	9300		
		HLMP-EL16-VW000		4200	7200		
		HLMP-EL16-VX400		7200	21000		
		HLMP-EL16-VY000	HLMP-EL18-VY000	4200	12000		
		HLMP-EL16-VYR00	HLMP-EL18-VYR00	4200	12000		
		HLMP-EL16-VYK00		4200	12000		
		HLMP-EL16-VYS00	HLMP-EL18-VYS00	4200	12000		
		Red-Orange 617	Red-Orange 617	HLMP-EH16-TW000		2500	7200
				HLMP-EH16-UX000	HLMP-EH18-UX000	3200	9300
HLMP-EH16-VX0DD				4200	9300		
Red 630	Red 630	HLMP-ED16-S0000	HLMP-ED18-S0000	1900	–		
		HLMP-ED16-TW000	HLMP-ED18-TW000	2500	7200		
			HLMP-ED18-TWT00	2500	7200		
		HLMP-ED16-UX000	HLMP-ED18-UX000	3200	9300		
		HLMP-ED16-UXT00	HLMP-ED18-UXT00	3200	9300		
		HLMP-ED16-VX000	HLMP-ED18-VX000	4200	9300		

#### Notes:

1. Dominant Wavelength,  $\lambda_d$ , is derived from the CIE Chromaticity Diagram and represents the color of the lamp.
2.  $\theta_{1/2}$  is the off-axis angle where the luminous intensity is one half the on-axis intensity.
3. The luminous intensity is measured on the mechanical axis of the lamp package.
4. The optical axis is closely aligned with the package mechanical axis.
5. Tolerance for each intensity bin limit is  $\pm 15\%$ .

## T-1<sup>3</sup>/<sub>4</sub> (5 mm) Precision Optical Performance AlInGaP II Led Lamps (Continued)

### Selection Guide

Typical Viewing Angle $2\theta_{1/2}$ (Deg.) <sup>[2]</sup>	Color and Dominant Wavelength (nm), Typ. <sup>[1]</sup>	Lamps Without Standoffs (Outline Drawing A)	Lamps With Standoffs (Outline Drawing B)	Luminous Intensity $I_v$ (mcd) <sup>[3,4,5]</sup> @ $I(f) = 20$ mA	
				Min.	Max.
23°	Amber 592	HLMP-EL25-Q0000	HLMP-EL27-Q0000	1150	–
			HLMP-EL27-QTR00	1150	3200
		HLMP-EL25-RU000	HLMP-EL27-RU000	1500	4200
		HLMP-EL25-SU000		1900	4200
		HLMP-EL25-SVK00		1900	5500
		HLMP-EL25-SV000	HLMP-EL27-SV000	1900	5500
		HLMP-EL25-SVR00	HLMP-EL27-SVR00	1900	5500
		HLMP-EL25-TW000	HLMP-EL27-TW000	2500	7200
		HLMP-EL25-TWR00	HLMP-EL27-TWR00	2500	7200
		HLMP-EL25-TWK00		2500	7200
		HLMP-EL25-TWS00		2500	7200
	HLMP-EL25-UX000		3200	9300	
	Red-Orange 617	HLMP-EH25-QT000	HLMP-EH27-QT000	1150	3200
		HLMP-EH25-SV000		1900	5500
		HLMP-EH25-TW000	HLMP-EH27-TW000	2500	7200
	Red 630	HLMP-ED25-RU000		3200	9300
		HLMP-ED25-RUT00		3200	9300
		HLMP-ED25-SV000	HLMP-ED27-SV000	1900	5500
		HLMP-ED25-TW000	HLMP-ED27-TW000	2500	7200
HLMP-ED25-TWT00		HLMP-ED27-TWT00	2500	7200	

#### Notes:

1. Dominant Wavelength,  $\lambda_d$ , is derived from the CIE Chromaticity Diagram and represents the color of the lamp.
2.  $\theta_{1/2}$  is the off-axis angle where the luminous intensity is one half the on-axis intensity.
3. The luminous intensity is measured on the mechanical axis of the lamp package.
4. The optical axis is closely aligned with the package mechanical axis.
5. Tolerance for each intensity bin limit is  $\pm 15\%$ .

## T-1<sup>3</sup>/<sub>4</sub> (5 mm) Precision Optical Performance AllnGaP II Led Lamps (Continued)

### Selection Guide

Typical Viewing Angle $2\theta_{1/2}$ (Deg.) <sup>[2]</sup>	Color and Dominant Wavelength (nm), Typ. <sup>[1]</sup>	Lamps Without Standoffs (Outline Drawing A)	Lamps With Standoffs (Outline Drawing B)	Luminous Intensity $I_v$ (mcd) <sup>[3,4,5]</sup> @ $I(f) = 20$ mA	
				Min.	Max.
30°	Amber 592	HLMP-EL31-P0000		880	–
		HLMP-EL31-QT000	HLMP-EL33-QT000	1150	3200
		HLMP-EL31-QTR00		1150	3200
		HLMP-EL31-SV000	HLMP-EL33-SV000	1900	5500
		HLMP-EL31-SVK00		1900	5500
		HLMP-EL31-SVR00	HLMP-EL33-SVR00	1900	5500
		HLMP-EL31-STR00		1900	3200
		HLMP-EL31-SUK00		1900	4200
		HLMP-EL31-SUS00		1900	4200
		HLMP-EL31-SUR00		1900	4200
		HLMP-EL31-SVK00		1900	5500
		HLMP-EL31-SVS00		1900	5500
		Red-Orange 617	HLMP-EH31-QT000		1150
			HLMP-EH33-RU000	1500	4200
	HLMP-EH31-SV000		HLMP-EH33-SV000	1900	5500
	Red 630	HLMP-ED31-Q0000	HLMP-ED33-Q0000	1150	–
		HLMP-ED31-QTT00		1150	3200
		HLMP-ED31-ST000		1900	3200
		HLMP-ED31-SUT00		1900	4200
		HLMP-ED31-RU000		1500	4200
HLMP-ED31-RUT00		HLMP-ED33-RUT00	1500	4200	
HLMP-ED31-SV000		HLMP-ED33-SV000	1900	5500	
HLMP-ED31-SVT00		HLMP-ED33-SVT00	1900	5500	

#### Notes:

1. Dominant Wavelength,  $\lambda_{d_r}$ , is derived from the CIE Chromaticity Diagram and represents the color of the lamp.
2.  $\theta_{1/2}$  is the off-axis angle where the luminous intensity is one half the on-axis intensity.
3. The luminous intensity is measured on the mechanical axis of the lamp package.
4. The optical axis is closely aligned with the package mechanical axis.
5. Tolerance for each intensity bin limit is  $\pm 15\%$ .

## Part Numbering System

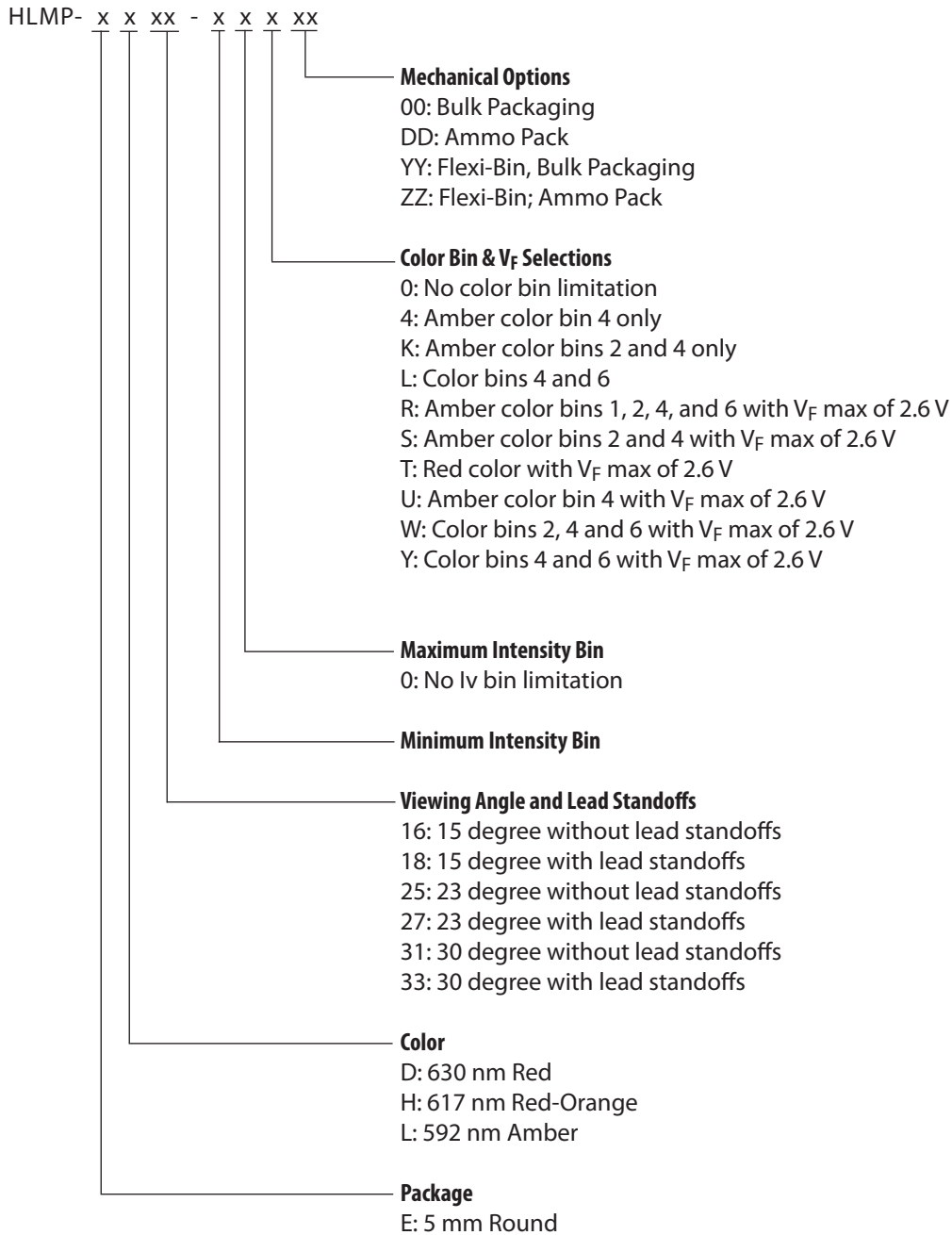

Note: Please refer to AB 5337 for complete information on part numbering system.

# Package Dimensions

**A**

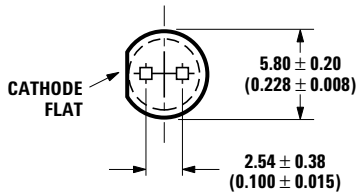
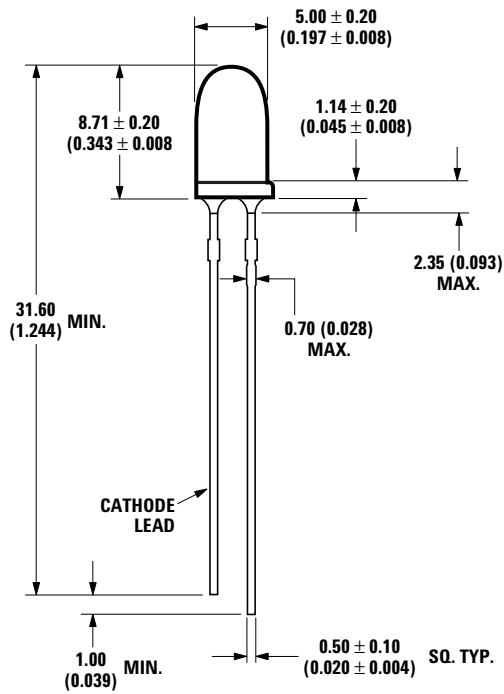

**B**

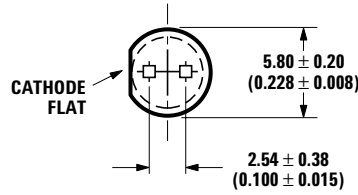
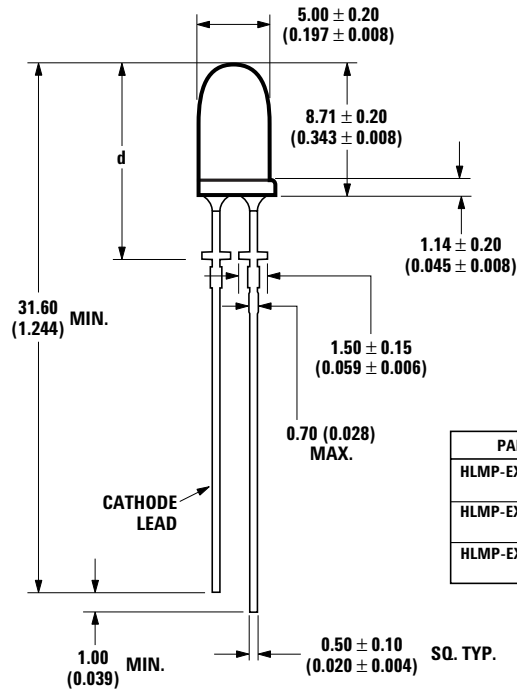

PART NO.	d
HLMP-EX18-xxxxx	12.60 ± 0.18 (0.496 ± 0.007)
HLMP-EX27-xxxxx	11.33 ± 0.25 (0.446 ± 0.010)
HLMP-EX33-xxxxx	11.99 ± 0.25 (0.472 ± 0.010)

## Absolute Maximum Ratings at $T_A = 25^\circ\text{C}$

DC Forward Current <sup>[1,2,3]</sup>	50 mA
Peak Pulsed Forward Current <sup>[2,3]</sup>	100 mA
Average Forward Current	30 mA
Reverse Voltage ( $I_R = 100 \mu\text{A}$ )	5 V
LED Junction Temperature	130°C
Operating Temperature	-40°C to +100°C
Storage Temperature	-40°C to +100°C

### Notes:

- Derate linearly as shown in Figure 4.
- For long term performance with minimal light output degradation, drive currents between 10 mA and 30 mA are recommended. For more information on recommended drive conditions, please refer to Application Brief I-024 (5966-3087E).
- Please contact your sales representative about operating currents below 10 mA.

### Electrical/Optical Characteristics at $T_A = 25^\circ\text{C}$

Parameter	Symbol	Min.	Typ.	Max.	Units	Test Conditions
Forward Voltage						$I_F = 20\text{ mA}$
Amber ( $\lambda_d = 592\text{ nm}$ )			2.3			
Red-Orange ( $\lambda_d = 617\text{ nm}$ )	$V_F$		2.35	2.6 <sup>[1]</sup>	V	
Red ( $\lambda_d = 630\text{ nm}$ )			2.4			
Reverse Voltage	$V_R$	5	20		V	$I_R = 100\text{ }\mu\text{A}$
Peak Wavelength						Peak of Wavelength of Spectral Distribution at $I_F = 20\text{ mA}$
Amber			594			
Red-Orange	$\lambda_{\text{PEAK}}$		623		nm	
Red			639			
Spectral Halfwidth	$\Delta\lambda_{1/2}$		17		nm	Wavelength Width at Spectral Distribution $1/2$ Power Point at $I_F = 20\text{ mA}$
Speed of Response	$\tau_s$		20		ns	Exponential Time Constant, $e^{-t/\tau_s}$
Capacitance	C		40		pF	$V_F = 0, f = 1\text{ MHz}$
Thermal Resistance	$R_{\Theta\text{J-PIN}}$		240		$^\circ\text{C/W}$	LED Junction-to-Cathode Lead
Luminous Efficacy <sup>[2]</sup>						Emitted Luminous Power/Emitted Radiant Power at $I_F = 20\text{ mA}$
Amber			500			
Red-Orange	$\eta_v$		235		lm/W	
Red			155			
Luminous Flux	$\phi_v$		1000		mlm	$I_F = 20\text{ mA}$
Luminous Efficiency <sup>[3]</sup>	$\eta_e$					Emitted Luminous Flux/Electrical Power
Amber			22			
Red-Orange			22		lm/W	
Red			21			

#### Notes:

- For options -xxRxx, -xxSxx, -xxTxx, -xxUxx, -xxWxx, -xxYxx, max forward voltage ( $V_f$ ) is 2.6 V. Refer to  $V_f$  bin table.
- The radiant intensity,  $I_e$ , in watts per steradian, may be found from the equation  $I_e = I_v/\eta_v$ , where  $I_v$  is the luminous intensity in candelas and  $\eta_v$  is the luminous efficacy in lumens/watt.
- $\eta_e = \phi_v / I_F \times V_F$ , where  $\phi_v$  is the emitted luminous flux,  $I_F$  is electrical forward current and  $V_F$  is the forward voltage.

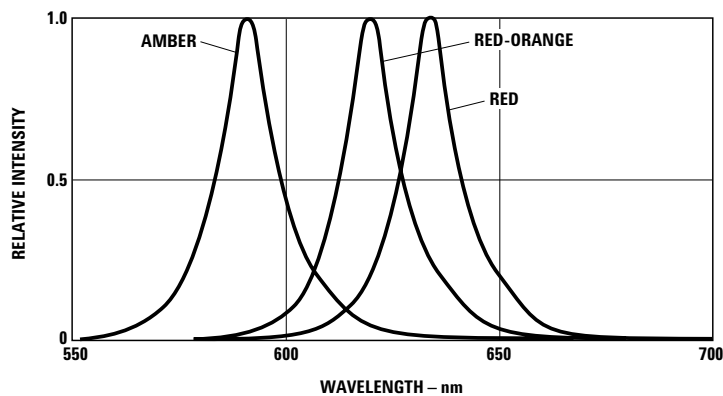

Figure 1. Relative Intensity vs. Peak Wavelength.

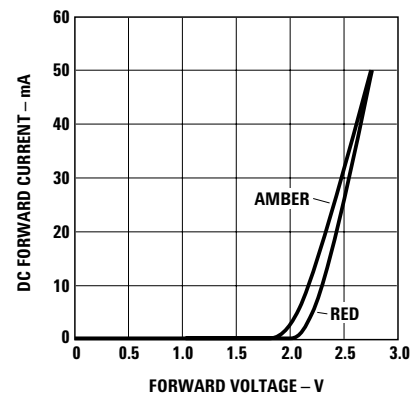

Figure 2a. Forward Current vs. Forward Voltage for Option -xxRxx, -xxSxx, -xxTxx, -xxUxx, -xxWxx and -xxYxx.

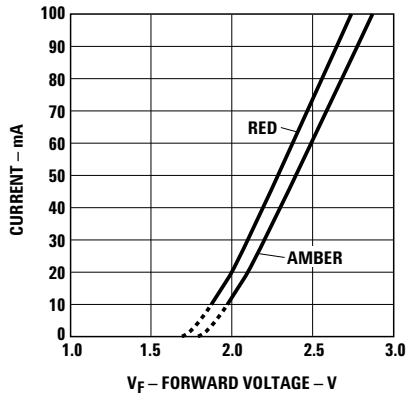

Figure 2b. Forward Current vs. Forward Voltage.

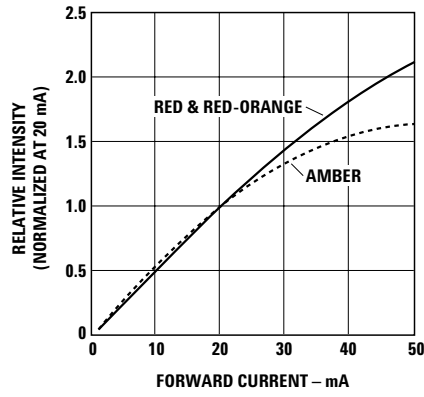

Figure 3. Relative Luminous Intensity vs. Forward Current.

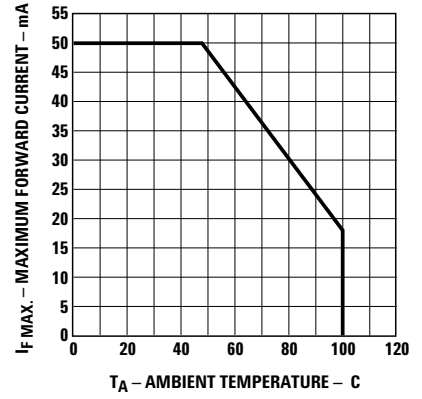

Figure 4. Maximum Forward Current vs. Ambient Temperature. Derating Based on  $T_{JMAX} = 130^{\circ}C$ .

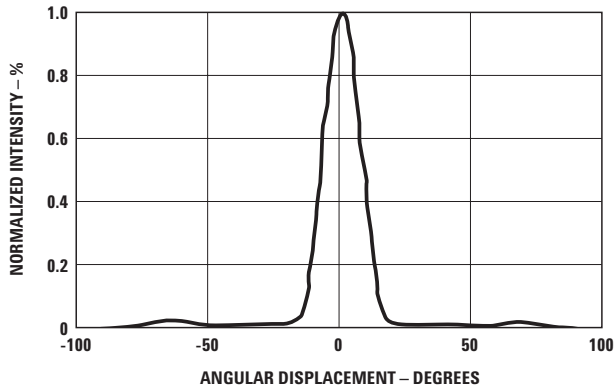

Figure 5. Representative Spatial Radiation Pattern for 15° Viewing Angle Lamps.

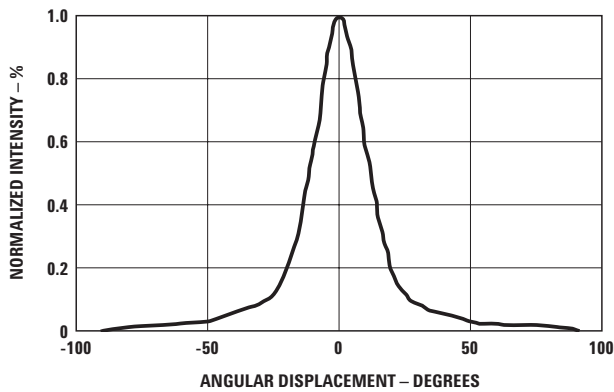

Figure 6. Representative Spatial Radiation Pattern for 23° Viewing Angle Lamps.



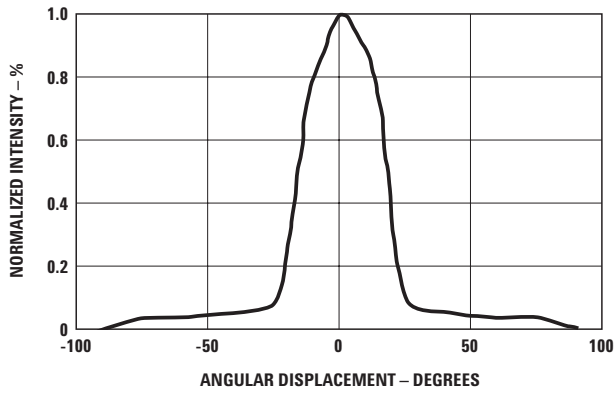

Figure 7. Representative Spatial Radiation Pattern for 30° Viewing Angle Lamps.

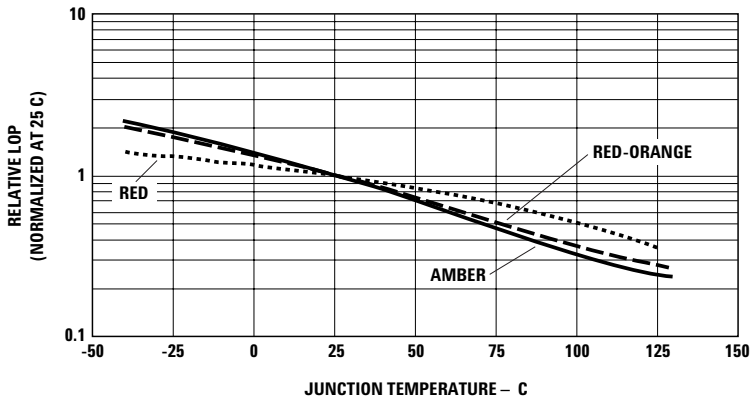

Figure 8. Relative light output vs. junction temperature

**Intensity Bin Limits  
(mcd at 20 mA)**

Bin Name	Min.	Max.
P	880	1150
Q	1150	1500
R	1500	1900
S	1900	2500
T	2500	3200
U	3200	4200
V	4200	5500
W	5500	7200
X	7200	9300
Y	9300	12000
Z	12000	16000

Tolerance for each bin limit is  $\pm 15\%$ .

**Amber Color Bin Limits  
(nm at 20 mA)**

Bin Name	Min.	Max.
1	584.5	587.0
2	587.0	589.5
4	589.5	592.0
6	592.0	594.5

Tolerance for each bin limit is  $\pm 0.5$  nm.

**Notes:**

1. Bin categories are established for classification of products. Products may not be available in all bin categories.
2. Vf Bin table only available for those part number with options -xxRxx, -xxSxx, -xxTxx, -xxUxx, -xxWxx, -xxYxx.

**Vf Bin Table<sup>[2]</sup>**

Bin Name	Min.	Max.
VA	2.0	2.2
VB	2.2	2.4
VC	2.4	2.6

Tolerance for each bin limit is  $\pm 0.05$  V.

**Precautions:**

**Lead Forming:**

- The leads of an LED lamp may be preformed or cut to length prior to insertion and soldering on PC board.
- For better control, it is recommended to use proper tool to precisely form and cut the leads to applicable length rather than doing it manually.
- If manual lead cutting is necessary, cut the leads after the soldering process. The solder connection forms a mechanical ground which prevents mechanical stress due to lead cutting from traveling into LED package. This is highly recommended for hand solder operation, as the excess lead length also acts as small heat sink.

**Soldering and Handling:**

- Care must be taken during PCB assembly and soldering process to prevent damage to the LED component.
- LED component may be effectively hand soldered to PCB. However, it is only recommended under unavoidable circumstances such as rework. The closest manual soldering distance of the soldering heat source (soldering iron's tip) to the body is 1.59mm. Soldering the LED using soldering iron tip closer than 1.59mm might damage the LED.

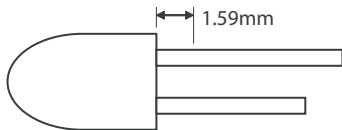

- ESD precaution must be properly applied on the soldering station and personnel to prevent ESD damage to the LED component that is ESD sensitive. Do refer to Avago application note AN 1142 for details. The soldering iron used should have grounded tip to ensure electrostatic charge is properly grounded.
- Recommended soldering condition:

	<b>Wave Soldering</b> [1, 2]	<b>Manual Solder Dipping</b>
Pre-heat temperature	105 °C Max.	-
Preheat time	60 sec Max	-
Peak temperature	250 °C Max.	260 °C Max.
Dwell time	3 sec Max.	5 sec Max

**Note:**

1. Above conditions refers to measurement with thermocouple mounted at the bottom of PCB.
  2. It is recommended to use only bottom preheaters in order to reduce thermal stress experienced by LED.
- Wave soldering parameters must be set and maintained according to the recommended temperature and dwell time. Customer is advised to perform daily check on the soldering profile to ensure that it is always conforming to recommended soldering conditions.

**Note:**

1. PCB with different size and design (component density) will have different heat mass (heat capacity). This might cause a change in temperature experienced by the board if same wave soldering setting is used. So, it is recommended to re-calibrate the soldering profile again before loading a new type of PCB.
2. Avago Technologies' high brightness LED are using high efficiency LED die with single wire bond as shown below. Customer is advised to take extra precaution during wave soldering to ensure that the maximum wave temperature does not exceed 250°C and the solder contact time does not exceeding 3sec. Over-stressing the LED during soldering process might cause premature failure to the LED due to delamination.

**Avago Technologies LED configuration**

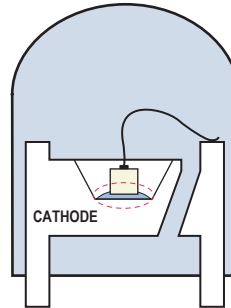

Note: Electrical connection between bottom surface of LED die and the lead frame is achieved through conductive paste.

- Any alignment fixture that is being applied during wave soldering should be loosely fitted and should not apply weight or force on LED. Non metal material is recommended as it will absorb less heat during wave soldering process.
- At elevated temperature, LED is more susceptible to mechanical stress. Therefore, PCB must allowed to cool down to room temperature prior to handling, which includes removal of alignment fixture or pallet.
- If PCB board contains both through hole (TH) LED and other surface mount components, it is recommended that surface mount components be soldered on the top side of the PCB. If surface mount need to be on the bottom side, these components should be soldered using reflow soldering prior to insertion the TH LED.
- Recommended PC board plated through holes (PTH) size for LED component leads.

<b>LED component lead size</b>	<b>Diagonal</b>	<b>Plated through hole diameter</b>
0.45 x 0.45 mm (0.018x 0.018 inch)	0.636 mm (0.025 inch)	0.98 to 1.08 mm (0.039 to 0.043 inch)
0.50 x 0.50 mm (0.020x 0.020 inch)	0.707 mm (0.028 inch)	1.05 to 1.15 mm (0.041 to 0.045 inch)

- Over-sizing the PTH can lead to twisted LED after clinching. On the other hand under sizing the PTH can cause difficulty inserting the TH LED.

Refer to application note AN5334 for more information about soldering and handling of high brightness TH LED lamps.

### Example of Wave Soldering Temperature Profile for TH LED

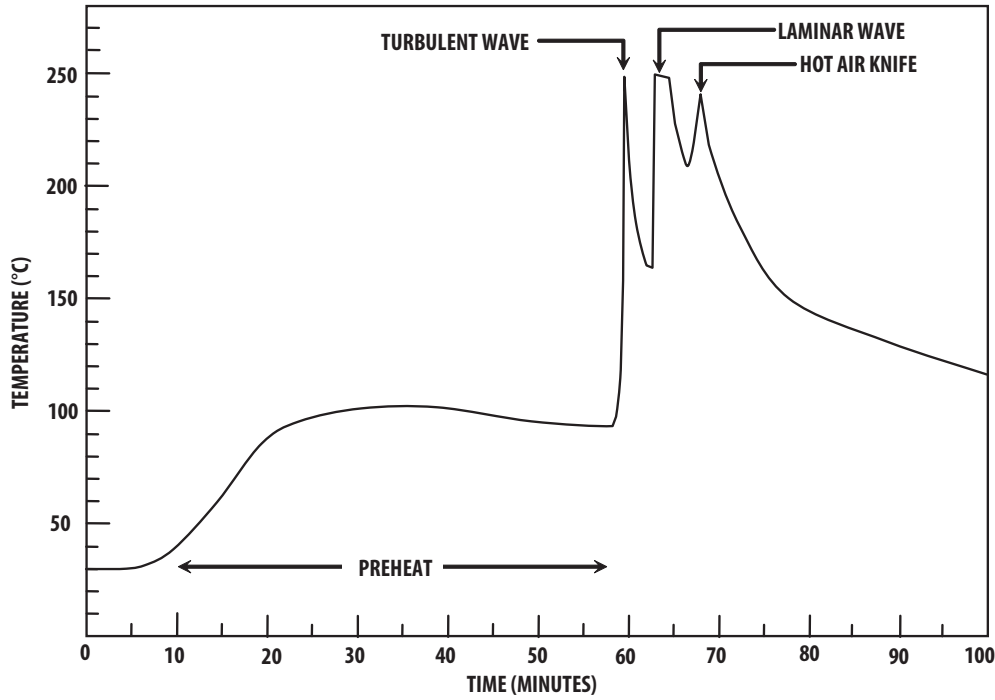

Recommended solder:  
Sn63 (Leaded solder alloy)  
SAC305 (Lead free solder alloy)

Flux: Rosin flux

Solder bath temperature:  
245°C ± 5°C (maximum peak  
temperature = 250°C)

Dwell time: 1.5 sec - 3.0 sec  
(maximum = 3sec)

Note: Allow for board to be  
sufficiently cooled to room  
temperature before exerting  
mechanical force.

### Ammo Pack Drawing

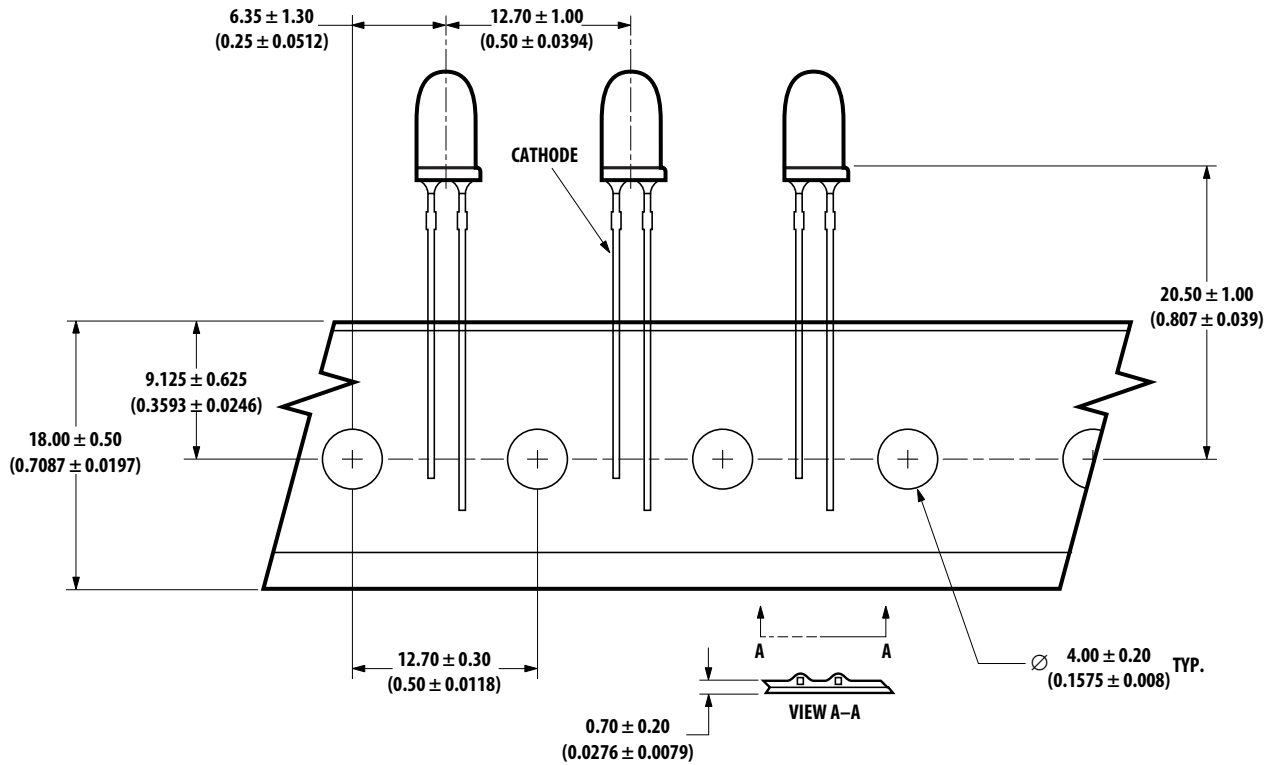

ALL DIMENSIONS IN MILLIMETERS (INCHES).

NOTE: THE AMMO-PACKS DRAWING IS APPLICABLE FOR PACKAGING OPTION -DD & -ZZ AND REGARDLESS OF STANDOFF OR NON-STANDOFF.

## Packaging Box for Ammo Packs

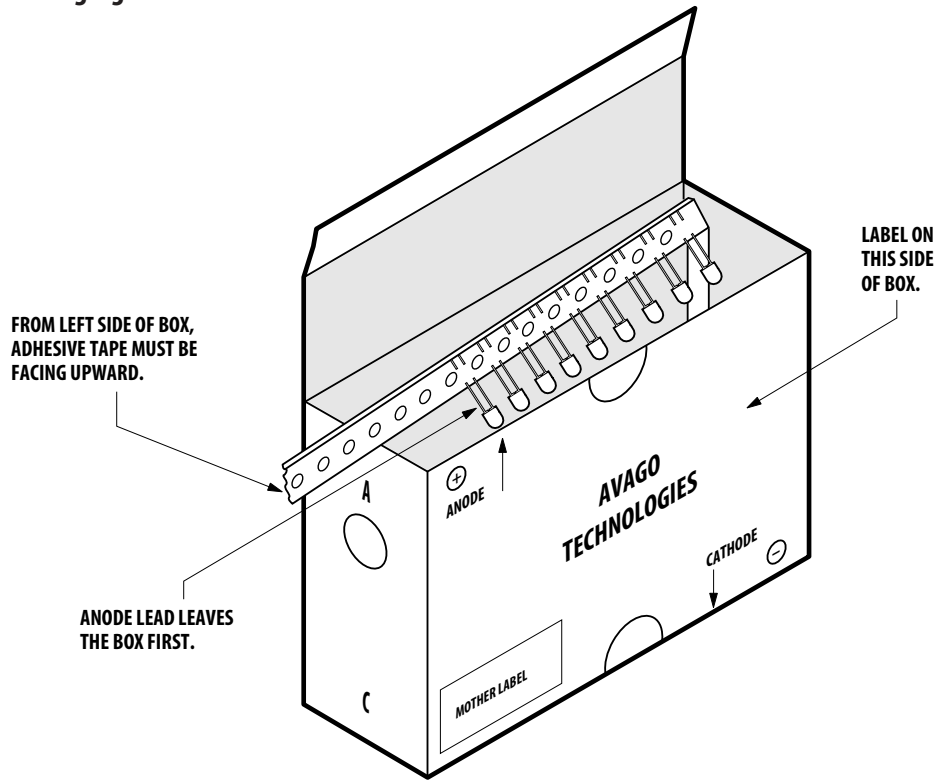











NOTE: THE DIMENSION FOR AMMO PACK IS APPLICABLE FOR THE DEVICE WITH STANDOFF AND WITHOUT STANDOFF.

## Packaging Label:

(i) Avago Mother Label: (Available on packaging box of ammo pack and shipping box)

<p><b>Avago</b> TECHNOLOGIES</p> <p>STANDARD LABEL LS0002 RoHS Compliant e3 max temp 250C</p>	
(1P) Item: <b>Part Number</b> [Barcode]	(Q) QTY: <b>Quantity</b> [Barcode]
(1T) Lot: <b>Lot Number</b> [Barcode]	CAT: <b>Intensity Bin</b> [Barcode]
LPN: [Barcode]	BIN: <b>Refer to below information</b>
(9D)MFG Date: <b>Manufacturing Date</b> [Barcode]	
<hr/>	
(P) Customer Item: [Barcode]	
(V) Vendor ID: [Barcode]	(9D) Date Code: <b>Date Code</b> [Barcode]
DeptID: [Barcode]	Made In: <b>Country of Origin</b> [Barcode]

(ii) Avago Baby Label (Only available on bulk packaging)

 <b>Avago</b> TECHNOLOGIES		RoHS Compliant e3 max temp 250C
<b>Lamps Baby Label</b>		
(1P) PART #: Part Number		
		
(1T) LOT #: Lot Number		
		
(9D)MFG DATE: Manufacturing Date	QUANTITY: Packing Quantity	
		
C/O: Country of Origin		
Customer P/N:	CAT: Intensity Bin	
		
Supplier Code:	BIN: Refer to below information	
		
	DATECODE: Date Code	
		

**Acronyms and Definition:**

BIN:

(i) Color bin only or VF bin only

(Applicable for part number with color bins but without VF bin OR part number with VF bins and no color bin)

OR

(ii) Color bin incorporated with VF Bin

(Applicable for part number that have both color bin and VF bin)

Example:

(i) Color bin only or VF bin only

BIN: 2 (represent color bin 2 only)

BIN: VB (represent VF bin "VB" only)

(ii) Color bin incorporate with VF Bin

BIN: 2VB

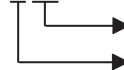

VB: VF bin "VB"

2: Color bin 2 only

**DISCLAIMER:** AVAGO'S PRODUCTS AND SOFTWARE ARE NOT SPECIFICALLY DESIGNED, MANUFACTURED OR AUTHORIZED FOR SALE AS PARTS, COMPONENTS OR ASSEMBLIES FOR THE PLANNING, CONSTRUCTION, MAINTENANCE OR DIRECT OPERATION OF A NUCLEAR FACILITY OR FOR USE IN MEDICAL DEVICES OR APPLICATIONS. CUSTOMER IS SOLELY RESPONSIBLE, AND WAIVES ALL RIGHTS TO MAKE CLAIMS AGAINST AVAGO OR ITS SUPPLIERS, FOR ALL LOSS, DAMAGE, EXPENSE OR LIABILITY IN CONNECTION WITH SUCH USE.

For product information and a complete list of distributors, please go to our website: [www.avagotech.com](http://www.avagotech.com)

Avago, Avago Technologies, and the A logo are trademarks of Avago Technologies in the United States and other countries. Data subject to change. Copyright © 2005-2009 Avago Technologies. All rights reserved. Obsoletes AV01-0701EN AV02-342EN - January 15, 2009



## Данный компонент на территории Российской Федерации

### Вы можете приобрести в компании MosChip.

Для оперативного оформления запроса Вам необходимо перейти по данной ссылке:

<http://moschip.ru/get-element>

Вы можете разместить у нас заказ для любого Вашего проекта, будь то серийное производство или разработка единичного прибора.

В нашем ассортименте представлены ведущие мировые производители активных и пассивных электронных компонентов.

Нашей специализацией является поставка электронной компонентной базы двойного назначения, продукции таких производителей как XILINX, Intel (ex.ALTERA), Vicor, Microchip, Texas Instruments, Analog Devices, Mini-Circuits, Amphenol, Glenair.

Сотрудничество с глобальными дистрибьюторами электронных компонентов, предоставляет возможность заказывать и получать с международных складов практически любой перечень компонентов в оптимальные для Вас сроки.

На всех этапах разработки и производства наши партнеры могут получить квалифицированную поддержку опытных инженеров.

Система менеджмента качества компании отвечает требованиям в соответствии с ГОСТ Р ИСО 9001, ГОСТ РВ 0015-002 и ЭС РД 009

### Офис по работе с юридическими лицами:

105318, г.Москва, ул.Щербаковская д.3, офис 1107, 1118, ДЦ «Щербаковский»

Телефон: +7 495 668-12-70 (многоканальный)

Факс: +7 495 668-12-70 (доб.304)

E-mail: [info@moschip.ru](mailto:info@moschip.ru)

Skype отдела продаж:

moschip.ru

moschip.ru\_4

moschip.ru\_6

moschip.ru\_9