

HEXFRED®

Ultrafast Soft Recovery Diode, 140 A



SOT-227

FEATURES

- Fast recovery time characteristic
- Electrically isolated base plate
- Large creepage distance between terminal
- Simplified mechanical designs, rapid assembly
- Designed and qualified for industrial level
- UL approved file E78996
- Material categorization: For definitions of compliance please see www.vishay.com/doc?99912



RoHS
COMPLIANT

| PRODUCT SUMMARY | |
|-----------------------------------|----------------|
| V_R | 1200 V |
| V_F (typical) | 2.8 V |
| t_{rr} (typical) | 48 ns |
| $I_{F(DC)}$ at T_C , per module | 140 A at 74 °C |
| $I_{F(AV)}$ at T_C , per module | 140 A at 46 °C |

DESCRIPTION/APPLICATIONS

The dual diode series configuration VS-HFA140FA120 is used for output rectification or freewheeling/clamping operation and high voltage application. The semiconductor in the SOT-227 package is isolated from the copper base plate, allowing for common heatsinks and compact assemblies to be built. These modules are intended for general applications such as HV power supplies, electronic welders, motor control and inverters.

| ABSOLUTE MAXIMUM RATINGS | | | | |
|--|----------------|--------------------------------------|---------------|-------|
| PARAMETER | SYMBOL | TEST CONDITIONS | MAX. | UNITS |
| Cathode to anode voltage | V_R | | 1200 | V |
| Continuous forward current | I_F | $T_C = 74\text{ °C}$ | 70 | A |
| | | | 140 | |
| Single pulse forward current | I_{FSM} | $T_J = 25\text{ °C}$ | 350 | |
| Maximum power dissipation, per leg | P_D | $T_C = 25\text{ °C}$ | 357 | W |
| | | $T_C = 100\text{ °C}$ | 143 | |
| RMS isolation voltage | V_{ISOL} | Any terminal to case, $t = 1$ minute | 2500 | V |
| Operating junction and storage temperature range | T_J, T_{Stg} | | - 55 to + 150 | °C |

| ELECTRICAL SPECIFICATIONS ($T_J = 25\text{ °C}$ unless otherwise specified) | | | | | | |
|--|----------|--|------|------|------|---------------|
| PARAMETER | SYMBOL | TEST CONDITIONS | MIN. | TYP. | MAX. | UNITS |
| Cathode to anode breakdown voltage | V_{BR} | $I_R = 100\text{ }\mu\text{A}$ | 1200 | - | - | V |
| Forward voltage, per leg | V_{FM} | $I_F = 60\text{ A}$ | - | 2.8 | 4.0 | |
| | | $I_F = 120\text{ A}$ | - | 3.6 | 5.3 | |
| | | $I_F = 60\text{ A}, T_J = 125\text{ °C}$ | - | 2.7 | - | |
| | | $I_F = 60\text{ A}, T_J = 150\text{ °C}$ | - | 2.65 | - | |
| Reverse leakage current, per leg | I_{RM} | $V_R = V_R$ rated | - | 2.0 | 75 | μA |
| | | $T_J = 125\text{ °C}, V_R = V_R$ rated | - | 1.6 | 5 | mA |
| | | $T_J = 150\text{ °C}, V_R = V_R$ rated | - | 5 | 10 | |



| DYNAMIC RECOVERY CHARACTERISTICS ($T_J = 25\text{ }^\circ\text{C}$ unless otherwise specified) | | | | | | |
|--|-----------|---|------|------|------|-------|
| PARAMETER | SYMBOL | TEST CONDITIONS | MIN. | TYP. | MAX. | UNITS |
| Reverse recovery time, per leg | t_{rr} | $I_F = 1\text{ A}$; $di_F/dt = 200\text{ A}/\mu\text{s}$; $V_R = 30\text{ V}$ | - | 48 | - | ns |
| | | $T_J = 25\text{ }^\circ\text{C}$ | - | 145 | - | |
| | | $T_J = 125\text{ }^\circ\text{C}$ | - | 218 | - | |
| Peak recovery current, per leg | I_{RRM} | $T_J = 25\text{ }^\circ\text{C}$ | - | 13 | - | A |
| | | $T_J = 125\text{ }^\circ\text{C}$ | - | 18 | - | |
| Reverse recovery charge, per leg | Q_{rr} | $T_J = 25\text{ }^\circ\text{C}$ | - | 910 | - | nC |
| | | $T_J = 125\text{ }^\circ\text{C}$ | - | 1920 | - | |
| Junction capacitance, per leg | C_T | $V_R = 1200\text{ V}$ | - | 27 | - | pF |

| THERMAL - MECHANICAL SPECIFICATIONS | | | | | | |
|--|------------|---------------------------|------|------|-------|---------------------------|
| PARAMETER | SYMBOL | TEST CONDITIONS | MIN. | TYP. | MAX. | UNITS |
| Junction to case, single leg conducting | R_{thJC} | | - | - | 0.35 | $^\circ\text{C}/\text{W}$ |
| Junction to case, both legs conducting | | | - | - | 0.175 | |
| Case to heatsink, per leg | R_{thCS} | Flat, greased and surface | - | 0.05 | - | |
| Weight | | | - | 30 | - | g |
| Mounting torque, on terminals and heatsink | T | | - | - | 1.3 | Nm |

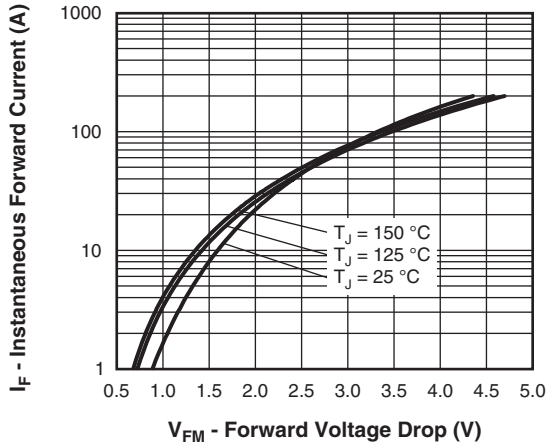

Fig. 1 - Typical Forward Voltage Drop Characteristics

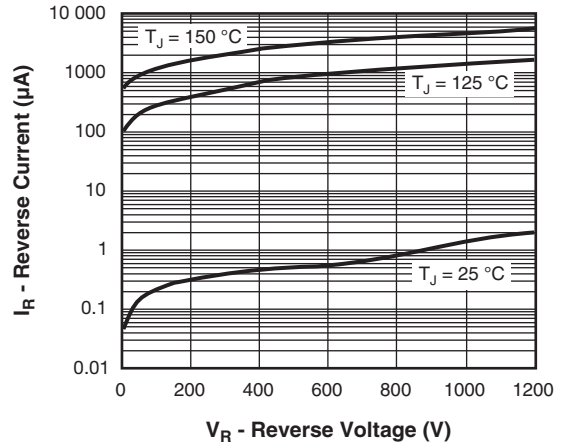

Fig. 2 - Typical Values of Reverse Current vs. Reverse Voltage

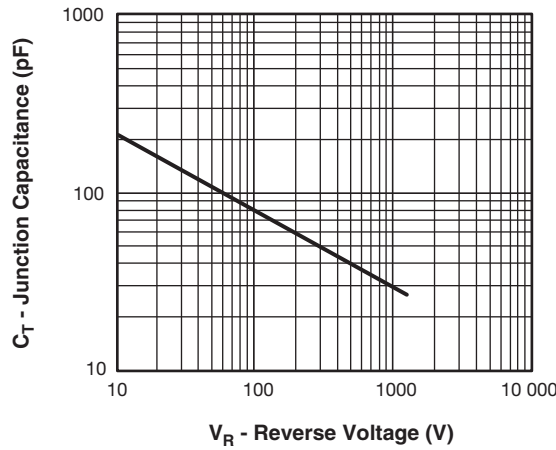

Fig. 3 - Typical Junction Capacitance vs. Reverse Voltage

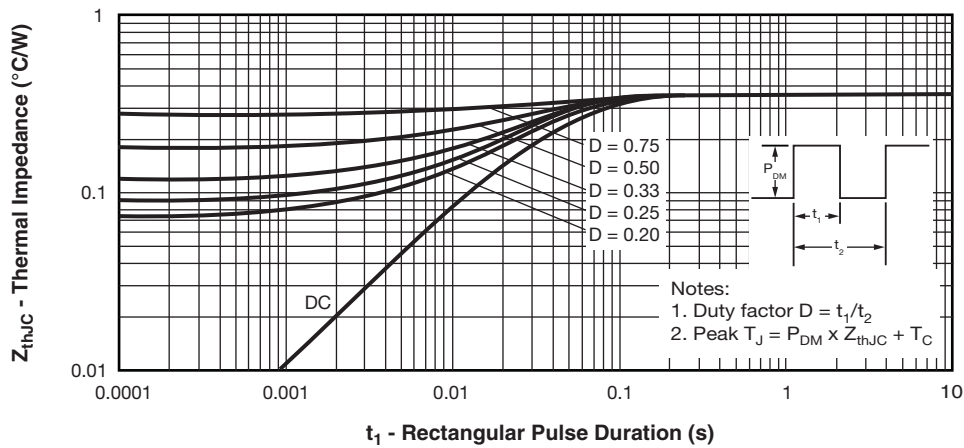

Fig. 4 - Maximum Thermal Impedance Z_{thJC} Characteristics (Per Leg)

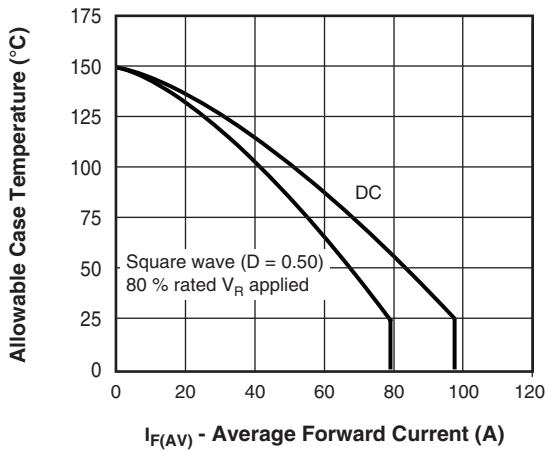

Fig. 5 - Maximum Allowable Case Temperature vs. Average Forward Current

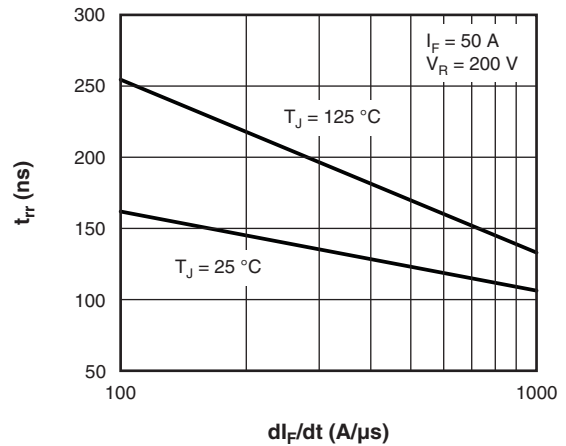

Fig. 7 - Typical Reverse Recovery Time vs. dI_F/dt

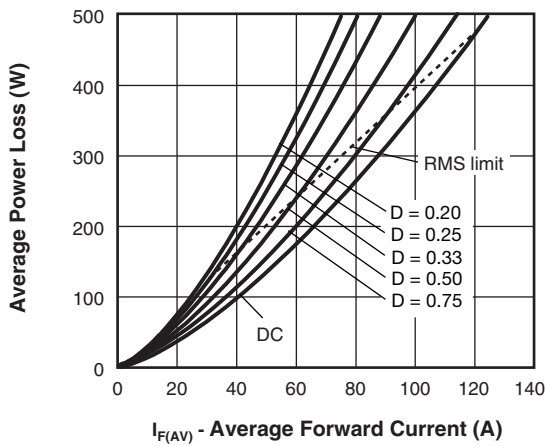

Fig. 6 - Forward Power Loss Characteristics

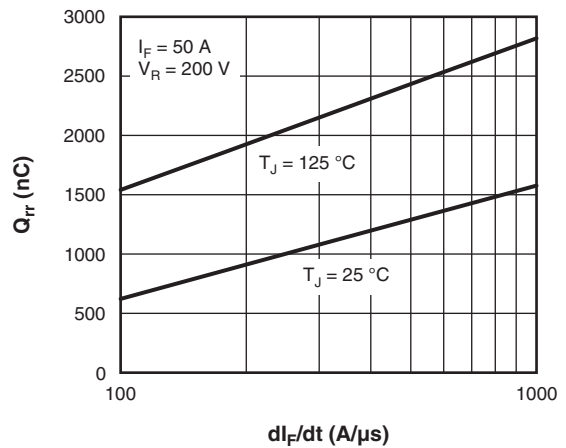

Fig. 8 - Typical Stored Charge vs. dI_F/dt

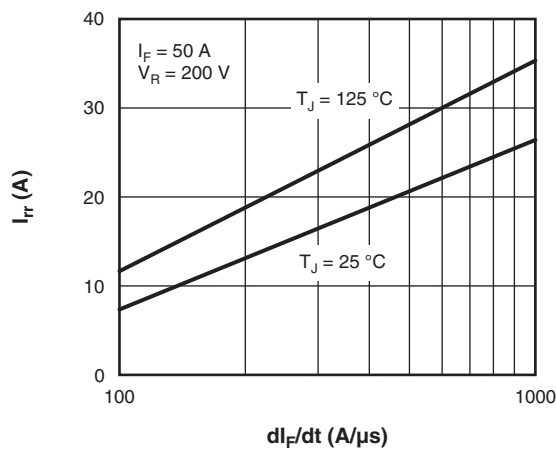

Fig. 9 - Typical Peak Recovery Current vs. dI_F/dt

Note

- (1) Formula used: $T_C = T_J - (P_d + P_{d_{REV}}) \times R_{thJC}$;
- P_d = Forward power loss = $I_{F(AV)} \times V_{FM}$ at $(I_{F(AV)}/D)$ (see fig. 5);
- $P_{d_{REV}}$ = Inverse power loss = $V_{R1} \times I_R (1 - D)$; I_R at V_{R1} = Rated V_R

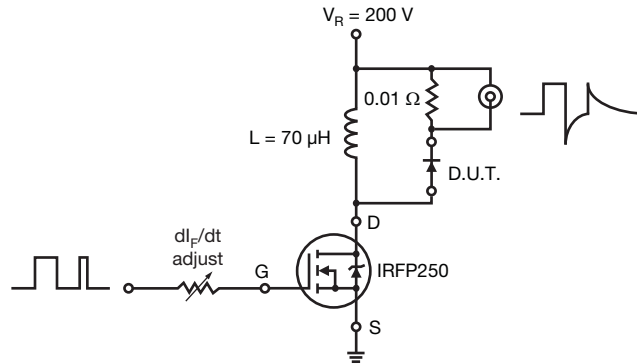
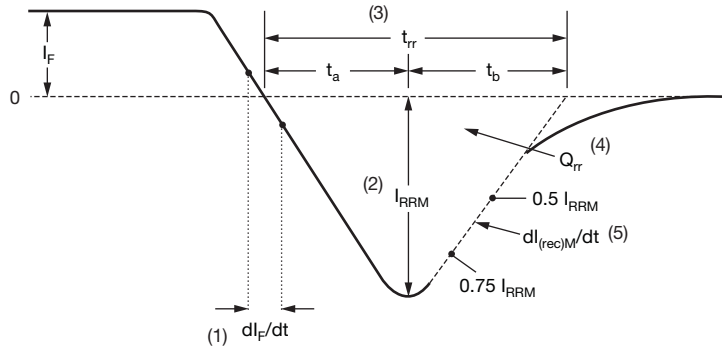

Fig. 10 - Reverse Recovery Parameter Test Circuit



(1) di_F/dt - rate of change of current through zero crossing

(2) I_{RRM} - peak reverse recovery current

(3) t_{rr} - reverse recovery time measured from zero crossing point of negative going I_F to point where a line passing through $0.75 I_{RRM}$ and $0.50 I_{RRM}$ extrapolated to zero current.

(4) Q_{rr} - area under curve defined by t_{rr} and I_{RRM}

$$Q_{rr} = \frac{t_{rr} \times I_{RRM}}{2}$$

(5) $di_{(rec)M}/dt$ - peak rate of change of current during t_b portion of t_{rr}

Fig. 11 - Reverse Recovery Waveform and Definitions

ORDERING INFORMATION TABLE

| | | | | | | | |
|-------------|------------|-----------|----------|------------|----------|----------|------------|
| Device code | VS- | HF | A | 140 | F | A | 120 |
| | ① | ② | ③ | ④ | ⑤ | ⑥ | ⑦ |

- 1** - Vishay Semiconductors product
- 2** - HEXFRED® family
- 3** - Process designator (A = Electron irradiated)
- 4** - Average current (140 = 140 A)
- 5** - Circuit configuration (2 separate diodes, parallel pin-out)
- 6** - Package indicator (SOT-227 standard isolated base)
- 7** - Voltage rating (120 = 1200 V)

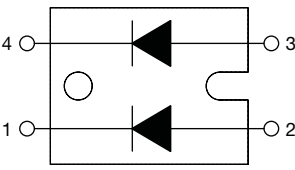
| CIRCUIT CONFIGURATION | | |
|-------------------------------------|----------------------------|--|
| CIRCUIT | CIRCUIT CONFIGURATION CODE | CIRCUIT DRAWING |
| 2 separate diodes, parallel pin-out | F |  |

| LINKS TO RELATED DOCUMENTS | |
|----------------------------|--|
| Dimensions | www.vishay.com/doc?95423 |
| Part marking information | www.vishay.com/doc?95425 |



Disclaimer

ALL PRODUCT, PRODUCT SPECIFICATIONS AND DATA ARE SUBJECT TO CHANGE WITHOUT NOTICE TO IMPROVE RELIABILITY, FUNCTION OR DESIGN OR OTHERWISE.

Vishay Intertechnology, Inc., its affiliates, agents, and employees, and all persons acting on its or their behalf (collectively, "Vishay"), disclaim any and all liability for any errors, inaccuracies or incompleteness contained in any datasheet or in any other disclosure relating to any product.

Vishay makes no warranty, representation or guarantee regarding the suitability of the products for any particular purpose or the continuing production of any product. To the maximum extent permitted by applicable law, Vishay disclaims (i) any and all liability arising out of the application or use of any product, (ii) any and all liability, including without limitation special, consequential or incidental damages, and (iii) any and all implied warranties, including warranties of fitness for particular purpose, non-infringement and merchantability.

Statements regarding the suitability of products for certain types of applications are based on Vishay's knowledge of typical requirements that are often placed on Vishay products in generic applications. Such statements are not binding statements about the suitability of products for a particular application. It is the customer's responsibility to validate that a particular product with the properties described in the product specification is suitable for use in a particular application. Parameters provided in datasheets and/or specifications may vary in different applications and performance may vary over time. All operating parameters, including typical parameters, must be validated for each customer application by the customer's technical experts. Product specifications do not expand or otherwise modify Vishay's terms and conditions of purchase, including but not limited to the warranty expressed therein.

Except as expressly indicated in writing, Vishay products are not designed for use in medical, life-saving, or life-sustaining applications or for any other application in which the failure of the Vishay product could result in personal injury or death. Customers using or selling Vishay products not expressly indicated for use in such applications do so at their own risk. Please contact authorized Vishay personnel to obtain written terms and conditions regarding products designed for such applications.

No license, express or implied, by estoppel or otherwise, to any intellectual property rights is granted by this document or by any conduct of Vishay. Product names and markings noted herein may be trademarks of their respective owners.

Material Category Policy

Vishay Intertechnology, Inc. hereby certifies that all its products that are identified as RoHS-Compliant fulfill the definitions and restrictions defined under Directive 2011/65/EU of The European Parliament and of the Council of June 8, 2011 on the restriction of the use of certain hazardous substances in electrical and electronic equipment (EEE) - recast, unless otherwise specified as non-compliant.

Please note that some Vishay documentation may still make reference to RoHS Directive 2002/95/EC. We confirm that all the products identified as being compliant to Directive 2002/95/EC conform to Directive 2011/65/EU.

Vishay Intertechnology, Inc. hereby certifies that all its products that are identified as Halogen-Free follow Halogen-Free requirements as per JEDEC JS709A standards. Please note that some Vishay documentation may still make reference to the IEC 61249-2-21 definition. We confirm that all the products identified as being compliant to IEC 61249-2-21 conform to JEDEC JS709A standards.

Данный компонент на территории Российской Федерации

Вы можете приобрести в компании MosChip.

Для оперативного оформления запроса Вам необходимо перейти по данной ссылке:

<http://moschip.ru/get-element>

Вы можете разместить у нас заказ для любого Вашего проекта, будь то серийное производство или разработка единичного прибора.

В нашем ассортименте представлены ведущие мировые производители активных и пассивных электронных компонентов.

Нашей специализацией является поставка электронной компонентной базы двойного назначения, продукции таких производителей как XILINX, Intel (ex.ALTERA), Vicor, Microchip, Texas Instruments, Analog Devices, Mini-Circuits, Amphenol, Glenair.

Сотрудничество с глобальными дистрибьюторами электронных компонентов, предоставляет возможность заказывать и получать с международных складов практически любой перечень компонентов в оптимальные для Вас сроки.

На всех этапах разработки и производства наши партнеры могут получить квалифицированную поддержку опытных инженеров.

Система менеджмента качества компании отвечает требованиям в соответствии с ГОСТ Р ИСО 9001, ГОСТ РВ 0015-002 и ЭС РД 009

Офис по работе с юридическими лицами:

105318, г.Москва, ул.Щербаковская д.3, офис 1107, 1118, ДЦ «Щербаковский»

Телефон: +7 495 668-12-70 (многоканальный)

Факс: +7 495 668-12-70 (доб.304)

E-mail: info@moschip.ru

Skype отдела продаж:

moschip.ru

moschip.ru_4

moschip.ru_6

moschip.ru_9