

Turbo 2 ultrafast high voltage rectifier

Features

- Ultrafast switching
- Low reverse recovery current
- Reduces switching and conduction losses
- Low thermal resistance

Description

The STTH16L06, which is using ST Turbo 2 600 V technology, is specially suited for use in switching power supplies, and industrial applications, as rectification and discontinuous mode PFC boost diode.

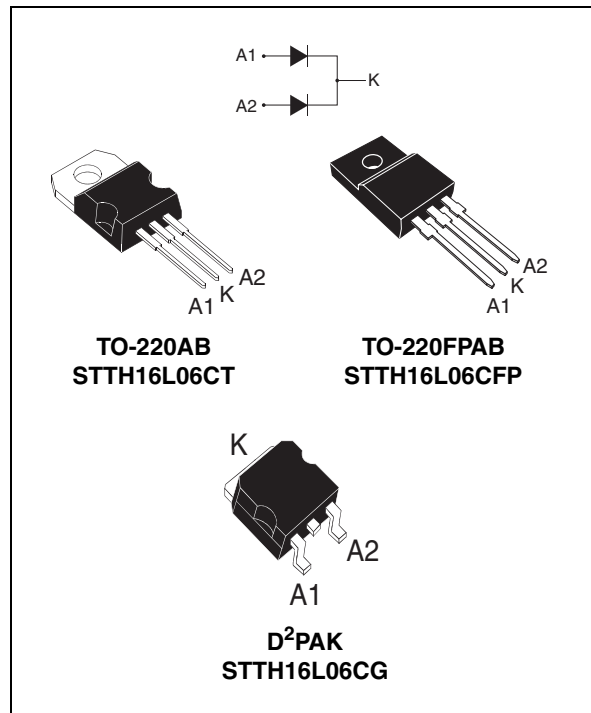

Table 1. Device summary

$I_{F(AV)}$	Up to 2 x 10 A
V_{RRM}	600 V
T_j	175 °C
V_F (typ)	1.05 V
t_{rr} (max)	35 ns

1 Characteristics

Table 2. Absolute ratings (limiting values)

Symbol	Parameter			Value	Unit	
V _{RRM}	Repetitive peak reverse voltage			600	V	
I _{F(RMS)}	Forward rms current			30	A	
I _{F(AV)}	Average forward current δ = 0.5	TO-220AB / D ² PAK	T _c = 140 °C	Per diode	8	A
			T _c = 135 °C	Per device	16	
			T _c = 130 °C	Per diode	10	
			T _c = 120 °C	Per device	20	
		TO-220FPAB	T _c = 110 °C	Per diode	8	
			T _c = 80 °C	Per device	16	
I _{FSM}	Surge non repetitive forward current		t _p = 10 ms sinusoidal	120	A	
T _{stg}	Storage temperature range			-65 to + 175	°C	
T _j	Maximum operating junction temperature			175	°C	

Table 3. Thermal resistance

Symbol	Parameter			Maximum	Unit
R _{th(j-c)}	Junction to case	TO-220AB / D ² PAK	Per diode	2.5	°C/ W
		TO-220FPAB	Per diode	5	
		TO-220AB / D ² PAK	Total	1.6	
		TO-220FPAB	Total	3.8	
R _{th(c)}	Coupling	TO-220AB / D ² PAK		0.7	°C/ W
		TO-220FPAB		2.5	

When the diodes 1 and 2 are used simultaneously:

$$\Delta T_{j(\text{diode1})} = P_{(\text{diode1})} \times R_{th(j-c)} (\text{per diode}) + P_{(\text{diode2})} \times R_{th(c)}$$

Table 4. Static electrical characteristics

Symbol	Parameter	Test conditions		Min.	Typ	Max.	Unit
I _R ⁽¹⁾	Reverse leakage current	T _j = 25 °C	V _R = V _{RRM}			8	μA
		T _j = 150 °C			25	240	
V _F ⁽²⁾	Forward voltage drop	T _j = 25 °C	I _F = 8 A			1.8	V
		T _j = 150 °C			1.05	1.35	
		T _j = 25 °C	I _F = 16 A			2.08	
		T _j = 150 °C			1.28	1.64	

1. Pulse test: t_p = 5 ms, δ < 2 %

2. Pulse test: t_p = 380 μs, δ < 2 %

To evaluate the maximum conduction losses use the following equation:

$$P = 1.06 \times I_{F(AV)} + 0.036 I_{F(RMS)}^2$$

Table 5. Dynamic electrical characteristics

Symbol	Parameter	Test conditions		Min.	Typ	Max.	Unit
t_{rr}	Reverse recovery time	$T_j = 25\text{ }^\circ\text{C}$	$I_F = 0.5\text{ A}, I_{rr} = 0.25\text{ A}, I_R = 1\text{ A}$			35	ns
			$I_F = 1\text{ A}, dI_F/dt = 50\text{ A}/\mu\text{s}, V_R = 30\text{ V}$		40	55	
I_{RM}	Reverse recovery current	$T_j = 125\text{ }^\circ\text{C}$	$I_F = 8\text{ A}, dI_F/dt = 100\text{ A}/\mu\text{s}, V_R = 400\text{ V}$		4.5	6.5	A
t_{fr}	Forward recovery time	$T_j = 25\text{ }^\circ\text{C}$	$I_F = 8\text{ A}, dI_F/dt = 100\text{ A}/\mu\text{s}, V_{FR} = 1.1 \times V_{Fmax}$			200	ns
V_{FP}	Forward recovery voltage				3.5		V

Figure 1. Conduction losses versus average current

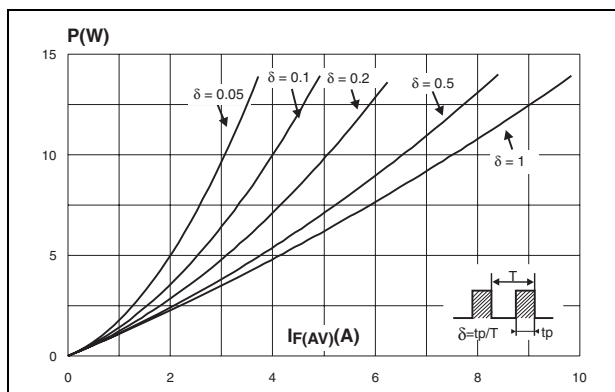

Figure 2. Forward voltage drop versus forward current

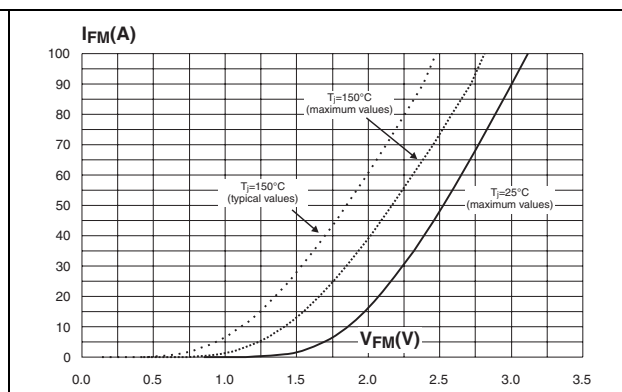

Figure 3. Relative variation of thermal impedance junction to case versus pulse duration (TO-220AB, D²PAK)

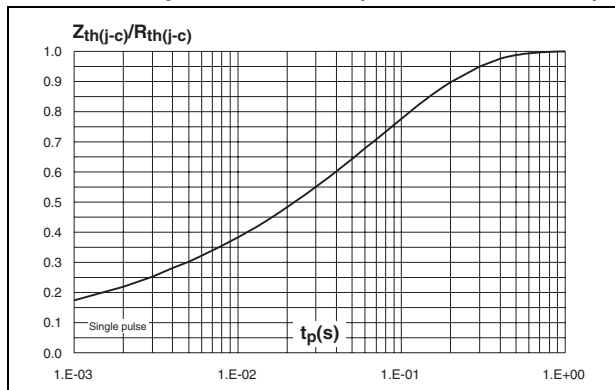

Figure 4. Relative variation of thermal impedance junction to case versus pulse duration (TO-220FPAB)

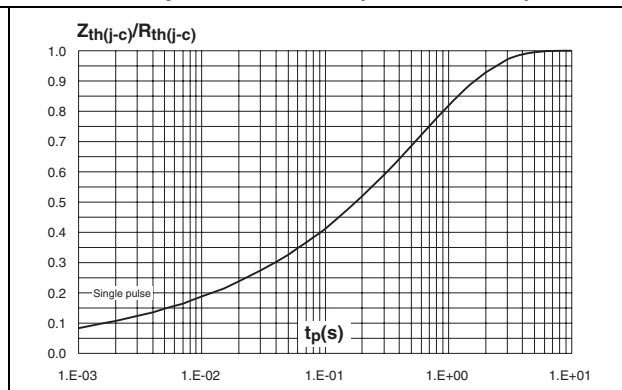

Figure 5. Peak reverse recovery current versus di_F/dt (typical values, per diode)

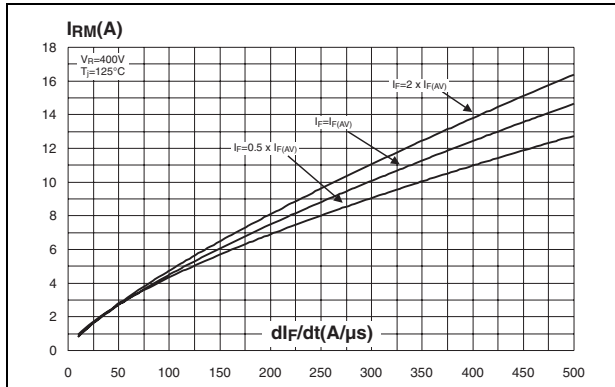

Figure 6. Reverse recovery time versus di_F/dt (typical values, per diode)

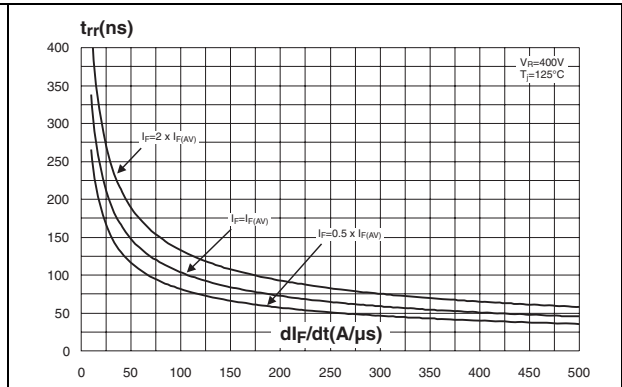

Figure 7. Reverse recovery charges versus di_F/dt (typical values, per diode)

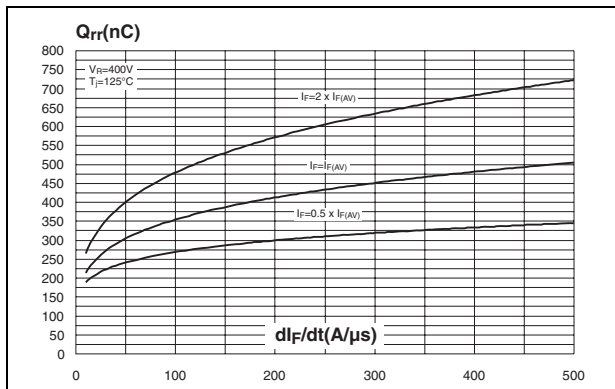

Figure 8. Reverse recovery softness factor versus di_F/dt (typical values, per diode)

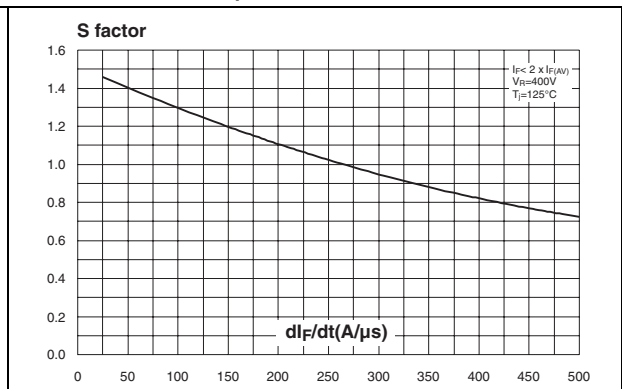

Figure 9. Relative variations of dynamic parameters versus junction temperature

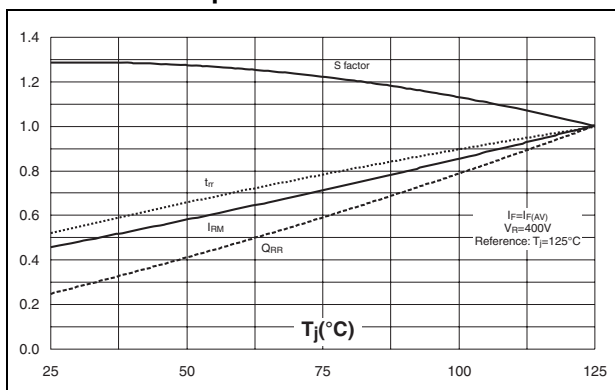

Figure 10. Transient peak forward voltage versus di_F/dt (typical values, per diode)

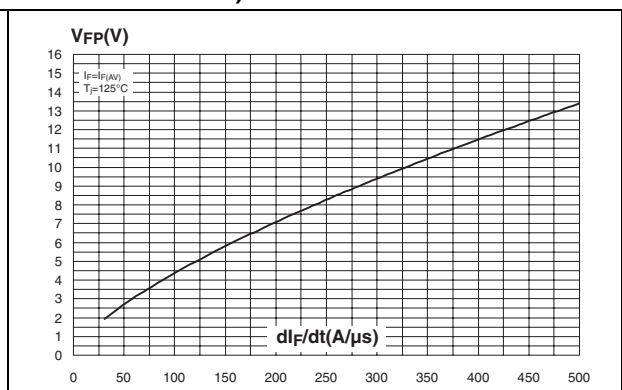

Figure 11. Forward recovery time versus di_F/dt (typical values, per diode) **Figure 12. Junction capacitance versus reverse voltage applied (typical values, per diode)**

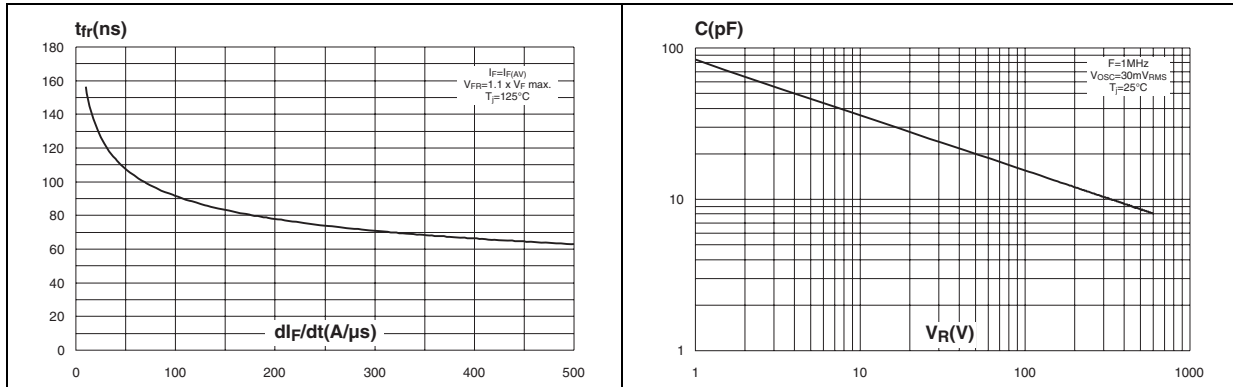
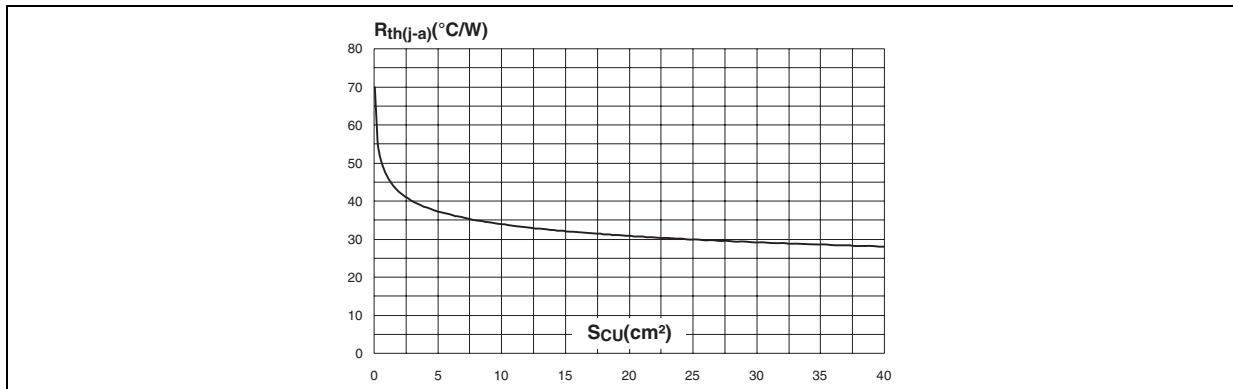

Figure 13. Thermal resistance junction to ambient versus copper surface under tab (epoxy FR4, copper thickness = 35 μ m) (D²PAK)



2 Package mechanical data

- Epoxy meets UL94, V0
- Cooling method: by conduction (C)
- Recommended torque value: 0.4 to 0.6 N·m

In order to meet environmental requirements, ST offers these devices in different grades of ECOPACK® packages, depending on their level of environmental compliance. ECOPACK® specifications, grade definitions and product status are available at: www.st.com. ECOPACK® is an ST trademark.

Table 6. TO-220AB dimensions

Ref.	dimensions			
	Millimeters		Inches	
	Min.	Max.	Min.	Max.
A	4.40	4.60	0.173	0.181
C	1.23	1.32	0.048	0.051
D	2.40	2.72	0.094	0.107
E	0.49	0.70	0.019	0.027
F	0.61	0.88	0.024	0.034
F1	1.14	1.70	0.044	0.066
F2	1.14	1.70	0.044	0.066
G	4.95	5.15	0.194	0.202
G1	2.40	2.70	0.094	0.106
H2	10	10.40	0.393	0.409
L2	16.4 typ.		0.645 typ.	
L4	13	14	0.511	0.551
L5	2.65	2.95	0.104	0.116
L6	15.25	15.75	0.600	0.620
L7	6.20	6.60	0.244	0.259
L9	3.50	3.93	0.137	0.154
M	2.6 typ.		0.102 typ.	
Diam.	3.75	3.85	0.147	0.151

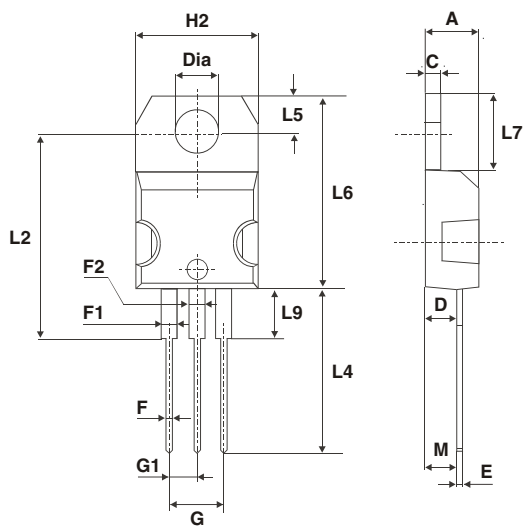

Table 7. TO-220FPAB dimensions

Ref.	dimensions			
	Millimeters		Inches	
	Min.	Max.	Min.	Max.
A	4.4	4.6	0.173	0.181
B	2.5	2.7	0.098	0.106
D	2.5	2.75	0.098	0.108
E	0.45	0.70	0.018	0.027
F	0.75	1	0.030	0.039
F1	1.15	1.70	0.045	0.067
F2	1.15	1.70	0.045	0.067
G	4.95	5.20	0.195	0.205
G1	2.4	2.7	0.094	0.106
H	10	10.4	0.393	0.409
L2	16 Typ.		0.63 Typ.	
L3	28.6	30.6	1.126	1.205
L4	9.8	10.6	0.386	0.417
L5	2.9	3.6	0.114	0.142
L6	15.9	16.4	0.626	0.646
L7	9.00	9.30	0.354	0.366
Dia.	3.00	3.20	0.118	0.126

Table 8. D²PAK dimensions

Ref.	dimensions			
	Millimeters		Inches	
	Min.	Max.	Min.	Max.
A	4.40	4.60	0.173	0.181
A1	2.49	2.69	0.098	0.106
A2	0.03	0.23	0.001	0.009
B	0.70	0.93	0.027	0.037
B2	1.14	1.70	0.045	0.067
C	0.45	0.60	0.017	0.024
C2	1.23	1.36	0.048	0.054
D	8.95	9.35	0.352	0.368
E	10.00	10.40	0.393	0.409
G	4.88	5.28	0.192	0.208
L	15.00	15.85	0.590	0.624
L2	1.27	1.40	0.050	0.055
L3	1.40	1.75	0.055	0.069
M	2.40	3.20	0.094	0.126
R	0.40 typ.		0.016 typ.	
V2	0°	8°	0°	8°

Figure 14. Footprint (dimensions in mm)

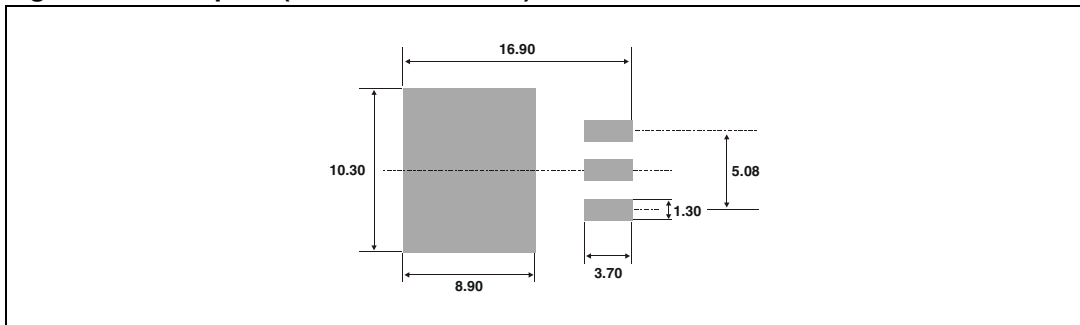

3 Ordering information

Table 9. Ordering information

Order code	Marking	Package	Weight	Base qty	Delivery mode
STTH16L06CT	STTH16L06CT	TO-220AB	2.23 g	50	Tube
STTH16L06CG	STTH16L06CG	D ² PAK	1.48 g	50	Tube
STTH16L06CG-TR	STTH16L06CG	D ² PAK	1.48 g	1000	Tape and reel
STTH16L06CFP	STTH16L06CFP	TO-220FPAB	1.70 g	50	Tube

4 Revision history

Table 10. Document revision history

Date	Revision	Description of Changes
07-Sep-2004	1	First issue
07-Apr-2011	2	Updated ECOPACK statement.

Please Read Carefully:

Information in this document is provided solely in connection with ST products. STMicroelectronics NV and its subsidiaries ("ST") reserve the right to make changes, corrections, modifications or improvements, to this document, and the products and services described herein at any time, without notice.

All ST products are sold pursuant to ST's terms and conditions of sale.

Purchasers are solely responsible for the choice, selection and use of the ST products and services described herein, and ST assumes no liability whatsoever relating to the choice, selection or use of the ST products and services described herein.

No license, express or implied, by estoppel or otherwise, to any intellectual property rights is granted under this document. If any part of this document refers to any third party products or services it shall not be deemed a license grant by ST for the use of such third party products or services, or any intellectual property contained therein or considered as a warranty covering the use in any manner whatsoever of such third party products or services or any intellectual property contained therein.

UNLESS OTHERWISE SET FORTH IN ST'S TERMS AND CONDITIONS OF SALE ST DISCLAIMS ANY EXPRESS OR IMPLIED WARRANTY WITH RESPECT TO THE USE AND/OR SALE OF ST PRODUCTS INCLUDING WITHOUT LIMITATION IMPLIED WARRANTIES OF MERCHANTABILITY, FITNESS FOR A PARTICULAR PURPOSE (AND THEIR EQUIVALENTS UNDER THE LAWS OF ANY JURISDICTION), OR INFRINGEMENT OF ANY PATENT, COPYRIGHT OR OTHER INTELLECTUAL PROPERTY RIGHT.

UNLESS EXPRESSLY APPROVED IN WRITING BY AN AUTHORIZED ST REPRESENTATIVE, ST PRODUCTS ARE NOT RECOMMENDED, AUTHORIZED OR WARRANTED FOR USE IN MILITARY, AIR CRAFT, SPACE, LIFE SAVING, OR LIFE SUSTAINING APPLICATIONS, NOR IN PRODUCTS OR SYSTEMS WHERE FAILURE OR MALFUNCTION MAY RESULT IN PERSONAL INJURY, DEATH, OR SEVERE PROPERTY OR ENVIRONMENTAL DAMAGE. ST PRODUCTS WHICH ARE NOT SPECIFIED AS "AUTOMOTIVE GRADE" MAY ONLY BE USED IN AUTOMOTIVE APPLICATIONS AT USER'S OWN RISK.

Resale of ST products with provisions different from the statements and/or technical features set forth in this document shall immediately void any warranty granted by ST for the ST product or service described herein and shall not create or extend in any manner whatsoever, any liability of ST.

ST and the ST logo are trademarks or registered trademarks of ST in various countries.

Information in this document supersedes and replaces all information previously supplied.

The ST logo is a registered trademark of STMicroelectronics. All other names are the property of their respective owners.

© 2011 STMicroelectronics - All rights reserved

STMicroelectronics group of companies

Australia - Belgium - Brazil - Canada - China - Czech Republic - Finland - France - Germany - Hong Kong - India - Israel - Italy - Japan - Malaysia - Malta - Morocco - Philippines - Singapore - Spain - Sweden - Switzerland - United Kingdom - United States of America

www.st.com

Данный компонент на территории Российской Федерации

Вы можете приобрести в компании MosChip.

Для оперативного оформления запроса Вам необходимо перейти по данной ссылке:

<http://moschip.ru/get-element>

Вы можете разместить у нас заказ для любого Вашего проекта, будь то серийное производство или разработка единичного прибора.

В нашем ассортименте представлены ведущие мировые производители активных и пассивных электронных компонентов.

Нашей специализацией является поставка электронной компонентной базы двойного назначения, продукции таких производителей как XILINX, Intel (ex.ALTERA), Vicor, Microchip, Texas Instruments, Analog Devices, Mini-Circuits, Amphenol, Glenair.

Сотрудничество с глобальными дистрибьюторами электронных компонентов, предоставляет возможность заказывать и получать с международных складов практически любой перечень компонентов в оптимальные для Вас сроки.

На всех этапах разработки и производства наши партнеры могут получить квалифицированную поддержку опытных инженеров.

Система менеджмента качества компании отвечает требованиям в соответствии с ГОСТ Р ИСО 9001, ГОСТ РВ 0015-002 и ЭС РД 009

Офис по работе с юридическими лицами:

105318, г.Москва, ул.Щербаковская д.3, офис 1107, 1118, ДЦ «Щербаковский»

Телефон: +7 495 668-12-70 (многоканальный)

Факс: +7 495 668-12-70 (доб.304)

E-mail: info@moschip.ru

Skype отдела продаж:

moschip.ru

moschip.ru_4

moschip.ru_6

moschip.ru_9