

## ***bq24195/L EVM (PWR193) User's Guide***

### **Contents**

1	Introduction .....	2
	1.1 General Descriptions .....	2
2	Test Summary .....	3
	2.1 Equipment .....	3
	2.2 Equipment Setup .....	5
	2.3 Procedure .....	6

### **List of Figures**

1	Connections of the HPA172 Kit .....	5
2	Original Test Setup for PWR193 (bq24195/L EVM) .....	5
3	Main Window of the bq24195x Evaluation Software for bq24195/L .....	6
4	CHG Mode Ripple and Duty Cycle: $V_{BUS} = 5\text{ V}$ , $V_{BAT} = 3.7\text{ V}$ .....	8
5	Boost Mode Ripple and Duty Cycle; $V_{BAT} = 3.7\text{ V}$ .....	9
6	bq24195/L EVM Top Layer.....	11
7	bq24195/L EVM Second Layer .....	12
8	bq24195/L EVM Third Layer .....	13
9	bq24195/L EVM Bottom Layer.....	14
10	bq24195/L EVM Top Assembly.....	15
11	bq24195/L EVM Bottom Assembly.....	16
12	bq24195/L EVM Schematic .....	17

### **List of Tables**

1	EVM Connections.....	2
2	Jumper Connections.....	3
3	Recommended Operating Conditions .....	3
4	Device ID JEITA Settings .....	9
5	Bill of Materials.....	18

## 1 Introduction

### EVM Features

Refer to the data sheet ([SLUSB97](#)) for detailed features and operation.

### Design Considerations

This EVM has protection circuitry, external to the IC, to protect against applying a power source to the input (VBUS) when the IC is in boost mode, converting battery power to a 5-VDC PMID output. This is accomplished by two circuits on the EVM schematic by (1) adding an isolation circuit consisting of Q1, its drive Q3, to apply input power when available and disconnect it when not available and (2) by pulling OTG low, with Q2, when the input is available. Pulling OTG low disables the boost-mode operation.

The OTG pin should be pulled low at least a few microseconds before the input power is applied via Q1. This is accomplished on this EVM by setting the drive resistance for Q2 (OTG ckt.) lower and drive resistance for Q3 (VBUS connection) higher. The voltage threshold and resistance of the driver along with the input capacitance of Q2 and Q3 set the desired timing sequencing. Q3 (VBUS turn on) has a Thevenin-equivalent drive of 72k and for Q2 (OTG ckt.) is 35k, allowing the OTG signal to be pulled low (disables Boost Mode) prior to the input voltage being applied.

### 1.1 General Descriptions

The bq24195/L evaluation module is a complete charger module for evaluating an I<sup>2</sup>C Controlled single NVDC-1 charge using the bq2419x devices.

The bq24195/L EVM doesn't include the USB-to-GPIO interface board. To evaluate the bq24195/L EVM must order USB-to-GPIO interface board separately.

For details, see bq24195/L data sheet.

### I/O Description

[Table 1](#) contains the jumper connections for this EVM.

**Table 1. EVM Connections**

Jack	Description
J1-V <sub>IN</sub>	Input: positive terminal
J1-GND	Input: negative terminal (ground terminal)
J2-SYS	Connected to system
J2-BAT+	Connected to battery pack
J2-GND	Ground
J3	USB-to-GPIO connector (USB Interface Adapter Connector - HPA172)
J4-INT	INT pin connection
J4- OTG	OTG pin connection
J4-CE	CE pin connection
J4-GND	Ground
J5-PMID	PMID pin connection or power bank output
J5-GND	Ground
J6-TS2	External TS2 pin connection
J6-GND	Ground
J7	Mini_USB Connector
J5-TS2	External TS2 pin connection

Table 2 lists the controls and key parameter settings for this EVM.

**Table 2. Jumper Connections**

Jack	Description	Factory Setting
JP1	TS1 to TS2 connection	Shunt installed
JP2	D- 20k pull down	Shunt not installed
JP3	VSYS pull-up for STAT, $\overline{\text{CE}}$ , INT	Shunt installed
JP4	USB current limit selection pin during buck mode and PSEL is high (JP1-High); enable pin during boost mode. In buck mode: OTG = High, $I_{\text{IN}}$ limit = 500 mA; OTG = Low, $I_{\text{IN}}$ limit = 100 mA. The boost mode is activated when the REG01[5:4] = 10 and OTG pin is HIGH.	Shunt not installed
JP5	/CE pin setting: Pull low to enable the charge (GUI also can pull CE low)	Shunt not installed
JP6	200- $\Omega$ short between D+ and D-	Shunt not installed
JP7	TS2 resistor divider pull-up source (REGN) connection	Shunt installed
JP8	Internal 10k to ground to TS2	Shunt installed
JP9	D+ 20k Pull down	Shunt not installed

Table 3 lists the recommended operating conditions for this EVM.

**Table 3. Recommended Operating Conditions**

Symbol	Description	MIN	TYP	MAX	Unit
Supply voltage, $V_{\text{IN}}$	Input voltage from AC adapter input	3.9	5	6	V
Battery voltage, $V_{\text{BAT}}$	Voltage applied at $V_{\text{BAT}}$ terminal	0	3.7	4.25	V
Supply current, $I_{\text{AC}}$	Maximum input current from AC adapter input	0		3	A
Output current, $I_{\text{OUT}}$	Output current	0		4	A
Operating junction temperature range, $T_{\text{J}}$		0		125	$^{\circ}\text{C}$

## 2 Test Summary

Section 2.1 – Section 2.3 explain the equipment, the equipment setup, and the test procedures.

### 2.1 Equipment

#### Power Supplies

Power supply #1 (PS#1): a power supply capable of supplying 5 V at 1 A is required. While this part can handle larger voltage and current, it is not necessary for this procedure.

#### Load #1 (4-Quadrant Supply, Constant Voltage < 4.5 V)

A 0–20 V/0–5 A, > 30-W system, DC electronic load and setting as constant voltage load mode.

Or:

Kepeco load: BOP 20–5M, DC 0 to  $\pm 20$  V, 0 to  $\pm 5$  A (or higher)

Or:

Real single-cell battery

#### Load #2 – Use with Boost Mode

PMID-to-GND load, 10  $\Omega$ , 5 W or greater

#### Meters

Six Fluke 75 multimeters, (equivalent or better)

Or:

Four equivalent voltage meters and two equivalent current meters.

The current meters must be capable of measuring 5 A+ current.

**Computer**

A computer with at least one USB port and a USB cable. The bq2419xEVM evaluation software must be properly installed.

**USB-to-GPIO Communication Kit (HPA172-USB Interface Adapter)****Software**

Unzip the bq2419xEVM\_GUI.zip and double-click on the *SETUP.EXE* file. Follow the installation steps. The software supports the Windows® XP and Windows 7 operating systems.

## 2.2 Equipment Setup

1. Set PS#1 for 5-V DC, 1-A current limit and then turn off the supply.
2. Connect the output of PS#1 in series with a current meter (multimeter) to J1 (V<sub>BUS</sub> and GND).
3. Connect a voltage meter across J1 (V<sub>BUS</sub>) and J1 (GND).
4. Turn on the Load, set to constant voltage mode and output to 2.5 V. Turn off (disable) Load. Connect Load in series with a current meter (multimeter), ground side, to J2 (BAT+ and GND) as shown in Figure 2.
5. Connect a voltage meter across J2 (BAT+ and GND).
6. Connect the HPA172 USB interface adapter to the computer with a USB mini-cable and to J3 with the 10-pin ribbon cable. The connections are shown in Figure 1.

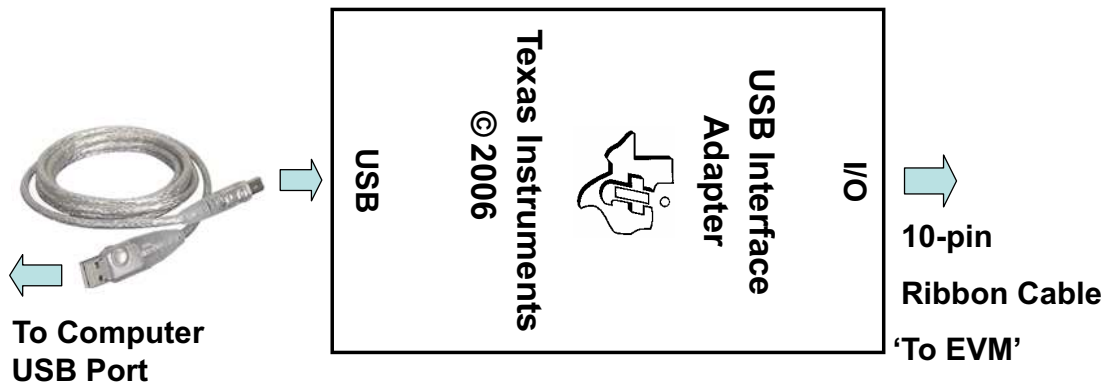

Figure 1. Connections of the HPA172 Kit

Figure 2 shows the test setup for PWR193.

7. Install shunts as shown in Table 2.

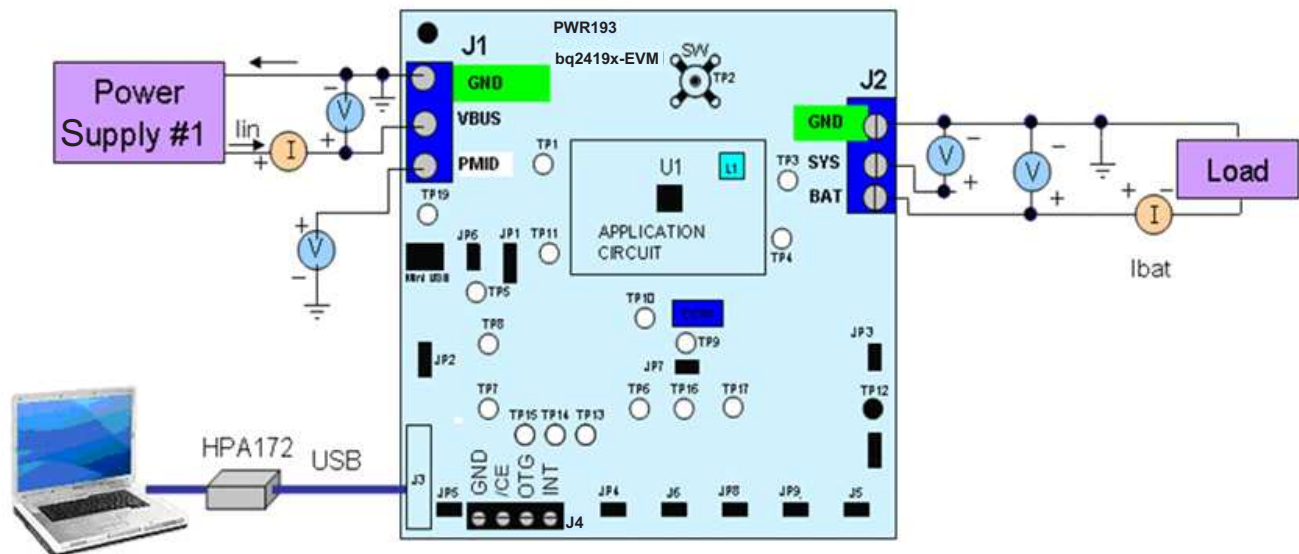

Figure 2. Original Test Setup for PWR193 (bq24195/L EVM)

- Turn on the computer. Launch the bq2419xEVM evaluation software. The main window of the software is shown in Figure 3.

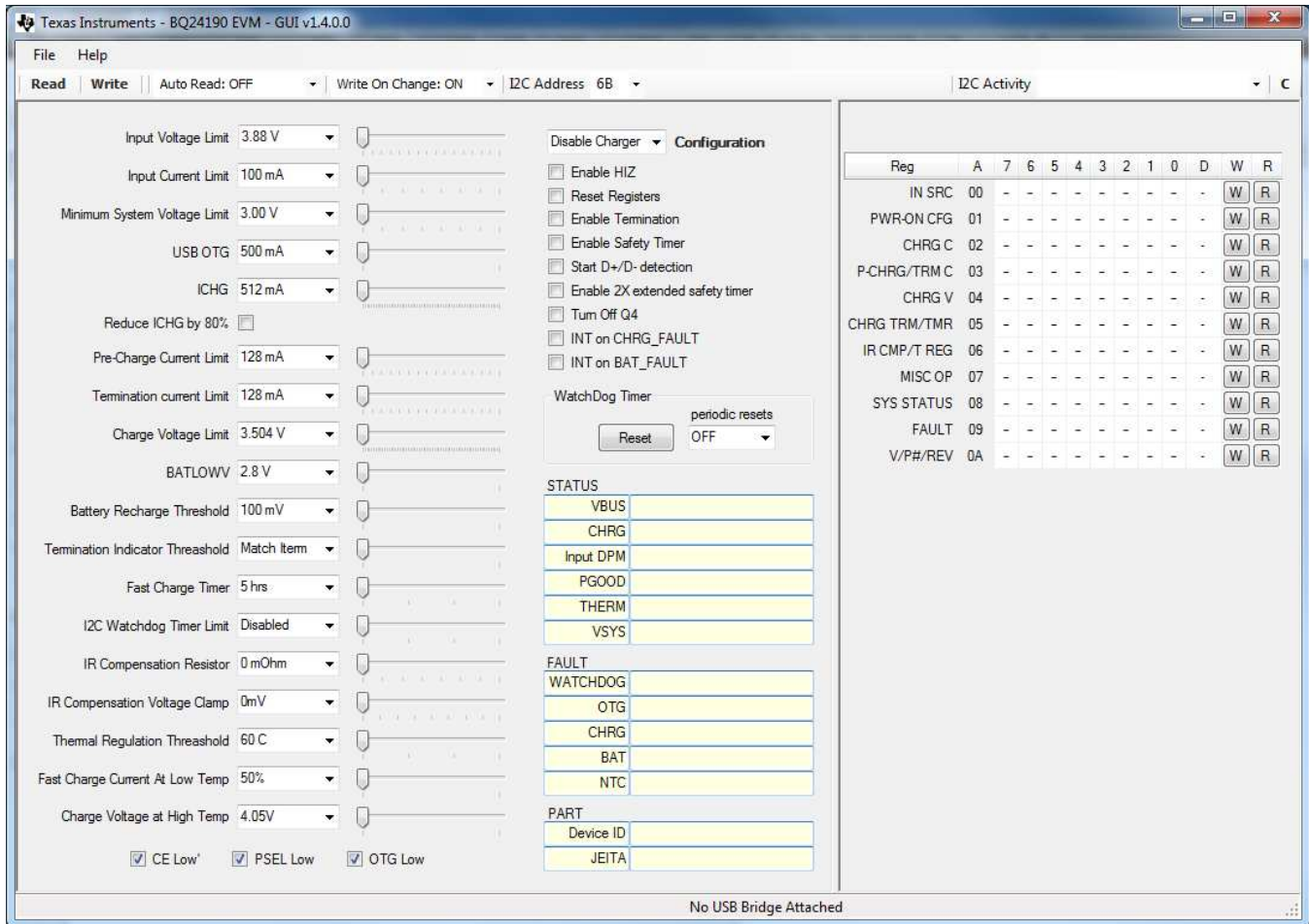

Figure 3. Main Window of the bq24195x Evaluation Software for bq24195/L

### 2.3 Procedure

Follow the steps and verify the outputs and IC for the EVM.

#### Current Settings

- Make Sure EQUIPMENT SETUP steps are followed.  
ILIM Setting: Set the potentiometer to its lowest value for max input current by connecting an ohm-meter between point TP9 and ground. Turn the screw on the potentiometer counterclockwise until the resistance drops to its lowest point (approximately 169  $\Omega$ , the value of R7)
- Launch the BQ2419x EVM GUI software, if not already done
- Turn on PS#1  
Measure  $\rightarrow V (J2(SYS), J2(GND)) = 4.10 \pm 300 \text{ mV}$

## Charge Voltage and Current Regulation of $V_{IN}$ and Device ID Verification

Follow the steps and verify the outputs and IC for the EVM.

### 2.3.0.1 Software setup (all of [Section 2.3.0.1](#) is done in the GUI):

1. Device address: bq24195/L (6B)



2. Click the **Read** button
3. Select *Disabled* for *PC Watchdog Timer Limit*
4. Set *Input Voltage Limit* to 4.2 V
5. Set *Input Current Limit* to 500 mA
6. Set *Charge Voltage Limit* to 4.208 V
7. Set *Fast Charge Current, ICHG* to 512 mA
8. Set *Pre-Charge Current* to 256 mA
9. Deselect *Enable Termination* (see the following image)

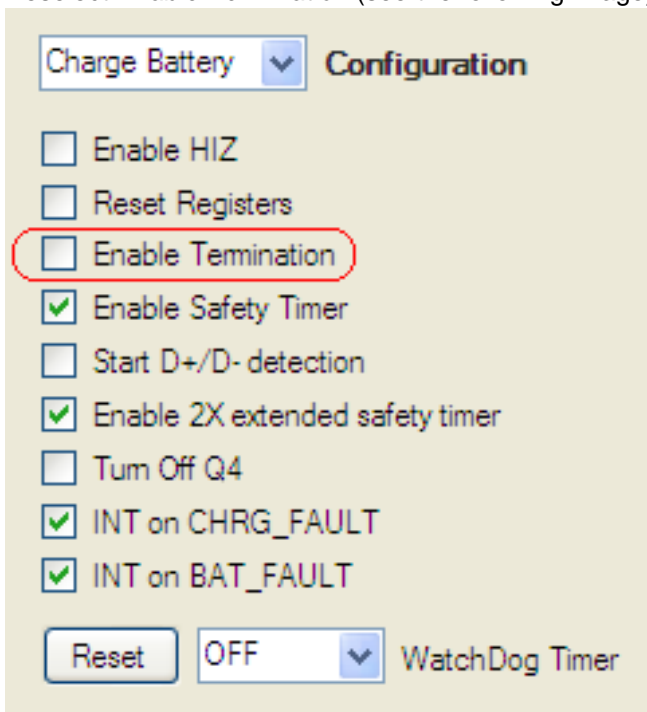

10. Click the **Read** button twice
  - Observe → Everything normal at *FAULT* box
  - Observe → D1 (STAT) is on, except the bq24192IEVM

### Enable Load#1 from [Section 2.2](#) step 4. Measure the voltage across J2 at two different points: $V(J2(SYS), J2(GND))$ and $V(J2(BAT), J2(GND))$

Measure →  $V(J2(SYS), J2(GND)) = 3.65 \text{ V} \pm 300 \text{ mV}$

Measure →  $V(J2(BAT), J2(GND)) = 2.5 \text{ V} \pm 200 \text{ mV}$

**Increase the Constant Voltage Load to 3.7 V<sub>DC</sub>**

Measure → V(J2(SYS), J2(GND)) = 3.75 V ±200 mV

Measure → I<sub>BAT</sub> = 500 mA ±200 mA

Measure → V(J2(BAT), J2(GND)) = 3.7 V ±200 mV

**In the software, set Fast Charge Current, I<sub>CHG</sub> to 1.012 A**

Measure → I<sub>IN</sub> = 500 mA ±200 mA

**Verify Scope Measurements (See Figure 4 – 500 ns/div)**

C1 (AC coupled 20 mV/div): Vac\_P MID (TP20 to GND) – Ripple excluding high frequency spikes < 10 mV

C2 (5 V/div): Vdc\_SW (TP2) - Frequency between 1.25 MHz and 1.5 MHz, duty cycle between 73% and 81%

C3 (AC coupled 20 mV/div): Vac\_VSYS (TP3 to GND) - excluding high frequency spikes < 15 mV

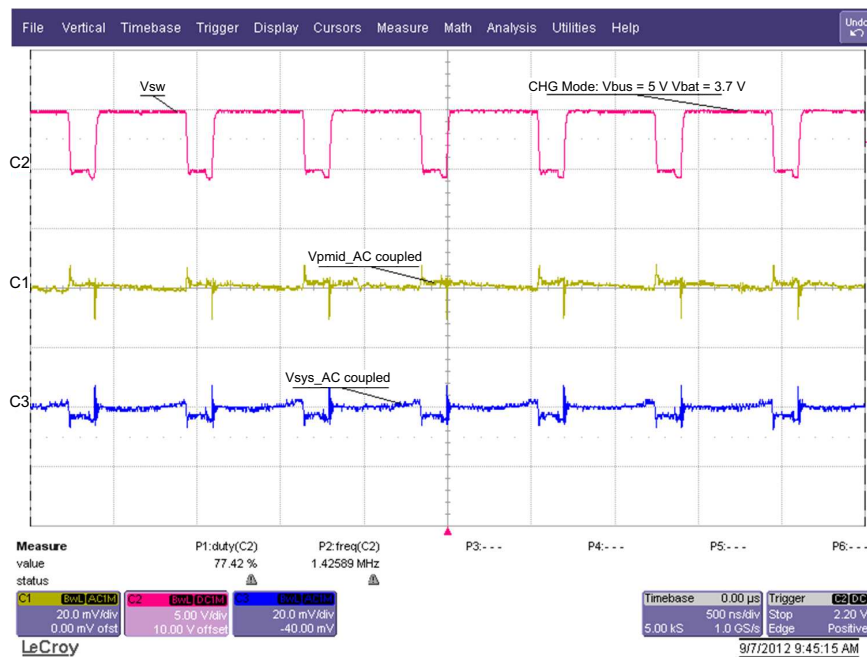

**Figure 4. CHG Mode Ripple and Duty Cycle: V<sub>BUS</sub> = 5 V, V<sub>BAT</sub> = 3.7 V**



**Switch to Boost Mode**

1. Turn off and disconnect PS#1
2. If the constant voltage load connected from BAT+ to GND is not a four-quadrant supply (sources current) remove the load and use the power source disconnected in step one, set to 3.7 V and 2 A current limit and connect between BAT+ and GND
3. Apply 10 Ω (5 W or greater) across J5 (PMID(+)) to GND(-)
4. Uncheck the *OTG Low* box in the GUI
5. Select OTG in the *Configuration* drop-down window
6. Verify  $V_{PMID}$  to GND on J5 is between 4.9 V and 5.3 V
7. Verify scope measurement (Figure 5)  
 C1 (AC coupled 20 mV/div):  $V_{ac\_PMID}$  (TP20 to GND) – Ripple excluding high-frequency spikes  
 C2 (5 V/div):  $V_{dc\_SW}$  (TP2) - Frequency between 1.2 MHz and 1.7 MHz, Duty cycle between 67% and 74%



**Figure 5. Boost Mode Ripple and Duty Cycle;  $V_{BAT} = 3.7$  V**

Verify Device ID JEITA shown in software matches [Table 4](#)

**Table 4. Device ID JEITA Settings**

Assembly Number	EVM Part Number	Device ID	JEITA
PWR193-001	bq24195LEVM-021	100	Disabled
PWR193-002	bq24195EVM-021	100	Disabled

## PCB Layout Guideline

Minimize the switching node rise and fall times for minimum switching loss. Proper layout of the components minimizing high-frequency current path loop is important to prevent electrical and magnetic field radiation and high frequency resonant problems. This PCB layout priority list must be followed in the order presented for proper layout:

1. Place the input capacitor as close as possible to the PMID and GND pin connections and use the shortest possible copper trace connection or GND plane.
2. Place the inductor input terminal as close to the SW pin as possible. Minimize the copper area of this trace to lower electrical and magnetic field radiation but make the trace wide enough to carry the charging current. Do not use multiple layers in parallel for this connection. Minimize parasitic capacitance from this area to any other trace or plane.
3. Put an output capacitor near to the inductor and the IC. Tie ground connections to the IC ground with a short copper trace connection or GND plane.
4. Route analog ground separately from power ground. Connect analog ground and connect power ground separately. Connect analog ground and power ground together using power pad as the single ground connection point or use a 0- $\Omega$  resistor to tie analog ground to power ground.
5. Use a single ground connection to tie the charger power ground to the charger analog ground just beneath the IC. Use ground copper pour but avoid power pins to reduce inductive and capacitive noise coupling.
6. Place decoupling capacitors next to the IC pins and make the trace connection as short as possible.
7. It is critical that the exposed power pad on the backside of the IC package be soldered to the PCB ground. Ensure that there are sufficient thermal vias directly under the IC, connecting to the ground plane on the other layers.
8. The via size and number should be enough for a given current path.

See the EVM design for the recommended component placement with trace and via locations. For the QFN information, refer to [SCBA017](#) and [SLUA271](#).

## Board Layout, Schematic, and Bill of Materials

### Board Layout

Figure 6 through Figure 11 illustrate the board layouts for this EVM.

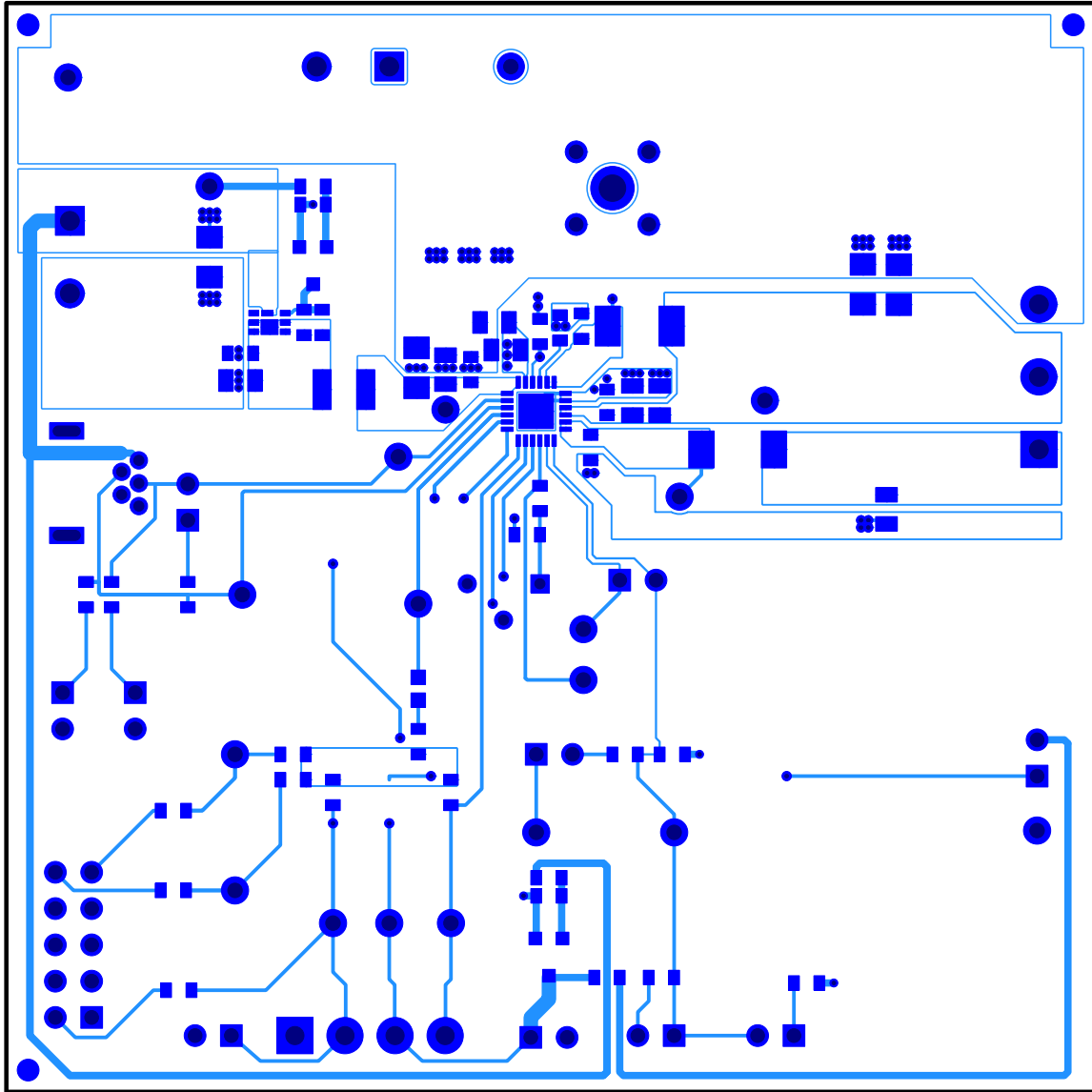

Figure 6. bq24195/L EVM Top Layer

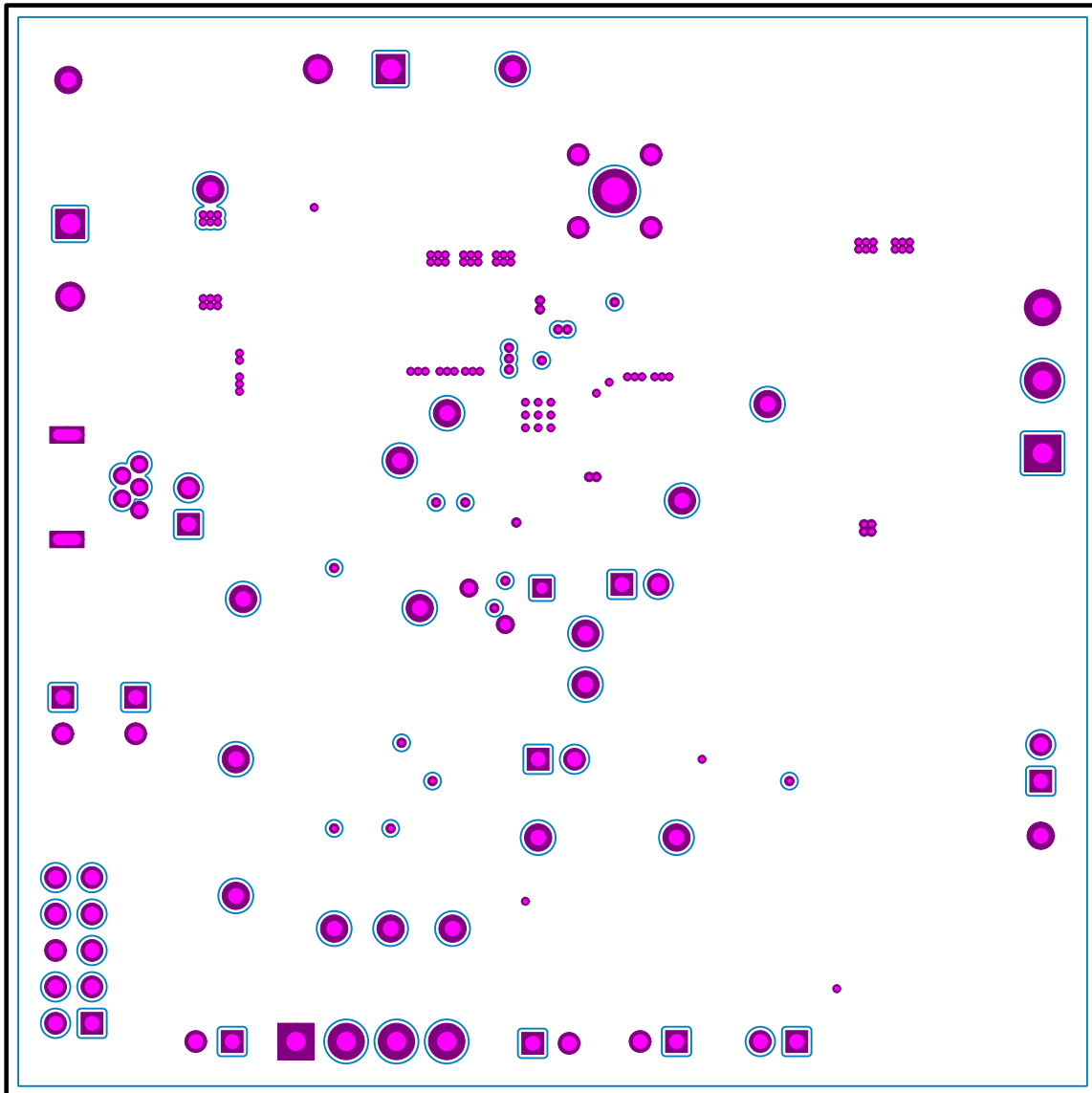

Figure 7. bq24195/L EVM Second Layer

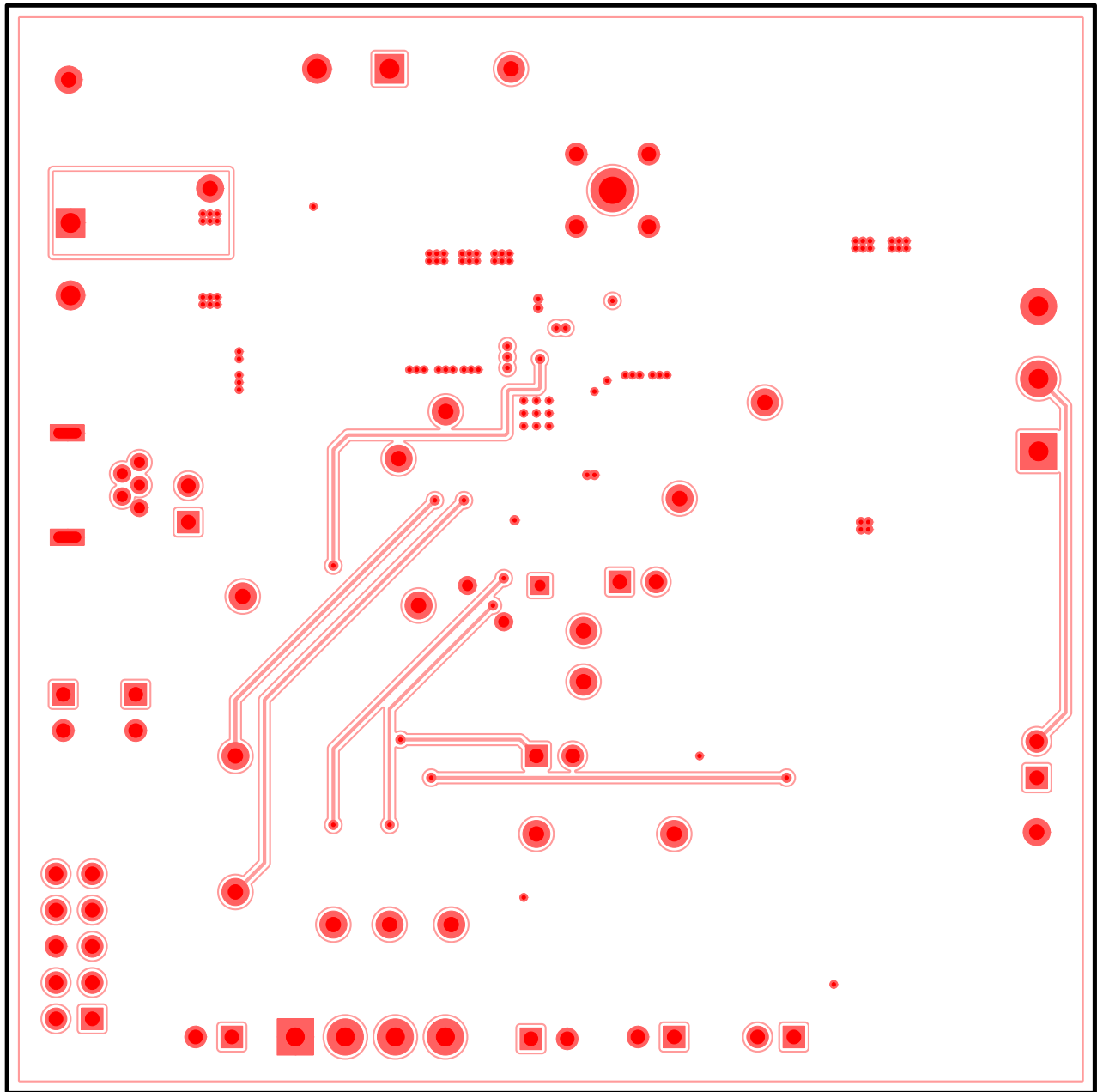

Figure 8. bq24195/L EVM Third Layer

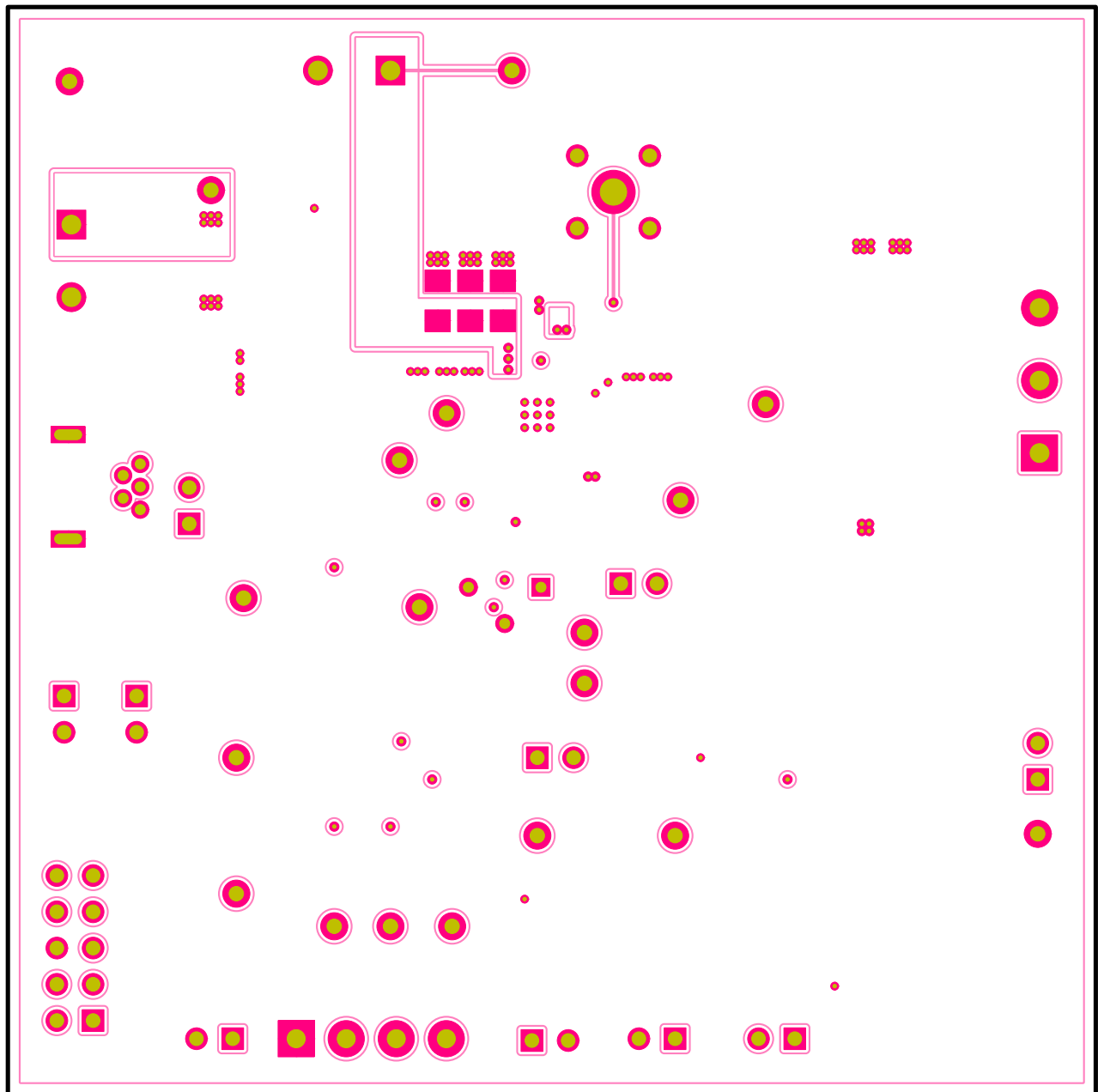
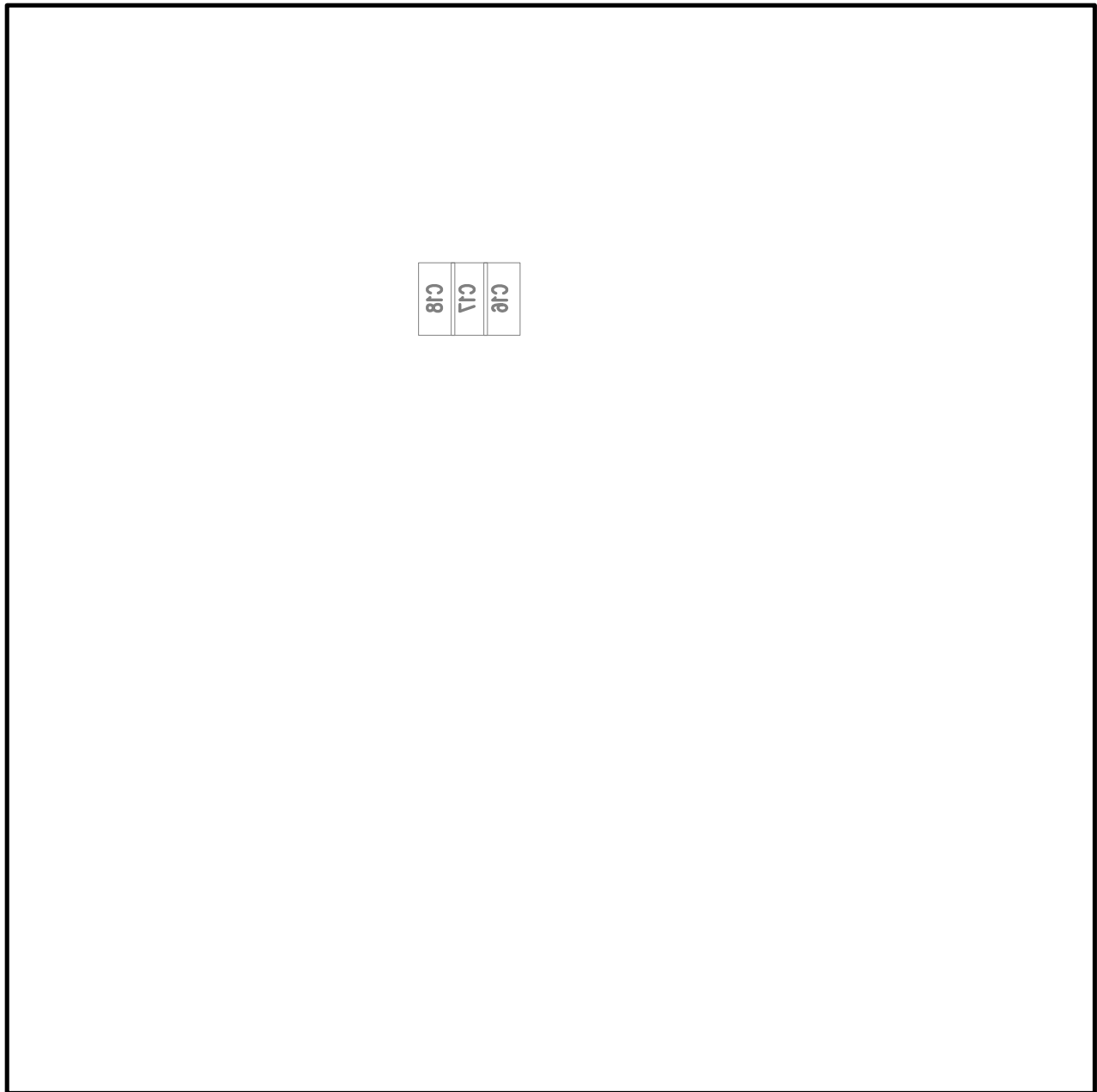

Figure 9. bq24195/L EVM Bottom Layer





**Figure 11. bq24195/L EVM Bottom Assembly**





Bill of Materials

Table 5 contains the bill of materials.

Table 5. Bill of Materials

-001	-002	RefDes	Value	Description	Size	Part Number	MFR
2	2	C1, C20	1.0 µF	Capacitor, ceramic, 25 V, X7R, 10%	1206	STD	STD
1	1	C10	1.0 µF	Capacitor, ceramic, 10 V, X7R, 10%	0805	STD	STD
1	1	C11	10 µF	Capacitor, ceramic, 10 V, X5R, 10%	0603	STD	STD
1	1	C14	Open	Capacitor, ceramic, 10 V X5R, 10%	0805	STD	STD
0	1	C16	10 µF	Capacitor, ceramic, 10 V, X5R, 10%	1206	STD	STD
0	2	C17, C18	22 µF	Capacitor, ceramic, 10 V, X5R, 20%	1206	STD	STD
3	3	C2, C21, C22	Open	Capacitor, ceramic	0603	STD	STD
2	2	C3, C12	Open	Capacitor, ceramic, 10 V X5R, 10%	1206	STD	STD
2	2	C4, C15	10 µF	Capacitor, ceramic, 25 V, X5R, 10%	0805	STD	STD
1	1	C5	47 nF	Capacitor, ceramic, 16 V, X7R, 10%	0603	STD	STD
1	1	C6	4.7 µF	Capacitor, ceramic, 16 V, X7R, 10%	0603	STD	STD
3	3	C7, C8, C19	10 µF	Capacitor, ceramic, 25 V X5R, 10%	0805	STD	STD
2	2	C9, C13	0.1 µF	Capacitor, ceramic, 25 V, X7R, 10%	0603	STD	STD
1	1	D1	LTST-C190GKT	Diode, LED, green, 2.1 V, 20 mA, 6 mcd	0603	LTST-C190GKT	Lite On
2	2	J1, J5	ED120/2DS	Connector, 15 A, 300 V male 2 pole, 5.08 mm	9 x 12 mm	ED120/2DS	On Shore Tech
1	1	J2	ED120/3DS	Terminal block, 3 pin, 15 A, 5.1mm	0.60 x 0.35 inch	ED120/3DS	OST
1	1	J3	N2510-6002RB	Connector, male straight 2 x 5 pin, 100 mil spacing, 4 wall	0.338 x 0.788 in	N2510-6002RB	3M
1	1	J4	ED555/4DS	Terminal block, 4 pin, 6 A, 3.5 mm	0.55 x 0.25 in	ED555/4DS	OST
1	1	J6	PEC02SAAN	Header, Male 2 pin, 100 mil spacing,	0.100 in x 2	PEC02SAAN	Sullins
1	1	J7	A-USB B-M5	Connector, USB-B, mini, 5 pins	0.354 x 0.307 in	A-USB B-M5	
9	9	JP1, JP2, JP3, JP4, JP5, JP6, JP7, JP8, JP9	PEC02SAAN	Header, Male 2 pin, 100mil spacing,	0.100 in x 2	PEC02SAAN	Sullins
1	1	L1	2.2 µH	Inductor, SMT, 5 A, 37 mΩ	0.204 x 0.216 in	IHLP2020BZER2R2M11	Vishay
1	1	Q1	CSD25302Q2	Trans, P-Channel NexFET, 20 V, 5 A, 56 mΩ	SON 2 x 2	CSD25302Q2	TI
2	2	Q2, Q3	Si2312DS	MOSFET, N-Channel, 20 V, 4.9 A, 33 mΩ	SOT23	Si2312DS	Vishay
1	1	R1	0 Ω	Resistor, chip, 1/16W,	0603	STD	STD
1	1	R14	2.21 kΩ	Resistor, chip, 1/16W, 1%	0603	STD	STD
1	1	R15	10.0 kΩ	Potentiometer, 3/8 cermet, single-turn	0.25 x 0.17 in	3266W-1-103LF	Bourns
1	1	R18	261 kΩ	Resistor, chip, 1/16W, 1%	0603	STD	STD
1	1	R19	121 kΩ	Resistor, chip, 1/16W, 1%	0603	STD	STD
1	1	R2	0 Ω	Resistor, chip, 0.6W, 1%	2010	STD	STD
1	1	R21	30.1 kΩ	Resistor, chip, 1/16W, 1%	0603	STD	STD
1	1	R22	5.23 kΩ	Resistor, chip, 1/16W, 1%	0603	STD	STD
1	1	R24	768 Ω	Resistor, chip, 1/16W, 1%	0603	STD	STD
1	1	R25	49.9 kΩ	Resistor, chip, 1/16W, 1%	0603	STD	STD
1	1	R3	0 Ω	Resistor, chip, 1/2W, yy%	1210	STD	STD
4	4	R4, R12, R13, R27	200 Ω	Resistor, chip, 1/16W, 1%	0603	STD	STD
1	1	R5	100 kΩ	Resistor, chip, 1/16W, 1%	0603	STD	STD
2	2	R6, R23	Open	Resistor, chip, 1/16W	0603	STD	STD
1	1	R7	169 Ω	Resistor, chip, 1/16W, 1%	0603	STD	STD
5	5	R8, R11, R16, R17, R20	10.0 kΩ	Resistor, chip, 1/16W, 1%	0603	STD	STD
2	2	R9, R26	20 kΩ	Resistor, chip, 1/16W, 1%	0603	STD	STD
17	17	TP1, TP3, TP4, TP5, TP6, TP7, TP8, TP9, TP10, TP11, TP13, TP14, TP15, TP16, TP17, TP19, TP20	5002	Test point, white, thru hole color keyed	0.100 x 0.100 in	5002	Keystone
2	2	TP12, TP18	5001	Test point, black, thru hole color keyed	0.100 x 0.100 in	5001	Keystone
1	1	TP2	131-4244-00	Adaptor, 3.5-mm probe clip ( or 131-5031-00)	0.200 in	131-4244-00	Tektronix

**Table 5. Bill of Materials (continued)**

-001	-002	RefDes	Value	Description	Size	Part Number	MFR
1	0	U1	BQ24195LRGE	IC, I2C Controlled 2.5A Single Cell USB / Adaptor Charger With Narrow VDC Power Path Management and USB OTG	QFN-23	BQ24195LRGE	TI
0	1	U1	BQ24195RGE	IC, I <sup>2</sup> C controlled 2.5-A single cell USB/adaptor charger with narrow VDC power-path management and USB OTG	QFN-24	BQ24195RGE	TI
1	1	--		PCB	3 in x 3 in x 0.031 in	PWR193	Any
1	1	--		Label (See note 5)	1.25 x 0.25 in	THT-13-457-10	Brady
4	4	-	SJ-5303	Rubber foot (see note 6)	0.044 x 0.20 in	SJ-5303	3M
Notes:		1. These assemblies are ESD sensitive, observe ESD precautions.					
		2. These assemblies must be clean and free from flux and all contaminants. Use of no-clean flux is not acceptable.					
		3. These assemblies must comply with workmanship standards IPC-A-610 Class 2.					
		4. Ref designators marked with an asterisk (***) cannot be substituted. All other components can be substituted with equivalent MFG's components.					
		5. Install label after final wash. Text shall be 8 pt font. Text shall be per <b>Label Information</b> .					
		6. Install after final wash.					
		<b>Label Information</b>					
		Assembly number	Text				
		PWR193-001	bq24195LEVM-021				
		PWR193-002	bq24195EVM-021				

---

## Revision History

Changes from Original (October 2012) to A Revision	Page
• Deleted 12 (V) from TYP column of Supply voltage, $V_{IN}$ in Recommended Operating Conditions table. ....	3

---

NOTE: Page numbers for previous revisions may differ from page numbers in the current version.

## EVALUATION BOARD/KIT/MODULE (EVM) ADDITIONAL TERMS

Texas Instruments (TI) provides the enclosed Evaluation Board/Kit/Module (EVM) under the following conditions:

The user assumes all responsibility and liability for proper and safe handling of the goods. Further, the user indemnifies TI from all claims arising from the handling or use of the goods.

Should this evaluation board/kit not meet the specifications indicated in the User's Guide, the board/kit may be returned within 30 days from the date of delivery for a full refund. THE FOREGOING LIMITED WARRANTY IS THE EXCLUSIVE WARRANTY MADE BY SELLER TO BUYER AND IS IN LIEU OF ALL OTHER WARRANTIES, EXPRESSED, IMPLIED, OR STATUTORY, INCLUDING ANY WARRANTY OF MERCHANTABILITY OR FITNESS FOR ANY PARTICULAR PURPOSE. EXCEPT TO THE EXTENT OF THE INDEMNITY SET FORTH ABOVE, NEITHER PARTY SHALL BE LIABLE TO THE OTHER FOR ANY INDIRECT, SPECIAL, INCIDENTAL, OR CONSEQUENTIAL DAMAGES.

Please read the User's Guide and, specifically, the Warnings and Restrictions notice in the User's Guide prior to handling the product. This notice contains important safety information about temperatures and voltages. For additional information on TI's environmental and/or safety programs, please visit [www.ti.com/esh](http://www.ti.com/esh) or contact TI.

No license is granted under any patent right or other intellectual property right of TI covering or relating to any machine, process, or combination in which such TI products or services might be or are used. TI currently deals with a variety of customers for products, and therefore our arrangement with the user is not exclusive. TI assumes no liability for applications assistance, customer product design, software performance, or infringement of patents or services described herein.

## REGULATORY COMPLIANCE INFORMATION

As noted in the EVM User's Guide and/or EVM itself, this EVM and/or accompanying hardware may or may not be subject to the Federal Communications Commission (FCC) and Industry Canada (IC) rules.

For EVMs **not** subject to the above rules, this evaluation board/kit/module is intended for use for ENGINEERING DEVELOPMENT, DEMONSTRATION OR EVALUATION PURPOSES ONLY and is not considered by TI to be a finished end product fit for general consumer use. It generates, uses, and can radiate radio frequency energy and has not been tested for compliance with the limits of computing devices pursuant to part 15 of FCC or ICES-003 rules, which are designed to provide reasonable protection against radio frequency interference. Operation of the equipment may cause interference with radio communications, in which case the user at his own expense will be required to take whatever measures may be required to correct this interference.

### General Statement for EVMs including a radio

*User Power/Frequency Use Obligations:* This radio is intended for development/professional use only in legally allocated frequency and power limits. Any use of radio frequencies and/or power availability of this EVM and its development application(s) must comply with local laws governing radio spectrum allocation and power limits for this evaluation module. It is the user's sole responsibility to only operate this radio in legally acceptable frequency space and within legally mandated power limitations. Any exceptions to this are strictly prohibited and unauthorized by Texas Instruments unless user has obtained appropriate experimental/development licenses from local regulatory authorities, which is responsibility of user including its acceptable authorization.

### For EVMs annotated as FCC – FEDERAL COMMUNICATIONS COMMISSION Part 15 Compliant

#### Caution

This device complies with part 15 of the FCC Rules. Operation is subject to the following two conditions: (1) This device may not cause harmful interference, and (2) this device must accept any interference received, including interference that may cause undesired operation.

Changes or modifications not expressly approved by the party responsible for compliance could void the user's authority to operate the equipment.

### FCC Interference Statement for Class A EVM devices

This equipment has been tested and found to comply with the limits for a Class A digital device, pursuant to part 15 of the FCC Rules. These limits are designed to provide reasonable protection against harmful interference when the equipment is operated in a commercial environment. This equipment generates, uses, and can radiate radio frequency energy and, if not installed and used in accordance with the instruction manual, may cause harmful interference to radio communications. Operation of this equipment in a residential area is likely to cause harmful interference in which case the user will be required to correct the interference at his own expense.

### **FCC Interference Statement for Class B EVM devices**

This equipment has been tested and found to comply with the limits for a Class B digital device, pursuant to part 15 of the FCC Rules. These limits are designed to provide reasonable protection against harmful interference in a residential installation. This equipment generates, uses and can radiate radio frequency energy and, if not installed and used in accordance with the instructions, may cause harmful interference to radio communications. However, there is no guarantee that interference will not occur in a particular installation. If this equipment does cause harmful interference to radio or television reception, which can be determined by turning the equipment off and on, the user is encouraged to try to correct the interference by one or more of the following measures:

- Reorient or relocate the receiving antenna.
- Increase the separation between the equipment and receiver.
- Connect the equipment into an outlet on a circuit different from that to which the receiver is connected.
- Consult the dealer or an experienced radio/TV technician for help.

### **For EVMs annotated as IC – INDUSTRY CANADA Compliant**

This Class A or B digital apparatus complies with Canadian ICES-003.

Changes or modifications not expressly approved by the party responsible for compliance could void the user's authority to operate the equipment.

### **Concerning EVMs including radio transmitters**

This device complies with Industry Canada licence-exempt RSS standard(s). Operation is subject to the following two conditions: (1) this device may not cause interference, and (2) this device must accept any interference, including interference that may cause undesired operation of the device.

### **Concerning EVMs including detachable antennas**

Under Industry Canada regulations, this radio transmitter may only operate using an antenna of a type and maximum (or lesser) gain approved for the transmitter by Industry Canada. To reduce potential radio interference to other users, the antenna type and its gain should be so chosen that the equivalent isotropically radiated power (e.i.r.p.) is not more than that necessary for successful communication.

This radio transmitter has been approved by Industry Canada to operate with the antenna types listed in the user guide with the maximum permissible gain and required antenna impedance for each antenna type indicated. Antenna types not included in this list, having a gain greater than the maximum gain indicated for that type, are strictly prohibited for use with this device.

Cet appareil numérique de la classe A ou B est conforme à la norme NMB-003 du Canada.

Les changements ou les modifications pas expressément approuvés par la partie responsable de la conformité ont pu vider l'autorité de l'utilisateur pour actionner l'équipement.

### **Concernant les EVMs avec appareils radio**

Le présent appareil est conforme aux CNR d'Industrie Canada applicables aux appareils radio exempts de licence. L'exploitation est autorisée aux deux conditions suivantes : (1) l'appareil ne doit pas produire de brouillage, et (2) l'utilisateur de l'appareil doit accepter tout brouillage radioélectrique subi, même si le brouillage est susceptible d'en compromettre le fonctionnement.

### **Concernant les EVMs avec antennes détachables**

Conformément à la réglementation d'Industrie Canada, le présent émetteur radio peut fonctionner avec une antenne d'un type et d'un gain maximal (ou inférieur) approuvé pour l'émetteur par Industrie Canada. Dans le but de réduire les risques de brouillage radioélectrique à l'intention des autres utilisateurs, il faut choisir le type d'antenne et son gain de sorte que la puissance isotrope rayonnée équivalente (p.i.r.e.) ne dépasse pas l'intensité nécessaire à l'établissement d'une communication satisfaisante.

Le présent émetteur radio a été approuvé par Industrie Canada pour fonctionner avec les types d'antenne énumérés dans le manuel d'usage et ayant un gain admissible maximal et l'impédance requise pour chaque type d'antenne. Les types d'antenne non inclus dans cette liste, ou dont le gain est supérieur au gain maximal indiqué, sont strictement interdits pour l'exploitation de l'émetteur.

## **【Important Notice for Users of EVMs for RF Products in Japan】**

**This development kit is NOT certified as Confirming to Technical Regulations of Radio Law of Japan**

If you use this product in Japan, you are required by Radio Law of Japan to follow the instructions below with respect to this product:

1. Use this product in a shielded room or any other test facility as defined in the notification #173 issued by Ministry of Internal Affairs and Communications on March 28, 2006, based on Sub-section 1.1 of Article 6 of the Ministry's Rule for Enforcement of Radio Law of Japan,
2. Use this product only after you obtained the license of Test Radio Station as provided in Radio Law of Japan with respect to this product, or
3. Use of this product only after you obtained the Technical Regulations Conformity Certification as provided in Radio Law of Japan with respect to this product. Also, please do not transfer this product, unless you give the same notice above to the transferee. Please note that if you could not follow the instructions above, you will be subject to penalties of Radio Law of Japan.

**Texas Instruments Japan Limited**  
**(address) 24-1, Nishi-Shinjuku 6 chome, Shinjuku-ku, Tokyo, Japan**

<http://www.tij.co.jp>

### **【無線電波を送信する製品の開発キットをお使いになる際の注意事項】**

本開発キットは技術基準適合証明を受けておりません。

本製品のご使用に際しては、電波法遵守のため、以下のいずれかの措置を取っていただく必要がありますのでご注意ください。

1. 電波法施行規則第6条第1項第1号に基づく平成18年3月28日総務省告示第173号で定められた電波暗室等の試験設備でご使用いただく。
2. 実験局の免許を取得後ご使用いただく。
3. 技術基準適合証明を取得後ご使用いただく。

なお、本製品は、上記の「ご使用にあたっての注意」を譲渡先、移転先に通知しない限り、譲渡、移転できないものとします。

上記を遵守頂けない場合は、電波法の罰則が適用される可能性があることをご留意ください。

日本テキサス・インスツルメンツ株式会社

東京都新宿区西新宿 6 丁目 2 4 番 1 号

西新宿三井ビル

<http://www.tij.co.jp>

## **EVALUATION BOARD/KIT/MODULE (EVM) WARNINGS, RESTRICTIONS AND DISCLAIMERS**

**For Feasibility Evaluation Only, in Laboratory/Development Environments.** Unless otherwise indicated, this EVM is not a finished electrical equipment and not intended for consumer use. It is intended solely for use for preliminary feasibility evaluation in laboratory/development environments by technically qualified electronics experts who are familiar with the dangers and application risks associated with handling electrical mechanical components, systems and subsystems. It should not be used as all or part of a finished end product.

Your Sole Responsibility and Risk. You acknowledge, represent and agree that:

1. You have unique knowledge concerning Federal, State and local regulatory requirements (including but not limited to Food and Drug Administration regulations, if applicable) which relate to your products and which relate to your use (and/or that of your employees, affiliates, contractors or designees) of the EVM for evaluation, testing and other purposes.
2. You have full and exclusive responsibility to assure the safety and compliance of your products with all such laws and other applicable regulatory requirements, and also to assure the safety of any activities to be conducted by you and/or your employees, affiliates, contractors or designees, using the EVM. Further, you are responsible to assure that any interfaces (electronic and/or mechanical) between the EVM and any human body are designed with suitable isolation and means to safely limit accessible leakage currents to minimize the risk of electrical shock hazard.
3. Since the EVM is not a completed product, it may not meet all applicable regulatory and safety compliance standards (such as UL, CSA, VDE, CE, RoHS and WEEE) which may normally be associated with similar items. You assume full responsibility to determine and/or assure compliance with any such standards and related certifications as may be applicable. You will employ reasonable safeguards to ensure that your use of the EVM will not result in any property damage, injury or death, even if the EVM should fail to perform as described or expected.
4. You will take care of proper disposal and recycling of the EVM's electronic components and packing materials.

**Certain Instructions.** It is important to operate this EVM within TI's recommended specifications and environmental considerations per the user guidelines. Exceeding the specified EVM ratings (including but not limited to input and output voltage, current, power, and environmental ranges) may cause property damage, personal injury or death. If there are questions concerning these ratings please contact a TI field representative prior to connecting interface electronics including input power and intended loads. Any loads applied outside of the specified output range may result in unintended and/or inaccurate operation and/or possible permanent damage to the EVM and/or interface electronics. Please consult the EVM User's Guide prior to connecting any load to the EVM output. If there is uncertainty as to the load specification, please contact a TI field representative. During normal operation, some circuit components may have case temperatures greater than 60°C as long as the input and output are maintained at a normal ambient operating temperature. These components include but are not limited to linear regulators, switching transistors, pass transistors, and current sense resistors which can be identified using the EVM schematic located in the EVM User's Guide. When placing measurement probes near these devices during normal operation, please be aware that these devices may be very warm to the touch. As with all electronic evaluation tools, only qualified personnel knowledgeable in electronic measurement and diagnostics normally found in development environments should use these EVMs.

**Agreement to Defend, Indemnify and Hold Harmless.** You agree to defend, indemnify and hold TI, its licensors and their representatives harmless from and against any and all claims, damages, losses, expenses, costs and liabilities (collectively, "Claims") arising out of or in connection with any use of the EVM that is not in accordance with the terms of the agreement. This obligation shall apply whether Claims arise under law of tort or contract or any other legal theory, and even if the EVM fails to perform as described or expected.

**Safety-Critical or Life-Critical Applications.** If you intend to evaluate the components for possible use in safety critical applications (such as life support) where a failure of the TI product would reasonably be expected to cause severe personal injury or death, such as devices which are classified as FDA Class III or similar classification, then you must specifically notify TI of such intent and enter into a separate Assurance and Indemnity Agreement.

Mailing Address: Texas Instruments, Post Office Box 655303, Dallas, Texas 75265  
Copyright © 2014, Texas Instruments Incorporated



## IMPORTANT NOTICE

Texas Instruments Incorporated and its subsidiaries (TI) reserve the right to make corrections, enhancements, improvements and other changes to its semiconductor products and services per JESD46, latest issue, and to discontinue any product or service per JESD48, latest issue. Buyers should obtain the latest relevant information before placing orders and should verify that such information is current and complete. All semiconductor products (also referred to herein as "components") are sold subject to TI's terms and conditions of sale supplied at the time of order acknowledgment.

TI warrants performance of its components to the specifications applicable at the time of sale, in accordance with the warranty in TI's terms and conditions of sale of semiconductor products. Testing and other quality control techniques are used to the extent TI deems necessary to support this warranty. Except where mandated by applicable law, testing of all parameters of each component is not necessarily performed.

TI assumes no liability for applications assistance or the design of Buyers' products. Buyers are responsible for their products and applications using TI components. To minimize the risks associated with Buyers' products and applications, Buyers should provide adequate design and operating safeguards.

TI does not warrant or represent that any license, either express or implied, is granted under any patent right, copyright, mask work right, or other intellectual property right relating to any combination, machine, or process in which TI components or services are used. Information published by TI regarding third-party products or services does not constitute a license to use such products or services or a warranty or endorsement thereof. Use of such information may require a license from a third party under the patents or other intellectual property of the third party, or a license from TI under the patents or other intellectual property of TI.

Reproduction of significant portions of TI information in TI data books or data sheets is permissible only if reproduction is without alteration and is accompanied by all associated warranties, conditions, limitations, and notices. TI is not responsible or liable for such altered documentation. Information of third parties may be subject to additional restrictions.

Resale of TI components or services with statements different from or beyond the parameters stated by TI for that component or service voids all express and any implied warranties for the associated TI component or service and is an unfair and deceptive business practice. TI is not responsible or liable for any such statements.

Buyer acknowledges and agrees that it is solely responsible for compliance with all legal, regulatory and safety-related requirements concerning its products, and any use of TI components in its applications, notwithstanding any applications-related information or support that may be provided by TI. Buyer represents and agrees that it has all the necessary expertise to create and implement safeguards which anticipate dangerous consequences of failures, monitor failures and their consequences, lessen the likelihood of failures that might cause harm and take appropriate remedial actions. Buyer will fully indemnify TI and its representatives against any damages arising out of the use of any TI components in safety-critical applications.

In some cases, TI components may be promoted specifically to facilitate safety-related applications. With such components, TI's goal is to help enable customers to design and create their own end-product solutions that meet applicable functional safety standards and requirements. Nonetheless, such components are subject to these terms.

No TI components are authorized for use in FDA Class III (or similar life-critical medical equipment) unless authorized officers of the parties have executed a special agreement specifically governing such use.

Only those TI components which TI has specifically designated as military grade or "enhanced plastic" are designed and intended for use in military/aerospace applications or environments. Buyer acknowledges and agrees that any military or aerospace use of TI components which have **not** been so designated is solely at the Buyer's risk, and that Buyer is solely responsible for compliance with all legal and regulatory requirements in connection with such use.

TI has specifically designated certain components as meeting ISO/TS16949 requirements, mainly for automotive use. In any case of use of non-designated products, TI will not be responsible for any failure to meet ISO/TS16949.

### Products

Audio	<a href="http://www.ti.com/audio">www.ti.com/audio</a>
Amplifiers	<a href="http://amplifier.ti.com">amplifier.ti.com</a>
Data Converters	<a href="http://dataconverter.ti.com">dataconverter.ti.com</a>
DLP® Products	<a href="http://www.dlp.com">www.dlp.com</a>
DSP	<a href="http://dsp.ti.com">dsp.ti.com</a>
Clocks and Timers	<a href="http://www.ti.com/clocks">www.ti.com/clocks</a>
Interface	<a href="http://interface.ti.com">interface.ti.com</a>
Logic	<a href="http://logic.ti.com">logic.ti.com</a>
Power Mgmt	<a href="http://power.ti.com">power.ti.com</a>
Microcontrollers	<a href="http://microcontroller.ti.com">microcontroller.ti.com</a>
RFID	<a href="http://www.ti-rfid.com">www.ti-rfid.com</a>
OMAP Applications Processors	<a href="http://www.ti.com/omap">www.ti.com/omap</a>
Wireless Connectivity	<a href="http://www.ti.com/wirelessconnectivity">www.ti.com/wirelessconnectivity</a>

### Applications

Automotive and Transportation	<a href="http://www.ti.com/automotive">www.ti.com/automotive</a>
Communications and Telecom	<a href="http://www.ti.com/communications">www.ti.com/communications</a>
Computers and Peripherals	<a href="http://www.ti.com/computers">www.ti.com/computers</a>
Consumer Electronics	<a href="http://www.ti.com/consumer-apps">www.ti.com/consumer-apps</a>
Energy and Lighting	<a href="http://www.ti.com/energy">www.ti.com/energy</a>
Industrial	<a href="http://www.ti.com/industrial">www.ti.com/industrial</a>
Medical	<a href="http://www.ti.com/medical">www.ti.com/medical</a>
Security	<a href="http://www.ti.com/security">www.ti.com/security</a>
Space, Avionics and Defense	<a href="http://www.ti.com/space-avionics-defense">www.ti.com/space-avionics-defense</a>
Video and Imaging	<a href="http://www.ti.com/video">www.ti.com/video</a>

### TI E2E Community

[e2e.ti.com](http://e2e.ti.com)

## Данный компонент на территории Российской Федерации

### Вы можете приобрести в компании MosChip.

Для оперативного оформления запроса Вам необходимо перейти по данной ссылке:

<http://moschip.ru/get-element>

Вы можете разместить у нас заказ для любого Вашего проекта, будь то серийное производство или разработка единичного прибора.

В нашем ассортименте представлены ведущие мировые производители активных и пассивных электронных компонентов.

Нашей специализацией является поставка электронной компонентной базы двойного назначения, продукции таких производителей как XILINX, Intel (ex.ALTERA), Vicor, Microchip, Texas Instruments, Analog Devices, Mini-Circuits, Amphenol, Glenair.

Сотрудничество с глобальными дистрибьюторами электронных компонентов, предоставляет возможность заказывать и получать с международных складов практически любой перечень компонентов в оптимальные для Вас сроки.

На всех этапах разработки и производства наши партнеры могут получить квалифицированную поддержку опытных инженеров.

Система менеджмента качества компании отвечает требованиям в соответствии с ГОСТ Р ИСО 9001, ГОСТ РВ 0015-002 и ЭС РД 009

### Офис по работе с юридическими лицами:

105318, г.Москва, ул.Щербаковская д.3, офис 1107, 1118, ДЦ «Щербаковский»

Телефон: +7 495 668-12-70 (многоканальный)

Факс: +7 495 668-12-70 (доб.304)

E-mail: [info@moschip.ru](mailto:info@moschip.ru)

Skype отдела продаж:

moschip.ru

moschip.ru\_4

moschip.ru\_6

moschip.ru\_9