

Optocoupler, Photodarlington Output, High Gain, Single/Quad Channel, Half Pitch Mini-Flat Package

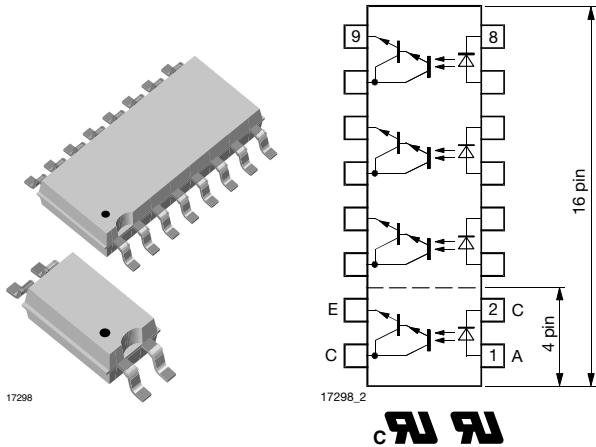

FEATURES

- Low profile package (half pitch)
- AC isolation test voltage 3750 V_{RMS}
- Low coupling capacitance of typical 0.3 pF
- Low temperature coefficient of CTR
- Wide ambient temperature range
- Material categorization:
For definitions of compliance please see www.vishay.com/doc?99912



APPLICATIONS

- Programmable logic
- Modems
- Answering machines
- General applications

AGENCY APPROVALS

- UL1577, file no. E76222 system code M, double protection
- CSA 22.2 bulletin 5A, double protection
- DIN EN 60747-5-5 (VDE 0884-5)
- FIMKO
- BSI

DESCRIPTION

The TCMD1000, TCMD4000 consist of a photodarlington optically coupled to a gallium arsenide infrared-emitting diodes in either a 4 pin or 16 pin miniflat package.

The elements provide a fixed distance between input and output for highest safety requirements.

ORDERING INFORMATION	
<div style="display: flex; justify-content: space-around; align-items: center;"> <div style="border: 1px solid black; padding: 2px 5px;">T</div> <div style="border: 1px solid black; padding: 2px 5px;">C</div> <div style="border: 1px solid black; padding: 2px 5px;">M</div> <div style="border: 1px solid black; padding: 2px 5px;">D</div> <div style="border: 1px solid black; padding: 2px 5px;">#</div> <div style="border: 1px solid black; padding: 2px 5px;">0</div> <div style="border: 1px solid black; padding: 2px 5px;">0</div> <div style="border: 1px solid black; padding: 2px 5px;">0</div> </div> <p style="text-align: center;">PART NUMBER</p>	
AGENCY CERTIFIED/PACKAGE	CTR (%)
UL, cUL, FIMKO, BSI, VDE	> 600
SOP-4	TCMD1000
SOP-16, quad channel	TCMD4000

ABSOLUTE MAXIMUM RATINGS (T _{amb} = 25 °C, unless otherwise specified)				
PARAMETER	TEST CONDITION	SYMBOL	VALUE	UNIT
INPUT				
Reverse voltage		V _R	6	V
Forward current		I _F	60	mA
Forward surge current	t _p ≤ 10 μs	I _{FSM}	1.5	A
Power dissipation		P _{diss}	100	mW
Junction temperature		T _j	125	°C

**ABSOLUTE MAXIMUM RATINGS** ($T_{amb} = 25\text{ }^{\circ}\text{C}$, unless otherwise specified)

PARAMETER	TEST CONDITION	SYMBOL	VALUE	UNIT
OUTPUT				
Collector emitter voltage		V_{CEO}	35	V
Emitter collector voltage		V_{ECO}	7	V
Collector current		I_C	80	mA
Collector peak current	$t_p/T = 0.5, t_p \leq 10\text{ ms}$	I_{CM}	100	mA
Power dissipation		P_{diss}	150	mW
Junction temperature		T_j	125	$^{\circ}\text{C}$
COUPLER				
AC isolation test voltage (RMS)		$V_{ISO}^{(1)}$	3750	V_{RMS}
Total power dissipation		P_{tot}	250	mW
Operating ambient temperature range		T_{amb}	- 40 to + 100	$^{\circ}\text{C}$
Storage temperature range		T_{stg}	- 40 to + 125	$^{\circ}\text{C}$
Soldering temperature ⁽²⁾		T_{sld}	260	$^{\circ}\text{C}$

Notes

- Stresses in excess of the absolute maximum ratings can cause permanent damage to the device. Functional operation of the device is not implied at these or any other conditions in excess of those given in the operational sections of this document. Exposure to absolute maximum ratings for extended periods of the time can adversely affect reliability.

⁽¹⁾ Related to standard climate 23/50 DIN 50014.

⁽²⁾ Wave soldering three cycles are allowed. Also refer to "Assembly Instruction" (www.vishay.com/doc?80054).

ELECTRICAL CHARACTERISTICS ($T_{amb} = 25\text{ }^{\circ}\text{C}$, unless otherwise specified)

PARAMETER	TEST CONDITION	SYMBOL	MIN.	TYP.	MAX.	UNIT
input						
Forward voltage	$I_F = 50\text{ mA}$	V_F		1.25	1.6	V
Junction capacitance	$V_R = 0\text{ V}, f = 1\text{ MHz}$	C_j		50		pF
output						
Collector emitter voltage	$I_C = 100\text{ }\mu\text{A}$	V_{CEO}	35			V
Emitter collector voltage	$I_E = 100\text{ }\mu\text{A}$	V_{ECO}	7			V
Collector dark current	$V_{CE} = 10\text{ V}, I_F = 0, E = 0$	I_{CEO}			100	nA
coupler						
Collector emitter saturation voltage	$I_F = 20\text{ mA}, I_C = 5\text{ mA}$	V_{CEsat}			1	V
Cut-off frequency	$I_F = 10\text{ mA}, V_{CE} = 5\text{ V}, R_L = 100\text{ }\Omega$	f_c		10		kHz
Coupling capacitance	$f = 1\text{ MHz}$	C_k		0.3		pF

Note

- Minimum and maximum values are testing requirements. Typical values are characteristics of the device and are the result of engineering evaluation. Typical values are for information only and are not part of the testing requirements.

CURRENT TRANSFER RATIO ($T_{amb} = 25\text{ }^{\circ}\text{C}$, unless otherwise specified)

PARAMETER	TEST CONDITION	PART	SYMBOL	MIN.	TYP.	MAX.	UNIT
I_C/I_F	$V_{CE} = 2\text{ V}, I_F = 1\text{ mA}$	TCMD1000	CTR	600	800		%
		TCMD4000	CTR	600	800		%

SWITCHING CHARACTERISTICS ($T_{amb} = 25\text{ }^{\circ}\text{C}$, unless otherwise specified)

PARAMETER	TEST CONDITION	SYMBOL	MIN.	TYP.	MAX.	UNIT
Rise time	$V_{CE} = 2\text{ V}, I_C = 10\text{ mA}, R_L = 100\text{ }\Omega$ (see figure 1)	t_r		300		μs
Turn-off time	$V_{CE} = 2\text{ V}, I_C = 10\text{ mA}, R_L = 100\text{ }\Omega$ (see figure 1)	t_{off}		250		μs

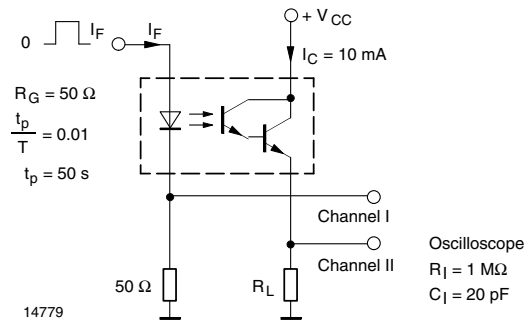

Fig. 1 - Test Circuit, Non-Saturated Operation

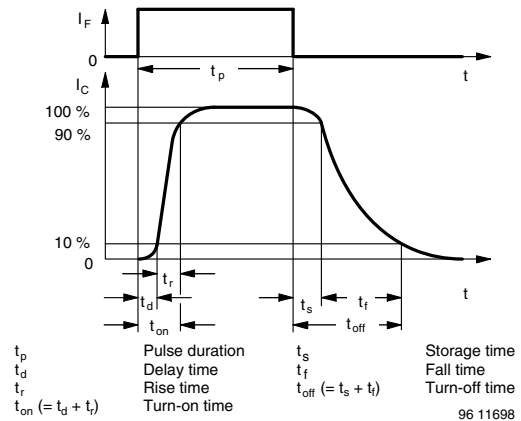

Fig. 2 - Switching Times

SAFETY AND INSULATION RATINGS						
PARAMETER	TEST CONDITION	SYMBOL	MIN.	TYP.	MAX.	UNIT
Climatic classification	IEC 68 part 1			40/110/21		
Comparative tracking index		CTI	175		399	
V _{IOTM}			6000			V
V _{IORM}			707			V
P _{SO}					265	mW
I _{SI}					130	mA
T _{SI}					150	°C
Creepage distance			5			mm
Clearance distance			5			mm
Insulation thickness, reinforce rated	per IEC 60950 2.10.5.1		0.4			mm

Note

- As per IEC 60747-5-2, § 7.4.3.8.1, this optocoupler is suitable for “safe electrical insulation” only within the safety ratings. Compliance with the safety ratings shall be ensured by means of protective circuits.

TYPICAL CHARACTERISTICS (T_{amb} = 25 °C, unless otherwise specified)

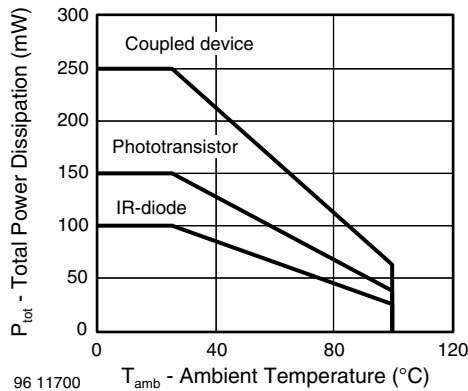

Fig. 3 - Forward Voltage vs. Ambient Temperature

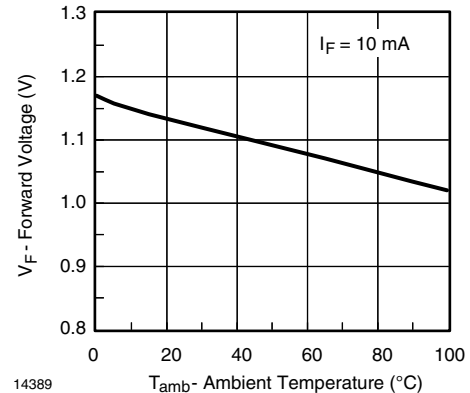

Fig. 4 - Forward Voltage vs. Ambient Temperature



Fig. 5 - Forward Current vs. Forward Voltage

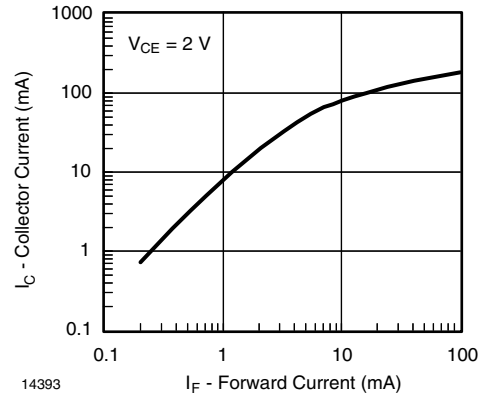

Fig. 8 - Collector Current vs. Forward Current



Fig. 6 - Relative Current Transfer Ratio vs. Ambient Temperature



Fig. 9 - Collector Current vs. Collector Emitter Voltage

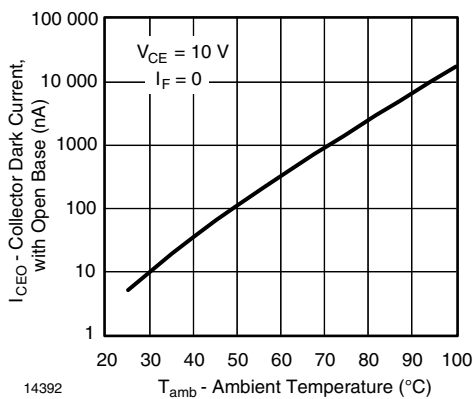

Fig. 7 - Collector Dark Current vs. Ambient Temperature



Fig. 10 - Collector Emitter Saturation Voltage vs. Collector Current

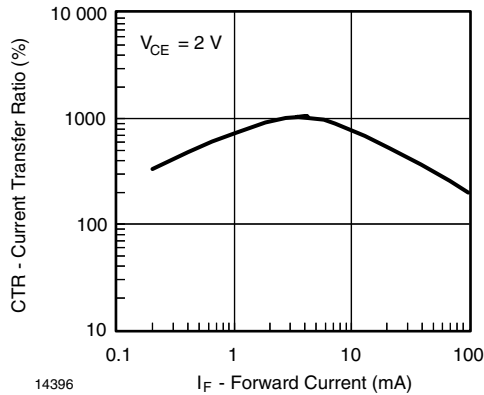
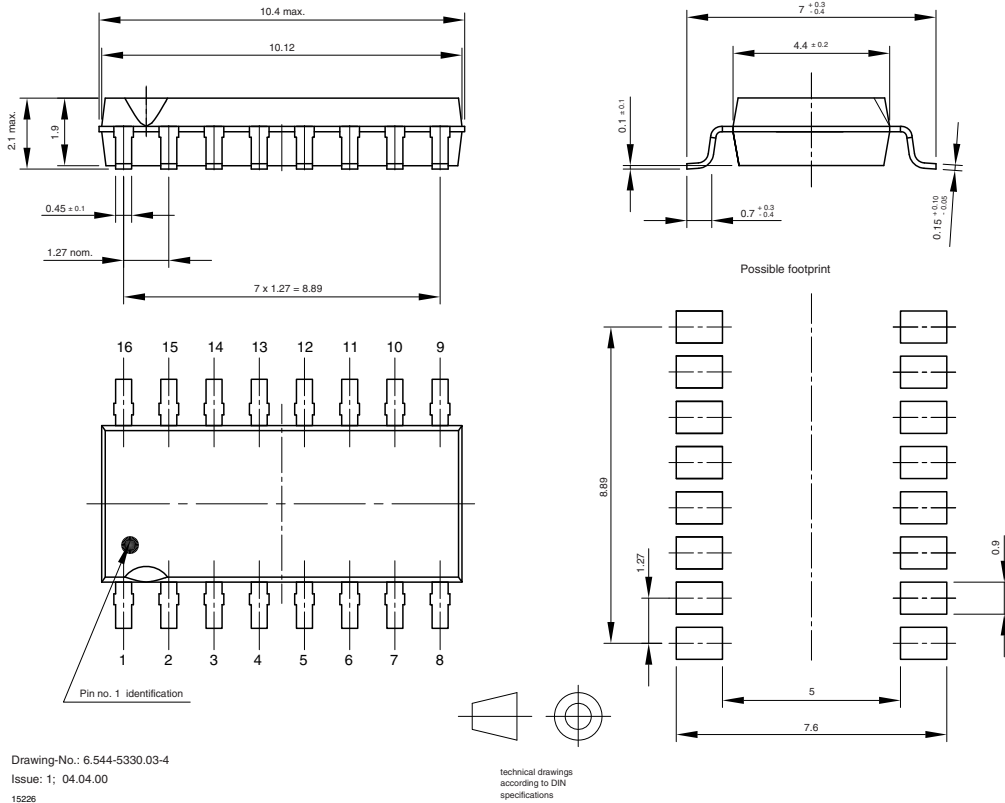

Fig. 11 - Current Transfer Ratio vs. Forward Current

PACKAGE DIMENSIONS in millimeters





Drawing-No.: 6.544-5330.03-4
 Issue: 1; 04.04.00
 15226

PACKAGE MARKING

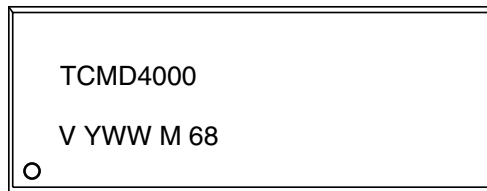
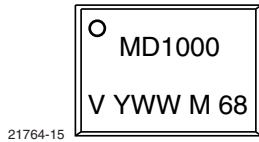



Disclaimer

ALL PRODUCT, PRODUCT SPECIFICATIONS AND DATA ARE SUBJECT TO CHANGE WITHOUT NOTICE TO IMPROVE RELIABILITY, FUNCTION OR DESIGN OR OTHERWISE.

Vishay Intertechnology, Inc., its affiliates, agents, and employees, and all persons acting on its or their behalf (collectively, "Vishay"), disclaim any and all liability for any errors, inaccuracies or incompleteness contained in any datasheet or in any other disclosure relating to any product.

Vishay makes no warranty, representation or guarantee regarding the suitability of the products for any particular purpose or the continuing production of any product. To the maximum extent permitted by applicable law, Vishay disclaims (i) any and all liability arising out of the application or use of any product, (ii) any and all liability, including without limitation special, consequential or incidental damages, and (iii) any and all implied warranties, including warranties of fitness for particular purpose, non-infringement and merchantability.

Statements regarding the suitability of products for certain types of applications are based on Vishay's knowledge of typical requirements that are often placed on Vishay products in generic applications. Such statements are not binding statements about the suitability of products for a particular application. It is the customer's responsibility to validate that a particular product with the properties described in the product specification is suitable for use in a particular application. Parameters provided in datasheets and/or specifications may vary in different applications and performance may vary over time. All operating parameters, including typical parameters, must be validated for each customer application by the customer's technical experts. Product specifications do not expand or otherwise modify Vishay's terms and conditions of purchase, including but not limited to the warranty expressed therein.

Except as expressly indicated in writing, Vishay products are not designed for use in medical, life-saving, or life-sustaining applications or for any other application in which the failure of the Vishay product could result in personal injury or death. Customers using or selling Vishay products not expressly indicated for use in such applications do so at their own risk. Please contact authorized Vishay personnel to obtain written terms and conditions regarding products designed for such applications.

No license, express or implied, by estoppel or otherwise, to any intellectual property rights is granted by this document or by any conduct of Vishay. Product names and markings noted herein may be trademarks of their respective owners.

Material Category Policy

Vishay Intertechnology, Inc. hereby certifies that all its products that are identified as RoHS-Compliant fulfill the definitions and restrictions defined under Directive 2011/65/EU of The European Parliament and of the Council of June 8, 2011 on the restriction of the use of certain hazardous substances in electrical and electronic equipment (EEE) - recast, unless otherwise specified as non-compliant.

Please note that some Vishay documentation may still make reference to RoHS Directive 2002/95/EC. We confirm that all the products identified as being compliant to Directive 2002/95/EC conform to Directive 2011/65/EU.

Vishay Intertechnology, Inc. hereby certifies that all its products that are identified as Halogen-Free follow Halogen-Free requirements as per JEDEC JS709A standards. Please note that some Vishay documentation may still make reference to the IEC 61249-2-21 definition. We confirm that all the products identified as being compliant to IEC 61249-2-21 conform to JEDEC JS709A standards.

Данный компонент на территории Российской Федерации

Вы можете приобрести в компании MosChip.

Для оперативного оформления запроса Вам необходимо перейти по данной ссылке:

<http://moschip.ru/get-element>

Вы можете разместить у нас заказ для любого Вашего проекта, будь то серийное производство или разработка единичного прибора.

В нашем ассортименте представлены ведущие мировые производители активных и пассивных электронных компонентов.

Нашей специализацией является поставка электронной компонентной базы двойного назначения, продукции таких производителей как XILINX, Intel (ex.ALTERA), Vicor, Microchip, Texas Instruments, Analog Devices, Mini-Circuits, Amphenol, Glenair.

Сотрудничество с глобальными дистрибьюторами электронных компонентов, предоставляет возможность заказывать и получать с международных складов практически любой перечень компонентов в оптимальные для Вас сроки.

На всех этапах разработки и производства наши партнеры могут получить квалифицированную поддержку опытных инженеров.

Система менеджмента качества компании отвечает требованиям в соответствии с ГОСТ Р ИСО 9001, ГОСТ РВ 0015-002 и ЭС РД 009

Офис по работе с юридическими лицами:

105318, г.Москва, ул.Щербаковская д.3, офис 1107, 1118, ДЦ «Щербаковский»

Телефон: +7 495 668-12-70 (многоканальный)

Факс: +7 495 668-12-70 (доб.304)

E-mail: info@moschip.ru

Skype отдела продаж:

moschip.ru

moschip.ru_4

moschip.ru_6

moschip.ru_9