

MLX75027 VGA Time-of-Flight Sensor

PRELIMINARY DATASHEET v0.8

Features & Benefits

- 1/2" optical Time-of-Flight image sensor
- VGA (640 x 480) pixel array
- 10 x 10 μm DepthSense™ pixels
- Integrated microlenses
- Backside illumination (BSI technology)
- External quantum efficiency 51% (850nm)
- External quantum efficiency 28% (940nm)
- High distance accuracy due to programmable modulating frequencies up to 100 MHz
- AC Demodulation contrast >85 % (50 MHz)
- AC Demodulation contrast >69 % (100 MHz)
- Differential light source control with phase delay feedback loop
- Full resolution distance framerate of max. 135 FPS (4 phases, Tint 300 μs , 4lane data @960mbps MIPI configuration)
- Up to 8 raw phases (or quads) per frame
- Per-phase statistics & diagnostics
- Continuous or triggered operation mode(s)
- Configurable over I²C (up to 400kHz)
- CSI-2 serial data output, MIPI D-PHY, 1 clock lane, 2 or 4 data lanes (< 960 Mbps/lane)
- Build-in temperature sensor
- Region of interest (ROI) selection
- Integrated support for binning (2x2, 4x4, 8x8)
- Horizontal mirror & vertical flip image modes
- 14 x 14 x 2.2 mm ceramic BGA package
- Number of pins = 141
- Ambient operating temperature range of -40 - 105°C
- AEC-Q100 qualified (grade 2)

Description

MLX75027 is a fully integrated optical Time-of-Flight image sensor. It's perfectly suited for automotive applications, including, but not limited to, gesture recognition, driver monitoring, skeleton tracking, people or obstacle detection and traffic monitoring. The sensor features a VGA (640x480) pixel array based on the DepthSense™ pixel technology. Combined with a modulated light source this sensor is capable of measuring object distance and reflectivity under extreme background light conditions. This distance information can be used to calculate a complete 3D point cloud representation of a scene. Full resolution image acquisition up to 135 distance frames per second while supplied to a microcontroller via a standardized MIPI CSI-2 serial camera interface. The device is available in a ceramic BGA package and offers a variety of integration possibilities.

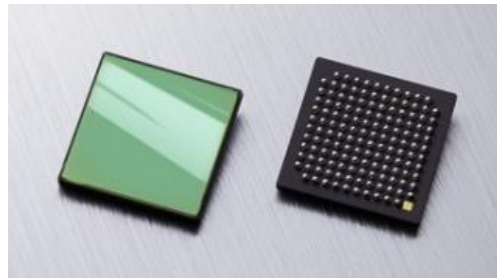

Melexis reserves the right to change products and specifications without prior notice.

The information does not convey any license by any implication or otherwise under any patents or other right. Application circuits shown, if any, are typical examples illustrating the operation of the device. Melexis cannot assume responsibility for any problems arising out of the use of these circuits.

Table of Contents

Features & Benefits	1
Description.....	1
Table of Contents	2
Document Revision History.....	5
Ordering Information	6
1. System Architecture	7
2. Sensor Block Diagram	8
3. Electrical Specifications.....	9
3.1. Absolute Maximum Ratings.....	9
3.2. Typical Operating Conditions.....	9
3.3. Video Interface	10
3.4. Power Consumption	11
3.5. Maximum Distance Frame Rate	12
3.6. Decoupling Recommendations.....	13
3.7. Power-up Sequence.....	13
3.8. Input Clock Requirements	13
3.9. I ² C Specifications.....	14
4. Optical Characteristics	15
4.1. VGA Pixel Array Configuration.....	15
4.2. Pixel & Image Array Characteristics.....	16
4.3. CRA (Chief Ray Angle)	17
4.4. MTF (Modulation Transfer Function)	18
4.5. Application Lens Design Recommendations.....	18
5. Communication Interface(s)	19
5.1. I ² C (Inter-Integrated Circuit)	19
5.2. MIPI Alliance CSI-2 Description.....	23
6. Start-up Sequence	25
6.1. Initialization Process	26
6.2. Initialization Register Map.....	27
7. Register Settings.....	29
7.1. Video Output Configuration	29
7.2. Modes of Operation	30
7.3. Data Output Modes	31

7.4. HMAX & Frame Read-Out Time	32
7.5. PARAM_HOLD.....	34
7.6. USER_ID Register	34
7.7. Modulation Frequency	35
7.8. Frame Structure & Frame Rate.....	36
7.9. FRAME_STARTUP	37
7.10. FRAME_TIME	37
7.11. PHASE_COUNT.....	37
7.12. Px_PREHEAT, Px_PREMIX, Px_PRETIME	38
7.13. Px_INTEGRATION.....	40
7.14. Px_PHASE_SHIFT.....	41
7.15. Px_PHASE_IDLE (or V-blanking).....	42
7.16. Px_LEDEN.....	42
7.17. Px_DMIX0, Px_DMIX1 & Px_STATIC_LED	43
7.18. Pixel Binning.....	44
7.19. Region of Interest (ROI)	45
7.20. Flip & Mirror	46
7.21. Temperature Sensor	46
7.22. Pixel & Phase Statistics	47
7.23. PN9 Test Pattern.....	50
7.24. Duty Cycle Adjustment	51
7.25. Illumination Signal (subLVDS or CMOS).....	52
8. MetaData Description.....	52
8.1. Embedded Data Format in 4 Lane MIPI Configuration.....	53
8.2. Embedded Data Format in 2 Lane MIPI Configuration.....	53
9. Distance & Amplitude Calculation	54
10. Package Information.....	55
10.1. Transmittance and reflectivity.....	55
10.2. Pinout & Equivalent I/O Circuitry	56
10.3. Mechanical Dimensions.....	60
10.4. Package Marking.....	60
10.5. PCB Landing Pattern	60
10.6. Reflow Solder Profile	61
10.7. Reflow Cleaning Instructions	61
10.8. Moisture Sensitivity Level.....	61

Disclaimer 62

Document Revision History

Version	Date	Changes
0.1 - 0.7	/	Draft version(s)
0.8	16/10/2019	Section 7.22: Changed rst value of STATS_EN from 0x00 to 0x01
		Section 3.2: Added TRIG + SLASEL + LEDFB: VIL / VIH electrical parameters to the typical operating conditions
		Section 3.3: Added DC/AC MIPI specifications to the video interface
		Section 7.8: Minor updates of the frame structure definition and contents
		Section 7.21: Specified temperature sensor register value readout below -40 degrees
		Section 10.1: Update the transmittance graph based on latest data and renamed section to transmittance and reflectivity
		Section 3.1: Update supply naming convention: VIF is VDDIF thus is removed and replaced by VDDIF
		Correction of the option code description of the version with cover tape in ordering information
		Section 3.2: Added the recommended typical supply voltages to the typical operating condition
		Section 4.2: Decreased typical pixel dark noise level
		Section 7.12: Added boundary condition to the RANDNM7 definition
		Section 4.4: Added the Modulation Transfer Function graph
		Overall grammatical corrections
		Section 4.2: Update of the external quantum efficiency
		Section 10.5: Added solder pad dimensions to the landing pattern information
		Section 9: Corrected the distance calculation based on raw data frames
Section 7.4: Updated single phase readout time in function of HMAX values		
Section 7.2: Split the continuous mode of operation into continuous and software triggered mode.		
Section 10.2: Removed the dubious naming between RESETB and <u>RESET</u> to RESETB		
Section 3.2: Added accuracy of the temperature sensor for three different temperatures to typical operating condition		

Table 1: Changelog

Ordering Information

Product	Temperature Rating	Package Identifier	Option Code	Packing Style
MLX75027	R	TC	ABA-200	TR
MLX75027	R	TC	ABA-210	TR

Table 2: Device ordering information

Temperature Rating	R : -40°C to 105°C
Package Identifier	TC : Ceramic ball grid array
Option Code	AAA-200 : engineering samples (obsolete) ABA-200 : incl. double sided ARC coating, no optical filter (available in sample pack of 10 pieces) ABA-210 : version ABA-200 with cover tape
Packing Style	TR : Tray
Ordering Example	MLX75027RTC-ABA-200-TR

Table 3: Ordering options

1. System Architecture

A complete TOF system or camera module includes at least these components:

- MLX75027 VGA (640x480 pixels) TOF pixel array
- A synchronized high bandwidth near infrared (NIR) active illumination source
- Beam shaping optics for the light distribution
- A receiving sensor lens (optimized for maximum NIR wavelength transmittance)
- A microprocessor, DSP, FPGA or SOC (system on chip) to calculate and process the data, compatible with MIPI camera serial interface CSI-2

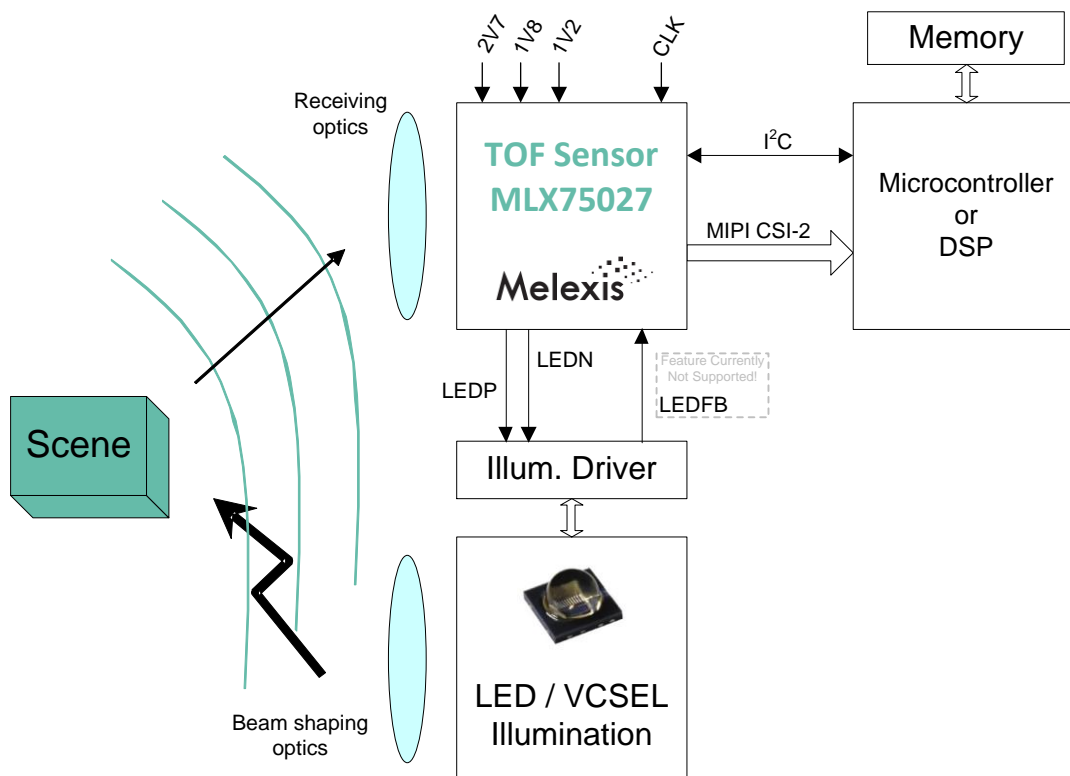

Figure 1: System block diagram

2. Sensor Block Diagram

MLX75027 is a Time-of-Flight (TOF) camera sensor with two tap Current Assisted Photo Demodulator (CAPD) pixels offering high responsivity. These backside illuminated pixels are connected to low noise analog amplifiers and converted by column ADCs which enable high speed & accurate image acquisition. Furthermore it consists of a PLL timing generator, a high speed CSI2 serial interface, controllable registers via I²C and a digital control unit in charge of the different internal blocks.

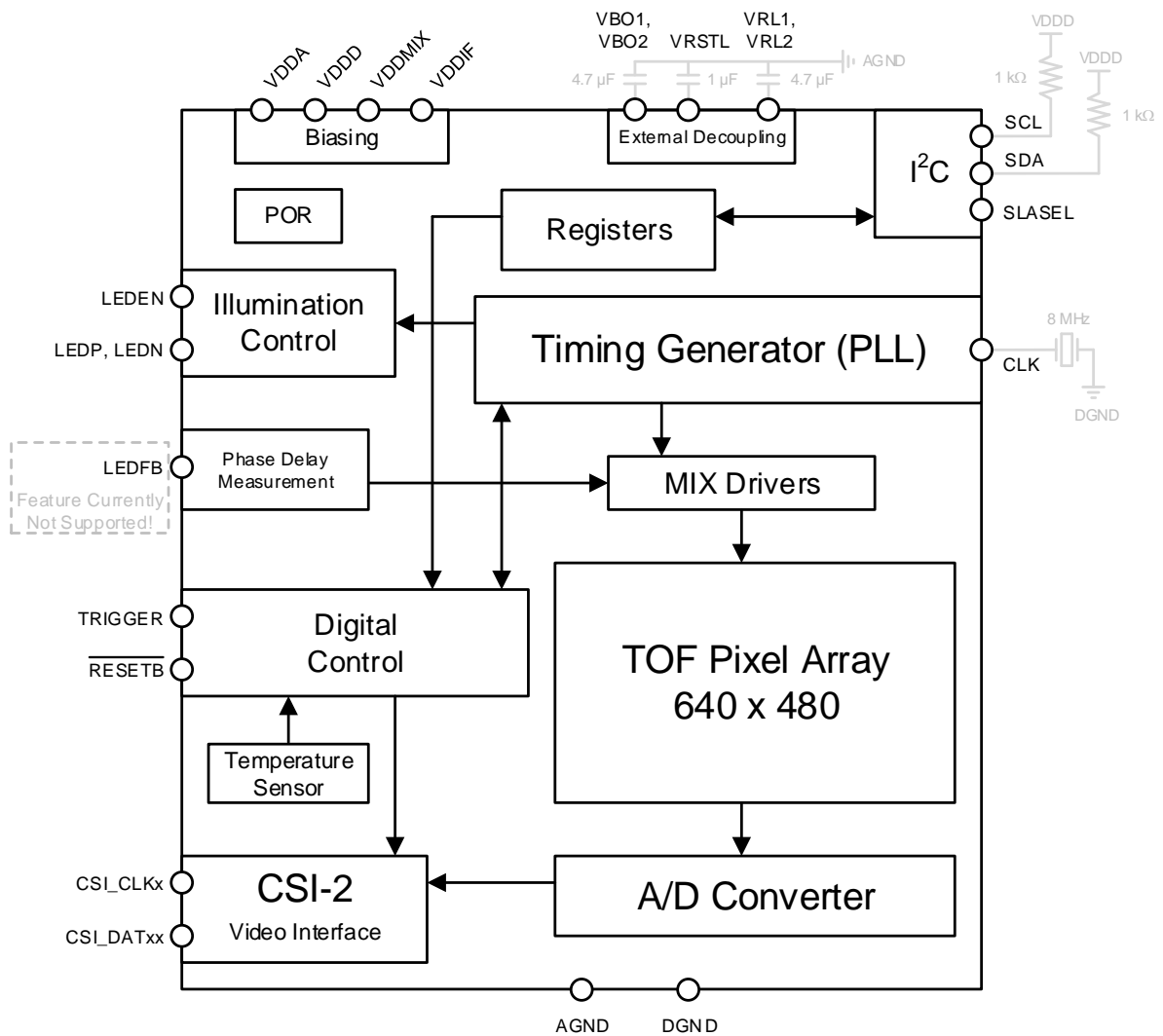

Figure 2: Sensor block diagram

3. Electrical Specifications

3.1. Absolute Maximum Ratings

Parameter	Symbol	Min.	Max.	Unit
Supply voltage (analog)	VDDA	-0.3	3.3	V
Supply voltage (MIX drivers)	VDDMIX	-0.3	1.8	V
Supply voltage (digital)	VDDD	-0.3	1.8	V
Supply voltage (interfaces)	VDDIF	-0.3	3.3	V
Input voltage (digital IOs)	VI	-0.3	3.3	V
Output voltage (digital IOs)	VO	-0.3	3.3	V
Storage temperature		-40	125	°C

Table 4: Absolute Maximum Ratings

Note : Absolute maximum ratings should not be exceeded at any time to avoid permanent hardware damage.

3.2. Typical Operating Conditions

Parameter	Min.	Typ.	Max.	Unit
VDDA Supply Voltage ¹	2.6	2.7	2.8	V
VDDMIX Supply Voltage ¹	1.1	1.2	1.3	V
VDDD Supply Voltage ¹	1.1	1.2	1.3	V
VDDIF Supply Voltage ¹	1.7	1.8	1.9	V
LEDP, LEDN single ended high level ² LEDEN ²	VDDIF - 0.2			V
LEDP, LEDN single ended low level ³ LEDEN ³			0.2	V
LEDP/LEDN differential common mode (LVDS_EN = 1)	VDDIF / 2 - 0.1	VDDIF / 2	VDDIF / 2 + 0.1	mV
LEDP/LEDN differential swing (with R = 100Ω, LVDS_EN = 1)	100	150	220	mV
LEDP, LEDN termination resistor		100		Ohm
Minimum TRIGGER pulse length		1		μs
Minimum RESETB pulse length		1		μs
TRIGGER RESETB SLASEL LEDFB	Maximum input low		0.2* VDDIF	V
TRIGGER RESETB SLASEL LEDFB	Minimum input high	0.8* VDDIF		V
Junction to Ambient Thermal Resistance		25		K/W
Operating ambient temperature	-40		105	°C
Temperature sensor accuracy	@ -40°C Tj @ 60°C Tj @ 125°C Tj		±7 ±5 ±6	°C

Table 5: Typical Operating Conditions

Note¹: It is recommended to use the typical supply voltages

Note²: current of -2mA, LVDS_EN = 0, typical load 15pF

Note³: current of 2mA, LVDS_EN = 0, typical load 15pF

3.3. Video Interface

MLX75027 is fully compliant with the hardware description as described in the MIPI Alliance Specification for D-PHY version 1.20.00, released in September 2014. For a more detailed description about the parameters please consult the D-PHY MIPI documentation.

3.3.1. MIPI DC specification

	Parameter	Min.	Typ.	Max.	Unit
HSDC	VOHHS			360	mV
	VOD	140		270	mV
	dVOD			14	mV
	VCMTX	150		250	mV
	dVCMTX			5	mV
	ZOS	40		62.5	Ω
LPDC	VOH	1.1		1.3	V
	VOL	-50		50	mV
	ZOLP	110			Ω

Table 6: MIPI DC specification

Note: For a detailed explanation of the different parameters, please consult the MIPI D-PHY specifications v1.20.00.

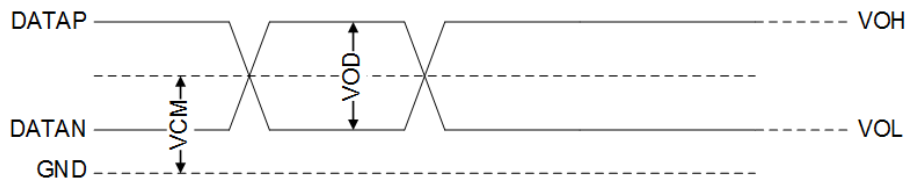

Figure 3: MIPI DC layout

3.3.2. MIPI AC specification

	Parameter	Min.	Typ.	Max.	Unit
HSAC	Trise, Tfall	50		312.5	psec
	dVCMTX(>400MHz)			15	mVrms
	dVCMTX(50-400MHz)			25	mVpeak
LPAC	Trise, Tfall			25	ns
	Slew rate with Cload=0pF			500	mV/nsec
	Slew rate with Cload=5pF			300	mV/nsec
	Slew rate with Cload=20pF			250	mV/nsec
	Slew rate with Cload=70pF			150	mV/nsec

Table 7: MIPI AC specification

Note: For a detailed explanation of the different parameters, please consult the MIPI D-PHY specifications v1.20.00.

3.4. Power Consumption

Parameter	Symbol	Application A		Application B		Peak. ³	Unit
		Typ. ¹	Max. ²	Typ. ¹	Max. ²		
Analog Supply Voltage	VDDA	2.7 ± 0.1		2.7 ± 0.1			V
Analog Supply Current	IDDA	10.5	10.8	15.6	16	39	mA
MIX Drivers Supply Voltage	VDDMIX	1.2 ± 0.1		1.2 ± 0.1			V
MIX Drivers Supply Current	IDDMIX	69.9	101.3	292.9	424.7	2784	mA
Digital Supply Voltage	VDDD	1.2 ± 0.1		1.2 ± 0.1			V
Digital Supply Current	IDDD	87.8	100.7	104.4	119.8	181	mA
I/O Supply Voltage	VDDIF	1.8 ± 0.1		1.8 ± 0.1			V
I/O Supply Current	IDDIF	1.9	2.2	2.3	2.6	3	mA
Power Consumption ⁵	P	221	275	523	757.6		mW

Table 8: Power consumption

Note¹ : Typical values are the average power consumption with nominal voltage levels (at room temperature) for two defined application conditions.

Application A : Typical

- Full resolution (640x480 pixels)
- 4 raw phases per distance frame
- 30 distance frames per second
- 250 μs integration time
- 60 MHz modulation frequency
- 800 mbps (4 lane MIPI data rate)

Application B : Performance

- Full resolution (640x480 pixels)
- 4 raw phases per distance frame
- 60 distance frames per second
- 600 μs integration time
- 100 MHz modulation frequency
- 960 mbps (4 lane MIPI data rate)

Note² : Maximum values are typical values in worst case conditions⁴

Note³ : Peak values are the maximum instant current during the most active period in worst case conditions⁴

Note⁴ : Worst case conditions take into account manufacturing process variation & the full ambient temperature range

Note⁵ : The total power consumption is dominated by the integration duty cycle, calculated as $4 * \text{integration time (in } \mu\text{s)} * \text{distance FPS} / 10^4$, as shown in Figure 4.

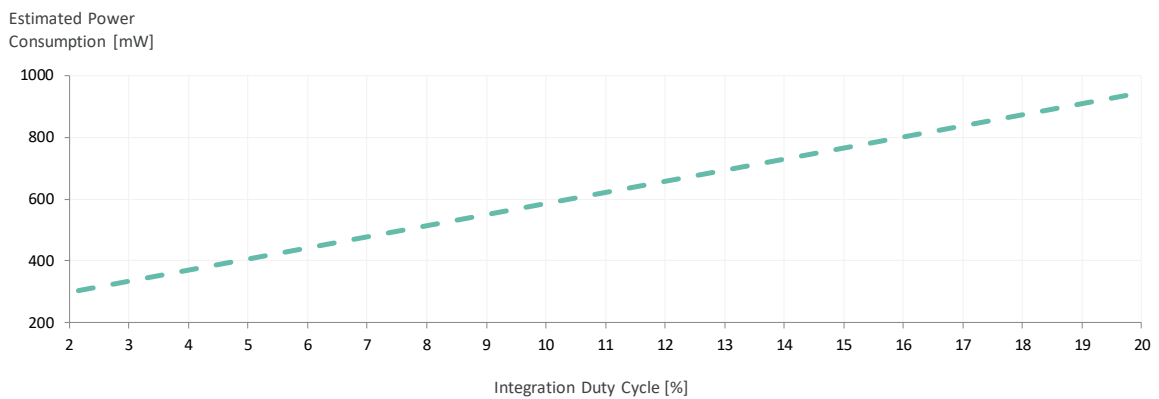

Figure 4: Maximum device power consumption in function of the integration duty cycle

3.5. Maximum Distance Frame Rate

The maximum distance frame rate that can be achieved depends on the integration time, the minimum readout time per phase and the total amount of raw phases for each distance frame. The phase readout time is determined by the MIPI configuration settings as explained in section 7.4.

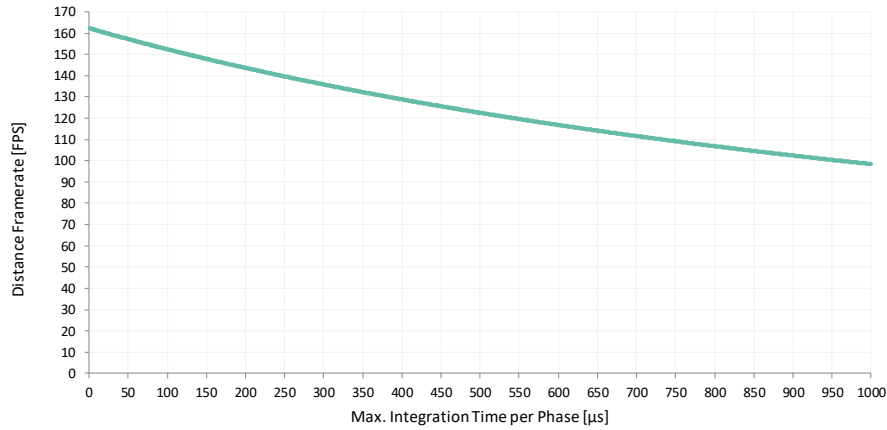

Figure 5: Theoretical Maximum Distance Frame Rate in function of Integration Time (per phase)

Figure 5 presents the theoretical maximum distance frame rate for a 4 lane data output at 960 Mbps, however it does not take into account any thermal limitations. Higher integration time also increases the power consumption (Figure 4) and thus device self-heating. For safe operation within the automotive ambient temperature range of -40 - 105 °C this self-heating must be limited to 20 °C. Each PCB design has a unique thermal behaviour, but a typical junction to ambient thermal resistance (θ_{JA}) of 25 K/W would limit the sensor power consumption to 800 mW, corresponding to an illumination duty cycle of 16%.

A review of the theoretical maximum distance frame rate with these thermal limitations results in an updated maximum distance frame rate as shown in Figure 6.

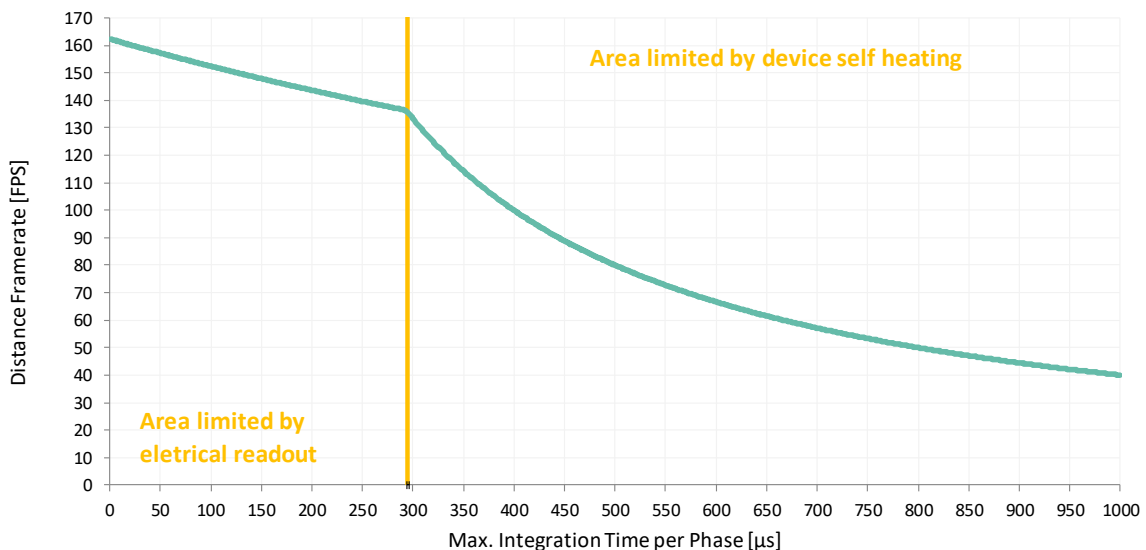

Figure 6: Practical Maximum Distance Frame Rate in function of Integration Time (per phase)

3.6. Decoupling Recommendations

It is generally known that sensor performance can degrade with noisy input supplies. Specifications in this datasheet are only valid when stable voltage levels are available. Common decouple techniques use a two-step architecture consisting of a small capacitor (~10-100nF) as close as possible to the supply pin, combined with a bigger capacitor further away from the device, both connected to a low impedance ground plane to minimize inductance. Additionally a small series ferrite bead can be used to keep high frequency noise outside of the IC, but also to keep internally generated noise from propagating to the rest of the system.

External Voltage Supplies

- VDDA : min. 4.7μF
- VDDMIX : min. 100nF & 4.7μF
- VDDD : min. 100nF & 4.7μF
- VDDIF : min. 100nF & 1μF

Internal Generated Voltage Supplies

- VBO1, VBO2 : min. 4.7μF
- VRSTL : min. 1μF
- VRL1, VRL2 : min. 4.7μF

These recommendations are based on analysis of different available hardware platforms. Each new hardware design requires an individual analysis to find & optimize the correct decoupling strategy.

3.7. Power-up Sequence

VDDD and VDDMIX use 1V2 as supply and it is possible to combine them on a single regulator source. However, VDDMIX exhibits high peak currents during the integration time that could compromise the stability of VDDD. Instantaneous voltage drops on VDDD need to be avoided and it is recommended to use two separate regulators instead.

With 2 regulators it is mandatory that VDDD is enabled simultaneously or not later than VDDMIX, and that VDDMIX is disabled before VDDD on power-down. More detailed power-up timings can be found in chapter 6. A slew rate of maximum 25 mV/μs has been specified for each power supply to avoid oscillations during power-up.

3.8. Input Clock Requirements

MLX75027 requires a fixed clock input signal of 8 MHz generated by an external crystal oscillator.

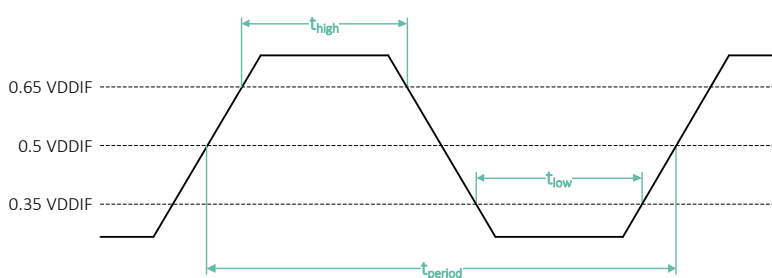

Figure 7: CLK square waveform input diagram

Parameter	Symbol	Min.	Typ.	Max.	Unit
CLK high level	CLK _{HIGH}	1.2			V
CLK low level	CLK _{LOW}			0.6	V
CLK frequency			8		MHz
CLK low level width	t _{low}	50	62.5	75	ns
CLK high level width	t _{high}	50	62.5	75	ns
CLK jitter				600	ps

Table 9: CLK input characteristics

3.9. I²C Specifications

MLX75027 features a standard (up to 400 kHz) inter-integrated circuit communication interface, known as I²C. The sensor operates as I²C slave with default slave address of 0x67. This address can be changed via the external PIN SLASEL (more information can be found in section 5.1.6). The master I²C device is responsible to initiate all communication, it is in control of the clock line (SCL) & sends data via the SDA line. Each I²C slave on the bus monitors this communication and will respond to the master when requested.

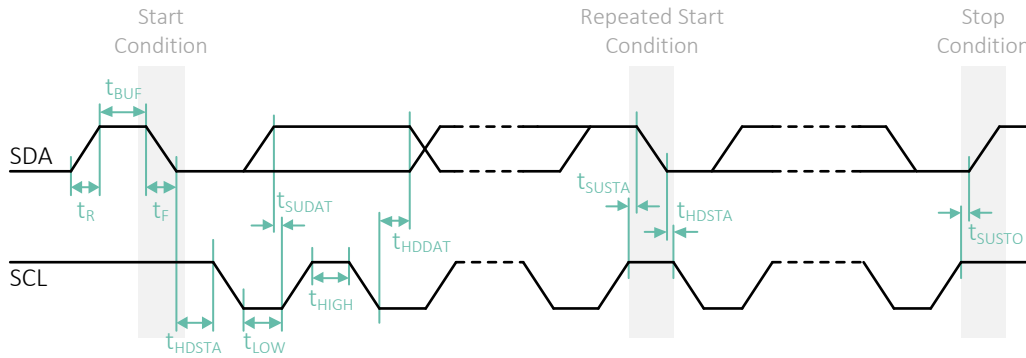

Figure 8: I²C serial communication diagram

Parameter	Symbol	Condition	Min.	Max.	Unit
Low level input voltage	V _{IL}		-0.3	0.3*VDDIF	V
High level input voltage	V _{IH}		0.7*VDDIF	1.9	V
Low level output voltage	V _{OL}	VDDIF > 2V, sink 3mA	0	0.2*VDDIF	V
Output fall time	t _{of}	Load 10pF - 400 pF 0.7*VDDIF - 0.3*VDDIF		250	ns
Input current	I _i	0.1*VDDIF - 0.9*VDDIF	-10	10	μA
SDA I/O capacitance	C _{I/O}			10	pF
SCL input capacitance	C _I			10	pF

Table 10: I²C Electrical Specifications

Parameter	Symbol	Min.	Max.	Unit
SCL clock frequency	f _{SCL}	0	400	kHz
Rise time (SCD & SCL)	t _R		300	ns
Fall time (SDA & SCL)	t _F		300	ns
Hold time (start condition)	t _{HDSTA}	0.6		ns
Setup time (rep.-start condition)	t _{SUSTA}	0.6		μs
Setup time (stop condition)	t _{SUSTO}	0.6		μs
Data setup time	t _{SUDAT}	100		μs
Data hold time	t _{HDDAT}	0	0.9	μs
Bus free time between stop and start condition	t _{BUF}	1.3		μs
Low period of the SCL clock	t _{LOW}	1.3		μs
High period of the SCL clock	t _{HIGH}	0.6		μs

Table 11: I²C Fast Mode Specifications

4. Optical Characteristics

4.1. VGA Pixel Array Configuration

The pixel array has a total of 640 x 480 DepthSense™ pixels. Each pixel consists of 2 individual taps called tap A and tap B. Information from both taps is needed for a reliable distance calculation. The data format (or output modes) available via the MIPI CSI2 video interface can be selected by the user and are described in more detail in section 7.3. The pixels are read out from bottom left, to top right, first horizontally, afterwards vertically, like indicated in this figure. This picture represents the physical pixel orientation, please note that output will have pixel 1 on top left to compensate for the lens by default as explained in section 7.20.

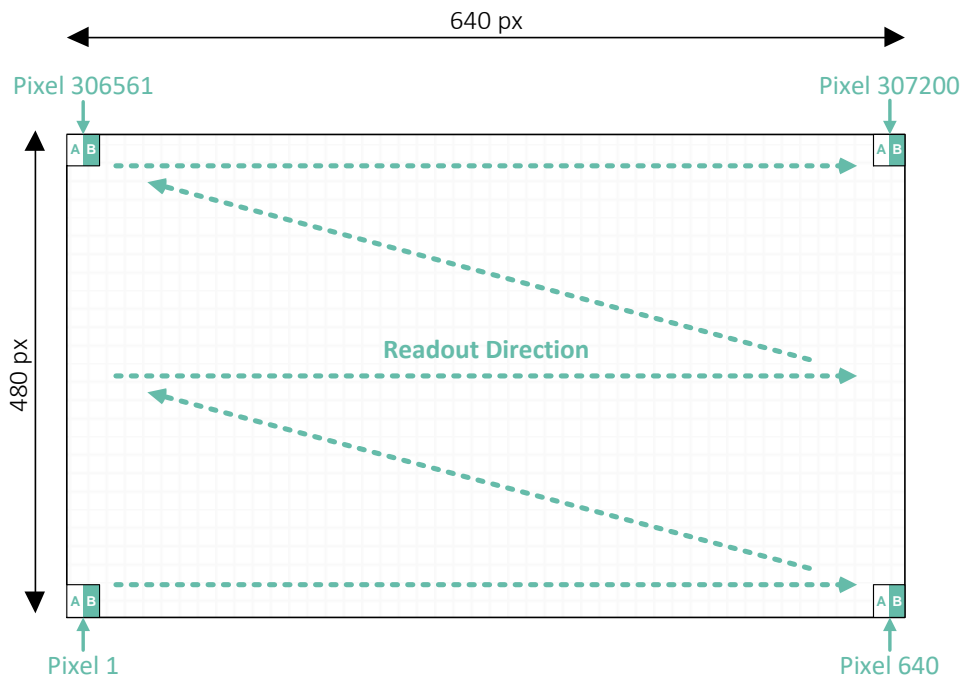

Figure 9: VGA readout

4.2. Pixel & Image Array Characteristics

Parameter	Min.	Typ.	Max.	Unit
Pixel pitch		10		µm
Pixel architecture	Dual Tap Current Assisted Photonic Demodulator			
External Quantum Efficiency ¹ @ 850nm		51.0		%
External Quantum Efficiency ¹ @ 940nm		28.0		%
Pixel dark noise		83		e-
AC demodulation contrast ² @ 50MHz		85		%
AC demodulation contrast ² @ 100MHz		69		%
Single tap dark current	20	51	508	ke-/s
Single tap full well capacity	106	160		ke-
Single tap conversion gain		0.0106		DN/e-
Phase drift over temperature ³		0.046		deg/°C
Local PDNU ⁴			tbd	deg
Global PDNU ⁵			tbd	deg
Defective pixel ⁶			tbd	pixel
Microlense(s)	Yes			
Maximum CRA (chief ray angle)			30	°

Table 12: Pixel & Image Array Characteristics

Note¹: External quantum efficiency (EQE) can be calculated as $EQE_{\lambda} = \frac{RE_{\lambda}}{\lambda} \cdot \frac{h \cdot c}{e} \cdot FF = \frac{RE_{\lambda}}{\lambda} \cdot 1240 \cdot FF$

RE_{λ} = responsivity at wavelength (in A/W) c = speed of light in vacuum
 λ = the wavelength (in nm) e = elemental charge
 h = Planck's constant FF = fill factor (in %)

Note²: Detailed AC demodulation contrast data can be found in Figure 10.

Note³: Stability of the calculated phase (= distance) over temperature

Note⁴: Local PDNU (phase depth non uniformity) is a metric for the phase offset between 3x3 pixel blocks for a homogeneous flat field measurement

Note⁵: Global PDNU is similar to local PDNU but data is based on 10x10 pixel blocks

Note⁶: A defective pixel is defined as a pixel with low demodulation contrast or low responsivity compared to its neighbours

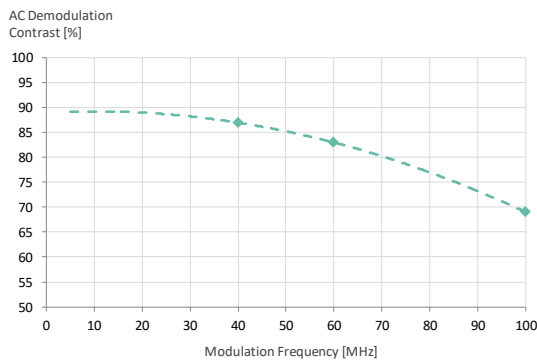

Figure 10: AC Demodulation Contrast in function of Modulation Frequency

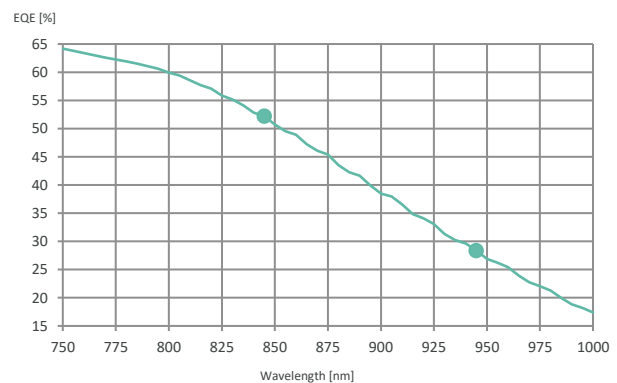

Figure 11: External Quantum Efficiency in function of Wavelength

4.3. CRA (Chief Ray Angle)

Image Height ¹ (%)	Image Height ¹ (mm)	CRA (°)
0	0.0	0
10	0.4	3.3
20	0.8	6.6
30	1.2	9.8
40	1.6	13
50	2.0	16.1
60	2.4	19.1
70	2.8	22.0
80	3.2	24.8
90	3.6	27.5
100	4.0	30

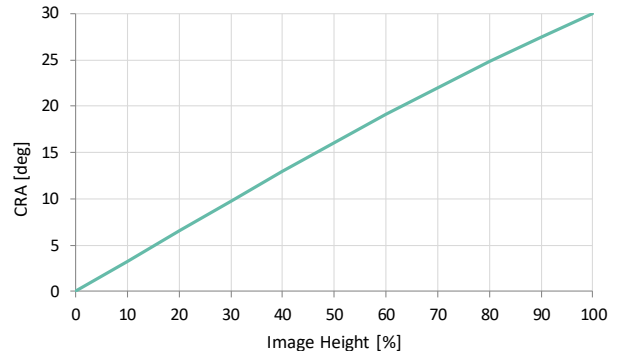

Figure 12: Image height versus CRA

Table 13: Image Height vs CRA

Note¹ : Image height is defined along the diagonal axis of the image array as shown below.

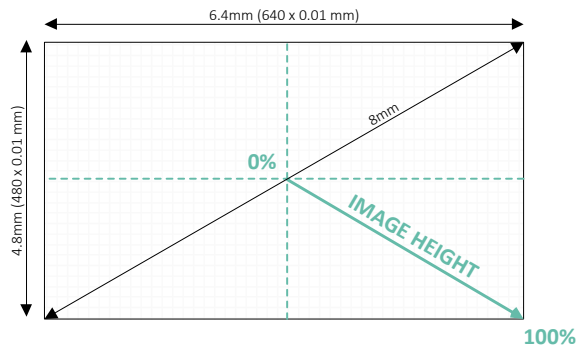

Figure 13: Image Height Definition

4.4. MTF (Modulation Transfer Function)

The modulation transfer function is an indication on the system response to different spatial frequencies. It tends to decrease with an increase in spatial frequency. A typical example is an out of focus lens, which has a low modulation factor for higher frequencies, resulting in an overall blur of the edges in the image.

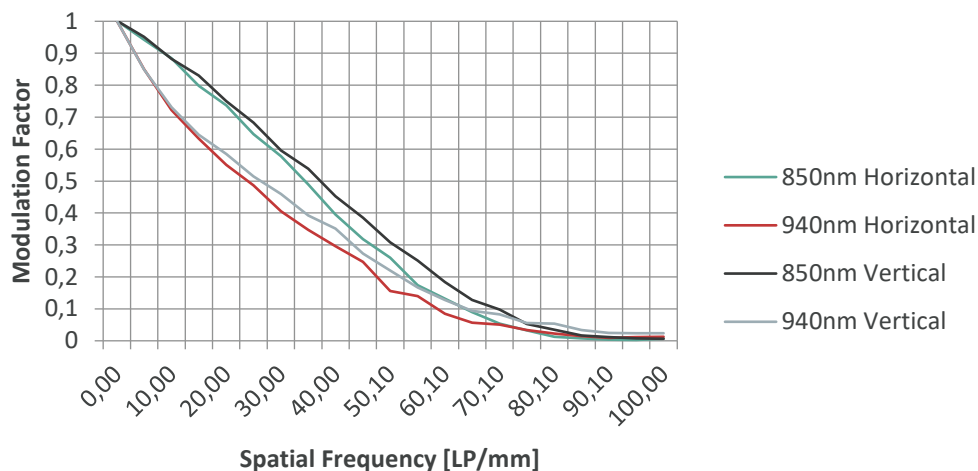

Figure 14: Modulation Transfer Function

The total system MTF is impacted by the image sensor and its optics. The shown data is considered the sensor only MTF, as it has been compensated for lens influences.

4.5. Application Lens Design Recommendations

When designing or selecting external optics to focus the light on the optical sensitive pixel area there are a few recommendations to take into account:

- To avoid pixel saturation under strong sunlight an optical bandpass filter is highly recommended. The spectral width of this filter depends on the type of illumination, LED or VCSEL, and should be as small as possible, taken into account the spectral drift over temperature.
- To reduce the illumination radiant intensity and to maximize the system efficiency the lens aperture should be as high as possible (= low F-number)
- The built-in microlenses require UV protection, most conveniently integrated into the lens, to avoid permanent deformation of the optics. UV exposure must be limited to **tbd** over lifetime.

5. Communication Interface(s)

MLX75027 uses one low speed bidirectional I2C interface for register control and one unidirectional high speed MIPI CSI2 serial video output interface.

5.1. I²C (Inter-Integrated Circuit)

This 2-wire serial communication protocol supports 16 bit register addresses and 8 bit data messages.

5.1.1. I²C Timing Sequence



- From master to slave
 - From slave to master
 - Direction depends on operation
- S = Start condition
 Sr = Repeated start condition
 P = Stop condition
 A = Acknowledge
 \bar{A} = Negative acknowledge
- R/W = read/write command
 0 : Write (master > slave)
 1 : Read (slave > master)

The data is transferred serially, MSB first in 8-bit units. After each data byte is transferred, A (Acknowledge) / \bar{A} (Negative acknowledge) is transferred. Data (SDA) is transferred at the clock (SCL) cycle. SDA can change only while SCL is low, so the SDA value must be held while SCL is high. The Start condition is defined by SDA changing from high to low while SCL is high. When the Stop condition is not generated in the previous communication phase and Start condition for the next communication is generated, that Start condition is recognized as a Repeated Start condition.

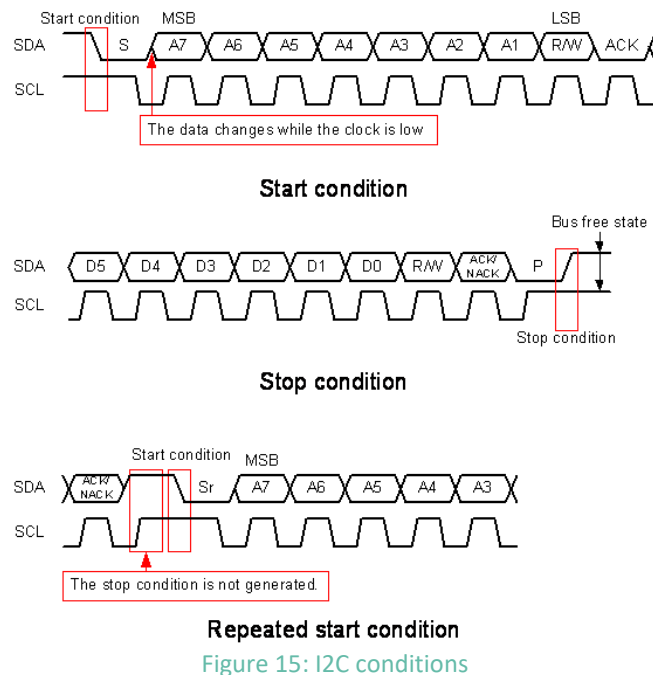

After transfer of each data byte, the Master or the sensor transmits an Acknowledge / Negative acknowledge and releases (does not drive) SDA. When a Negative acknowledge is generated, the Master must immediately generate the Stop Condition and end the communication.

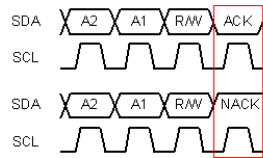

Acknowledge, Negative Acknowledge
Figure 16: I2C negative acknowledge

5.1.2. Single I²C Read

The sensor has an index function that indicates which address it is focusing on. When reading data, the Master must set the index value to the address to be read. For this purpose it performs a dummy write operation up to the register address. The upper level of the figure shows the sensor internal index value, and the lower level shows the SDA I/O data flow. The Master sets the sensor index value to M by designating the sensor slave address with a write request, then designating the address (M). Then, the Master generates the start condition. The Start Condition is generated without generating the Stop Condition, so it becomes the Repeated Start Condition. Next, when the Master sends the slave address with a read request, the sensor outputs an Acknowledge immediately followed by the address data from index M on SDA. After the Master receives the data, it generates a Negative Acknowledge and the Stop Condition to end the communication.

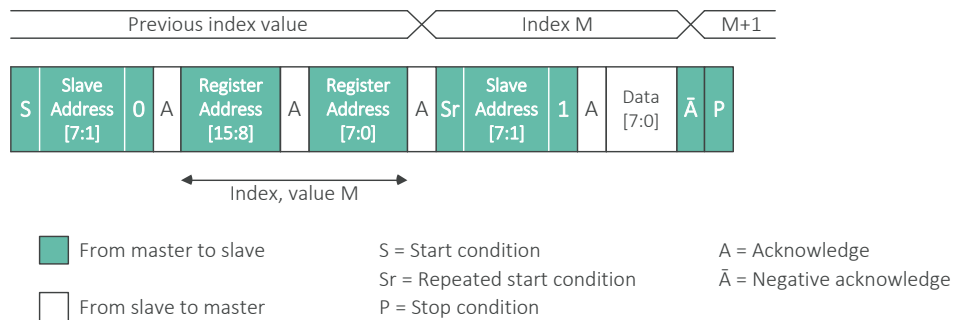

Note: It is possible to omit the Register Address [15:0] from the communication, in that case the sensor will simply read the value of register previously set to index M.

5.1.3. Sequential I²C Read

A sequential read of the data reads multiple registers sequentially without setting the register addresses individually. The Master must set the index value to the start of the addresses to be read. For this purpose, a dummy write operation includes the register address setting. The Master sets the sensor index value to M by designating the sensor slave address with a read request, then designating the address (M). Then, the Master generates the Repeated Start Condition. Next, when the Master sends the slave address with a read request, the sensor outputs an Acknowledge followed immediately by the data from index M on SDA. When the Master outputs an Acknowledge (instead of Negative acknowledge for a single I²C read) after it receives the data, the index value inside the sensor is incremented and the data at the next address is output on SDA. This allows the Master to read data sequentially. After reading the necessary data, the Master generates a Negative Acknowledge and the Stop Condition to end the communication.

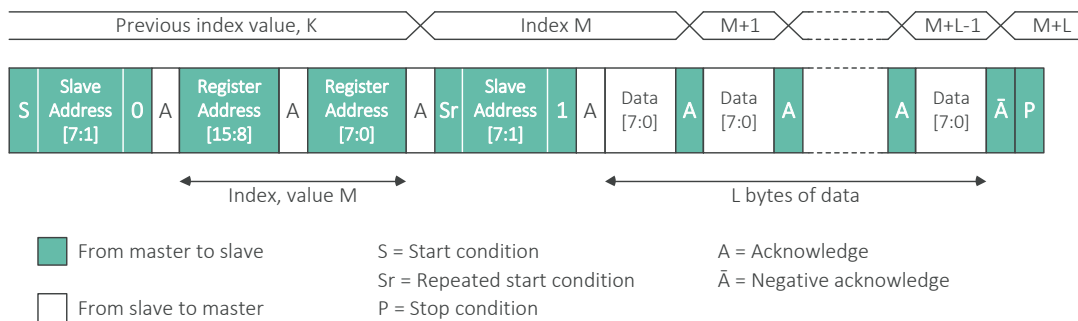

Note: It is possible to omit the Register Address [15:0] from the communication, in that case the sensor will simply read the values of the registers starting at the previously set index M.

5.1.4. Single I²C Write

The Master sets the sensor index value to M by designating the sensor slave address with a write request, and designating the register address (M). After that the Master can write the value in the designated register by transmitting the data to be written. After writing the necessary data, the Master generates the Stop Condition to end the communication.

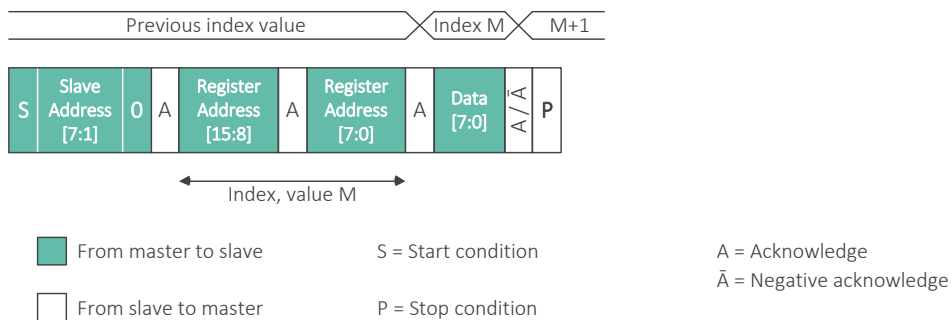

5.1.5. Sequential I²C Write

The Master can write a value to register address M by designating the sensor slave address with a write request, designating the address (M), and then transmitting the data to be written. After the sensor receives the write data, it outputs an Acknowledge and at the same time increments the register address, so the Master can write to the next address simply by continuing to transmit data. After the Master writes the necessary number of bytes, it generates the Stop Condition to end the communication.

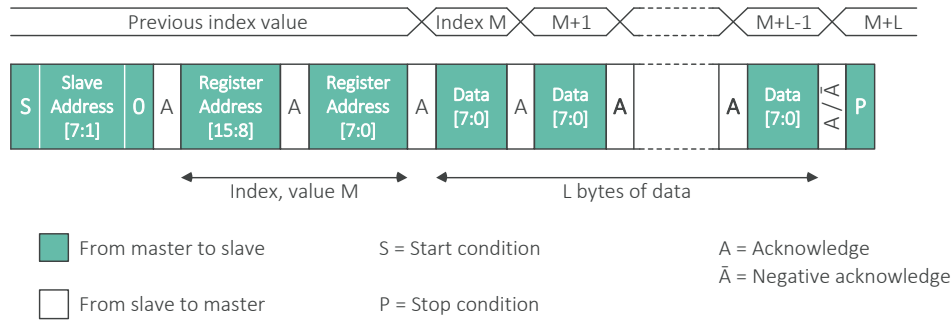

5.1.6. I²C Slave Address

For communication with MLX75027 via I²C the user has to choose between two different 7bit slave addresses. Selection can be done by the external SLASEL pin, by connecting it either to VDDD (high) or DGND (low).

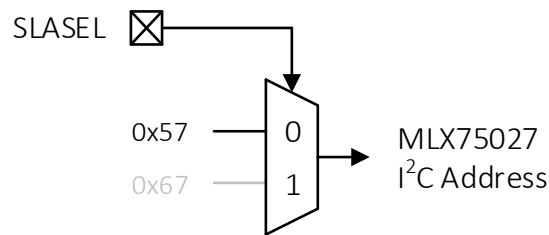

Important Note : I²C slave address 0x67 is not programmed on engineering samples. To avoid bring-up issues, please connect SLASEL to GND.

5.2. MIPI Alliance CSI-2 Description

This section describes a limited set of CSI-2 functionality needed to understand operation of MLX75027. For a full interface description, please refer to MIPI Alliance CSI-2 Specification version 1.20.

5.2.1. Packet Structure

CSI-2 uses a byte oriented, packet based protocol that supports the transport of arbitrary data using *Short Package (SP)* and *Long Package (LP)* formats. A 32bit *Short Packet* does not have any data or a *Package Footer (PF)*. Only FS (*Frame Start*) or FE (*Frame End*) indicators use *Short Packets*.

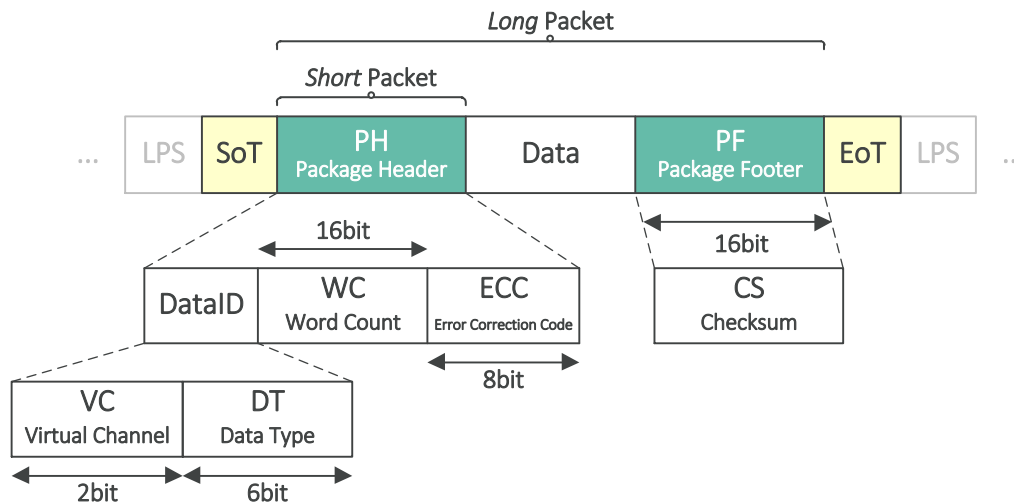

Figure 17: Package structure

Every packet starts with a SoT (start of transmission) sequence preceded by a LPS (low power state). An EoT (end of transmission) sequence followed by the low power state indicates the end of a packet.

Each byte is transmitted with the least significant bit first, in case of multi-byte data (such as WC or CS) the least significant byte will be transmitted first, unless otherwise specified by the data format.

VC: The virtual channel identifier provides separate channels for different data flows that are interleaved in the data stream (lane indicator). The default value is 0.

DT: The data type value specifies the format and content of the data payload.
 0x00 = FS (Frame Start) 0x12 = Embedded data (or MetaData)
 0x01 = FE (Frame End) 0x2C = RAW12 pixel data

WC: For *short* packets the word count field is considered a 16bit data field, representing the Frame Count [7:0]. After each FS (Frame Start) transmission, the Frame Count will be increased by 1. For *long* packets word count specifies the total amount of bytes between the end of PH and start of PF.

ECC: The error correction code used is a 7+1bits Hamming-modified code. This code allows single-bit errors to be corrected and 2-bit errors to be detected in the DataID and WC fields but is not capable of doing both simultaneously.

CS: To detect possible errors in the data transmission, a checksum is calculated over each data packet. The checksum is a 16bit CRC generated by this polynomial:

$$CRC = x^{16} + x^{12} + x^5 + x^0$$

When WC is zero, CS will be 0xFFFF

5.2.2. Data Format RAW12

Each DepthSense® pixel is represented by 12bit data packed like 8bit data.

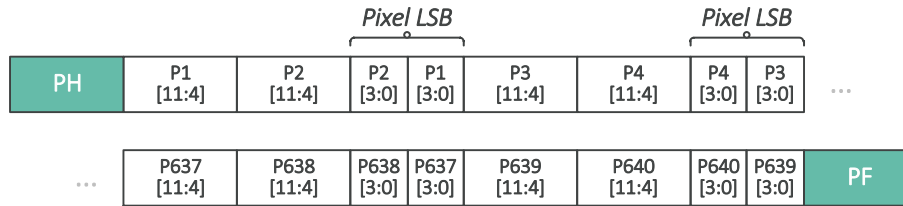

Figure 18: Example of pixel ordering for one full line transmission

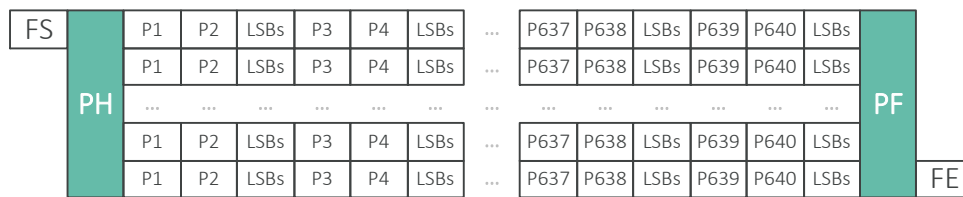

Figure 19: Example of pixel ordering for one full frame transmission

Table 14 specifies the minimum packet data size constraints. The total length of each packet must be a multiple of the values in this table.

# Pixels	# Bytes	# Bits
2	3	24

Table 14: RAW12 Packet size constraints

5.2.2.1. Data Format in 4 Lane MIPI Configuration

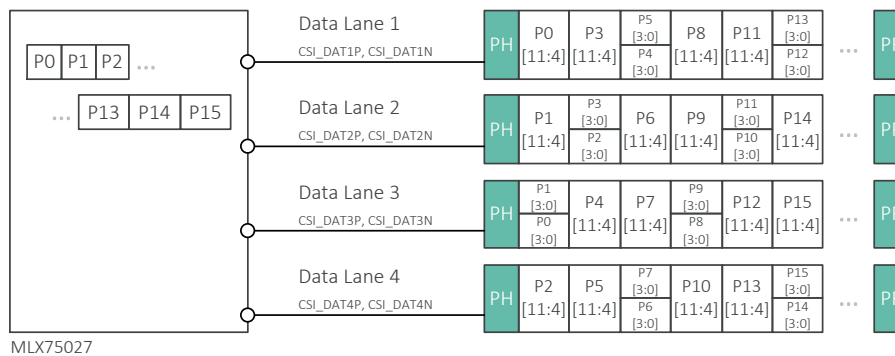

MLX75027

Figure 20: Pixel Data Format in 4 Lane Data Configuration

5.2.2.2. Data Format in 2 Lane MIPI Configuration

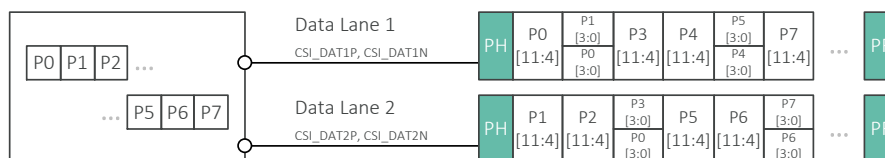

MLX75027

Figure 21: Pixel Data Format in 2 Lane Data Configuration

6. Start-up Sequence

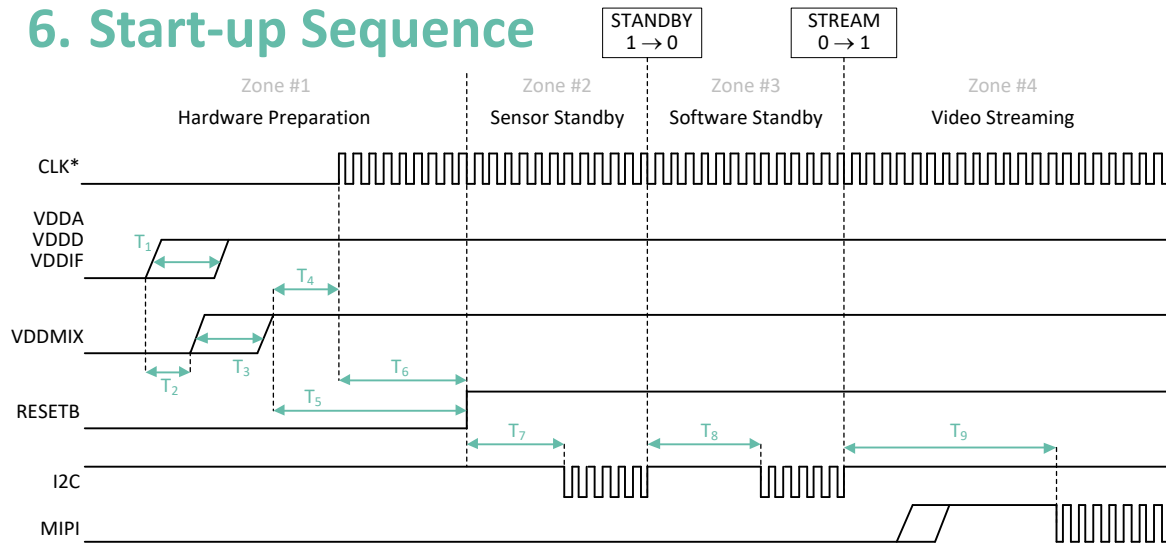

Figure 22: Sensor start-up sequence

* Availability of CLK signal before voltage domain bring up is also accepted

0x1000	7	6	5	4	3	2	1	0
R/W	-	-	-	-	-	-	-	STANDBY

Default Value 0x01

0x1001	7	6	5	4	3	2	1	0
R/W	-	-	-	-	-	-	-	STREAM

Default Value 0x00

Zone #1 : Hardware Preparation : Time to supply the clock, the required voltage domains and initialize the RESETB level. RESETB is a digital control signal, the μ C keeps it low until all requirements of zone 2 have been fulfilled.

Zone #2 : Sensor Standby : Time to define input clock settings, as shown in section 0

Zone #3 : Software Standby : In this period it's advised to write all frame acquisition parameters (like integration time, modulation frequency & others) before video streaming.

Zone #4 : Video Streaming : Frame capture is active and MIPI output data is available. Register changes during active frame acquisition will be applied on the next frame.

Description	Symbol	Min.	Max.	Unit
Time between VDDA OFF and VDDA ON		108		
Time between VDDD OFF and VDDD ON	T_1	48		μ s
Time between VDDIF OFF and VDDIF ON		72		
Time between VDDA, VDDD, VDDIF ON and VDDMIX ON	T_2	0		μ s
Time between VDDMIX OFF and VDDMIX ON	T_3	48		μ s
Time between VDDMIX ON and CLK ON	T_4	0		μ s
Time between VDDA, VDDD, VDDIF, VDDMIX, CLK ON and RESETB OFF	T_5	100		μ s
Time between CLK ON and RESETB OFF	T_6	0		μ s
Time between RESETB and first I2C command	T_7	100		μ s
Time between STANDBY OFF and STREAM ON	T_8	12		ms
Time between STREAM ON and first video data	T_9		$2.8 + T_{int}$	ms

Table 15: Startup timing

6.1. Initialization Process

MLX75027 requires a SW initialization on each start-up/reset and/or power cycle.

Operating Mode	Register Address	Register Value	Comment	
Hardware Preparation			End <i>Hardware Preparation</i> by pulling RESETB high	
Sensor Standby	0x1006	0x08	Fixed Input Clock Settings	
	0x1007	0x00		
	0x1040	0x00		
	0x1041	0x96		
	0x1042	0x01		
	0x1043	0x00		
	0x1044	0x00		
	0x1046	0x01		
	0x104A	0x01		
	0x1000	0x00	Change from <i>Sensor Standby</i> to <i>Software Standby</i> by changing register 0x1000 (default value 0x01) to value 0x00	
Software Standby	313 initialization registers		Program the FULL initialization map from section 6.2	
	Add here relevant application registers that require an update of their reset value ▼ (examples listed below) ▼			
	0x100C ... 0x1071	custom	Configure video output interface (see section 7.1)	
	0x2020 0x2100	custom	Configure TRIGGER or CONTINUOUS mode (see section 7.2)	
	0x2F05	custom		
	0x2F06	custom		
	0x2F07	custom		
	0x3071	custom		
	0x0828	custom	Configure Data Output Mode (see section 7.3)	
	0x0800 0x5267	custom	Configure HMAX related settings (see section 7.4)	
	0x21BE ... 0x104B	custom	Configure Modulation Frequency (see section 7.7)	
	0x21E8	custom	Configure number of phases (see section 7.11)	
	0x2120 ... 0x213F	custom	Configure Integration Time per phase (see section 0)	
	0x21B4 ... 0x21B7	custom	Configure PHASE_SHIFT per phase (see section 0)	
	▲ End of relevant application registers ▲			
	0x1001	0x01	Enter <i>Video Streaming</i> by changing register 0x1001 (value 0x00) to value 0x01	
	Video Streaming			Application is now running

Table 16: Initialisation process

6.2. Initialization Register Map

This set of initialization registers are listed in order of priority (top > bottom, left > right, next page) :

Register Address	Register Value	Register Address	Register Value	Register Address	Register Value	Register Address	Register Value
0x10D2	0x00	0x413C	0x04	0x478F	0x00	0x4878	0x00
0x10D3	0x10	0x4146	0x01	0x4792	0x00	0x4879	0xA0
0x1448	0x06	0x4147	0x01	0x4793	0x00	0x487A	0x00
0x1449	0x40	0x4148	0x01	0x4796	0x00	0x487B	0xA1
0x144A	0x06	0x4149	0x01	0x4797	0x00	0x48BC	0x00
0x144B	0x40	0x414A	0x01	0x479A	0x00	0x48BD	0xA0
0x144C	0x06	0x414B	0x01	0x479B	0x00	0x48BE	0x00
0x144D	0x40	0x414C	0x01	0x479C	0x1F	0x48BF	0xA1
0x144E	0x06	0x414D	0x01	0x479D	0xFF	0x4954	0x00
0x144F	0x40	0x4158	0x01	0x479E	0x00	0x4955	0xA0
0x1450	0x06	0x4159	0x01	0x479F	0x00	0x4956	0x00
0x1451	0x40	0x415A	0x01	0x47A2	0x00	0x4957	0xA1
0x1452	0x06	0x415B	0x01	0x47A3	0x00	0x4984	0x00
0x1453	0x40	0x415C	0x01	0x47A6	0x00	0x4985	0xA0
0x1454	0x06	0x415D	0x01	0x47A7	0x00	0x4986	0x00
0x1455	0x40	0x415E	0x01	0x47AA	0x00	0x4987	0xA1
0x1456	0x06	0x415F	0x01	0x47AB	0x00	0x49B8	0x00
0x1457	0x40	0x4590	0x00	0x47AC	0x1F	0x49B9	0x78
0x21C4	0x00	0x4591	0x2E	0x47AD	0xFF	0x49C2	0x00
0x2202	0x00	0x4684	0x00	0x47AE	0x00	0x49C3	0x3C
0x2203	0x1E	0x4685	0xA0	0x47AF	0x00	0x49C8	0x00
0x2C08	0x01	0x4686	0x00	0x47B2	0x00	0x49C9	0x76
0x2C0C	0x51	0x4687	0xA1	0x47B3	0x00	0x49D2	0x00
0x2C0D	0x00	0x471E	0x07	0x47B6	0x00	0x49D3	0x3F
0x3C2B	0x1B	0x471F	0xC9	0x47B7	0x00	0x49DC	0x00
0x400E	0x01	0x473A	0x07	0x47BA	0x00	0x49DD	0xA0
0x400F	0x81	0x473B	0xC9	0x47BB	0x00	0x49DE	0x00
0x40D1	0x00	0x4770	0x00	0x47BC	0x1F	0x49DF	0xA1
0x40D2	0x00	0x4771	0x00	0x47BD	0xFF	0x49EE	0x00
0x40D3	0x00	0x4772	0x1F	0x47BE	0x00	0x49EF	0x78
0x40DB	0x3F	0x4773	0xFF	0x47BF	0x00	0x49F8	0x00
0x40DE	0x40	0x4778	0x06	0x47C2	0x00	0x49F9	0x3C
0x40DF	0x01	0x4779	0xA4	0x47C3	0x00	0x49FE	0x00
0x412C	0x00	0x477A	0x07	0x47C6	0x00	0x49FF	0x78
0x4134	0x04	0x477B	0xAE	0x47C7	0x00	0x4A04	0x00
0x4135	0x04	0x477D	0xD6	0x47CA	0x00	0x4A05	0x3C
0x4136	0x04	0x4788	0x06	0x47CB	0x00	0x4A0A	0x00
0x4137	0x04	0x4789	0xA4	0x4834	0x00	0x4A0B	0x76
0x4138	0x04	0x478C	0x1F	0x4835	0xA0	0x4A10	0x00
0x4139	0x04	0x478D	0xFF	0x4836	0x00	0x4A11	0x3F
0x413A	0x04	0x478E	0x00	0x4837	0xA1	0x4A1A	0x00
0x413B	0x04						

Table 17: Initialization Map Part I

Register Address	Register Value	Register Address	Register Value	Register Address	Register Value	Register Address	Register Value
0x4A1B	0xA0	0x4BC6	0x00	0x4D1B	0x49	0x4E39	0x07
0x4A1C	0x00	0x4BC7	0x1A	0x4D1E	0x07	0x4E7B	0x64
0x4A1D	0xA1	0x4BCE	0x00	0x4D1F	0xC9	0x4E8E	0x0E
0x4A1E	0x00	0x4BCF	0x1A	0x4D2A	0x07	0x4E9A	0x00
0x4A1F	0x78	0x4BEE	0x00	0x4D2B	0xC9	0x4E9C	0x01
0x4A28	0x00	0x4BEF	0xA0	0x4D4A	0x07	0x4EA0	0x01
0x4A29	0x3C	0x4BF0	0x00	0x4D4B	0xC9	0x4EA1	0x03
0x4A4A	0x00	0x4BF1	0xA1	0x4D50	0x06	0x4EA5	0x00
0x4A4B	0xA0	0x4BF6	0x00	0x4D51	0x9B	0x4EA7	0x00
0x4A4C	0x00	0x4BF7	0x1A	0x4D52	0x07	0x4F05	0x04
0x4A4D	0xA1	0x4C00	0x00	0x4D53	0xAE	0x4F0D	0x04
0x4A7A	0x00	0x4C01	0x1A	0x4D56	0x07	0x4F15	0x04
0x4A7B	0xA0	0x4C58	0x00	0x4D57	0xC9	0x4F19	0x01
0x4A7C	0x00	0x4C59	0xA0	0x4D5C	0x06	0x4F20	0x01
0x4A7D	0xA1	0x4C5A	0x00	0x4D5D	0x98	0x4F66	0x0F
0x4AEE	0x00	0x4C5B	0xA1	0x4D5E	0x07	0x500F	0x01
0x4AEF	0xA0	0x4C6E	0x00	0x4D5F	0xB1	0x5224	0x00
0x4AF0	0x00	0x4C6F	0xA0	0x4D70	0x06	0x5225	0x2F
0x4AF1	0xA1	0x4C70	0x00	0x4D71	0xA4	0x5226	0x00
0x4B2E	0x00	0x4C71	0xA1	0x4D72	0x07	0x5227	0x1E
0x4B2F	0xA0	0x4C7A	0x01	0x4D73	0x49	0x5230	0x00
0x4B30	0x00	0x4C7B	0x35	0x4D78	0x06	0x5231	0x19
0x4B31	0xA1	0x4CF2	0x07	0x4D79	0xA4	0x5244	0x00
0x4B5A	0x00	0x4CF3	0xC9	0x4D7A	0x07	0x5245	0x07
0x4B5B	0xA0	0x4CF8	0x06	0x4D7B	0xAE	0x5252	0x07
0x4B5C	0x00	0x4CF9	0x9B	0x4D7C	0x1F	0x5253	0x08
0x4B5D	0xA1	0x4CFA	0x07	0x4D7D	0xFF	0x5254	0x07
0x4B86	0x00	0x4CFB	0xAE	0x4D7E	0x1F	0x5255	0xB4
0x4B87	0xA0	0x4CFE	0x07	0x4D7F	0xFF	0x5271	0x00
0x4B88	0x00	0x4CFF	0xC9	0x4D80	0x06	0x5272	0x04
0x4B89	0xA1	0x4D04	0x06	0x4D81	0xA4	0x5273	0x2E
0x4B9E	0x00	0x4D05	0x98	0x4D82	0x07	0x5281	0x00
0x4B9F	0x1A	0x4D06	0x07	0x4D83	0xAE	0x5282	0x04
0x4BAE	0x00	0x4D07	0xB1	0x4D84	0x1F	0x5283	0x2E
0x4BAF	0x1A	0x4D18	0x06	0x4D85	0xFF	0x5285	0x00
0x4BB6	0x00	0x4D19	0xA4	0x4D86	0x1F	0x5286	0x00
0x4BB7	0x1A	0x4D1A	0x07	0x4D87	0xFF	0x5287	0x5D

Table 18: Initialization Map Part II

7. Register Settings

7.1. Video Output Configuration

Correct data communication settings have to be programmed in *Software Standby* mode. This is part of the initialization map as described in section 6.

0x1010	7	6	5	4	3	2	1	0
R/W	-	-	-	-	-	-	DATA_LANE_CONFIG	1

Reset Value 0x03

- 1b0: 2 data lane configuration
- 1b1: 4 data lane configuration (= default)

Registers listed in Table 19 need to be updated to support data transmission speeds of 300, 600, 704, 800 & 960 Mbps.

# Data Lanes	Communication Speed	0x100C	0x100D	0x1016	0x1017	0x1045	0x1047	0x1060	0x1071
2	300 Mbps	0x02	0x58	0x09	0x99	0x4B	0x02	0x01	0x0C
	600 Mbps	0x04	0xB0	0x04	0xCC	0x4B	0x02	0x00	0x06
	704 Mbps	0x05	0x80	0x04	0x17	0x58	0x02	0x00	0x06
	800 Mbps	0x06	0x40	0x03	0x99	0x64	0x02	0x00	0x06
	960 Mbps	0x07	0x80	0x03	0x00	0x78	0x02	0x00	0x06
4	300 Mbps	0x04	0xB0	0x09	0x99	0x4B	0x02	0x01	0x0C
	600 Mbps	0x09	0x60	0x04	0xCC	0x4B	0x02	0x00	0x06
	704 Mbps	0x0B	0x00	0x04	0x17	0x58	0x02	0x00	0x06
	800 Mbps	0x0C	0x80	0x03	0x99	0x64	0x02	0x00	0x06
	960 Mbps	0x0F	0x00	0x03	0x00	0x78	0x00	0x00	0x06

Table 19: Data Rate Configuration Settings

0x1C40	7	6	5	4	3	2	1	0
R/W	-	-	-	-	-	-	-	CLK_OFF

Reset Value 0x01

The clock enters a low power state (LPS) between the different data frames (CLK_OFF=1) by default. It is possible to enable to clock continuously (stay in HS mode during frame blanking) via parameter CLK_OFF=0 for compatibility with some microcontrollers.

7.2. Modes of Operation

MLX75027 features three modes of operation: hardware triggered, software triggered or continuous mode. It's mandatory to change the operating mode during *Software Standby* as described in section 6.

Register Address	Register Value		
	HARDWARE TRIGGERED MODE (by external pin K11)	SOFTWARE TRIGGERED MODE	CONTINUOUS MODE (trigger will occur internally at each FRAME_TIME interval, see section 7.10)
0x2020	0x00	0x01	0x01
0x2100	0x00	0x01 (bit[0] is a self-clearing bit that acts as trigger when set to 0x1 via I2C)	0x08
0x2F05	0x07	0x01	0x01
0x2F06	0x00	0x09	0x09
0x2F07	0x00	0x7A	0x7A
0x3071	0x03	0x00	0x00

Table 20: Modes of operation

In hardware triggered mode the TRIGGER pin accepts active low pulses to start a new frame. In software triggered mode the trigger is set by writing a 0x01 to the 0x2100 register.

Triggers send during an active frame acquisition will be ignored as indicated here:

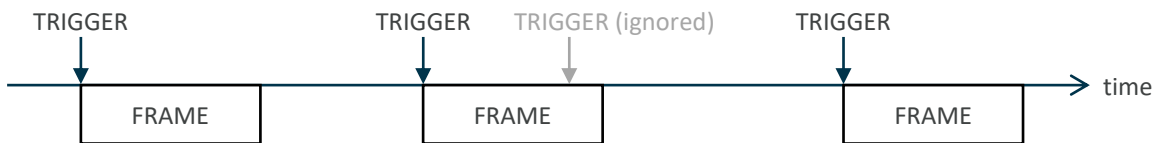

7.3. Data Output Modes

One DepthSense™ pixel has two outputs, known as tap A and tap B, each in counterphase (180° shifted) of one another. To reduce the calculation time from raw data to distance information MLX75027 supports output modes that already combine the information from both taps, either as sum or as difference.

For Time-of-Flight experts the raw information of both taps is also available either in Raw A, Raw B or Raw A & B output modes. Regular users should use the default output mode A-B since this directly reduces the required processing power to calculate the distance map on the microcontroller. More information on the distance calculation is available section 9.

The data output mode cannot change during *video streaming*, it is mandatory to change the data output mode during *Software Standby* as described in section 6.

0x0828	7	6	5	4	3	2	1	0
R/W	-	-	-	-	-	OUTPUT_MODE		

Reset Value 0x00

- 3b000: Mode A-B (=12bit signed data)
 - 3b001: Mode A+B (=12bit unsigned data)
 - 3b010: Mode Raw A
 - 3b011: Mode Raw B
 - 3b100: Mode Raw A & B
- (other values are prohibited)

A full VGA frame in Mode A-B looks like Figure 23. The default horizontal resolution is 640 pixels, except in Mode Raw & B where two values per pixel (=1280) will be read out.

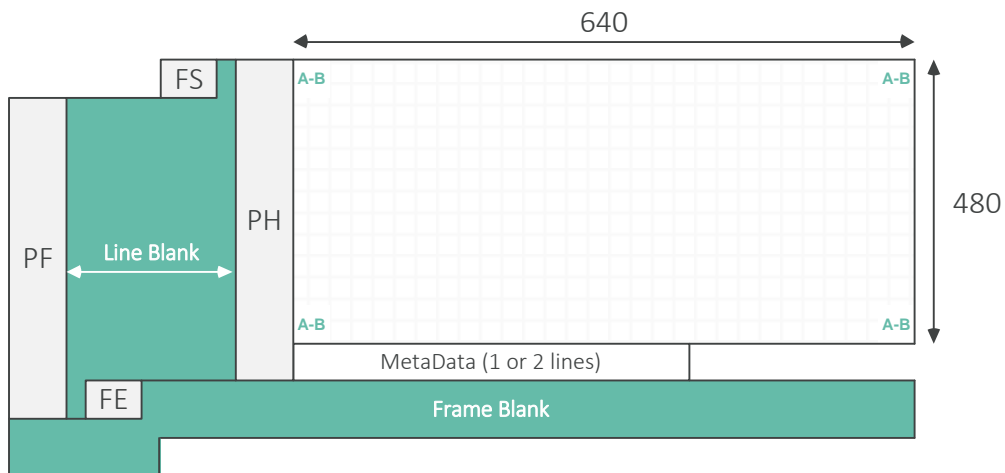

Figure 23: A single MIPI Frame

7.4. HMAX & Frame Read-Out Time

The HMAX parameter represents a number of internal clock pulses needed for one data row transmission. This time includes the communication protocol overhead (like data headers and power stage transitions), but also the actual data payload. It is a fixed value dependent on the data output configuration (section 7.1) and the output mode (section 7.3), it cannot be modified during *video streaming*. Other configuration parameters, expressed in function of HMAX, need to be modified accordingly. (see section 7.4.1, 7.4.2 and 7.4.3)

0x0800	7	6	5	4	3	2	1	0
R/W	-	-	HMAX [13:8]					

Reset Value 0x02

0x0801	7	6	5	4	3	2	1	0
R/W	HMAX [7:0]							

Reset Value 0xB6

The time needed to read out a single phase is highly linked with the HMAX parameter, the corresponding read out time can be found in the table below.

Operation Mode	DATA_LANE_CONFIG	Communication Speed (Mbps)	HMAX	Single Phase Readout Time ¹ (ms)
Mode A-B Mode A+B Mode Raw A Mode Raw B	2	300	0x0E60	7.85
		600	0x0744	3.97
		704	0x0636	3.52
		800	0x057A	2.99
		960	0x0514	2.77
	4	300	0x0860	4.57
		600	0x0444	2.33
		704	0x03A8	2.00
		800	0x033A	1.76
		960	0x02B6	1.48
Mode Raw A&B	2	300	0x1CC0	15.70
		600	0x0E88	7.94
		704	0x0C6C	6.78
		800	0x0AF4	5.98
		960	0x0A28	5.54
	4	300	0x0E60	7.85
		600	0x0744	3.97
		704	0x0636	3.39
		800	0x057A	2.99
		960	0x0514	2.77

Table 21: HMAX

Note¹: Continuous wave time of flight typically uses 4 phases/quads to calculate a single distance image. These four snapshots are taken sequentially in time, which leads to the fact that any time delay between these images can contribute to motion blur, depending on the speed of the detected object. The time between the images is dominated by the sensor read out time. In order to minimize motion artefacts the read out time should be chosen as short as possible. The timing listed in this table are maximum values (in millisecond) for a single phase at full resolution (640x480 pixels). Reducing the image size (with ROI or binning) has a direct and positive impact on the read out time.

Important : Different timing related registers are closely linked to the HMAX parameter. It's the user responsibility to update PLLSETUP, PIXRST & RANDNM0 each time HMAX value is adjusted.

7.4.1. PLLSETUP



PLLSETUP is the time required for the *Timing Generator* block (see section 2) to settle before each frame and it can be calculated as $\text{FLOOR}\left(\frac{503 \cdot 120}{\text{HMAX}} + 8\right)$

7.4.2. PIXRST

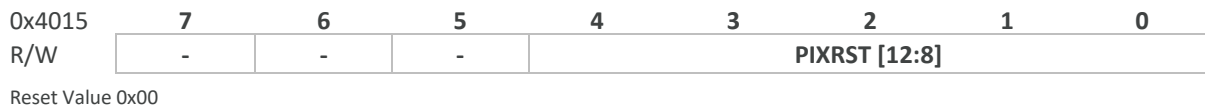

PIXRST is the pixel reset time before each integration time. It can be calculated as $\text{FLOOR}\left(\frac{50 \cdot 120}{\text{HMAX}}\right)$. If Px_PRETIME is used the register value should be calculated as described in section 7.12 and the register refers to not only pixel reset time but also Px_PRETIME.

7.4.3. RANDNM0



RANDNM0 can be calculated as $\text{HMAX} \cdot \text{PIXRST} - \text{RANDNM7} - 2098$
(RANDNM7 = 1070 with premix disabled, more information can be found in section 7.12)

7.5. PARAM_HOLD

Each frame consists of multiple configuration parameters, controlled via a *slow* I²C interface. To avoid frame to frame data corruption when changing more than one parameter (like to modulation frequency or integration time) the user can enable *shadow* registers that temporarily store the updated values and apply all changes at once when the PARAM_HOLD bit is released.

0x0102	7	6	5	4	3	2	1	0
R/W	-	-	-	-	-	-	-	PARAM_HOLD

Reset Value 0x00

- 1b0: disable the shadow registers and update all registers at next TRIGGER pulse
- 1b1: enable the shadow registers

It is strongly recommended to use PARAM_HOLD for any register changes during video streaming.

7.6. USER_ID Register

A user programmable register, address 0x0824, will be read out in the first metadata line. This register, for example, can be used as an identifier for customer defined register maps. It is the user responsibility to program the USER_ID register, together with other register changes, during a single PARAM_HOLD period and after each phase it can be traced back which settings were used.

0x0824	7	6	5	4	3	2	1	0
R/W	USER_ID							

Reset Value 0x00

7.7. Modulation Frequency

The modulation frequency can be set for each frame between 4 and 100 MHz in steps of 1 MHz. Changing this frequency is possible during data streaming by changing the registers listed below. When updating the modulation frequency it's advised to use PARAM_HOLD like explained in section 0.

Changing the modulation frequency requires a set of five register values to be updated consecutively.

Register Address	Modulation Frequency					
	[100-75] MHz	[74-51] MHz	[9-5] MHz	4 MHz		
	[50-38] MHz	[37-21] MHz				
	[20-19] MHz	[18-10] MHz				
0x21BE	R/W	DIVSELPRE	0x00	0x01	0x02	0x03

Register Address	Modulation Frequency				
	[100-51] MHz	[50-21] MHz	[20-4] MHz		
	0x21BF	R/W	DIVSEL	0x00	0x01

0x1048	7	6	5	4	3	2	1	0
R/W	-	-	-	-	-	FMOD [10:8]		

Reset Value 0x00

0x1049	7	6	5	4	3	2	1	0
R/W	FMOD [7:0]							

Reset Value 0x50

FMOD[10:0] value is calculated as $2^{DIVSELPRE+DIVSEL} \cdot \text{Modulation Frequency}$

Example FMOD values:

- Modulation Frequency 100 MHz > FMOD = 100 = 0x64
- Modulation Frequency 80 MHz > FMOD = 80 = 0x50
- Modulation Frequency 40 MHz > FMOD = 80 = 0x50
- Modulation Frequency 20 MHz > FMOD = 80 = 0x50

Register Address		$500 \leq \text{FMOD} \cdot 8 < 900$	$900 \leq \text{FMOD} \cdot 8 \leq 1200$
0x104B	R/W	0x02	0x00

7.8. Frame Structure & Frame Rate

To reconstruct a 3D point cloud or a distance image based on indirect Time of Flight technology the sensor usually captures the phase interval for at least four sequential measurements, each called a phase. Each frame (or distance frame) can have up to eight individual phases configured (see section 7.11).

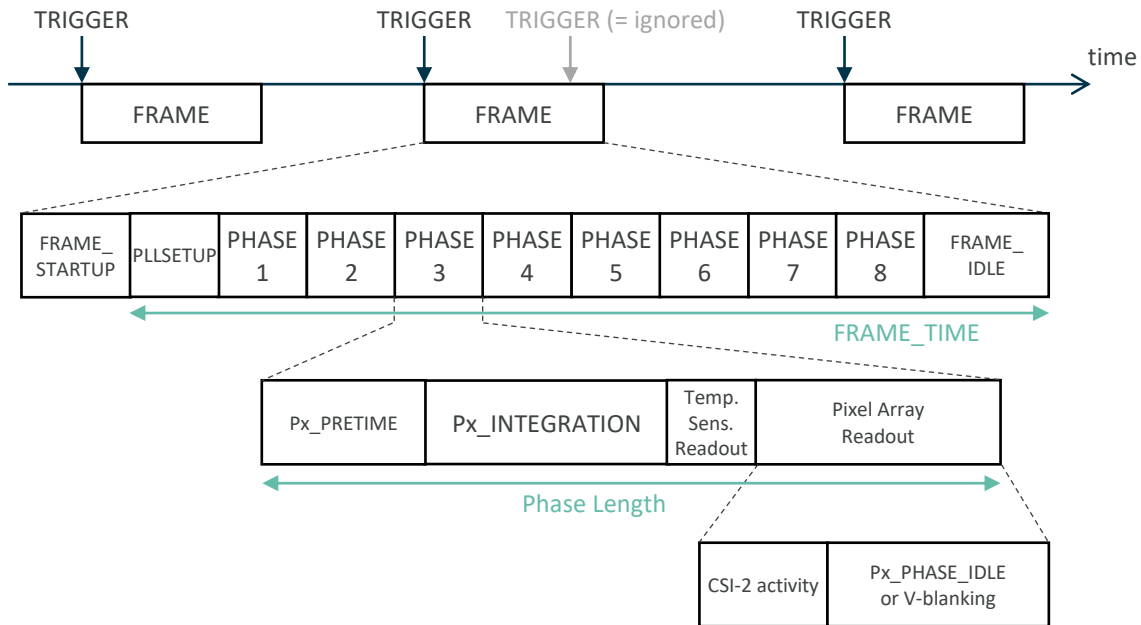

In continuous operating mode the system frame rate can be calculated as $\frac{1\,000\,000}{\text{Frame length (in } \mu\text{s)}}$

- Frame length (in μs) = $\frac{\text{FRAME_STARTUP} \cdot \text{HMAX}}{120} + 500 + \text{FRAME_TIME}$ (in μs) (eq.1)

- FRAME_TIME (in μs) = $\text{PHASE_COUNT} \cdot \text{Phase length}$ (in μs) (eq.2)

or

$$\text{FRAME_TIME (in } \mu\text{s)} = \frac{\text{FRAME_TIME} \cdot \text{HMAX}}{120} \quad (\text{only if an optional wait time is defined})$$

- Phase length (in μs) = $\frac{(\text{Px_PRETIME} + 256 + \text{Px_PHASE_IDLE} + \text{Px_INTEGRATION}) \cdot \text{HMAX}}{120}$ (eq.3)

In software or hardware triggered mode the frame rate is controlled by the microcontroller.

7.9. FRAME_STARTUP

The frame start up time is the time between a TRIGGER pulse and the start of the first phase acquisition. It can be used to synchronize multiple TOF systems and avoid optical interference.



Reset Value 0x00



Reset Value 0x00

The register value can be calculated as $\frac{\text{start up time (in } \mu\text{s)} \cdot 120}{\text{HMAX}}$

7.10. FRAME_TIME

The minimum length of a frame is dominated by the individual phase configurations. Programming a FRAME_TIME longer than the minimum time needed to capture all phases adds an additional wait time. This is convenient to achieve a fixed distance frame rate in continuous operating mode.

Register Address		Register Name	Default Value
0x2108	R/W	FRAME_TIME [31:24]	0x00
0x2109	R/W	FRAME_TIME [23:16]	0x00
0x210A	R/W	FRAME_TIME [15:8]	0x00
0x210B	R/W	FRAME_TIME [7:0]	0x00

Table 22: Frame time

The register value can be calculated as $\frac{\text{Frame Time (in } \mu\text{s)} \cdot 120}{\text{HMAX}}$

7.11. PHASE_COUNT

It is possible to define up to eight raw phases in a single frame for more complex acquisition schemes. The amount of phases inside a frame has to be programmed into PHASE_COUNT.



Reset Value 0x04

- 4b0001: Phase 1 enabled
 - 4b0010: Phase 1 - 2 enabled
 - 4b0011: Phase 1 - 3 enabled
 - 4b0100: Phase 1 - 4 enabled
 - 4b0101: Phase 1 - 5 enabled
 - 4b0110: Phase 1 - 6 enabled
 - 4b0111: Phase 1 - 7 enabled
 - 4b1000: Phase 1 - 8 enabled
- (other values are prohibited)

7.12. Px_PREHEAT, Px_PREMIX, Px_PRETIME

It is important that the illumination signal per phase is constant because any inconsistency across the different raw phases will lead to a distance measurement error. Spikes, visible in the optical illumination signal, due to temperature effects in the first microseconds of an integration period can cause such non constant behaviour. This can be avoided by preheating the illumination signal per phase, known as Px_PREHEAT and it can be enabled or disabled for each of the phases individually.

0x21C0	7	6	5	4	3	2	1	0
R/W	P8_ PREHEAT	P7_ PREHEAT	P6_ PREHEAT	P5_ PREHEAT	P4_ PREHEAT	P3_ PREHEAT	P2_ PREHEAT	P1_ PREHEAT

Reset Value 0x00

- 1b0: preheat off
- 1b1: preheat on

Although the measurement error is small on application level, similar effects can arise from the pixel/sensor side, for that reason it is also possible to enable a Px_PREMIX time. This is the time the sensor will start integrating before the illumination control signal is enabled. Please note that during this time light will already be accumulated which can lead to faster pixel saturation during integration time. It is advised to keep Px_PREMIX disabled.

0x21C2	7	6	5	4	3	2	1	0
R/W	P8_ PREMIX	P7_ PREMIX	P6_ PREMIX	P5_ PREMIX	P4_ PREMIX	P3_ PREMIX	P2_ PREMIX	P1_ PREMIX

Reset Value 0x00

- 1b0: premixing off
- 1b1: premixing on

Both PREHEAT and PREMIX use the same timing. The register linked incorporates also PIXRST, thus if no PREHEAT / PREMIX is used the register amounts to the value of PIXRST as described in section 7.4.2. To calculate the register value:

- $Px_PRETIME = FLOOR\left(\frac{Px_PRETIME(in\ \mu s) * 120}{HMAX}\right) + 5$ (in A&B mode)
- $Px_PRETIME = FLOOR\left(\frac{Px_PRETIME(in\ \mu s) * 120}{HMAX}\right) + 9$ (in any other mode)

Note : $(FLOOR\left(\frac{Px_PRETIME(in\ \mu s) * 120}{HMAX}\right) + Px_INTEGRATION)$ should not exceed 1ms.

0x4015	7	6	5	4	3	2	1	0
R/W	-	-	-	Px_PRETIME[12:8]				

Reset Value 0x00

0x4016	7	6	5	4	3	2	1	0
R/W	Px_PRETIME[7:0]							

Reset Value 0x0A

Note : Both PREHEAT and PREMIX will increase the system power consumption.

When enabling premixing these other register values have to be updated. Important to know is that the following registers cannot be updated during video streaming.

0x5281	7	6	5	4	3	2	1	0
R/W	-	-	RANDNM7 [21:16]					

Reset Value 0x00

0x5282	7	6	5	4	3	2	1	0
R/W	RANDNM7 [15:8]							

Reset Value 0x05

0x5283	7	6	5	4	3	2	1	0
R/W	RANDNM7 [7:0]							

Reset Value 0x55

RANDNM7 can be calculated as: $1070 + HMAX \cdot \text{FLOOR}\left(\frac{P_x_PRETIME(\text{in } \mu\text{s}) - 11.13}{HMAX} \cdot 120\right)$, with $P_x_PRETIME \geq 11.13$

0x5265	7	6	5	4	3	2	1	0
R/W	-	-	RANDNMO [21:16]					

Reset Value 0x00

0x5266	7	6	5	4	3	2	1	0
R/W	RANDNMO [15:8]							

Reset Value 0x1F

0x5267	7	6	5	4	3	2	1	0
R/W	RANDNMO [7:0]							

Reset Value 0x2C

RANDNMO can be calculated as $HMAX \cdot \text{PIXRST} - \text{RANDNM7} - 2098$
(RANDNM7 = 1070 with premix disabled, more information can be found in section 7.12)

7.13. Px_INTEGRATION

The integration time is configurable for each phase individually and set by units of HMAX. When updating the registers it's advised to use PARAM_HOLD like explained in section 0.

The next boundary conditions have to be taken into account:

- $\frac{HMAX}{120} \mu s < \text{integration time} < 1ms$
- in steps of $\frac{HMAX}{120} \mu s$
- $\frac{\text{Total IntegrationTime}}{\text{Total Frame Time}} = \frac{\sum_{x=0}^7 Px_INTEGRATION + Px_PRETIME}{\text{Total FRAME_TIME}} < 0.4$

The value of registers Px_INTEGRATION can be calculated as $FLOOR\left(\frac{\text{Integration Time (in } \mu s) \cdot 120}{HMAX}\right) \cdot HMAX$

Register Address		Register Name	Default Value
0x2120	R/W	P0_INTEGRATION [31:24]	0x00
0x2121	R/W	P0_INTEGRATION [23:16]	0x01
0x2122	R/W	P0_INTEGRATION [15:8]	0xD4
0x2123	R/W	P0_INTEGRATION [7:0]	0xC0
0x2124	R/W	P1_INTEGRATION [31:24]	0x00
0x2125	R/W	P1_INTEGRATION [23:16]	0x01
0x2126	R/W	P1_INTEGRATION [15:8]	0xD4
0x2127	R/W	P1_INTEGRATION [7:0]	0xC0
0x2128	R/W	P2_INTEGRATION [31:24]	0x00
0x2129	R/W	P2_INTEGRATION [23:16]	0x01
0x212A	R/W	P2_INTEGRATION [15:8]	0xD4
0x212B	R/W	P2_INTEGRATION [7:0]	0xC0
0x212C	R/W	P3_INTEGRATION [31:24]	0x00
0x212D	R/W	P3_INTEGRATION [23:16]	0x01
0x212E	R/W	P3_INTEGRATION [15:8]	0xD4
0x212F	R/W	P3_INTEGRATION [7:0]	0xC0
0x2130	R/W	P4_INTEGRATION [31:24]	0x00
0x2131	R/W	P4_INTEGRATION [23:16]	0x01
0x2132	R/W	P4_INTEGRATION [15:8]	0xD4
0x2133	R/W	P4_INTEGRATION [7:0]	0xC0
0x2134	R/W	P5_INTEGRATION [31:24]	0x00
0x2135	R/W	P5_INTEGRATION [23:16]	0x01
0x2136	R/W	P5_INTEGRATION [15:8]	0xD4
0x2137	R/W	P5_INTEGRATION [7:0]	0xC0
0x2138	R/W	P6_INTEGRATION [31:24]	0x00
0x2139	R/W	P6_INTEGRATION [23:16]	0x01
0x213A	R/W	P6_INTEGRATION [15:8]	0xD4
0x213B	R/W	P6_INTEGRATION [7:0]	0xC0
0x213C	R/W	P7_INTEGRATION [31:24]	0x00
0x213D	R/W	P7_INTEGRATION [23:16]	0x01
0x213E	R/W	P7_INTEGRATION [15:8]	0xD4
0x213F	R/W	P7_INTEGRATION [7:0]	0xC0

Table 23: Integration registers

7.14. Px_PHASE_SHIFT

The phase shift difference between the internal modulation signal (towards the pixels) and the external illumination control signal can be set for each phase independently in steps of 45deg. This phase shift can be calculated as $360 * Px_PHASE_SHIFT / 8$.

0x21B4	7	6	5	4	3	2	1	0
R/W	-	P1_PHASE_SHIFT			-	P0_PHASE_SHIFT		

Reset Value 0x40

0x21B5	7	6	5	4	3	2	1	0
R/W	-	P3_PHASE_SHIFT			-	P2_PHASE_SHIFT		

Reset Value 0x62

0x21B6	7	6	5	4	3	2	1	0
R/W	-	P5_PHASE_SHIFT			-	P4_PHASE_SHIFT		

Reset Value 0x00

0x21B7	7	6	5	4	3	2	1	0
R/W	-	P7_PHASE_SHIFT			-	P6_PHASE_SHIFT		

Reset Value 0x00

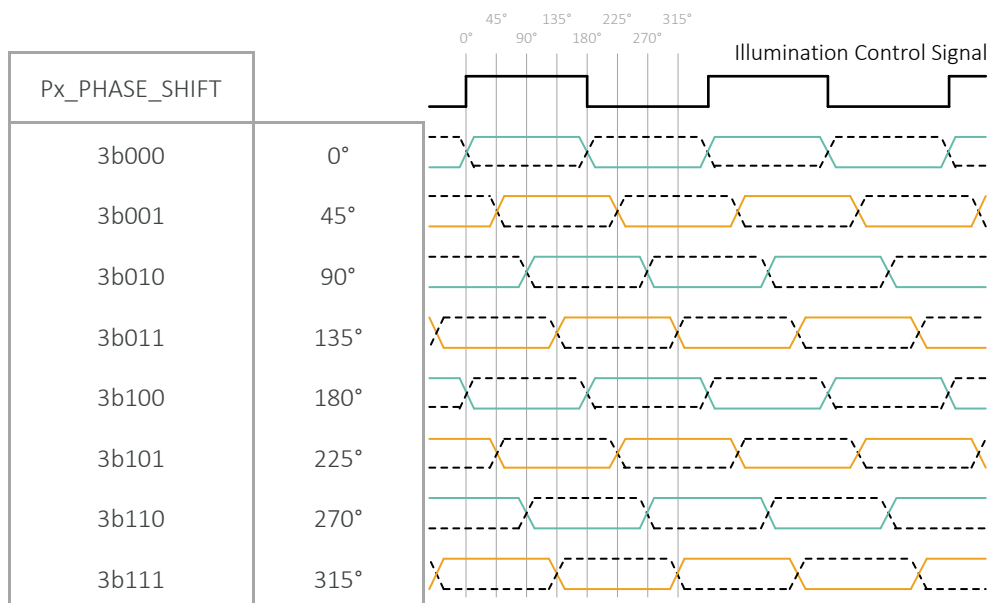

The illumination signal towards the pixels is used as reference by default and the modulation signal towards the pixels (LEDP/LEDN) is shifted in phase. This reference signal can be selected¹.

0x4EA0	7	6	5	4	3	2	1	0
R/W	-	-	-	-	-	-	-	MODREF

Reset Value 0x00

- 1b0: illumination signal is used as reference, internal modulation signal is shifted in phase
- 1b1: internal modulation signal is used as reference, illumination signal is shifted in phase

Note¹ : Changing the reference signal will impact the raw to distance calculation, additionally, This feature is not available on AAA-200 product variants (see section Ordering Information)

7.15. Px_PHASE_IDLE (or V-blanking)

An artificial idle time (wait time or V-blanking) between 2 subsequent phases can be configured. This function negatively impacts the system motion robustness (= the ability to measure fast moving objects), but it can be used for compatibility with certain microcontrollers.

Phase idle time (in ms) can be calculated as $\frac{Px_PHASE_IDLE \cdot HMAX}{120 \cdot 10^3}$

Register Address		Register Name	Default Value
0x21C8	R/W	P0_PHASE_IDLE*	0x05
0x21C9	R/W	P1_PHASE_IDLE*	0x05
0x21CA	R/W	P2_PHASE_IDLE*	0x05
0x21CB	R/W	P3_PHASE_IDLE*	0x05
0x21CC	R/W	P4_PHASE_IDLE*	0x05
0x21CD	R/W	P5_PHASE_IDLE*	0x05
0x21CE	R/W	P6_PHASE_IDLE*	0x05
0x21CF	R/W	P7_PHASE_IDLE*	0x05

Table 24: Phase idle registers

* Values outside [0x05 - 0xFF] are prohibited

7.16. Px_LEDEN

Enable or disable the LEDEN pulse(s). This pulse starts ~55µs before the integration time and ends ~14µs after the integration time. It can be used as an extra control signal for the illumination (for example enable/disable the PSU) or to disable any significant external noise influencers during the integration time & pixel readout time. It can be enabled or disabled for each of the phases individually. The electrical pulse toggles between GND and VIF.

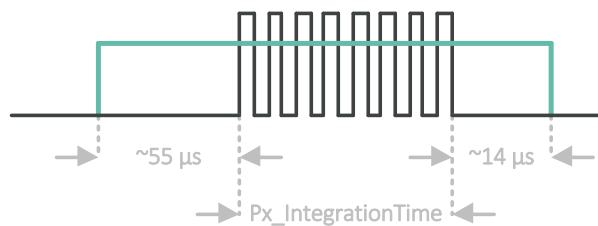

0x21C4	7	6	5	4	3	2	1	0
R/W	P7_LEDEN	P6_LEDEN	P5_LEDEN	P4_LEDEN	P3_LEDEN	P2_LEDEN	P1_LEDEN	P0_LEDEN

Reset Value 0x00

- 1b0: LEDEN pulse disabled
- 1b1: LEDEN pulse enabled

7.17. Px_DMIX0, Px_DMIX1 & Px_STATIC_LED

The patented DepthSense™ pixel design includes 2 internal digital control signals, DMIX0 & DMIX1, that actively forces a guiding field inside the pixel and thus drives, by light photons generated, electrons either to pixel tap A or pixel tap B. In normal operating conditions these signals are modulating during Px_INTEGRATION, but for prototype purposes (or system debugging) it is possible to define their internal behaviour.

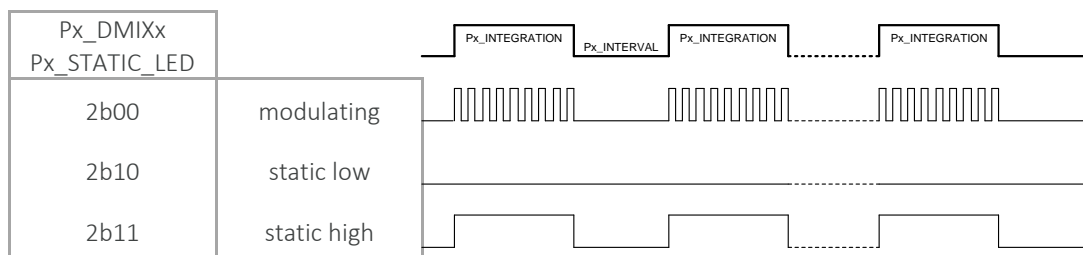

0x21A8	7	6	5	4	3	2	1	0
R/W	P4_DMIX0		P3_DMIX0		P2_DMIX0		P1_DMIX0	

Reset Value 0x00

0x21A9	7	6	5	4	3	2	1	0
R/W	P8_DMIX0		P7_DMIX0		P6_DMIX0		P5_DMIX0	

Reset Value 0x00

0x21AC	7	6	5	4	3	2	1	0
R/W	P4_DMIX1		P3_DMIX1		P2_DMIX1		P1_DMIX1	

Reset Value 0x00

0x21AD	7	6	5	4	3	2	1	0
R/W	P8_DMIX1		P7_DMIX1		P6_DMIX1		P5_DMIX1	

Reset Value 0x00

The same feature is possible for the illumination control signals LEDP & LEDN.

0x21B0	7	6	5	4	3	2	1	0
R/W	P4_STATIC_LED		P3_STATIC_LED		P2_STATIC_LED		P1_STATIC_LED	

Reset Value 0x00

0x21B1	7	6	5	4	3	2	1	0
R/W	P8_STATIC_LED		P7_STATIC_LED		P6_STATIC_LED		P5_STATIC_LED	

Reset Value 0x00

7.18. Pixel Binning

Pixel binning is a technique to combine individual pixels together to create a set of *superpixels*. In binning mode, each pixel is read-out separately but is recombined digitally with its neighbouring pixels inside the sensor to increase the SNR (signal-to-noise ratio) and to decrease the data processing & bandwidth towards the microcontroller. There's no beneficial effect on the total read-out time (= no impact on motion robustness) as each pixel still has to be read out individually. The noise from the pixels is dominated by the photon shot noise according to a Poisson distribution, with a SNR in binning mode proven to increase with:

$$\sqrt{\langle \text{number of binned pixels} \rangle} .$$

0x14A5	7	6	5	4	3	2	1	0
R/W	-	-	-	-	-	-	BINNING_MODE	

Reset Value 0x00

- 2b00: no binning (= VGA resolution, 640x480 pixels)
- 2b01: 2x2 binning (= QVGA resolution, 320x240 pixels)
- 2b10: 4x4 binning (= QQVGA resolution, 160x120 pixels)
- 2b11: 8x8 binning (= QQQVGA resolution, 80x60 pixels)

7.19. Region of Interest (ROI)

Not all applications require the full VGA (640x480) pixel information. To reduce the total frame readout time, the data processing (or bandwidth) and power consumption it is possible to select only a subset of pixels eligible for readout, also known as a region of interest (ROI). Rows have to be read-out in multiples of 2.

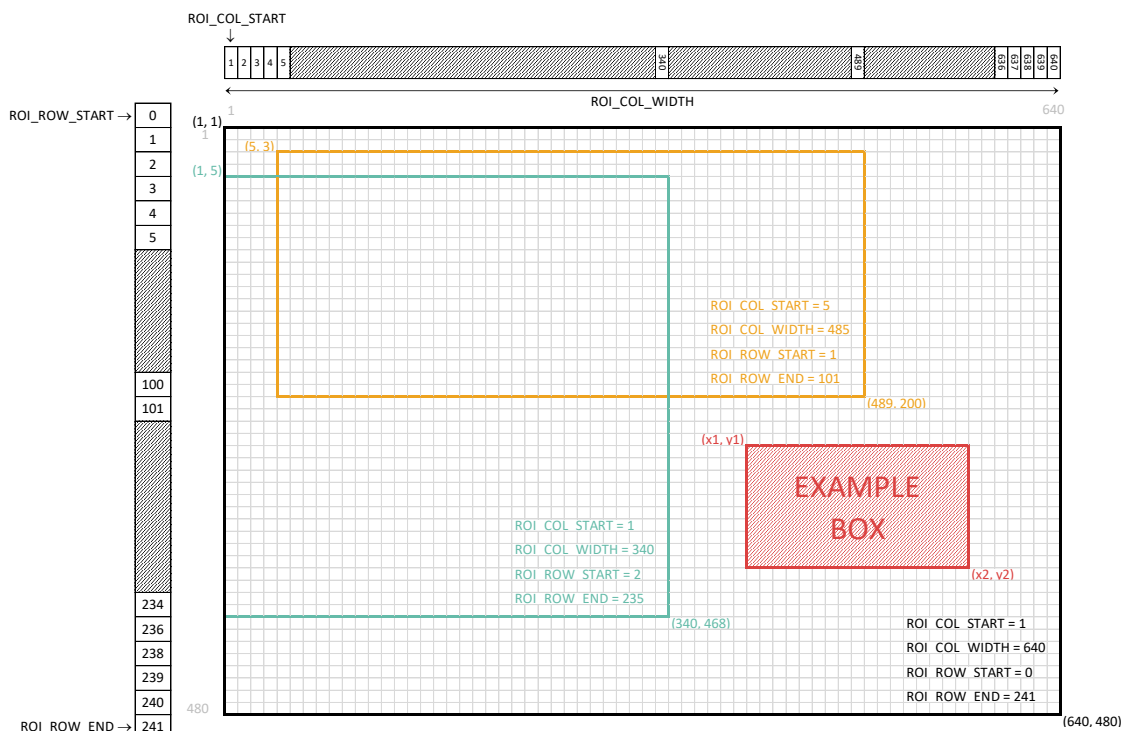

Figure 24: Region of Interest Settings

Note : Changing registers IMG_ORIENTATION_H or IMG_ORIENTATION_V (from section 7.20) also requires the user to reverse the applicable ROI registers for the same region to be readout.

Register Address ¹	Register Name	Calculated Register Value
0x0804 [5:0]	ROI_COL_START [13:8]	x1
0x0805	ROI_COL_START [7:0]	
0x0806 [1:0]	ROI_COL_WIDTH [9:8]	x2 - x1 + 1
0x0807	ROI_COL_WIDTH [7:0]	
0x0808 [0]	ROI_ROW_START [8]	$(y1 - 1) / 2$
0x0809	ROI_ROW_START [7:0]	
0x080A [0]	ROI_ROW_END [8]	$y2 / 2 + 1$
0x080B	ROI_ROW_END [7:0]	

Table 25: Binning registers

When defining the ROI region there is a list of minimum requirements that have to be taken into account: Y1 should be uneven while Y2 is even. The ROI also depends on the binning used.

Binning	Minimum ROI	Min. Column Increment x1,x2	Min. Row Increment y1,y2
x1	8 x 2	multiple of 4	multiple of 2
x2	16 x 2	multiple of 8	multiple of 2
x4	32 x 4	multiple of 16	multiple of 4
x8	64 x 8	multiple of 32	multiple of 8

7.20. Flip & Mirror

The physical sensor orientation on a PCB does not always match with application requirements or with a visually attractive picture for the user. For that reason the images can be vertically flipped and/or horizontally mirrored before they are outputted via the video output interface.

The default read out position starting at pixel 1, like visualized in section 4.1, already inverts the image both vertically & horizontally to compensate for the sensor optics/lens behaviour.

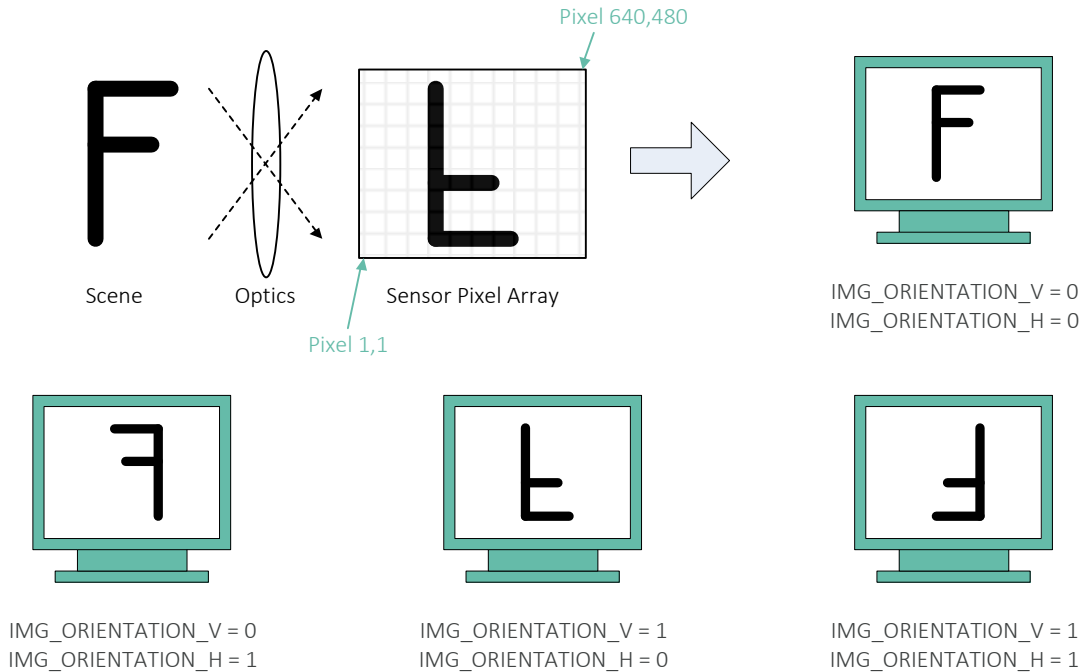

0x080C	7	6	5	4	3	2	1	0
R/W	-	-	-	-	-	-	-	IMG_ORIENTATION_V

Reset Value 0x00

0x080D	7	6	5	4	3	2	1	0
R/W	-	-	-	-	-	-	-	IMG_ORIENTATION_H

Reset Value 0x00

7.21. Temperature Sensor

The internal junction temperature sensor information is available as a register value (or can be found inside the MetaData). The temperature is read right after the integration time and just before the frame readout period like shown in 7.8. It is only valid after a first phase acquisition with an an absolute accuracy of $\pm 7^\circ\text{C}$ @ -40°C , $\pm 5^\circ\text{C}$ @ 60°C , $\pm 6^\circ\text{C}$ @ 125°C .

0x1403	7	6	5	4	3	2	1	0
R/W	TEMP_VALUE							

Reset Value 0x00

$$\text{Temperature [in } ^\circ\text{C]} = \text{TEMP_VALUE} - 40$$

7.22. Pixel & Phase Statistics

MLX75027 monitors each raw tap A and tap B value separately. Statistics are gathered when either of the two taps exceeds their minimum or maximum threshold. Feedback is provided as a single bit error flag or generic pixel error code via the metadata (or via I²C). This data can be used as indicator to warn for pixel saturation or extreme low light conditions. The total amount of erroneous pixels violating their thresholds can be found in Px_ERRORCOUNTLow or Px_ERRORCOUNTHIGH registers for each phase.

0x1433	7	6	5	4	3	2	1	0
R/W	-	-	-	-	-	-	-	STATS_EN

Reset Value 0x01

- 1b0: statistics disabled
- 1b1: statistics enabled

0x14BB	7	6	5	4	3	2	1	0
R/W	-	-	-	-	-	-	-	STATS_MODE

Reset Value 0x00

- 1b0: pixel error flag enabled

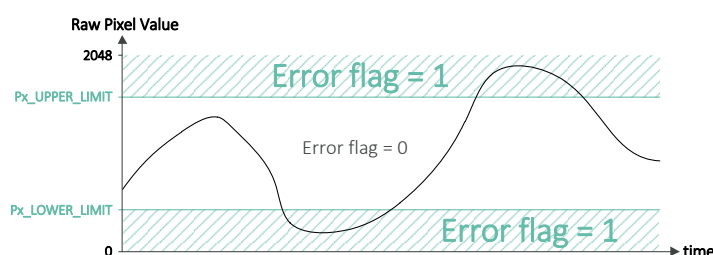

Figure 25: Pixel error flag

- 1b1: pixel error code enabled

The pixel error code is only available for output mode A-B and A+B as shown in Table 26. Please note the pixel error flag replaces the pixel MSB.

Data Output Mode	STATS_EN = 0	STATS_EN = 1	
		STATS_MODE = 0 (Error flag enabled)	STATS_MODE = 1 (Error code enabled)
A-B	[11:0] = pixel data (signed)	[11] = error flag [10:0] = pixel data (signed)	[11:0] = pixel data (signed) or 0x800 (= error code)
A+B	[11:0] = pixel data (unsigned)	[11] = error flag [10:0] = pixel data	[11:0] = pixel data (unsigned) or 0xFFF (= error code)
A B A&B	[11] = 0 [10:0] = pixel data	[11] = error flag [10:0] = pixel data	[11] = 0 [10:0] = pixel data

Table 26: Register Table for Error Info

The minimum threshold for each tap is defined in Px_LOWER_LIMIT.

Register Address		Register Name	Default Value
0x1434	R/W	P1_LOWER_LIMIT [10:8]	0x00
0x1435	R/W	P1_LOWER_LIMIT [7:0]	0x00
0x1436	R/W	P2_LOWER_LIMIT [10:8]	0x00
0x1437	R/W	P2_LOWER_LIMIT [7:0]	0x00
0x1438	R/W	P3_LOWER_LIMIT [10:8]	0x00
0x1439	R/W	P3_LOWER_LIMIT [7:0]	0x00
0x143A	R/W	P4_LOWER_LIMIT [10:8]	0x00
0x143B	R/W	P4_LOWER_LIMIT [7:0]	0x00
0x143C	R/W	P5_LOWER_LIMIT [10:8]	0x00
0x143D	R/W	P5_LOWER_LIMIT [7:0]	0x00
0x143E	R/W	P6_LOWER_LIMIT [10:8]	0x00
0x143F	R/W	P6_LOWER_LIMIT [7:0]	0x00
0x1440	R/W	P7_LOWER_LIMIT [10:8]	0x00
0x1441	R/W	P7_LOWER_LIMIT [7:0]	0x00
0x1442	R/W	P8_LOWER_LIMIT [10:8]	0x00
0x1443	R/W	P8_LOWER_LIMIT [7:0]	0x00

Table 27: Px_LOWER_LIMIT

The maximum threshold for each tap is defined in Px_UPPER_LIMIT.

Register Address		Register Name	Default Value
0x1448	R/W	P1_UPPER_LIMIT [10:8]	0x00
0x1449	R/W	P1_UPPER_LIMIT [7:0]	0x00
0x144A	R/W	P2_UPPER_LIMIT [10:8]	0x00
0x144B	R/W	P2_UPPER_LIMIT [7:0]	0x00
0x144C	R/W	P3_UPPER_LIMIT [10:8]	0x00
0x144D	R/W	P3_UPPER_LIMIT [7:0]	0x00
0x144E	R/W	P4_UPPER_LIMIT [10:8]	0x00
0x144F	R/W	P4_UPPER_LIMIT [7:0]	0x00
0x1450	R/W	P5_UPPER_LIMIT [10:8]	0x00
0x1451	R/W	P5_UPPER_LIMIT [7:0]	0x00
0x1452	R/W	P6_UPPER_LIMIT [10:8]	0x00
0x1453	R/W	P6_UPPER_LIMIT [7:0]	0x00
0x1454	R/W	P7_UPPER_LIMIT [10:8]	0x00
0x1455	R/W	P7_UPPER_LIMIT [7:0]	0x00
0x1456	R/W	P8_UPPER_LIMIT [10:8]	0x00
0x1457	R/W	P8_UPPER_LIMIT [7:0]	0x00

Table 28: Px_UPPER_LIMIT

The total amount of pixels that violate their limit can be read in separate registers:

Register Address		Register Name	Default Value
0x145D [3:0]	R/W	P0_ERRCOUNTLOW [19:16]	0x00
0x145E	R/W	P0_ERRCOUNTLOW [15:8]	0x00
0x145F	R/W	P0_ERRCOUNTLOW [7:0]	0x00
0x1461 [3:0]	R/W	P1_ERRCOUNTLOW [19:16]	0x00
0x1462	R/W	P1_ERRCOUNTLOW [15:8]	0x00
0x1463	R/W	P1_ERRCOUNTLOW [7:0]	0x00
0x1465 [3:0]	R/W	P2_ERRCOUNTLOW [19:16]	0x00
0x1466	R/W	P2_ERRCOUNTLOW [15:8]	0x00
0x1467	R/W	P2_ERRCOUNTLOW [7:0]	0x00
0x1469 [3:0]	R/W	P3_ERRCOUNTLOW [19:16]	0x00
0x146A	R/W	P3_ERRCOUNTLOW [15:8]	0x00
0x146B	R/W	P3_ERRCOUNTLOW [7:0]	0x00
0x146D [3:0]	R/W	P4_ERRCOUNTLOW [19:16]	0x00
0x146E	R/W	P4_ERRCOUNTLOW [15:8]	0x00
0x146F	R/W	P4_ERRCOUNTLOW [7:0]	0x00
0x1471 [3:0]	R/W	P5_ERRCOUNTLOW [19:16]	0x00
0x1472	R/W	P5_ERRCOUNTLOW [15:8]	0x00
0x1473	R/W	P5_ERRCOUNTLOW [7:0]	0x00
0x1475 [3:0]	R/W	P6_ERRCOUNTLOW [19:16]	0x00
0x1476	R/W	P6_ERRCOUNTLOW [15:8]	0x00
0x1477	R/W	P6_ERRCOUNTLOW [7:0]	0x00
0x1479 [3:0]	R/W	P7_ERRCOUNTLOW [19:16]	0x00
0x147A	R/W	P7_ERRCOUNTLOW [15:8]	0x00
0x147B	R/W	P7_ERRCOUNTLOW [7:0]	0x00

Table 29: Total Pixel count Px_LOWER_LIMIT

Register Address		Register Name	Default Value
0x1481 [3:0]	R/W	P0_ERRCOUNTHIGH [19:16]	0x00
0x1482	R/W	P0_ERRCOUNTHIGH [15:8]	0x00
0x1483	R/W	P0_ERRCOUNTHIGH [7:0]	0x00
0x1485 [3:0]	R/W	P1_ERRCOUNTHIGH [19:16]	0x00
0x1486	R/W	P1_ERRCOUNTHIGH [15:8]	0x00
0x1487	R/W	P1_ERRCOUNTHIGH [7:0]	0x00
0x1489 [3:0]	R/W	P2_ERRCOUNTHIGH [19:16]	0x00
0x148A	R/W	P2_ERRCOUNTHIGH [15:8]	0x00
0x148B	R/W	P2_ERRCOUNTHIGH [7:0]	0x00
0x148D [3:0]	R/W	P3_ERRCOUNTHIGH [19:16]	0x00
0x148E	R/W	P3_ERRCOUNTHIGH [15:8]	0x00
0x148F	R/W	P3_ERRCOUNTHIGH [7:0]	0x00
0x1491 [3:0]	R/W	P4_ERRCOUNTHIGH [19:16]	0x00
0x1492	R/W	P4_ERRCOUNTHIGH [15:8]	0x00
0x1493	R/W	P4_ERRCOUNTHIGH [7:0]	0x00
0x1495 [3:0]	R/W	P5_ERRCOUNTHIGH [19:16]	0x00
0x1496	R/W	P5_ERRCOUNTHIGH [15:8]	0x00
0x1497	R/W	P5_ERRCOUNTHIGH [7:0]	0x00
0x1499 [3:0]	R/W	P6_ERRCOUNTHIGH [19:16]	0x00
0x149A	R/W	P6_ERRCOUNTHIGH [15:8]	0x00
0x149B	R/W	P6_ERRCOUNTHIGH [7:0]	0x00
0x149D [3:0]	R/W	P7_ERRCOUNTHIGH [19:16]	0x00
0x149E	R/W	P7_ERRCOUNTHIGH [15:8]	0x00
0x149F	R/W	P7_ERRCOUNTHIGH [7:0]	0x00

Table 30: Total Pixel count Px_UPPER_LIMIT

7.23. PN9 Test Pattern

MLX75027 has a built-in test pattern to verify the MIPI connectivity. This can be used for debugging purposes, but also as live diagnostic. The pattern is a pseudorandom code generated using a nine stage shift register.

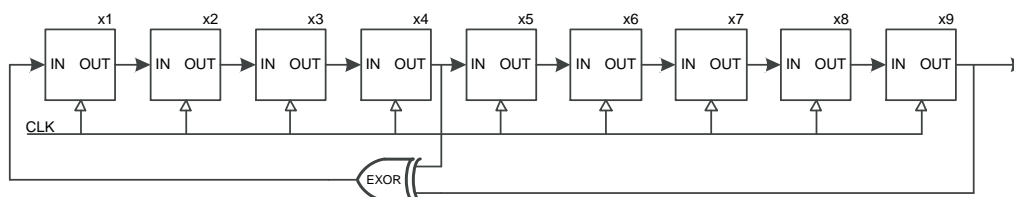

At t_0 each shift register is pre-loaded with one. At every clock pulse the register shifts and the first stage input is replaced with the exclusive disjunction (EXOR operation) from bit 4 and 9. The output stream of register no.9 is recombined into an 8bit word. This sequence generates 512 unique values and will repeat itself.

		MSB								LSB	
$x_9 >$	1	1	1	1	1	1	1	1	1	t_0	
$x_9 >$	0	1	1	1	1	1	1	1	1	t_1	
$x_9 >$	0	0	1	1	1	1	1	1	1	t_2	
$x_9 >$	0	0	0	1	1	1	1	1	1		
$x_9 >$	0	0	0	0	1	1	1	1	1		
$x_9 >$	1	0	0	0	0	1	1	1	1		
$x_9 >$	1	1	0	0	0	0	1	1	1		
$x_9 >$	1	1	1	0	0	0	0	1	1		
$x_9 >$	1	1	1	0	0	0	0	0	1		
$x_9 >$	0	1	1	0	0	0	0	0	1		
$x_9 >$	1	0	1	1	0	0	0	0	1		
$x_9 >$	1	1	1	0	0	0	0	0	1		
$x_9 >$	0	1	1	1	0	0	0	0	1	t_{x-2}	
$x_9 >$	0	0	1	1	1	0	0	0	1	t_{x-1}	
$x_9 >$	0	0	0	1	1	1	0	1	1	t_x	

1	D	E	1	F	F
---	---	---	---	---	---

Recombining this example bitstream into a single MIPI package, like explained in section 5.2.2, becomes 0xFFE11D, which translates into the first two pixels values 0xFFD (4093) and 0xE11 (3601). The bitstream of the next 2 pixels gives 0x85ED9A, which corresponds to a MIPI package of 0x9AED85, representing two pixel values 0x9A5 (2469) and 0xED8 (3800),

The test pattern is independent of the pixel values and output mode but is visually different for mode A&B.

To enable the test pattern, please follow this register sequence:

- Register 0x1405 > value 0x00
- Register 0x1406 > value 0x04
- Register 0x1407 > value 0x01

To disable the test pattern:

- Register 0x1407 > value 0x00

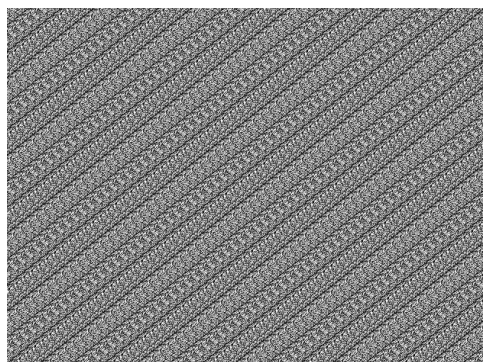

Figure 26: Visual representation of PN9 Test Pattern

7.24. Duty Cycle Adjustment

It is possible to adjust the duty cycle of the illumination signals (LEDP, LEDN). The default duty cycle is 50%, but it can be optimized to compensate certain driver effects. The adjustment is controlled by analogue circuitry in 16 delay steps (on the rising or falling edge of the light pulses). Each step is typically 500ps, but the absolute delay time is affected by process & temperature variation.

0x4E9E	7	6	5	4	3	2	1	0
R/W	-	-	-	-	-	DUTY_CYCLE		

Reset Value 0x00

- 2b00: no duty cycle correction (= disabled)
 - 2b01: time delay on the falling edge (= increased duty cycle)
 - 2b10: time delay on the rising edge (= decreased duty cycle)
- (other values are prohibited)

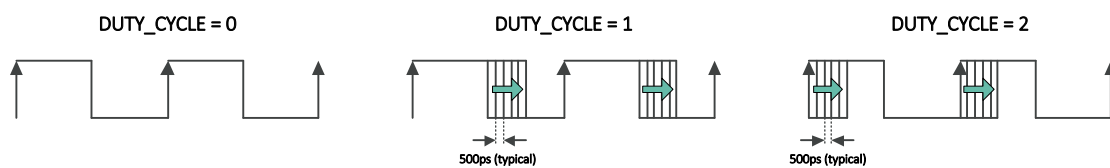

0x21B9	7	6	5	4	3	2	1	0
R/W	-	-	-	-	DUTY_CYCLE_VALUE			

Reset Value 0x00

The total delay (of the rising and falling edge) = DUTY_CYCLE_VALUE · 500 ps (typical value)

Since the step size has an absolute value the duty cycle limits are affected by the modulation frequency. It's the user responsibility to stay within min. & max. limits to avoid illumination hardware failure.

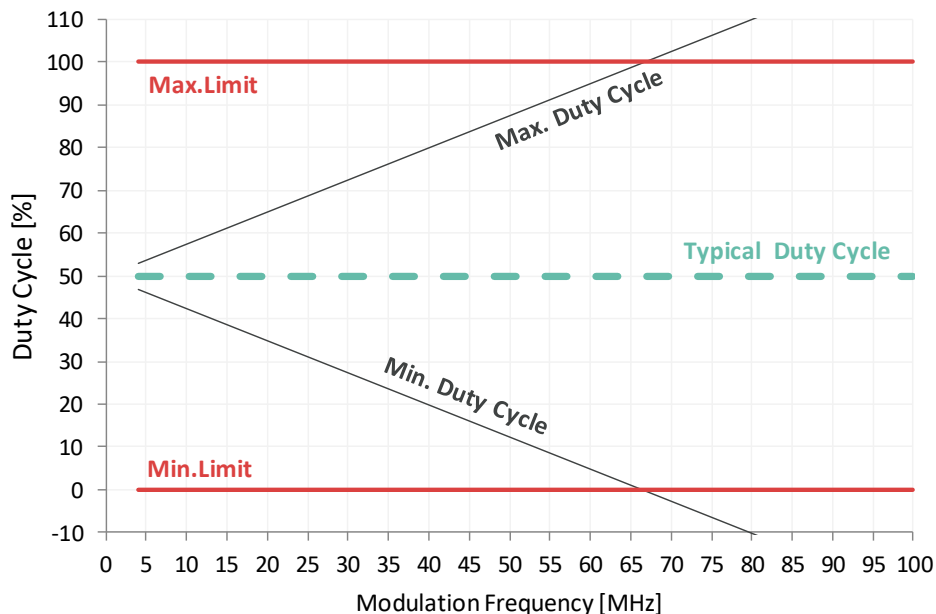

Figure 27: Modulation frequency versus allowed duty cycle

This graph for example shows that the duty cycle at 40 MHz can be changed between 20 & 80 %.

7.25. Illumination Signal (subLVDS or CMOS)

The illumination signal is available as differential signal (subLVDS) or as single ended pulses (CMOS). It is suggested to apply changes to this hardware configuration during the *Software Standby* mode.

0x10E2	7	6	5	4	3	2	1	0
R/W	-	-	-	-	-	-	-	LVDS_EN

Reset Value 0x01

- 1b0: CMOS mode (LEDP = LEDN)
- 1b1: subLVDS mode (LEDP positive, LEDN negative)

Important Note : We strongly recommend to use subLVDS mode for an ultimate sunlight performance. For more detailed information please contact us directly.

8. MetaData Description

MetaData or embedded data is available on two lines after the normal pixel data. These lines can be enabled via EN_META in register 0x3C18. Each line features 132 unique values.

0x3C18	7	6	5	4	3	2	1	0
R/W	-	-	-	-	-	-	-	EN_META

Reset Value 0x02

- 2b00: no metadata lines enabled
- 2b01: first metadata line (line #1) enabled
- 2b10: first & second metadata lines (line #1 and line #2) enabled (other values are prohibited)

Line	Pixel	Description	Line	Pixel	Description
#1	E000	0x0A (= fixed value)	#2	E050	ERRCOUNTLOW [19:16]
#1	E042	IMG_ORIENTATION_V	#2	E052	ERRCOUNTLOW [15:8]
#1	E044	IMG_ORIENTATION_H	#2	E054	ERRCOUNTLOW [7:0]
#1	E058	USER_ID	#2	E058	ERRCOUNTHIGH [19:16]
#1	E062	OUTPUT_MODE	#2	E060	ERRCOUNTHIGH [15:8]
#1	E068	DATA_LANE_CONFIG	#2	E062	ERRCOUNTHIGH [7:0]
#1	E078	[11:4] TEMP_VALUE [3] 1b0 (= fixed value) [2] 1b1 (= fixed value) [1] 1b0 (= fixed value) [0] 1b1 (= fixed value)	#2	E090	FRAME_COUNT (= frame counter)
#1	E082	BINNING_MODE	#2	E096	PHASE_COUNT (= number of phase inside a frame)
#1	E096	DIVSEL	#2	E127	End of Data 0x07
#1	E098	DIVSELPRE	#2	E128	End of Data 0x07
#1	E127	End of Data 0x07	#2	E129	End of Data 0x07
#1	E128	End of Data 0x07	#2	E130	End of Data 0x07
#1	E129	End of Data 0x07	#2	E131	End of Data 0x07
#1	E130	End of Data 0x07			
#1	E131	End of Data 0x07			

RAW12 output example (assuming single data lane configuration):



The data in each line is composed of a tag, data & dummy byte.

Each uneven pixel (E001, E003, E005, ...) is an embedded data line *tag*.



Tag values are listed below:

Tag	Data Byte Description
0x00	Illegal tag, if found treat as End of Data
0x07	End of Data
0xAA	CCI register Index MSB [15:8]
0xA5	CCI register Index LSB [7:0]
0x5A	Auto increment the CCI index after the data byte – valid data (Data byte contains valid CC register data)
0x55	Auto increment the CCI index after the data byte – null data. (A CCI register does NOT exist for the current CCI index, the data byte value is 0x07)
0xFF	Illegal tag, if found treat as End of Data

8.1. Embedded Data Format in 4 Lane MIPI Configuration

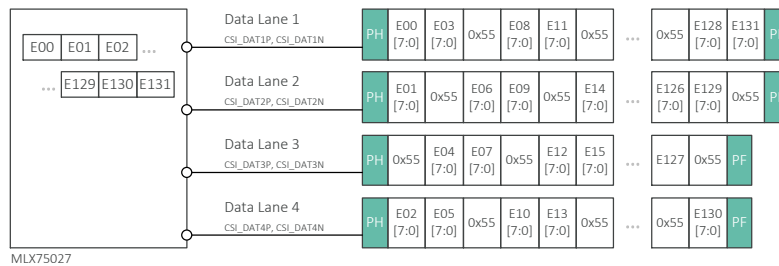

8.2. Embedded Data Format in 2 Lane MIPI Configuration

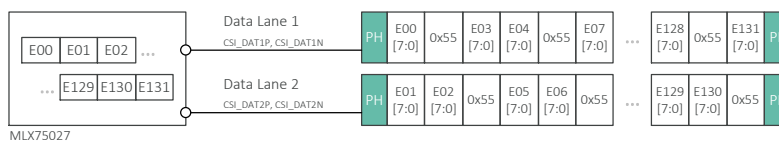

9. Distance & Amplitude Calculation

The distance data per pixel [in mm] can be calculated with the following formulas:

```
p0 = TwoComp_MKO(phase0);  
p180 = TwoComp_MKO(phase180);  
p90 = TwoComp_MKO(phase90);  
p270 = TwoComp_MKO(phase270);  
  
I = p0 - p180;  
Q = p90 - p270; %When 0x4EA0 = 0x01  
  
ampData = sqrt(I.^2 + Q.^2);  
Phase = atan2(I, Q);  
unAmbiguousRange = 0.5*299792458/ModF*1000;  
coef_rad = unAmbiguousRange / (2*pi);  
distData = (Phase+pi) * coef_rad + DistOffset00;  
while sum(distData(distData<0)) ~= 0  
    distData(distData<0) = distData(distData<0) + unAmbiguousRange;  
end
```

Figure 28: Example Matlab code of the raw to distance data calculation

- *phase0, phase180, phase90, phase270* are the raw A-B frames from the sensor at each phase interval
- *TwoComp_MKO* is a local function that converts the unsigned data from Mode A-B for each of the raw phases into signed values
- Calculation of Q depends on the setting of register 0x4EA0 from section 0
- *unAmbiguousRange* is the maximum range in mm determined by the system modulation frequency (at modulation frequency of 20MHz this would be ~7.49m, at 100MHz it will be ~1.49m)
- *coef_rad* is a conversion coefficient from radians to degree
- The *while* loop avoids negative distance values by adding the *unAmbiguousRange* to these negative distance pixels

10. Package Information

10.1. Transmittance and reflectivity

The double sided anti-reflective coating covers the complete glass lid as seen in the Mechanical Dimensions. The refractive index of the glass is: $n=1.51$. The following data represents the transmittance and reflectivity of both the glass and double-sided anti-reflective coating.

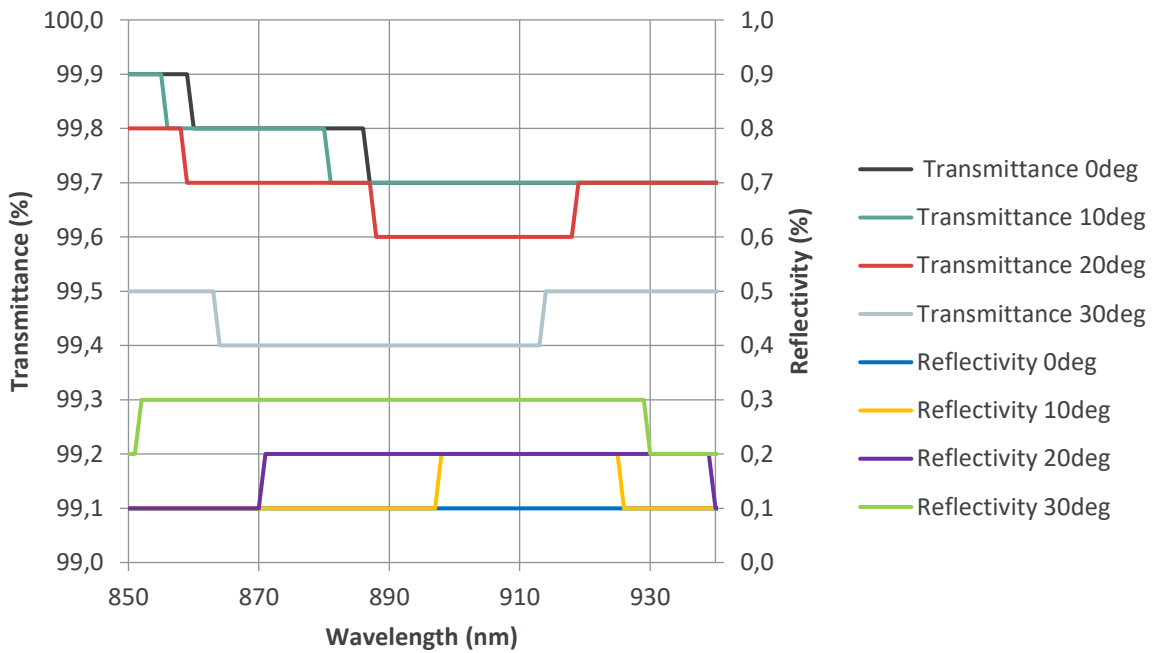

Figure 29: Transmittance and reflectivity

10.2. Pinout & Equivalent I/O Circuitry

Designator	Pin	Function	Voltage Domain	Equivalent I/O Circuitry
SLASEL	A4	Slave select, choose between I ² C slave address 0x57 or 0x67 (digital input)	0 - 1V8	
TRIGGER	K11	Trigger input with MODE=0, trigger output indicator with MODE=1 (active low digital I/O)	0 - 1V8	
SCL	B5	I ² C clock (digital I/O)	0 - 1V8	
SDA	A5	I ² C data (digital I/O)	0 - 1V8	
LEDEN	K3	Optional external control signal (digital output)	0 - 1V8	
LEDP	L3	Positive differential illumination control signal	0 - 1V8	
LEDN	L4	Negative differential illumination control signal	0 - 1V8	
CLK	B3	Input clock of 8 MHz (digital input)	0 - 1V8	
LEDFB	L2	LED feedback control (digital input)	0 - 1V8	
RESETB	A2	Generic device reset (active low digital input)	0 - 1V8	
CSI_CLKN	G1	Digital output		MIPI D-PHY
CSI_CLKP	G2	Digital output		MIPI D-PHY
CSI_DAT1N	H2	Digital output		MIPI D-PHY
CSI_DAT1P	H1	Digital output		MIPI D-PHY
CSI_DAT2N	F1	Digital output		MIPI D-PHY
CSI_DAT2P	F2	Digital output		MIPI D-PHY
CSI_DAT3N	J2	Digital output		MIPI D-PHY
CSI_DAT3P	J1	Digital output		MIPI D-PHY
CSI_DAT4N	E1	Digital output		MIPI D-PHY
CSI_DAT4P	E2	Digital output		MIPI D-PHY

Table 31a: Pinout

Designator	Pin	Function	Voltage Domain	I/O Equivalent Circuitry
VDDA	A7 B2 C12 E12 G12 M2 M11	Analog supply voltage	2V7	
VDDD	C2 C3 D1 K1 K2	Digital supply voltage	1V2	
VDDMIX	L5 L6 L7 L8 L9 L10	High current supply voltage for the mix driver	1V2	
VDDIF	A3 B6 L1 B12	Supply voltage for I/O interface	1V8	
VBO1	E11	Decoupled to AGND (4.7μF)	2V7	
VBO2	G11	Decoupled to AGND (4.7μF)	2V7	n/A
VRSTL	F12	Decoupled to AGND (1μF)	0V5	n/A
VRL1	C11	Decoupled to AGND (4.7μF)	-1V2	n/A
VRL2	F11	Decoupled to AGND (4.7μF)	-1V2	n/A
AGND	B1 B8 B11 D11 D12 M5 M6 M7 M8 M9 M10	Analog ground	GND	
DGND	A8 A9 A10 A11 B9 B10 C1 C4 C5 C6 C7	Digital ground	GND	

Table 31b: Pinout

Designator	Pin	Function	Voltage Domain	I/O Equivalent Circuitry
DGND (continued)	C8	Digital ground	GND	
	C9			
	C10			
	D2			
	D3			
	D4			
	D5			
	D6			
	D7			
	D8			
	D9			
	D10			
	E3			
	E4			
	E5			
	E6			
	E7			
	E8			
	E9			
	E10			
	F3			
	F4			
	F5			
	F6			
	F7			
	F8			
	F9			
	F10			
	G3			
	G4			
	G5			
	G6			
	G7			
	G8			
	G9			
	G10			
	H3			
	H4			
	H5			
	H6			
H7				
H8				
H9				
H10				
J3				
J4				
J5				
J6				
J7				
J8				
J9				
J10				

Table 31c: Pinout

Designator	Pin	Function	Voltage Domain	I/O Equivalent Circuitry
DGND (continued)	K4 K5 K6 K7 K8 K9 K10 L11	Digital ground	GND	
n.c.	A1 A6 B4 B7 H11 H12 J11 J12 K12 L12 M3 M4	Do not connect	Floating	n/A

Table 31d: Pinout

An overlay of these pins and the package can be found here:

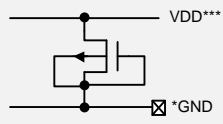
BOTTOM VIEW

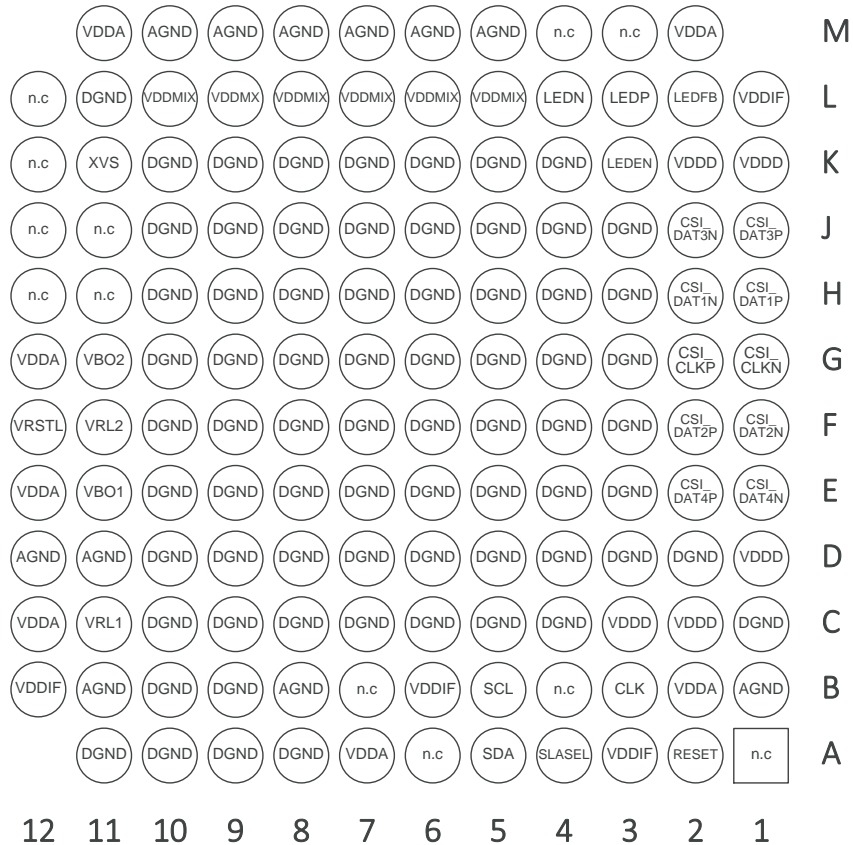

Figure 30: Package pinout

10.3. Mechanical Dimensions

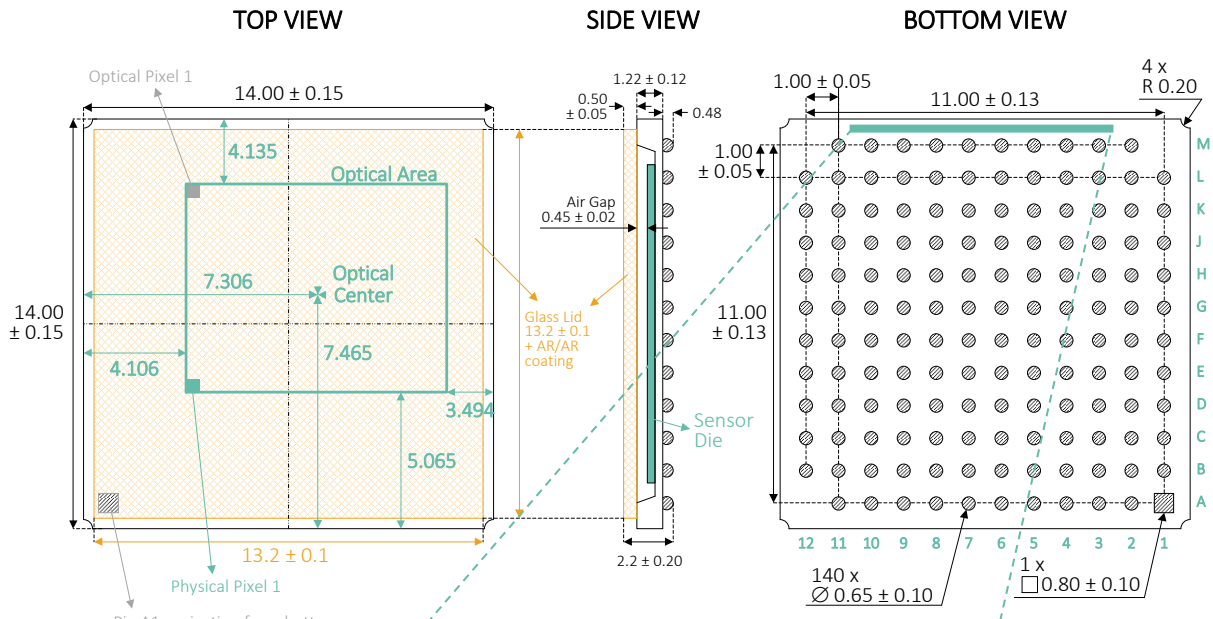

Figure 31: Mechanical Dimensions (in millimeter)

10.4. Package Marking

MLX75027	12345678	YYWW
PRODUCT NAME	LOT CODE	DATE CODE

10.5. PCB Landing Pattern

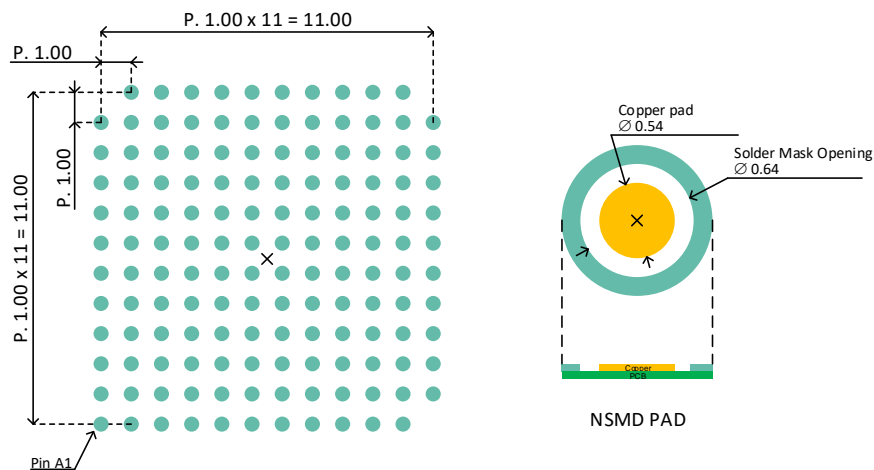

Figure 32: PCB landing pattern

*pin A1 is not a solderpad

10.6. Reflow Solder Profile

MLX75027 reflow temperature profile is based on IPC/JEDEC joint industry standard J-STD-020C Rev C.

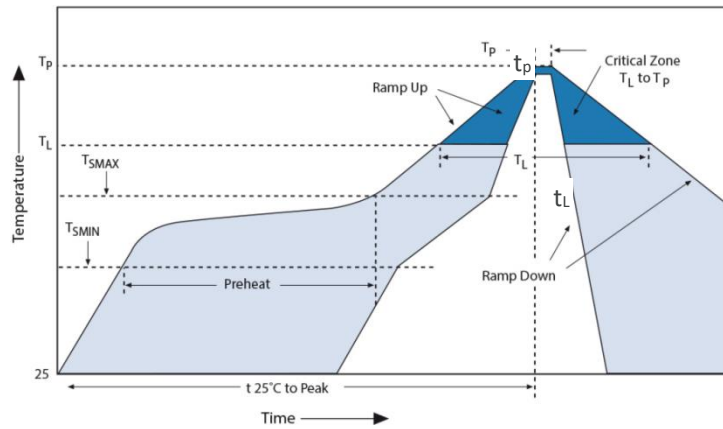

Figure 33: J-STD-020C reflow temperature profile

Profile Feature	Symbol	Lead-Free Assembly
Average ramp up rate	Ramp Up	3°C / second max.
Preheat temperature	$T_{SMIN} - T_{SMAX}$	150°C - 200°C
Preheat time	Preheat	60 - 180 seconds
Peak temperature	$T_L - T_P$	245°C - 60°C
Time within 5°C of actual peak temperature	$t_p - t_L$	20 - 40 seconds
Ramp down rate	Ramp Down	6°C / second max.
Time 25°C to peak temperature	T 25°C to Peak	8 minutes max.

Table 32: Reflow profile

10.7. Reflow Cleaning Instructions

Without using *no-clean* solder we recommend cleaning the sensor surface after component assembly with nitrogen gas, distilled water or isopropanol to remove any flux residues. Do NOT use sodium hydroxide, other highly alkaline solutions or acetone as this would damage the anti-reflective coating on the glass surface. Ultrasonic chip cleaning is prohibited, as it can result in dust emission from cut surfaces.

10.8. Moisture Sensitivity Level

The package is MSL 3 rated.

Disclaimer

Devices sold by Melexis are covered by the warranty and patent indemnification provisions appearing in its Term of Sale. Melexis makes no warranty, express, statutory, implied, or by description regarding the information set forth herein or regarding the freedom of the described devices from patent infringement. Melexis reserves the right to change specifications and prices at any and without notice. Therefore, prior to designing this product into a system, it is necessary to check with Melexis for current information. This product is intended for use in normal commercial applications. Applications requiring extended temperature range, unusual environmental requirements, or high reliability applications, such as military, medical life-support or life-sustaining equipment are specifically not recommended without additional processing by Melexis for each application. The information furnished by Melexis is believed to be correct and accurate. However, Melexis shall not be liable to recipient or any third party for any damages, including but not limited to personal injury, property damage, loss of profits, loss of use, interrupt of business or indirect, special incidental or consequential damages, of any kind, in connection with or arising out of the furnishing, performance or use of the technical data herein. No obligation or liability to recipient or any third party shall arise or flow out of Melexis' rendering of technical or other services.

© 2013 Melexis NV. All rights reserved.

www.melexis.com

DepthSense™ is Trademark of Sony Corporation.

Данный компонент на территории Российской Федерации

Вы можете приобрести в компании MosChip.

Для оперативного оформления запроса Вам необходимо перейти по данной ссылке:

<http://moschip.ru/get-element>

Вы можете разместить у нас заказ для любого Вашего проекта, будь то серийное производство или разработка единичного прибора.

В нашем ассортименте представлены ведущие мировые производители активных и пассивных электронных компонентов.

Нашей специализацией является поставка электронной компонентной базы двойного назначения, продукции таких производителей как XILINX, Intel (ex.ALTERA), Vicor, Microchip, Texas Instruments, Analog Devices, Mini-Circuits, Amphenol, Glenair.

Сотрудничество с глобальными дистрибьюторами электронных компонентов, предоставляет возможность заказывать и получать с международных складов практически любой перечень компонентов в оптимальные для Вас сроки.

На всех этапах разработки и производства наши партнеры могут получить квалифицированную поддержку опытных инженеров.

Система менеджмента качества компании отвечает требованиям в соответствии с ГОСТ Р ИСО 9001, ГОСТ РВ 0015-002 и ЭС РД 009

Офис по работе с юридическими лицами:

105318, г.Москва, ул.Щербаковская д.3, офис 1107, 1118, ДЦ «Щербаковский»

Телефон: +7 495 668-12-70 (многоканальный)

Факс: +7 495 668-12-70 (доб.304)

E-mail: info@moschip.ru

Skype отдела продаж:

moschip.ru

moschip.ru_4

moschip.ru_6

moschip.ru_9