



Main

Range of product	OsiSense XU
Series name	Application material handling
Electronic sensor type	Photo-electric sensor
Sensor name	XUY
Sensor design	Compact
Detection system	Diffuse with background suppression
Material	Plastic
Type of output signal	Discrete
Supply circuit type	DC
Wiring technique	4-wire
Discrete output type	PNP and NPN
Discrete output function	1 NO or 1 NC programmable
Electrical connection	1 male connector M8, 4 pins
Product specific application	2 channels triangulation Control of filling Detection of object on conveyor against reflective background
Emission	Infrared LED, modulated
[Sn] nominal sensing distance	1.97...23.62 in (50...600 mm)

Complementary

Enclosure material	Glass impregnated nylon
Output type	Solid state
Status LED	1 LED (green) output state
[Us] rated supply voltage	12...24 V DC with reverse polarity protection
Supply voltage limits	10...30 V DC
Switching capacity in mA	100 mA (overload and short-circuit protection)
Switching frequency	> 370 Hz
Voltage drop	< 2 V (closed state)
Current consumption	< 1.5 mA (no-load)
Delay response	< 1.8 ms
Delay recovery	< 1.8 ms
Product weight	0.12 lb(US) (0.055 kg)

Environment

product certifications	CE
ambient air temperature for operation	32...122 °F (0...50 °C)
ambient air temperature for storage	-4...140 °F (-20...60 °C)
immunity to ambient light	10000 lux with natural light 1300 lux with incandescent bulb
IP degree of protection	IP65 conforming to IEC 60529

Offer Sustainability

WARNING: This product can expose you to chemicals including:	WARNING: This product can expose you to chemicals including:
Diisononyl phthalate (DINP), which is known to the State of California to cause cancer, and	Diisononyl phthalate (DINP), which is known to the State of California to cause cancer, and
Di-isodecyl phthalate (DIDP), which is known to the State of California to cause birth defects or other reproductive harm.	Di-isodecyl phthalate (DIDP), which is known to the State of California to cause birth defects or other reproductive harm.

The information provided in this documentation contains general descriptions and/or technical characteristics of the products contained herein. This documentation is not intended as a substitute for and is not to be used for determining suitability or reliability of these products for specific user applications. It is the duty of any such user or integrator to perform the appropriate and complete risk analysis, evaluation and testing of the products with respect to the relevant specific application or use thereof. Neither Schneider Electric Industries SAS nor any of its affiliates or subsidiaries shall be responsible or liable for misuse of the information contained herein.

Contractual warranty

Warranty period	18 months
-----------------	-----------

Dimensions

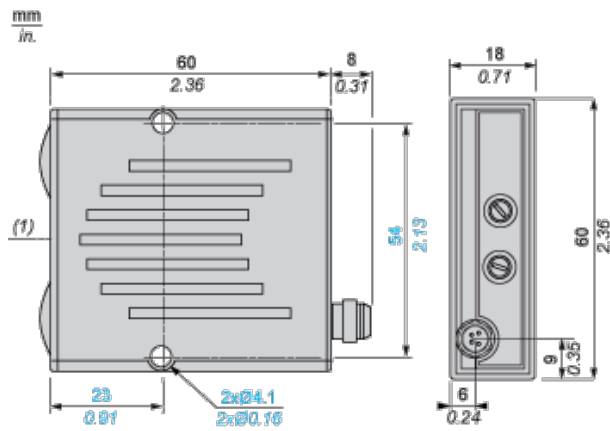

(1) Optical axis

Mounting and Clearance

Two independent sensors with triangulation: A, B

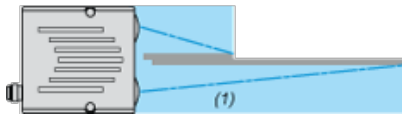

(1) Detected zones

Immunity to reflection: A and B

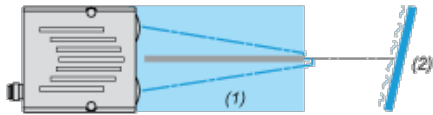

(1) Detected zones

(2) Mirror

Detection of contrasting objects: A or B

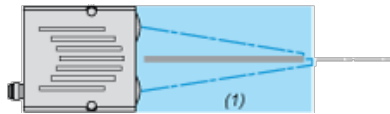

(1) Detected zones

Monitoring of distance: A xor B

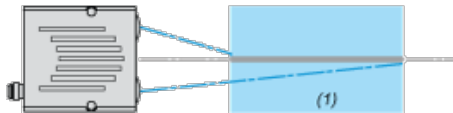

(1) Detected zones

Wiring Schemes and Outputs

Two Independent Sensors with Triangulation: A, B

NO Output

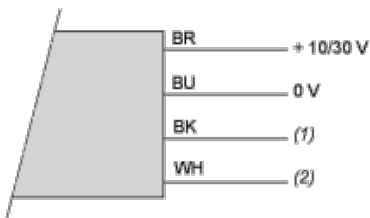

NC Output

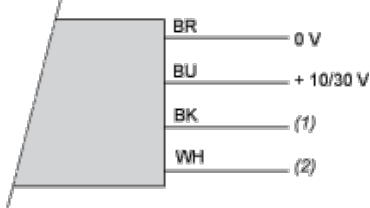

BN : Brown

BU : Blue

BK : Black

WH :White

(1) Zone A output

(2) Zone B output

Immunity to Reflection: A and B

Without Time Delay

NO Output

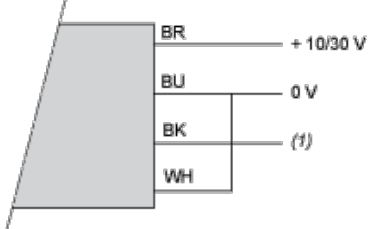

NC Output

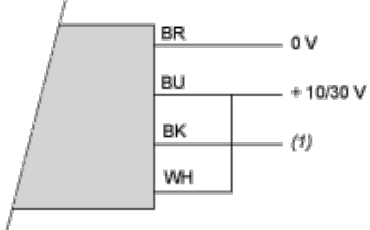

BN : Brown

BU : Blue

BK : Black

WH :White

(1) Output

With 40 ms Time Delay

NO Output

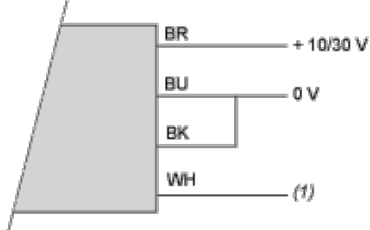

NC Output

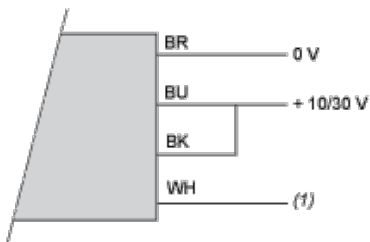

BN : Brown
 BU : Blue
 BK : Black
 WH :White
 (1) Output

Detection of Contrasting Objects: A or B

NO Output

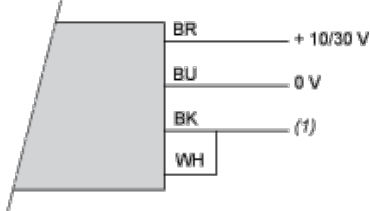

NC Output

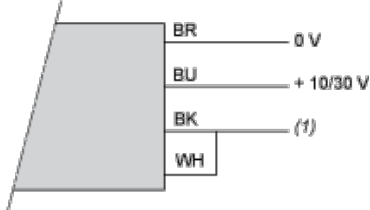

BN : Brown
 BU : Blue
 BK : Black
 WH :White
 (1) Output

Monitoring of Distance: A or B

Without Time Delay

NO Output

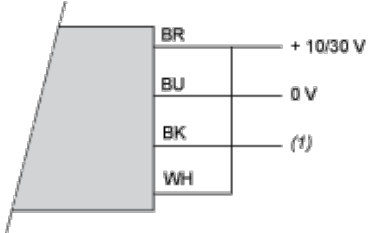

NC Output

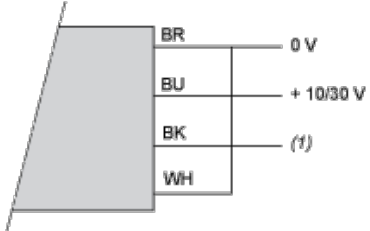

BN : Brown
 BU : Blue
 BK : Black
 WH :White
 (1) Output

With 40 ms Time Delay

NO Output

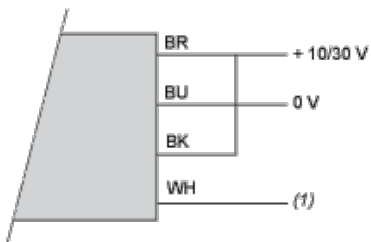

NC Output

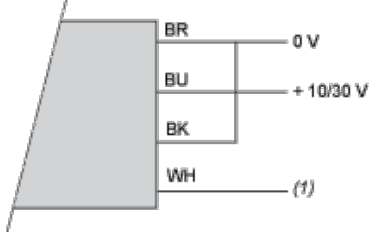

BN : Brown

BU : Blue

BK : Black

WH : White

(1) Output

Detection Curves

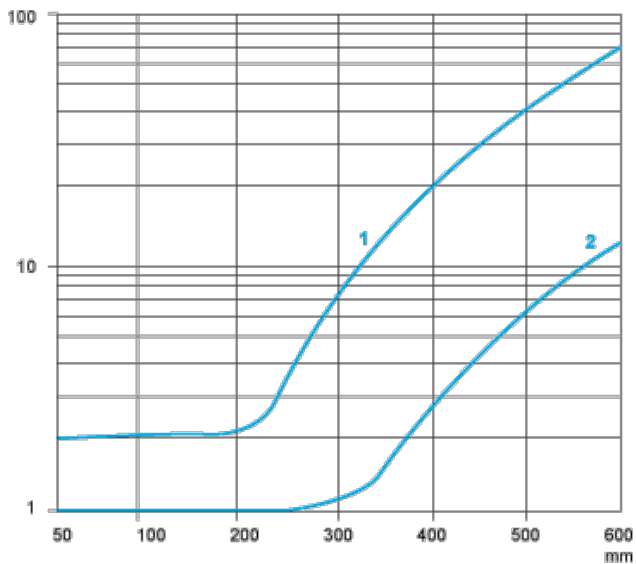

1 : Black 6%

2 : Grey 18% - Distance (mm) set on 92% (Kodak 1527795)

Данный компонент на территории Российской Федерации

Вы можете приобрести в компании MosChip.

Для оперативного оформления запроса Вам необходимо перейти по данной ссылке:

<http://moschip.ru/get-element>

Вы можете разместить у нас заказ для любого Вашего проекта, будь то серийное производство или разработка единичного прибора.

В нашем ассортименте представлены ведущие мировые производители активных и пассивных электронных компонентов.

Нашей специализацией является поставка электронной компонентной базы двойного назначения, продукции таких производителей как XILINX, Intel (ex.ALTERA), Vicor, Microchip, Texas Instruments, Analog Devices, Mini-Circuits, Amphenol, Glenair.

Сотрудничество с глобальными дистрибьюторами электронных компонентов, предоставляет возможность заказывать и получать с международных складов практически любой перечень компонентов в оптимальные для Вас сроки.

На всех этапах разработки и производства наши партнеры могут получить квалифицированную поддержку опытных инженеров.

Система менеджмента качества компании отвечает требованиям в соответствии с ГОСТ Р ИСО 9001, ГОСТ РВ 0015-002 и ЭС РД 009

Офис по работе с юридическими лицами:

105318, г.Москва, ул.Щербаковская д.3, офис 1107, 1118, ДЦ «Щербаковский»

Телефон: +7 495 668-12-70 (многоканальный)

Факс: +7 495 668-12-70 (доб.304)

E-mail: info@moschip.ru

Skype отдела продаж:

moschip.ru

moschip.ru_4

moschip.ru_6

moschip.ru_9