

Features

- Output: Non-isolated
 - 1.5V or 1.8V @ 20 Amps
 - 2.5V or 3.3V @ 15 or 20 Amps
- Input Voltage: 4.75-5.5V (5V nominal)
- Package: 2" x 2" x 0.49" open-frame with attached heat sink
- Full synchronous-rectifier topology
- Efficiencies as high as 91%
- Noise as low as 75mVp-p
- Stable no-load operation
- Excellent thermal derating
- Output short-circuit protection
- On/off control, trim and sense functions
- UL60950/EN60950 certified
- Qual tested, HALT tested, EMI tested

OBSOLETE PRODUCT

Last time buy: 3 March 2014

Click here for more information.

DATE: 11/15/13
 users of these converters (1.5-3.3VOUT) are encouraged to purchase a unique part number (UNR30-66W) for their applications. These converters are designed to operate in a wide temperature range (30-66°C typical, -40 to +70°C maximum). They provide a regulated output (±0.5%) and feature low noise (typically 75mVp-p) and quick step response (50msec). Their feature set includes V_{OUT} trim capability, an on/off control function, output remote-sense pins, and output overcurrent detection and short-circuit protection ("hiccup" technique with auto-recovery). Their unique package integrates an anodized aluminum heat sink with the circuit's thermal-clad aluminum baseplate. With minimal air flow (100lfm), all models deliver full output power/current up to +65°C.

All UNR 30-66W Open-Frame DC/DC Converters are UL1950/EN60950 certified. Safety certifications, EMC compliance test reports, and qualification (including HALT) test reports are available upon request.

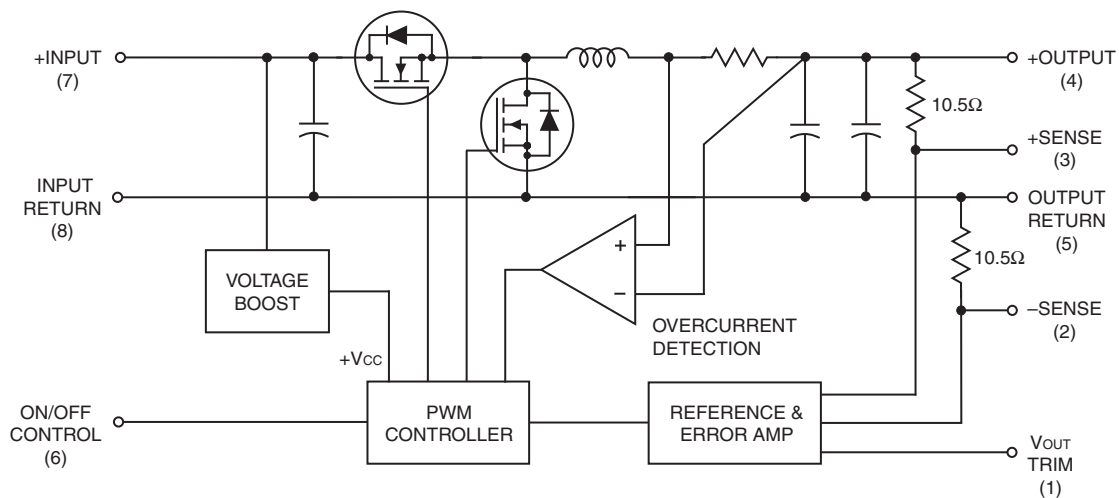

Figure 1. Simplified Schematic



For full details go to
www.murata-ps.com/rohs

Performance Specifications and Ordering Guide ^①

Root Model ^⑤	Output						Input			Efficiency		Package (Case, Pinout)
	V _{OUT} (Volts)	I _{OUT} (Amps)	R/N (mVp-p) ^②		Regulation (Max.)		V _{IN} Nom. (Volts)	Range (Volts)	I _{IN} ^④ (mA/A)	Min.	Typ.	
			Typ.	Max.	Line	Load ^③						
UNR-1.5/20-D5	1.5	20	80	100	±0.1%	±0.5%	5	4.75-5.5	150/7080	82.5%	84%	C21, P26
UNR-1.8/20-D5	1.8	20	80	100	±0.1%	±0.5%	5	4.75-5.5	150/8500	83.5%	85%	C21, P26
UNR-2.5/15-D5	2.5	15	75	120	±0.1%	±0.5%	5	4.75-5.5	150/8430	86%	89%	C21, P26
UNR-2.5/20-D5	2.5	20	75	120	±0.1%	±0.5%	5	4.75-5.5	150/11360	83%	86%	C21, P26
UNR-3.3/15-D5	3.3	15	75	120	±0.1%	±0.5%	5	4.75-5.5	150/10880	87%	91%	C21, P26
UNR-3.3/20-D5	3.3	20	75	120	±0.1%	±0.5%	5	4.75-5.5	150/14830	86%	89%	C21, P26

① Typical at T_A = +25°C under nominal line voltage and full-load conditions, unless otherwise noted. All models are tested and specified with a 22µF output capacitor with a 200mΩ ESR and a 4000µF input capacitor with 9.75Arms ripple-current rating and 20mΩ ESR. See I/O Filtering and Noise Reduction for more details.

② Ripple/Noise (R/N) is tested/specified over a 20MHz bandwidth. Output noise may be further reduced by installing additional external output caps. See I/O Filtering and Noise Reduction.

③ These devices have no minimum-load requirements and will regulate under no-load conditions.

④ Nominal line voltage, no-load/full-load conditions.

⑤ These are only partial part numbers. Refer to the part number structure when ordering.

PART NUMBER STRUCTURE

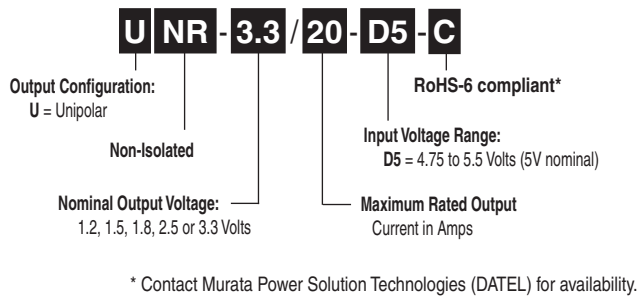

MECHANICAL SPECIFICATIONS

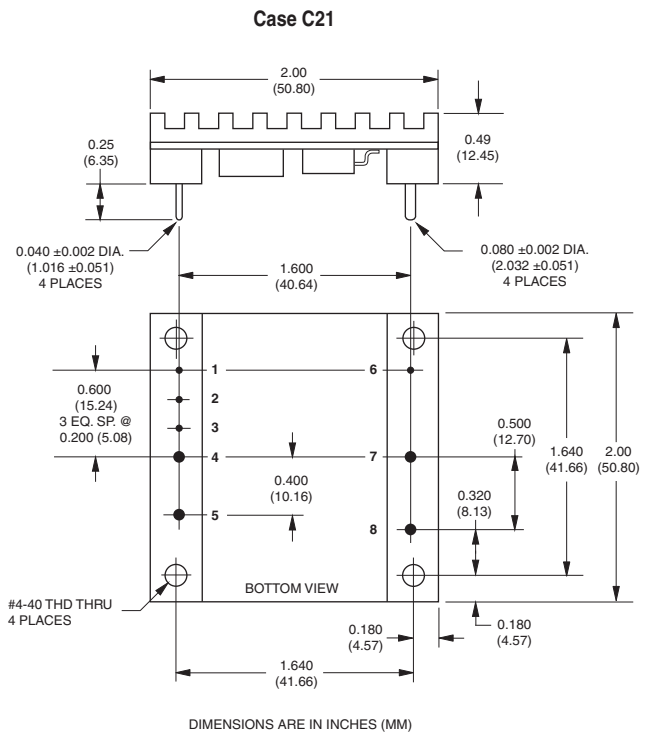

I/O Connections	
Pin	Function P26
1	Trim
2	-Sense
3	+Sense
4	+Output
5	Output Return
6	On/Off Control
7	+Input
8	Input Return

Performance/Functional Specifications

Typical @ Ta = +25°C under nominal line voltage and full-load conditions unless noted. ①

Input	
Input Voltage Range	4.75 to 5.5 Volts (5V nominal)
Input Current:	
Normal Operating Conditions	See Ordering Guide
Standby/Off Mode	TBD
Input Ripple Current:	
UNR-1.5/20-D5, UNR-1.8/20-D5	260mA _{p-p}
UNR-2.5/15-D5	150mA _{p-p}
UNR-2.5/20-D5	140mA _{p-p}
UNR-3.3/15-D5	100mA _{p-p}
UNR-3.3/20-D5	150mA _{p-p}
Input Filter Type	Capacitive (74µF)
Overshoot Protection	None
Reverse-Polarity Protection	None
On/Off Control (Pin 6) ③	On = open or +4V to +VIN; I _{IN} = TBD Off = +0.4V to 1V; I _{IN} = TBD
Output	
V_{OUT} Accuracy (50% load)	±1% maximum
V_{OUT} Trim Range (3.3V_{OUT} models): ④	
Trim pin tied to +Output	V _{OUT} = <1.53 Volts
Trim pin tied to Output Return	V _{OUT} = >3.6 Volts
Minimum Loading	No load
Temperature Coefficient	±0.02% per °C
Ripple/Noise (20MHz BW)	See Ordering Guide
Line/Load Regulation	See Ordering Guide
Efficiency	See Ordering Guide
Overshoot Protection: ②	
Technique	"Hiccup" with auto-recovery
15 Amp Models	146 to 173% (160% typical)
20 Amp Models	115 to 130% (120% typical)
Average Output Current	1 Amp typical, 3 Amps maximum
Dynamic Characteristics	
Transient Response (50 to 75% step)	50µsec to ±2% of final value
Start-Up Time: ⑤	
V _{IN} to V _{OUT}	30msec
On/Off to V _{OUT}	30msec
Switching Frequency	200kHz (±20kHz)
Environmental	
Operating Temperature (Ambient): ⑥	
Without Derating	-40 to +35-65°C
With Derating	to +100°C (See Derating Curves)
Storage Temperature	-40 to +105°C
Physical	
Dimensions	2" x 2" x 0.49" (51 x 51 x 12.45mm)
Shielding	Open-frame
Attached Heatsink	Black anodized aluminum
Circuit Board	Single-layer conductors on aluminum base
Pin Material	RoHS: Gold plate over copper alloy Non-RoHS: Tin over copper alloy
Weight	1.7 ounces (48.2 grams)
Flammability	UL 94V-0

- ① All models are tested and specified with a 22µF output capacitor with a 200mΩ ESR and a 4000µF input capacitor with 9.75Arms ripple-current rating and 20mΩ ESR. See I/O Filtering and Noise Reduction for more details. These devices have no minimum-load requirements and will regulate under no-load conditions.
- ② See Output Overcurrent Detection for details.
- ③ See On/Off Control for details.
- ④ See Output Voltage Trimming for details.
- ⑤ See Start-Up Time for details.
- ⑥ See Temperature Derating for details.

Absolute Maximum Ratings

Input Voltage:	
Continuous	5 Volts
Transient (100msec)	7 Volts
Input Reverse-Polarity Protection	None
Input/Output Overvoltage Protection	None
Output Current	Current limited. Devices can withstand a sustained output short circuit without damage.
Storage Temperature	-40 to +105°C
Lead Temperature (Soldering, 10 sec.)	+300°C

These are stress ratings. Exposure of devices to any of these conditions may adversely affect long-term reliability. Proper operation under conditions other than those listed in the Performance/Functional Specifications Table is not implied.

TECHNICAL NOTES

Return Current Paths

These are non-isolated DC/DC converters. The Input Return and Output Return pins are connected to each other internally. To the extent possible, all input and load currents should be returned through the Input Return and Output Return, respectively (via low-impedance runs). Any control signals applied to the On/Off Control pin should be referenced to Input/Output Return.

I/O Filtering and Noise Reduction

All models in the UNR 30-66W Series are tested and specified with an external 22µF output capacitor (200mΩ ESR) and a 4000µF input capacitor with a 9.75Arms ripple-current rating. External input capacitance is required and must be rated to handle the input ripple current as follows:

$$I_{RMS} = I_{OUT} \sqrt{\frac{V_{OUT}}{V_{IN}} \left(1 - \frac{V_{OUT}}{V_{IN}}\right)}$$

(The large value of the input capacitor is due mainly to output characteristics of DATEL's outgoing ATE test system. Ripple current rating is an important consideration for the end user.) In critical applications, input/output ripple/noise may be further reduced by installing additional I/O caps.

External input capacitors serve primarily as energy-storage elements. They should be selected for bulk capacitance (at appropriate frequencies), low ESR, and high rms-ripple-current ratings. The switching nature of modern DC/DC converters requires that dc input voltage sources have low ac impedance, and highly inductive source impedances can affect system stability. Your specific system configuration may necessitate additional considerations.

Output ripple/noise (also referred to as periodic and random deviations or PARD) can be reduced below specified limits using filtering techniques, the simplest of which is the installation of additional external output capacitors. Output capacitors function as true filter elements and should be selected for bulk capacitance, low ESR, and appropriate frequency response. Any scope measurements of PARD should be made directly at the DC/DC output pins with scope probe ground less than 0.5" in length.

Output ripple/noise (also referred to as periodic and random deviations or PARD) can be reduced below specified limits using filtering techniques, the simplest of which is the installation of additional external output capacitors. Output capacitors function as true filter elements and should be selected for bulk capacitance, low ESR, and appropriate frequency response. Any scope measurements of PARD should be made directly at the DC/DC output pins with scope probe ground less than 0.5" in length.

All external capacitors should have appropriate voltage ratings and be located as close to the converters as possible. Temperature variations for all relevant parameters should be taken into consideration.

The most effective combination of external I/O capacitors will be a function of your line voltage and source impedance, as well as your particular load and layout conditions. Our Applications Engineers can recommend potential solutions and discuss the possibility of our modifying a given device's internal filtering to meet your specific requirements. Contact our Applications Engineering Group for additional details.

Input Fusing

UNR 30-66W Series DC/DC converters are not internally fused. Certain applications and or safety agencies may require the installation of fuses at the inputs of power conversion components. Fuses should also be used if the possibility of sustained, non-current-limited, input-voltage polarity reversals exist. To allow for inrush transients, fuses should be rated for approximately 2 times the maximum input rms current.

Input Overvoltage and Reverse-Polarity Protection

UNR 30-66W Series DC/DC converters do not incorporate either input over-voltage or input reverse-polarity protection. Input voltages in excess of the listed absolute maximum ratings and input polarity reversals of longer than "instantaneous" duration can cause permanent damage to these devices.

On/Off Control

The On/Off Control pin may be used for remote on/off operation. UNR 30-66W Series DC/DC converters are designed so that they are enabled when the control pin is pulled high or left open, and disabled when the control pin is pulled low (see Performance Specifications for limits). As shown in Figure 2, all models have internal 5kΩ pull-up resistors to +Input.

Dynamic control of the on/off function is best accomplished with a mechanical relay or open-collector/open-drain drive circuit (optically isolated if appropriate). The drive circuit should be able to sink appropriate current when activated and withstand appropriate voltage when deactivated.

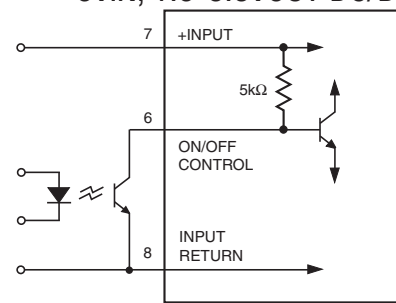

Figure 2. Driving the On/Off Control Pin

Applying an external voltage to the On/Off Control pin when no input power is applied to the converter can cause permanent damage to the converter. The on/off control function, however, is designed such that the converter can be disabled (control pin pulled low) while input power (system 5V power) is ramping up and then "released" once the input has stabilized. The time duration between the point at which the converter is released and its fully loaded output settles to within specified accuracy can be found in the Performance/Functional Specifications Table. See Start-Up Time for more details.

Start-Up Time

The V_{IN} to V_{OUT} Start-Up Time is the interval between the time at which a ramping input voltage crosses the lower limit of the specified input voltage range (4.75 Volts) and the fully loaded output voltage enters and remains within its specified accuracy band. Actual measured times will vary with input source impedance, external input capacitance, and the slew rate and final value of the input voltage as it appears to the converter.

The On/Off to V_{OUT} Start-Up Time assumes the converter is turned off via the Remote On/Off Control with the nominal input voltage already applied to the converter. The specification defines the interval between the time at which the converter is turned on and the fully loaded output voltage enters and remains within its specified accuracy band. See Typical Performance Curves for details.

Output Overvoltage Protection

UNR 30-66W Series DC/DC converters do not incorporate output overvoltage protection. In the extremely rare situation in which the device's feedback loop is broken, the output voltage may run to excessively high levels ($V_{OUT} = V_{IN}$). If it is absolutely imperative that you protect your load against any and all possible overvoltage situations, voltage limiting circuitry must be provided external to the power converter.

Output Overcurrent Detection

Overloading the output of a power converter for an extended period of time will invariably cause internal component temperatures to exceed their maximum ratings and eventually lead to component failure. High-current-carrying components such as inductors, FET's and diodes are at the highest risk. UNR 30-66W Series DC/DC converters incorporate an output overcurrent detection and shutdown function that serves to protect both the power converter and its load.

When the output current of a thermally stabilized converter exceeds the maximum rating (15A models by 20% typ., 30% max.; 20A models by 60% typ., 73% max.), the internal overcurrent detection circuit automatically shuts down the converter by discharging the soft-start circuit of the pulse width modulator (PWM). In this off state, which is similar to that achieved by pulling the On/Off Control low, the output voltage quickly drops as the output capacitors discharge into the load. Since there is no longer any output current, the overcurrent detection circuit is released, allowing the soft-start circuit to recharge and the converter to turn on again. If the faulty load condition persists, the overcurrent detection circuit will again discharge the soft-start circuit and shut down the converter. This continuous on/off cycling of the converter is referred to as "hiccup mode." Once the overload condition is removed, the converter remains on, and the output voltage is quickly restored to its regulated value.

The components used to sense the output current have large temperature coefficients. Consequently, in a "cold-start" situation, the Overcurrent Detection Point may temporarily move to 160% to 195% for 15A models and 120% to 145% for 20A models above the rated current specification. The device quickly heats up, particularly if an overload situation exists, and restores the normal Overcurrent Detection Point.

The overcurrent detection circuitry helps keep internal current levels and operating temperatures within safe operating limits. Nevertheless, sustained operation at current levels above the rated output current but below the Overcurrent Detection Point may result in permanent damage to the converter (unless active cooling keeps internal temperatures below safe limits).

Output Voltage Trimming

Trimming is accomplished with either a trimpot or a single fixed resistor. The trimpot should be connected between +Output and Output Return with its wiper connected to the Trim pin as shown in Figure 3 below.

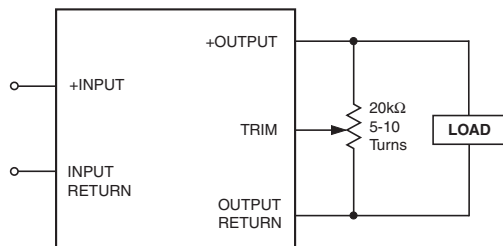
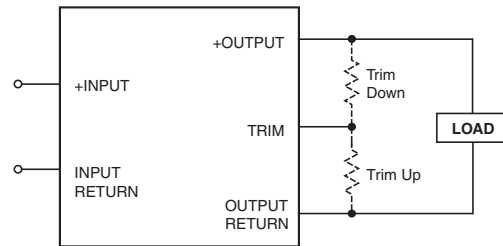

Figure 3. Trim Connections Using a Trimpot

A trimpot can be used to determine the value of a single fixed resistor which should be connected, as shown in Figure 4, between the Trim pin and +Output to trim down the output voltage, or between the Trim pin and Output Return to trim up the output voltage. Fixed resistors should be metal-film types with absolute TCR's less than 100ppm/°C to ensure stability.

The equations and look-up table below can be used as starting points for selecting specific trim-resistor values. Recall that untrimmed devices are guaranteed to be ±1% accurate.



Note: Install either a fixed trim-up resistor or a fixed trim-down resistor depending upon desired output voltage.

Figure 4. Trim Connections Using Fixed Resistors

UNR-1.5/20-D5 Trim Equations

$$R_{T_DOWN} (k\Omega) = \frac{3.83(V_O - 1.27)}{1.5 - V_O} - 1.62$$

$$R_{T_UP} (k\Omega) = \frac{4.864}{V_O - 1.5} - 1.62$$

UNR-1.8/20-D5 Trim Equations

$$R_{T_DOWN} (k\Omega) = \frac{3.83(V_O - 1.27)}{1.8 - V_O} - 1.62$$

$$R_{T_UP} (k\Omega) = \frac{4.864}{V_O - 1.8} - 1.62$$

UNR-2.5/15-D5 & UNR-2.5/20-D5 Trim Equations

$$R_{T_DOWN} (k\Omega) = \frac{7.5(V_O - 1.26)}{2.5 - V_O} - 1.62$$

$$R_{T_UP} (k\Omega) = \frac{9.45}{V_O - 2.5} - 1.62$$

UNR-3.3/15-D5 & UNR-3.3/20-D5 Trim Equations

$$R_{T_DOWN} (k\Omega) = \frac{7.5(V_O - 1.27)}{3.3 - V_O} - 1$$

$$R_{T_UP} (k\Omega) = \frac{9.495}{V_O - 3.3} - 1$$

Note: Resistor values are in kΩ. Accuracy of adjustment is subject to tolerances of resistors and factory-adjusted, initial output accuracy.
V_O = desired output voltage.

Temperature Derating

The outstanding electrical efficiency of the UNR 30-66W Series' synchronous-rectifier design and the excellent thermal conductivity of its aluminum base PCB/Heatsink construction combine to eliminate the need for supplemental forced-air cooling in the majority of routine applications. See Derating Curves.

UNR-1.5/20-D5 Efficiency vs. Load @ 25°C Ambient

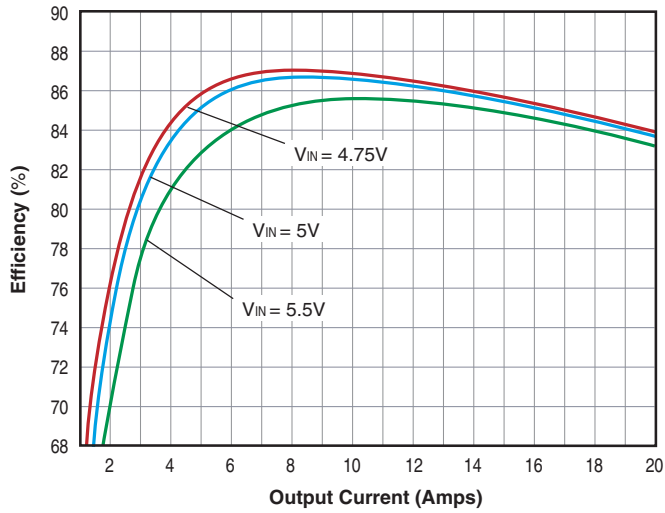

UNR-1.8/20-D5 Efficiency vs. Load @ 25°C Ambient

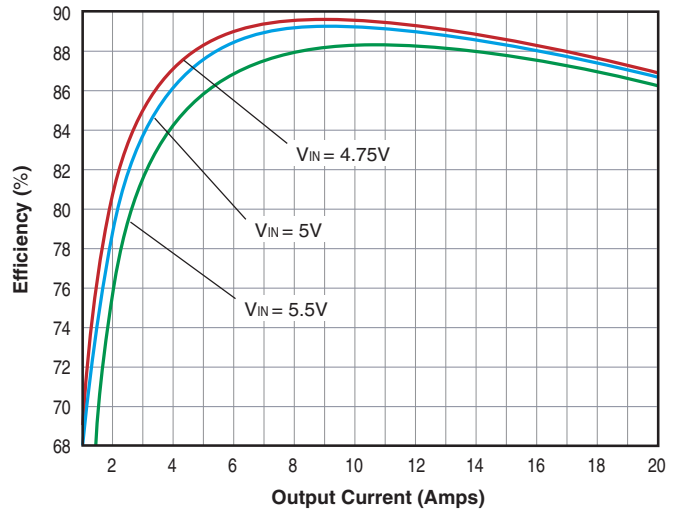

UNR-2.5/15-D5 Efficiency vs. Load @ 25°C Ambient

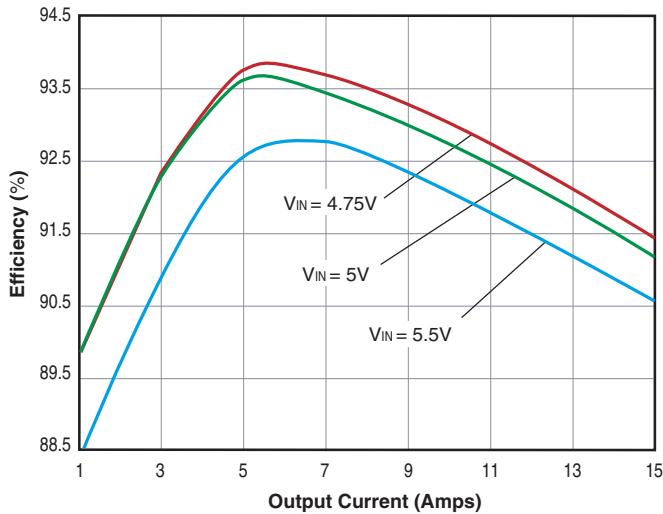

UNR-3.3/15-D5 Efficiency vs. Load @ 25°C Ambient

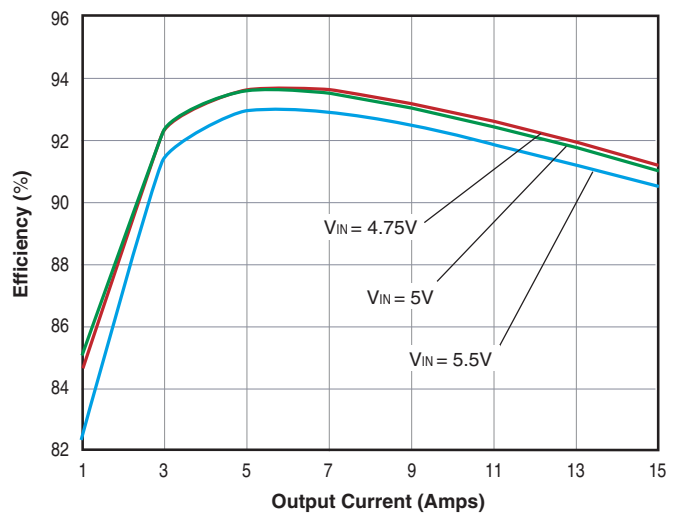

UNR-2.5/20-D5 Efficiency vs. Load @ 25°C Ambient

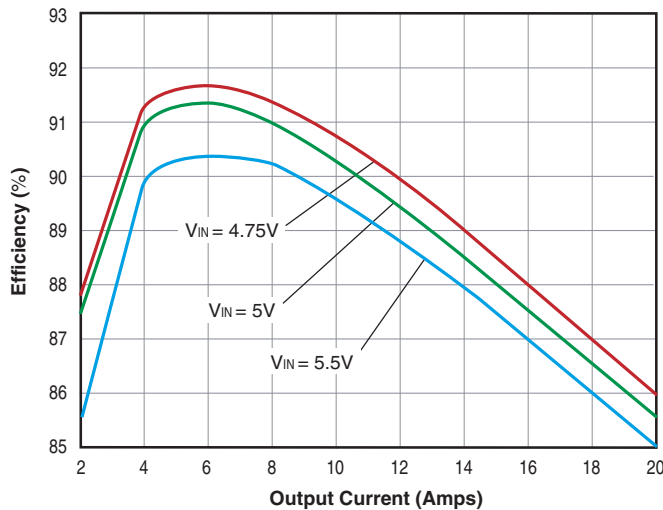

UNR-3.3/20-D5 Efficiency vs. Load @ 25°C Ambient

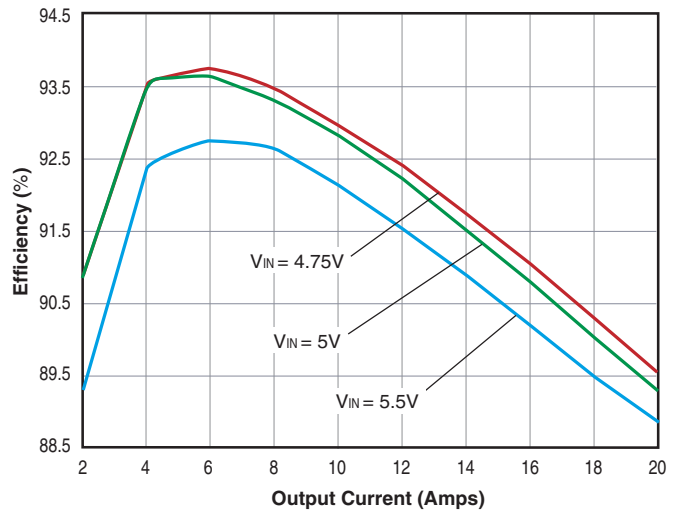

Typical Performance Curves 5VIN, 1.5-3.3VOUT DC/DC Converters

UNR-1.5/20-D5 Maximum Temperature Derating (VIN = 5V)

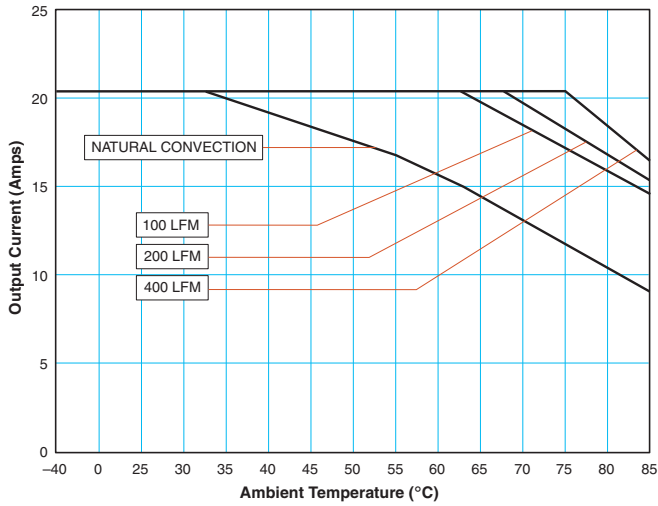

UNR-1.8/20-D5 Maximum Temperature Derating (VIN = 5V)

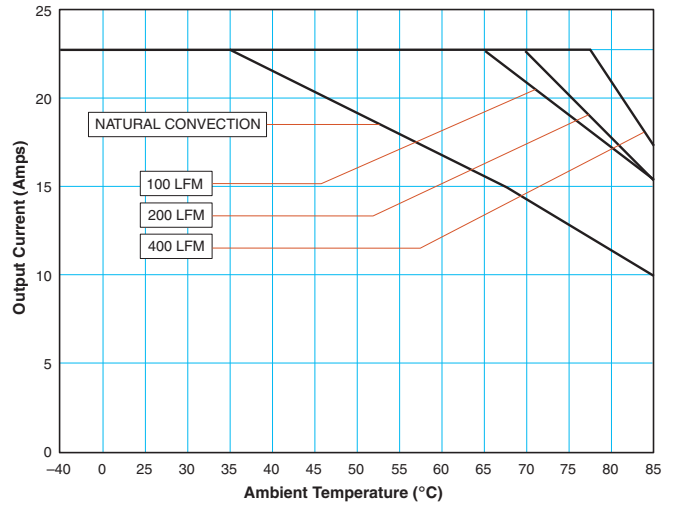

UNR-2.5/15-D5 Output Power Derating vs. Ambient Temperature

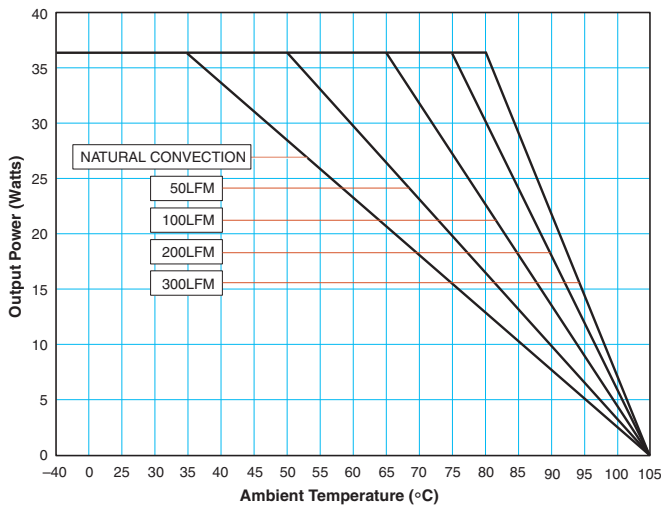

UNR-3.3/15-D5 Output Power Derating vs. Ambient Temperature

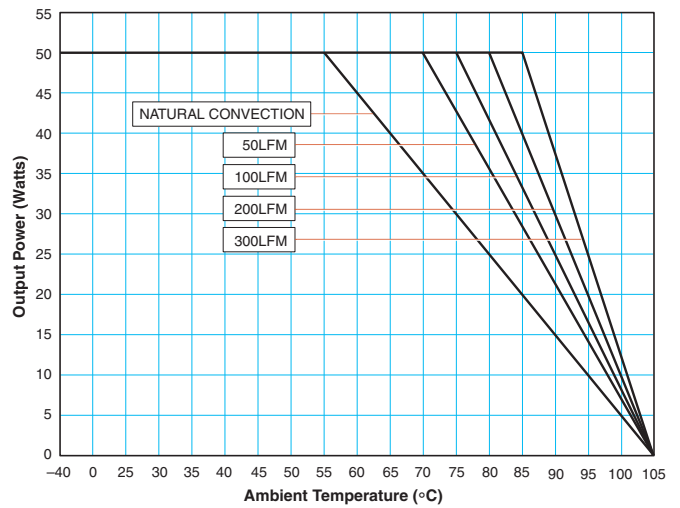

UNR-2.5/20-D5 Output Power Derating vs. Ambient Temperature

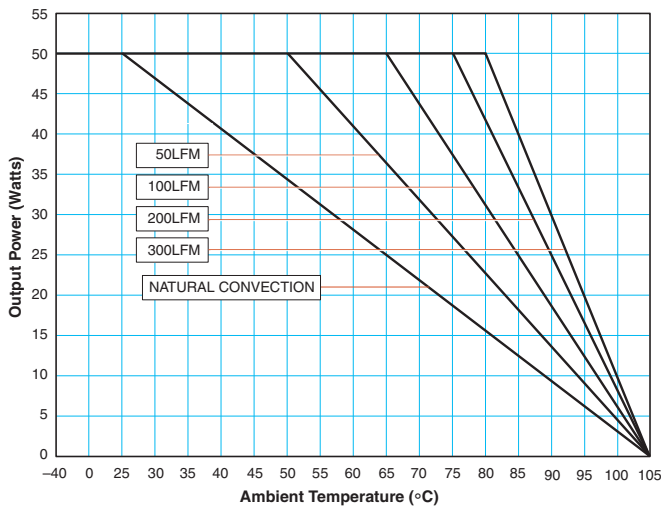

UNR-3.3/20-D5 Output Power Derating vs. Ambient Temperature

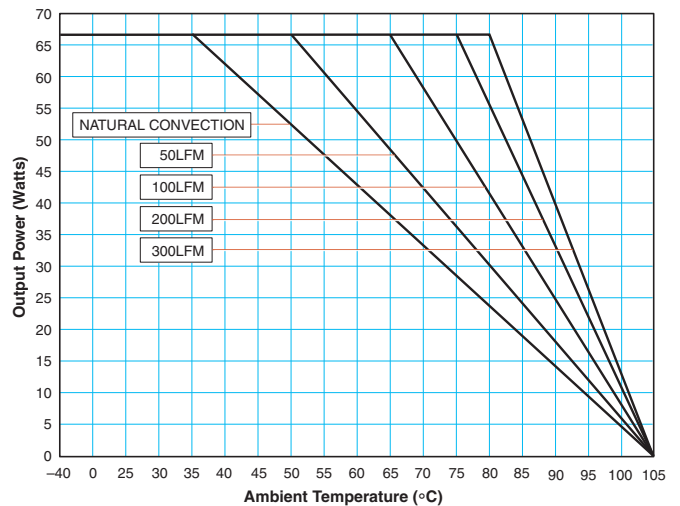

Typical Performance Curves

Start-up from VIN

(VIN = nominal, full load, external 22μF output capacitor.)

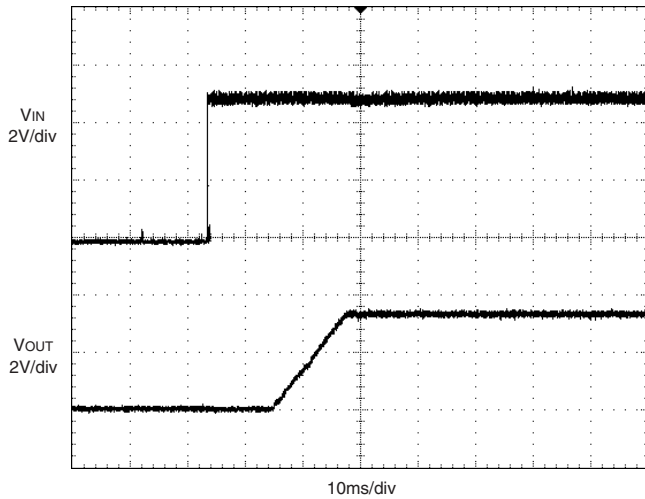

Start-up from Enable

(VIN = nominal, full load, external 22μF output capacitor.)

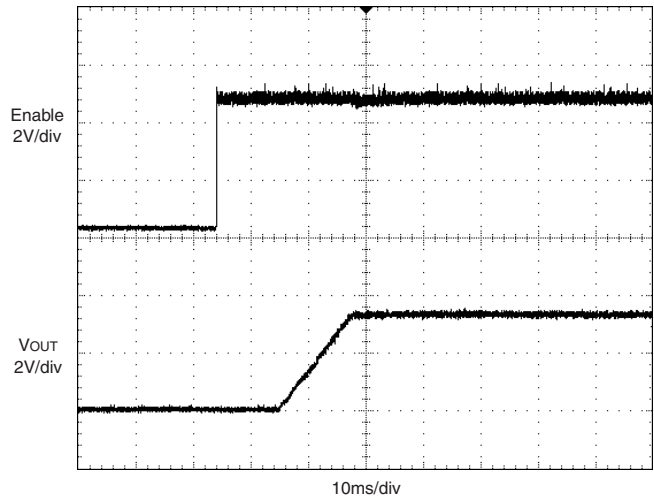

Murata Power Solutions, Inc.
 11 Cabot Boulevard, Mansfield, MA 02048-1151 U.S.A.
 ISO 9001 and 14001 REGISTERED



This product is subject to the following [operating requirements](#) and the [Life and Safety Critical Application Sales Policy](#). Refer to: <http://www.murata-ps.com/requirements/>

Murata Power Solutions, Inc. makes no representation that the use of its products in the circuits described herein, or the use of other technical information contained herein, will not infringe upon existing or future patent rights. The descriptions contained herein do not imply the granting of licenses to make, use, or sell equipment constructed in accordance therewith. Specifications are subject to change without notice. © 2013 Murata Power Solutions, Inc.

Данный компонент на территории Российской Федерации

Вы можете приобрести в компании MosChip.

Для оперативного оформления запроса Вам необходимо перейти по данной ссылке:

<http://moschip.ru/get-element>

Вы можете разместить у нас заказ для любого Вашего проекта, будь то серийное производство или разработка единичного прибора.

В нашем ассортименте представлены ведущие мировые производители активных и пассивных электронных компонентов.

Нашей специализацией является поставка электронной компонентной базы двойного назначения, продукции таких производителей как XILINX, Intel (ex.ALTERA), Vicor, Microchip, Texas Instruments, Analog Devices, Mini-Circuits, Amphenol, Glenair.

Сотрудничество с глобальными дистрибьюторами электронных компонентов, предоставляет возможность заказывать и получать с международных складов практически любой перечень компонентов в оптимальные для Вас сроки.

На всех этапах разработки и производства наши партнеры могут получить квалифицированную поддержку опытных инженеров.

Система менеджмента качества компании отвечает требованиям в соответствии с ГОСТ Р ИСО 9001, ГОСТ РВ 0015-002 и ЭС РД 009

Офис по работе с юридическими лицами:

105318, г.Москва, ул.Щербаковская д.3, офис 1107, 1118, ДЦ «Щербаковский»

Телефон: +7 495 668-12-70 (многоканальный)

Факс: +7 495 668-12-70 (доб.304)

E-mail: info@moschip.ru

Skype отдела продаж:

moschip.ru

moschip.ru_4

moschip.ru_6

moschip.ru_9