

### SIDACtor® Series - DO-214



#### Agency Approvals

AGENCY	AGENCY FILE NUMBER
	E133083

#### Pinout Designation

Not Applicable

#### Schematic Symbol



#### Description

SIDACtor® Series DO-214AA are designed to protect baseband equipment such as modems, line cards, CPE and DSL from damaging overvoltage transients.

The series provides a surface mount solution that enables equipment to comply with global regulatory standards.

#### Features and Benefits

- Low voltage overshoot
- Low on-state voltage
- Does not degrade surge capability after multiple surge events within limit.
- Fails short circuit when surged in excess of ratings
- Low capacitance

#### Applicable Global Standards

- TIA-968-A
- TIA-968-B
- ITU K.20/21 Enhanced Level\*
- ITU K.20/21 Basic Level
- GR 1089 Inter-building\*
- GR 1089 Intra-building
- IEC 61000-4-5
- YD/T 1082
- YD/T 993
- YD/T 950

\*A/B-rated parts require series resistance

#### Electrical Characteristics

Part Number	Marking	$V_{DRM}$ @ $I_{DRM}=5\mu A$	$V_S$ @ 100V/ $\mu s$	$I_H$	$I_S$	$I_T$	$V_T$ @ $I_T=2.2$ Amps	Capacitance @ 1MHz, 2V bias	
		V min	V max	mA min	mA max	A max	V max	pF min	pF max
P0080SALRP	P-8A	6	25	50	800	2.2	4	25	150
P0220SALRP	P22A	15	32	50	800	2.2	4	25	150
P0300SALRP	P03A	25	40	50	800	2.2	4	15	140
P0640SALRP	P06A	58	77	150	800	2.2	4	40	60
P0720SALRP	P07A	65	88	150	800	2.2	4	35	60
P0900SALRP	P09A	75	98	150	800	2.2	4	25	55
P1100SALRP	P11A	90	130	150	800	2.2	4	30	50
P1300SALRP	P13A	120	160	150	800	2.2	4	25	45
P1500SALRP	P15A	140	180	150	800	2.2	4	25	40
P1800SALRP	P18A	170	220	150	800	2.2	4	25	35
P2100SALRP	P21A	180	240	150	800	2.2	4	20	35
P2300SALRP	P23A	190	260	150	800	2.2	4	25	35
P2600SALRP	P26A	220	300	150	800	2.2	4	20	35
P3100SALRP	P31A	275	350	150	800	2.2	4	20	35
P3500SALRP	P35A	320	400	150	800	2.2	4	20	35
P0080SBLRP	P-8B	6	25	50	800	2.2	4	25	150
P0220SBLRP	P22B	15	32	50	800	2.2	4	25	150
P0300SBLRP	P03B	25	40	50	800	2.2	4	15	140
P0640SBLRP	P06B	58	77	150	800	2.2	4	40	80
P0720SBLRP	P07B	65	88	150	800	2.2	4	35	75

Table continues on next page.

### Electrical Parameters (continued)

Part Number	Marking	$V_{DRM}$ @ $I_{DRM}=5\mu A$	$V_S$ @ 100V/ $\mu s$	$I_H$	$I_S$	$I_T$	$V_T$ @ $I_T=2.2$ Amps	Capacitance @ 1MHz, 2V bias	
		V min	V max	mA min	mA max	A max	V max	pF min	pF max
P0900SBLRP	P09B	75	98	150	800	2.2	4	35	70
P1100SBLRP	P11B	90	130	150	800	2.2	4	30	70
P1300SBLRP	P13B	120	160	150	800	2.2	4	25	60
P1500SBLRP	P15B	140	180	150	800	2.2	4	25	55
P1800SBLRP	P18B	170	220	150	800	2.2	4	25	50
P2100SBLRP	P21B	180	240	150	800	2.2	4	20	35
P2300SBLRP	P23B	190	260	150	800	2.2	4	25	50
P2600SBLRP	P26B	220	300	150	800	2.2	4	20	45
P3100SBLRP	P31B	275	350	150	800	2.2	4	20	45
P3500SBLRP	P35B	320	400	150	800	2.2	4	20	40
P0080SCLRP	P-8C	6	25	50	800	2.2	4	45	260
P0220SCLRP	P22C	15	32	50	800	2.2	4	30	240
P0300SCLRP	P03C	25	40	50	800	2.2	4	25	250
P0640SCLRP	P06C	58	77	150	800	2.2	4	55	155
P0720SCLRP	P07C	65	88	150	800	2.2	4	50	150
P0900SCLRP	P09C	75	98	150	800	2.2	4	45	140
P1100SCLRP	P11C	90	130	150	800	2.2	4	45	115
P1300SCLRP	P13C	120	160	150	800	2.2	4	40	105
P1500SCLRP	P15C	140	180	150	800	2.2	4	35	95
P1800SCLRP	P18C	170	220	150	800	2.2	4	35	90
P2100SCLRP	P21C	180	240	150	800	2.2	4	30	90
P2300SCLRP	P23C	190	260	150	800	2.2	4	30	80
P2600SCLRP	P26C	220	300	150	800	2.2	4	30	80
P3100SCLRP	P31C	275	350	150	800	2.2	4	30	70
P3500SCLRP	P35C	320	400	150	800	2.2	4	25	65
P4500SCLRP	P45C	400	530	150	800	2.2	4	25	65

Notes:  
 - Absolute maximum ratings measured at  $T_A=25^\circ C$  (unless otherwise noted).  
 - Devices are bi-directional.

### Surge Ratings

Series	$I_{PP}$									$I_{TSM}$ 50/60 Hz	di/dt
	0.2x310 <sup>1</sup>	2x10 <sup>1</sup>	8x20 <sup>1</sup>	10x160 <sup>1</sup>	10x560 <sup>1</sup>	5x320 <sup>1</sup>	10x360 <sup>1</sup>	10x1000 <sup>1</sup>	5x310 <sup>1</sup>		
	0.5x700 <sup>2</sup>	2x10 <sup>2</sup>	1.2x50 <sup>2</sup>	10x160 <sup>2</sup>	10x560 <sup>2</sup>	9x720 <sup>2</sup>	10x360 <sup>2</sup>	10x1000 <sup>2</sup>	10x700 <sup>2</sup>		
	A min	A min	A min	A min	A min	A min	A min	A min	A min	A min	Amps/ $\mu s$ max
A	20	150	150	90	50	75	75	45	75	20	500
B	25	250	250	150	100	100	125	80	100	25	500
C	50	500	400	200	150	200	175	100	200 <sup>3</sup>	30	500

Notes:  
 1 Current waveform in  $\mu s$   
 2 Voltage waveform in  $\mu s$   
 3 For surge rating of P4500SCLRP 10x700 $\mu s$  min=150A & typical=180A  
 - Peak pulse current rating ( $I_{pp}$ ) is repetitive and guaranteed for the life of the product.  
 -  $I_{pp}$  ratings applicable over temperature range of  $-40^\circ C$  to  $+85^\circ C$   
 - The device must initially be in thermal equilibrium with  $-40^\circ C \leq T_J \leq +150^\circ C$

**Thermal Considerations**

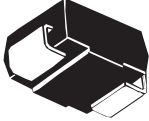
Package	Symbol	Parameter	Value	Unit
 DO-214AA	$T_J$	Operating Junction Temperature Range	-40 to +150	°C
	$T_S$	Storage Temperature Range	-65 to +150	°C
	$R_{\theta JA}$	Thermal Resistance: Junction to Ambient	90	°C/W

**V-I Characteristics**

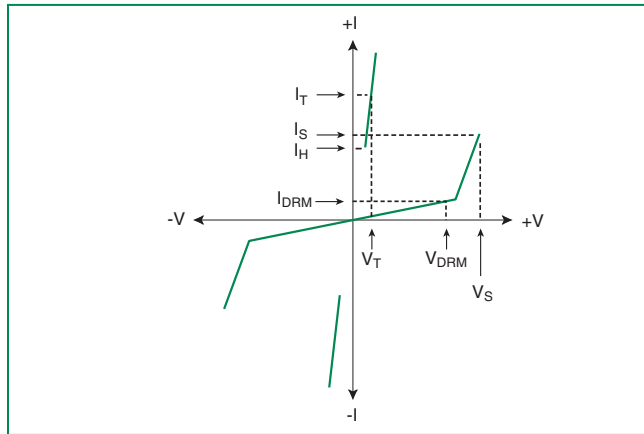

**$t_r \times t_d$  Pulse Waveform**

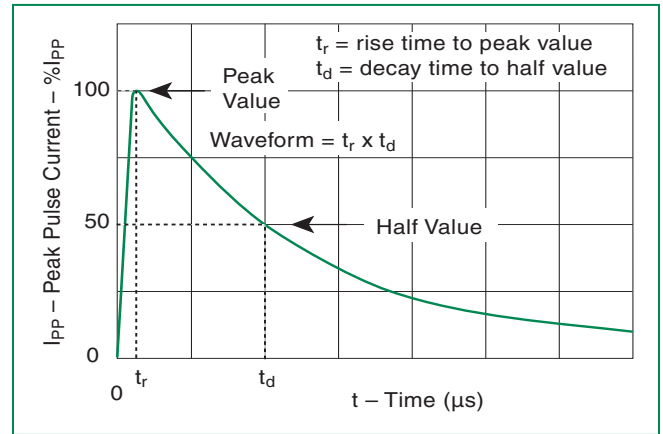

**Normalized  $V_S$  Change vs. Junction Temperature**

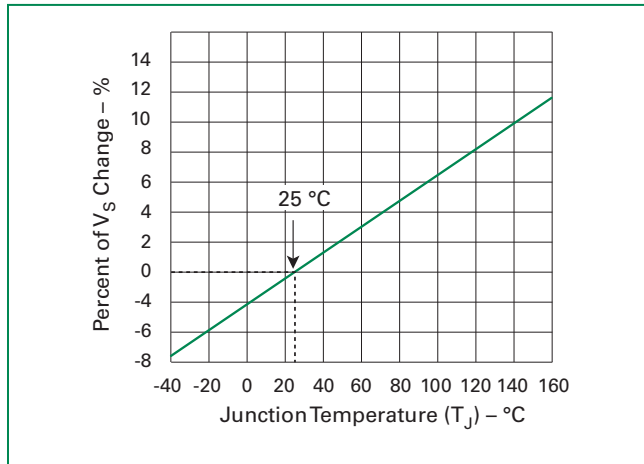

**Normalized DC Holding Current vs. Case Temperature**

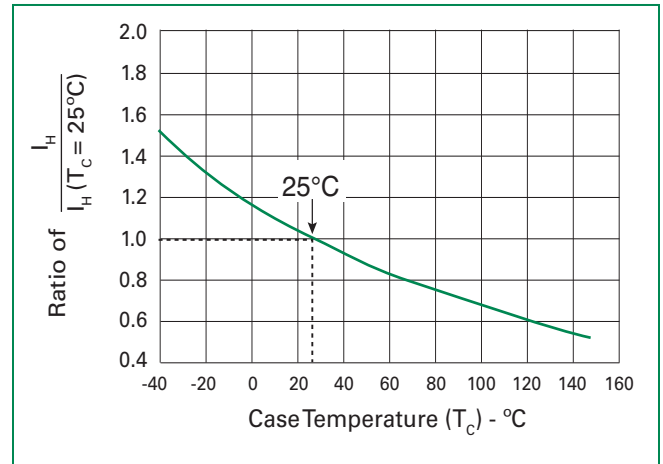

**Soldering Parameters**

Reflow Condition	Pb-Free assembly (see Fig. 1)	
Pre Heat	-Temperature Min ( $T_{s(min)}$ )	+150°C
	-Temperature Max ( $T_{s(max)}$ )	+200°C
	-Time (Min to Max) ( $t_s$ )	60-180 secs.
Average ramp up rate (LiquidusTemp ( $T_L$ ) to peak)	3°C/sec. Max.	
$T_{s(max)}$ to $T_L$ - Ramp-up Rate	3°C/sec. Max.	
Reflow	-Temperature ( $T_L$ ) (Liquidus)	+217°C
	-Temperature ( $t_L$ )	60-150 secs.
Peak Temp ( $T_p$ )	+260(+0/-5)°C	
Time within 5°C of actual PeakTemp ( $t_p$ )	30 secs. Max.	
Ramp-down Rate	6°C/sec. Max.	
Time 25°C to Peak Temp ( $T_p$ )	8 min. Max.	
Do not exceed	+260°C	

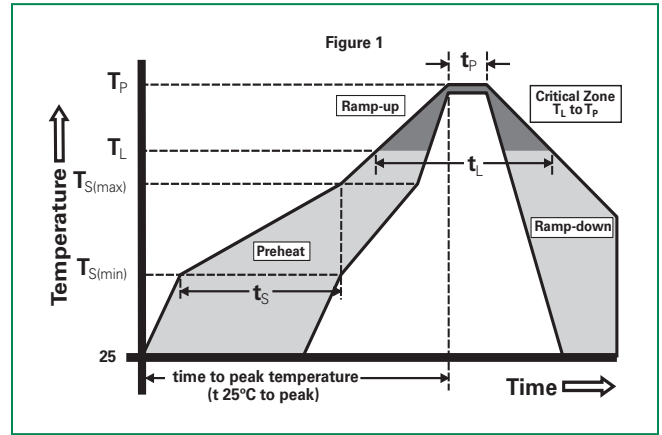

**Physical Specifications**

Lead Material	Copper Alloy
Terminal Finish	100% Matte-Tin Plated
Body Material	UL recognized epoxy meeting flammability classification 94V-0

**Environmental Specifications**

High Temp Voltage Blocking	80% Rated $V_{DRM}$ ( $V_{AC Peak}$ ) +125°C or +150°C, 504 or 1008 hrs. MIL-STD-750 (Method 1040) JEDEC, JESD22-A-101
Temp Cycling	-65°C to +150°C, 15 min. dwell, 10 up to 100 cycles. MIL-STD-750 (Method 1051) EIA/JEDEC, JESD22-A104
Biased Temp & Humidity	52 $V_{DC}$ (+85°C) 85%RH, 504 up to 1008 hrs. EIA/JEDEC, JESD22-A-101
High Temp Storage	+150°C 1008 hrs. MIL-STD-750 (Method 1031) JEDEC, JESD22-A-101
Low Temp Storage	-65°C, 1008 hrs.
Thermal Shock	0°C to +100°C, 5 min. dwell, 10 sec. transfer, 10 cycles. MIL-STD-750 (Method 1056) JEDEC, JESD22-A-106
Autoclave (Pressure Cooker Test)	+121°C, 100%RH, 2atm, 24 up to 168 hrs. EIA/JEDEC, JESD22-A-102
Resistance to Solder Heat	+260°C, 30 secs. MIL-STD-750 (Method 2031)
Moisture Sensitivity Level	85%RH, +85°C, 168 hrs., 3 reflow cycles (+260°C Peak). JEDEC-J-STD-020, Level 1

**Part Numbering**



**Part Marking**

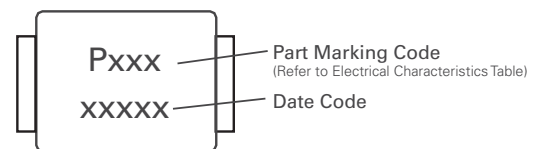

**Dimensions — DO-214AA**

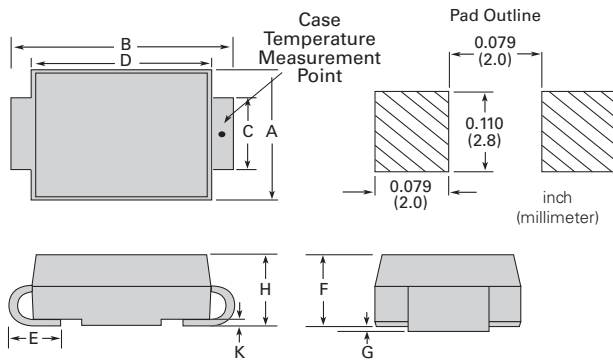

Dimensions	Inches		Millimeters	
	Min	Max	Min	Max
A	0.130	0.156	3.30	3.95
B	0.201	0.220	5.10	5.60
C	0.077	0.087	1.95	2.20
D	0.159	0.181	4.05	4.60
E	0.030	0.063	0.75	1.60
F	0.075	0.096	1.90	2.45
G	0.002	0.008	0.05	0.20
H	0.077	0.104	1.95	2.65
K	0.006	0.016	0.15	0.41

**Packing Options**

Package Type	Description	Quantity	Added Suffix	Industry Standard
S	DO-214AA Tape & Reel Pack	2500	RP	EIA-481-D

**Tape and Reel Specification — DO-214AA**

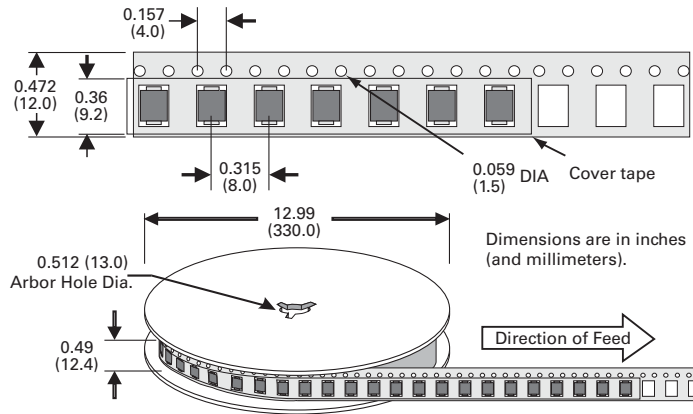

## Данный компонент на территории Российской Федерации

### Вы можете приобрести в компании MosChip.

Для оперативного оформления запроса Вам необходимо перейти по данной ссылке:

<http://moschip.ru/get-element>

Вы можете разместить у нас заказ для любого Вашего проекта, будь то серийное производство или разработка единичного прибора.

В нашем ассортименте представлены ведущие мировые производители активных и пассивных электронных компонентов.

Нашей специализацией является поставка электронной компонентной базы двойного назначения, продукции таких производителей как XILINX, Intel (ex.ALTERA), Vicor, Microchip, Texas Instruments, Analog Devices, Mini-Circuits, Amphenol, Glenair.

Сотрудничество с глобальными дистрибьюторами электронных компонентов, предоставляет возможность заказывать и получать с международных складов практически любой перечень компонентов в оптимальные для Вас сроки.

На всех этапах разработки и производства наши партнеры могут получить квалифицированную поддержку опытных инженеров.

Система менеджмента качества компании отвечает требованиям в соответствии с ГОСТ Р ИСО 9001, ГОСТ РВ 0015-002 и ЭС РД 009

### Офис по работе с юридическими лицами:

105318, г.Москва, ул.Щербаковская д.3, офис 1107, 1118, ДЦ «Щербаковский»

Телефон: +7 495 668-12-70 (многоканальный)

Факс: +7 495 668-12-70 (доб.304)

E-mail: [info@moschip.ru](mailto:info@moschip.ru)

Skype отдела продаж:

moschip.ru

moschip.ru\_4

moschip.ru\_6

moschip.ru\_9