

EconoDUAL™3 Modul mit Trench/Feldstopp IGBT4 und Emitter Controlled Diode und PressFIT / NTC  
EconoDUAL™3 module with trench/fieldstop IGBT4 and Emitter Controlled Diode and PressFIT / NTC

**Vorläufige Daten / preliminary data**

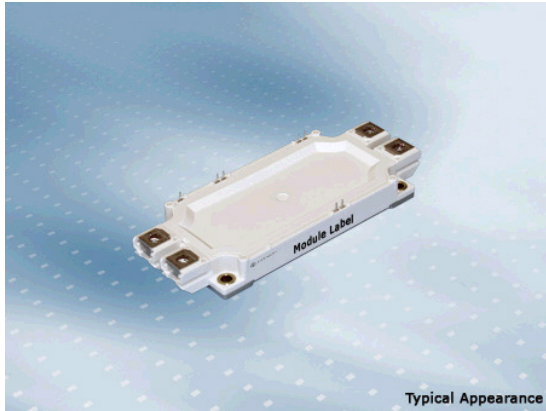

Typical Appearance

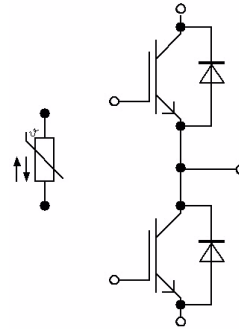

**V<sub>CEs</sub> = 1700V**  
**I<sub>C nom</sub> = 225A / I<sub>CRM</sub> = 450A**

**Typische Anwendungen**

- Motorantriebe
- Servoumrichter
- USV-Systeme
- Windgeneratoren

**Typical Applications**

- Motor Drives
- Servo Drives
- UPS Systems
- Wind Turbines

**Elektrische Eigenschaften**

- Niedriges V<sub>CEsat</sub>
- T<sub>vj op</sub> = 150°C

**Electrical Features**

- Low V<sub>CEsat</sub>
- T<sub>vj op</sub> = 150°C

**Mechanische Eigenschaften**

- Standardgehäuse

**Mechanical Features**

- Standard Housing

**Module Label Code**

**Barcode Code 128**



**DMX - Code**



**Content of the Code**

Content of the Code	Digit
Module Serial Number	1 - 5
Module Material Number	6 - 11
Production Order Number	12 - 19
Datecode (Production Year)	20 - 21
Datecode (Production Week)	22 - 23

prepared by: MB	date of publication: 2011-04-19	material no: 33983
approved by: MK	revision: 2.0	

**Vorläufige Daten**  
**preliminary data**

**IGBT-Wechselrichter / IGBT-inverter**

**Höchstzulässige Werte / maximum rated values**

Kollektor-Emitter-Sperrspannung collector-emitter voltage	$T_{vj} = 25^{\circ}\text{C}$	$V_{CES}$	1700	V
Kollektor-Dauergleichstrom DC-collector current	$T_C = 100^{\circ}\text{C}, T_{vj} = 175^{\circ}\text{C}$ $T_C = 25^{\circ}\text{C}, T_{vj} = 175^{\circ}\text{C}$	$I_{C\text{ nom}}$ $I_C$	225 340	A A
Periodischer Kollektor Spitzenstrom repetitive peak collector current	$t_p = 1\text{ ms}$	$I_{CRM}$	450	A
Gesamt-Verlustleistung total power dissipation	$T_C = 25^{\circ}\text{C}, T_{vj} = 175^{\circ}\text{C}$	$P_{tot}$	1500	W
Gate-Emitter-Spitzenspannung gate-emitter peak voltage		$V_{GES}$	+/-20	V

**Charakteristische Werte / characteristic values**

			min.	typ.	max.		
Kollektor-Emitter Sättigungsspannung collector-emitter saturation voltage	$I_C = 225\text{ A}, V_{GE} = 15\text{ V}$ $I_C = 225\text{ A}, V_{GE} = 15\text{ V}$ $I_C = 225\text{ A}, V_{GE} = 15\text{ V}$	$T_{vj} = 25^{\circ}\text{C}$ $T_{vj} = 125^{\circ}\text{C}$ $T_{vj} = 150^{\circ}\text{C}$	$V_{CE\text{ sat}}$	1,95 2,35 2,45	2,30	V V V	
Gate-Schwellenspannung gate threshold voltage	$I_C = 9,00\text{ mA}, V_{CE} = V_{GE}, T_{vj} = 25^{\circ}\text{C}$		$V_{GEth}$	5,2	5,8	6,4	V
Gateladung gate charge	$V_{GE} = -15\text{ V} \dots +15\text{ V}$		$Q_G$	2,35			$\mu\text{C}$
Interner Gatewiderstand internal gate resistor	$T_{vj} = 25^{\circ}\text{C}$		$R_{Gint}$	2,8			$\Omega$
Eingangskapazität input capacitance	$f = 1\text{ MHz}, T_{vj} = 25^{\circ}\text{C}, V_{CE} = 25\text{ V}, V_{GE} = 0\text{ V}$		$C_{ies}$	18,5			nF
Rückwirkungskapazität reverse transfer capacitance	$f = 1\text{ MHz}, T_{vj} = 25^{\circ}\text{C}, V_{CE} = 25\text{ V}, V_{GE} = 0\text{ V}$		$C_{res}$	0,60			nF
Kollektor-Emitter Reststrom collector-emitter cut-off current	$V_{CE} = 1700\text{ V}, V_{GE} = 0\text{ V}, T_{vj} = 25^{\circ}\text{C}$		$I_{CES}$			3,0	mA
Gate-Emitter Reststrom gate-emitter leakage current	$V_{CE} = 0\text{ V}, V_{GE} = 20\text{ V}, T_{vj} = 25^{\circ}\text{C}$		$I_{GES}$			400	nA
Einschaltverzögerungszeit (ind. Last) turn-on delay time (inductive load)	$I_C = 225\text{ A}, V_{CE} = 900\text{ V}$ $V_{GE} = \pm 15\text{ V}$ $R_{Gon} = 3,3\ \Omega$	$T_{vj} = 25^{\circ}\text{C}$ $T_{vj} = 125^{\circ}\text{C}$ $T_{vj} = 150^{\circ}\text{C}$	$t_{d\text{ on}}$	0,22 0,25 0,26			$\mu\text{s}$ $\mu\text{s}$ $\mu\text{s}$
Anstiegszeit (induktive Last) rise time (inductive load)	$I_C = 225\text{ A}, V_{CE} = 900\text{ V}$ $V_{GE} = \pm 15\text{ V}$ $R_{Gon} = 3,3\ \Omega$	$T_{vj} = 25^{\circ}\text{C}$ $T_{vj} = 125^{\circ}\text{C}$ $T_{vj} = 150^{\circ}\text{C}$	$t_r$	0,08 0,085 0,09			$\mu\text{s}$ $\mu\text{s}$ $\mu\text{s}$
Abschaltverzögerungszeit (ind. Last) turn-off delay time (inductive load)	$I_C = 225\text{ A}, V_{CE} = 900\text{ V}$ $V_{GE} = \pm 15\text{ V}$ $R_{Goff} = 6,2\ \Omega$	$T_{vj} = 25^{\circ}\text{C}$ $T_{vj} = 125^{\circ}\text{C}$ $T_{vj} = 150^{\circ}\text{C}$	$t_{d\text{ off}}$	0,69 0,84 0,88			$\mu\text{s}$ $\mu\text{s}$ $\mu\text{s}$
Fallzeit (induktive Last) fall time (inductive load)	$I_C = 225\text{ A}, V_{CE} = 900\text{ V}$ $V_{GE} = \pm 15\text{ V}$ $R_{Goff} = 6,2\ \Omega$	$T_{vj} = 25^{\circ}\text{C}$ $T_{vj} = 125^{\circ}\text{C}$ $T_{vj} = 150^{\circ}\text{C}$	$t_f$	0,28 0,54 0,62			$\mu\text{s}$ $\mu\text{s}$ $\mu\text{s}$
Einschaltverlustenergie pro Puls turn-on energy loss per pulse	$I_C = 225\text{ A}, V_{CE} = 900\text{ V}, L_S = 80\text{ nH}$ $V_{GE} = \pm 15\text{ V}, di/dt = 3100\text{ A}/\mu\text{s} (T_{vj}=150^{\circ}\text{C})$ $R_{Gon} = 3,3\ \Omega$	$T_{vj} = 25^{\circ}\text{C}$ $T_{vj} = 125^{\circ}\text{C}$ $T_{vj} = 150^{\circ}\text{C}$	$E_{on}$	51,0 67,5 72,0			mJ mJ mJ
Abschaltverlustenergie pro Puls turn-off energy loss per pulse	$I_C = 225\text{ A}, V_{CE} = 900\text{ V}, L_S = 80\text{ nH}$ $V_{GE} = \pm 15\text{ V}, du/dt = 3000\text{ V}/\mu\text{s} (T_{vj}=150^{\circ}\text{C})$ $R_{Goff} = 6,2\ \Omega$	$T_{vj} = 25^{\circ}\text{C}$ $T_{vj} = 125^{\circ}\text{C}$ $T_{vj} = 150^{\circ}\text{C}$	$E_{off}$	45,5 73,5 83,5			mJ mJ mJ
Kurzschlussverhalten SC data	$V_{GE} \leq 15\text{ V}, V_{CC} = 1000\text{ V}$ $V_{CEmax} = V_{CES} - L_{sCE} \cdot di/dt$	$t_p \leq 10\ \mu\text{s}, T_{vj} = 150^{\circ}\text{C}$	$I_{SC}$	1100			A
Innerer Wärmewiderstand thermal resistance, junction to case	pro IGBT / per IGBT		$R_{thJC}$			0,099	K/W
Übergangs-Wärmewiderstand thermal resistance, case to heatsink	pro IGBT / per IGBT $\lambda_{Paste} = 1\text{ W}/(\text{m}\cdot\text{K}) / \lambda_{grease} = 1\text{ W}/(\text{m}\cdot\text{K})$		$R_{thCH}$	0,029			K/W

prepared by: MB	date of publication: 2011-04-19
approved by: MK	revision: 2.0



**Vorläufige Daten**  
**preliminary data**

**Diode-Wechselrichter / diode-inverter**

**Höchstzulässige Werte / maximum rated values**

Periodische Spitzensperrspannung repetitive peak reverse voltage	$T_{vj} = 25^{\circ}\text{C}$	$V_{RRM}$	1700	V
Dauergleichstrom DC forward current		$I_F$	225	A
Periodischer Spitzenstrom repetitive peak forward current	$t_p = 1 \text{ ms}$	$I_{FRM}$	450	A
Grenzlastintegral $I^2t$ - value	$V_R = 0 \text{ V}, t_p = 10 \text{ ms}, T_{vj} = 125^{\circ}\text{C}$	$I^2t$	8300	$\text{A}^2\text{s}$

**Charakteristische Werte / characteristic values**

			min.	typ.	max.	
Durchlassspannung forward voltage	$I_F = 225 \text{ A}, V_{GE} = 0 \text{ V}$ $I_F = 225 \text{ A}, V_{GE} = 0 \text{ V}$ $I_F = 225 \text{ A}, V_{GE} = 0 \text{ V}$	$T_{vj} = 25^{\circ}\text{C}$ $T_{vj} = 125^{\circ}\text{C}$ $T_{vj} = 150^{\circ}\text{C}$	$V_F$	1,80 1,90 1,95	2,20	V V V
Rückstromspitze peak reverse recovery current	$I_F = 225 \text{ A}, -di_F/dt = 3100 \text{ A}/\mu\text{s} (T_{vj}=150^{\circ}\text{C})$ $V_R = 900 \text{ V}$ $V_{GE} = -15 \text{ V}$	$T_{vj} = 25^{\circ}\text{C}$ $T_{vj} = 125^{\circ}\text{C}$ $T_{vj} = 150^{\circ}\text{C}$	$I_{RM}$	320 375 385		A A A
Sperrverzögerungsladung recovered charge	$I_F = 225 \text{ A}, -di_F/dt = 3100 \text{ A}/\mu\text{s} (T_{vj}=150^{\circ}\text{C})$ $V_R = 900 \text{ V}$ $V_{GE} = -15 \text{ V}$	$T_{vj} = 25^{\circ}\text{C}$ $T_{vj} = 125^{\circ}\text{C}$ $T_{vj} = 150^{\circ}\text{C}$	$Q_r$	57,0 97,0 110		$\mu\text{C}$ $\mu\text{C}$ $\mu\text{C}$
Abschaltenergie pro Puls reverse recovery energy	$I_F = 225 \text{ A}, -di_F/dt = 3100 \text{ A}/\mu\text{s} (T_{vj}=150^{\circ}\text{C})$ $V_R = 900 \text{ V}$ $V_{GE} = -15 \text{ V}$	$T_{vj} = 25^{\circ}\text{C}$ $T_{vj} = 125^{\circ}\text{C}$ $T_{vj} = 150^{\circ}\text{C}$	$E_{rec}$	32,5 60,5 69,0		mJ mJ mJ
Innerer Wärmewiderstand thermal resistance, junction to case	pro Diode / per diode		$R_{thJC}$		0,16	K/W
Übergangs-Wärmewiderstand thermal resistance, case to heatsink	pro Diode / per diode $\lambda_{\text{Paste}} = 1 \text{ W}/(\text{m}\cdot\text{K}) / \lambda_{\text{grease}} = 1 \text{ W}/(\text{m}\cdot\text{K})$		$R_{thCH}$	0,047		K/W

**NTC-Widerstand / NTC-thermistor**

**Charakteristische Werte / characteristic values**

			min.	typ.	max.	
Nennwiderstand rated resistance	$T_C = 25^{\circ}\text{C}$		$R_{25}$	5,00		k $\Omega$
Abweichung von $R_{100}$ deviation of $R_{100}$	$T_C = 100^{\circ}\text{C}, R_{100} = 493 \Omega$		$\Delta R/R$	-5	5	%
Verlustleistung power dissipation	$T_C = 25^{\circ}\text{C}$		$P_{25}$		20,0	mW
B-Wert B-value	$R_2 = R_{25} \exp [B_{25/50}(1/T_2 - 1/(298,15 \text{ K}))]$		$B_{25/50}$	3375		K
B-Wert B-value	$R_2 = R_{25} \exp [B_{25/80}(1/T_2 - 1/(298,15 \text{ K}))]$		$B_{25/80}$	3411		K
B-Wert B-value	$R_2 = R_{25} \exp [B_{25/100}(1/T_2 - 1/(298,15 \text{ K}))]$		$B_{25/100}$	3433		K

Angaben gemäß gültiger Application Note.  
Specification according to the valid application note.

prepared by: MB	date of publication: 2011-04-19
approved by: MK	revision: 2.0



**Vorläufige Daten**  
**preliminary data**

**Modul / module**

Isolations-Prüfspannung insulation test voltage	RMS, f = 50 Hz, t = 1 min.	V <sub>ISOL</sub>	3,4		kV
Material Modulgrundplatte material of module baseplate			Cu		
Material für innere Isolation material for internal insulation			Al <sub>2</sub> O <sub>3</sub>		
Kriechstrecke creepage distance	Kontakt - Kühlkörper / terminal to heatsink Kontakt - Kontakt / terminal to terminal		14,5 13,0		mm
Luftstrecke clearance distance	Kontakt - Kühlkörper / terminal to heatsink Kontakt - Kontakt / terminal to terminal		12,5 10,0		mm
Vergleichszahl der Kriechwegbildung comparative tracking index		CTI	> 200		
			min.	typ.	max.
Übergangs-Wärmewiderstand thermal resistance, case to heatsink	pro Modul / per module $\lambda_{\text{Paste}} = 1 \text{ W}/(\text{m}\cdot\text{K}) / \lambda_{\text{grease}} = 1 \text{ W}/(\text{m}\cdot\text{K})$	R <sub>thCH</sub>	0,009		K/W
Modulinduktivität stray inductance module		L <sub>sCE</sub>	20		nH
Modulleitungswiderstand, Anschlüsse - Chip module lead resistance, terminals - chip	T <sub>C</sub> = 25°C, pro Schalter / per switch	R <sub>CC'+EE'</sub>	1,10		mΩ
Höchstzulässige Sperrschichttemperatur maximum junction temperature	Wechselrichter, Brems-Chopper / Inverter, Brake-Chopper	T <sub>vj max</sub>			175 °C
Temperatur im Schaltbetrieb temperature under switching conditions	Wechselrichter, Brems-Chopper / Inverter, Brake-Chopper	T <sub>vj op</sub>	-40		150 °C
Lagertemperatur storage temperature		T <sub>stg</sub>	-40		150 °C
Anzugsdrehmoment f. mech. Befestigung mounting torque	Schraube M5 - Montage gem. gültiger Applikation Note screw M5 - mounting according to valid application note	M	3,00	-	6,00 Nm
Anzugsdrehmoment f. elektr. Anschlüsse terminal connection torque	Schraube M6 - Montage gem. gültiger Applikation Note screw M6 - mounting according to valid application note	M	3,0	-	6,0 Nm
Gewicht weight		G		345	g

prepared by: MB	date of publication: 2011-04-19
approved by: MK	revision: 2.0



**Vorläufige Daten**  
**preliminary data**

**Ausgangskennlinie IGBT-Wechselr. (typisch)**  
**output characteristic IGBT-inverter (typical)**  
 $I_c = f(V_{CE})$   
 $V_{GE} = 15\text{ V}$

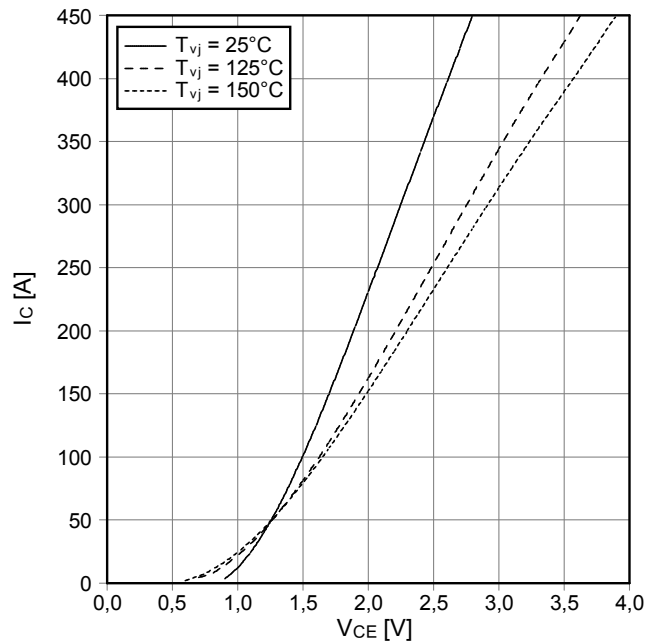

**Ausgangskennlinienfeld IGBT-Wechselr. (typisch)**  
**output characteristic IGBT-inverter (typical)**  
 $I_c = f(V_{CE})$   
 $T_{vj} = 150^\circ\text{C}$

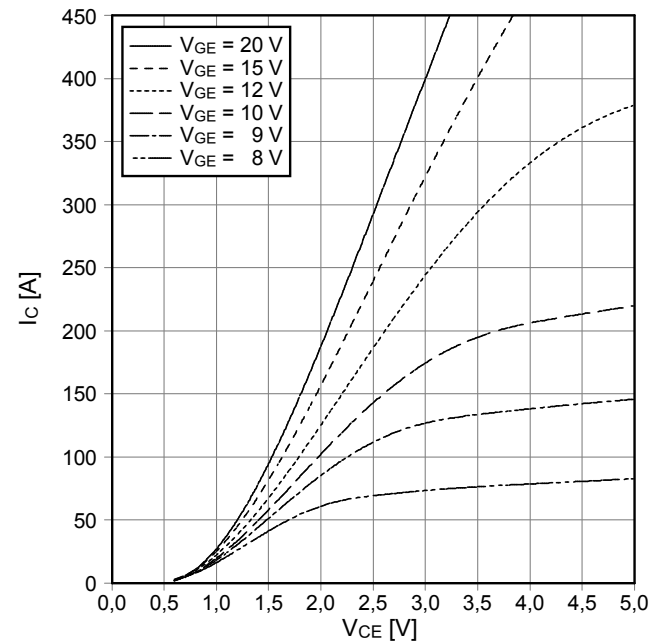

**Übertragungscharakteristik IGBT-Wechselr. (typisch)**  
**transfer characteristic IGBT-inverter (typical)**  
 $I_c = f(V_{GE})$   
 $V_{CE} = 20\text{ V}$

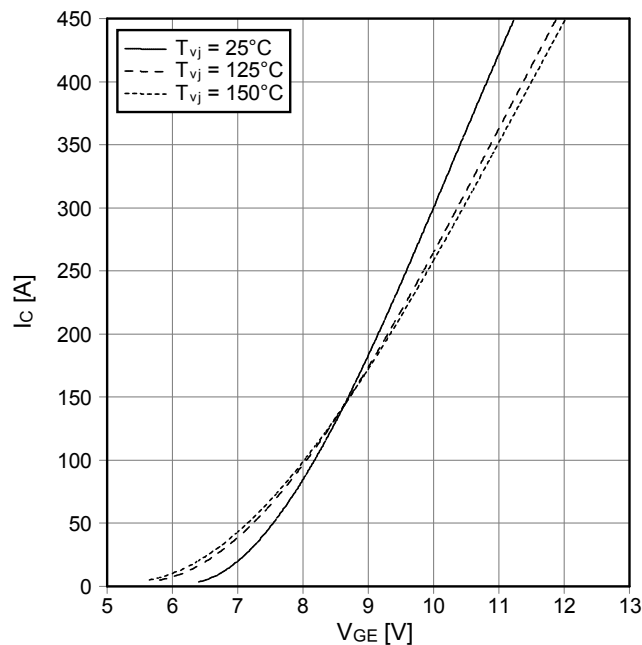

**Schaltverluste IGBT-Wechselr. (typisch)**  
**switching losses IGBT-inverter (typical)**  
 $E_{on} = f(I_c), E_{off} = f(I_c)$   
 $V_{GE} = \pm 15\text{ V}, R_{Gon} = 3.3\ \Omega, R_{Goff} = 6.2\ \Omega, V_{CE} = 900\text{ V}$

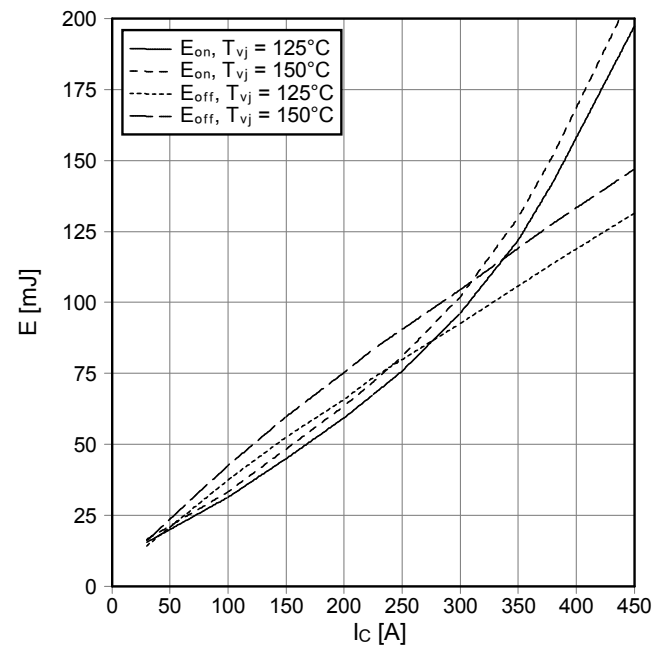

prepared by: MB	date of publication: 2011-04-19
approved by: MK	revision: 2.0



Vorläufige Daten  
preliminary data

Schaltverluste IGBT-Wechselr. (typisch)  
switching losses IGBT-inverter (typical)  
 $E_{on} = f(R_G)$ ,  $E_{off} = f(R_G)$   
 $V_{GE} = \pm 15\text{ V}$ ,  $I_C = 225\text{ A}$ ,  $V_{CE} = 900\text{ V}$

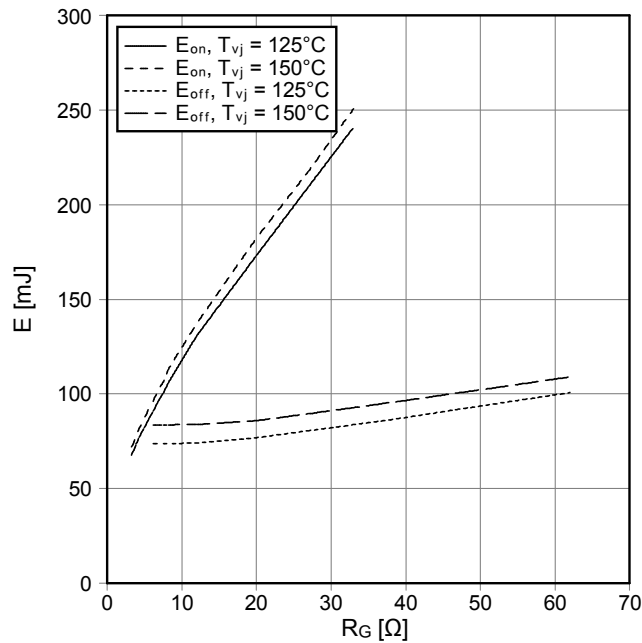

Transienter Wärmewiderstand IGBT-Wechselr.  
transient thermal impedance IGBT-inverter  
 $Z_{thJC} = f(t)$

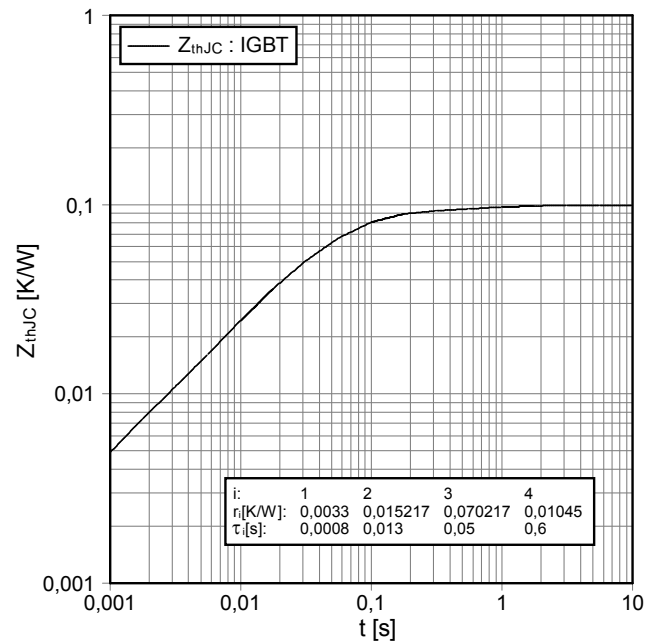

Sicherer Rückwärts-Arbeitsbereich IGBT-Wr. (RBSOA)  
reverse bias safe operating area IGBT-inv. (RBSOA)  
 $I_C = f(V_{CE})$   
 $V_{GE} = \pm 15\text{ V}$ ,  $R_{Goff} = 6.2\ \Omega$ ,  $T_{vj} = 150^\circ\text{C}$

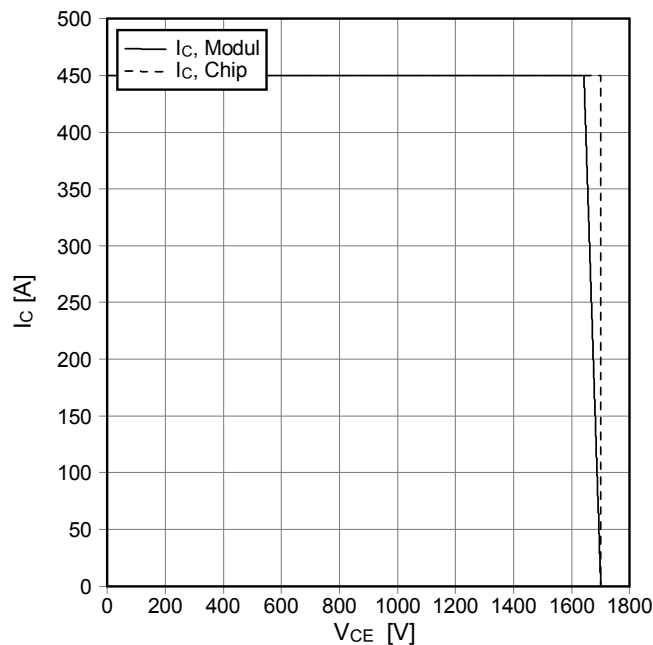

Durchlasskennlinie der Diode-Wechselr. (typisch)  
forward characteristic of diode-inverter (typical)  
 $I_F = f(V_F)$

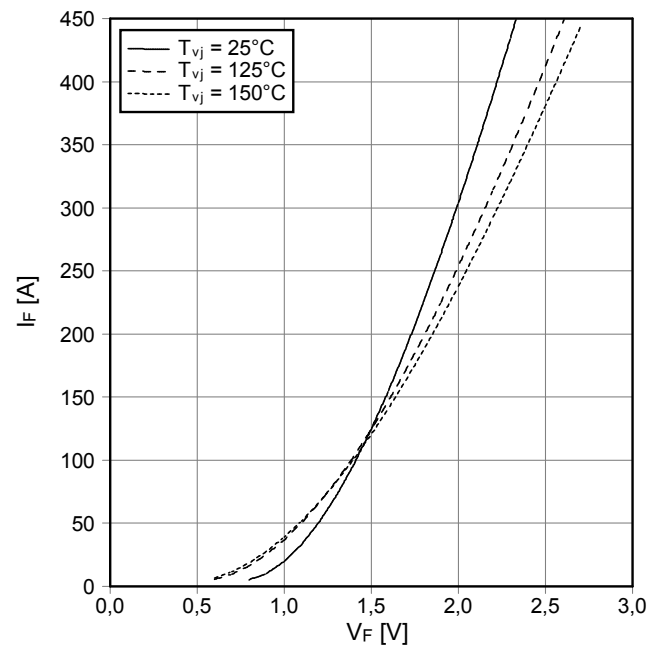

prepared by: MB	date of publication: 2011-04-19
approved by: MK	revision: 2.0



Vorläufige Daten  
preliminary data

Schaltverluste Diode-Wechselr. (typisch)  
switching losses diode-inverter (typical)

$E_{rec} = f(I_F)$   
 $R_{Gon} = 3.3 \Omega$ ,  $V_{CE} = 900 V$

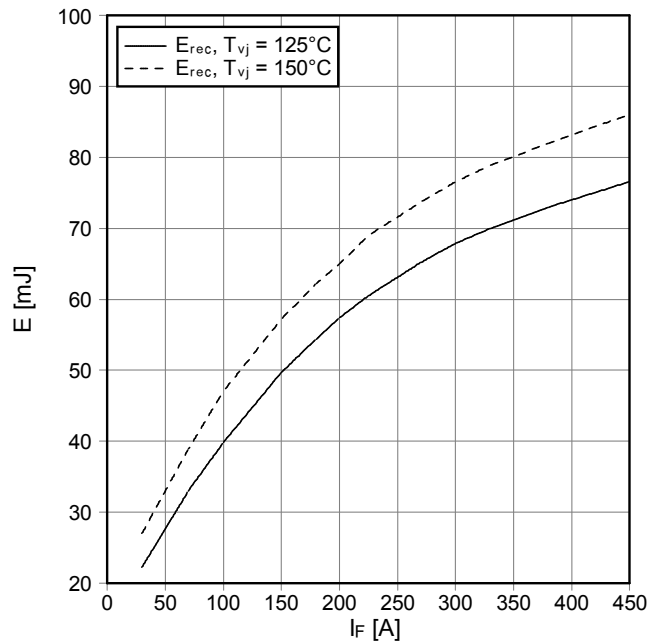

Schaltverluste Diode-Wechselr. (typisch)  
switching losses diode-inverter (typical)

$E_{rec} = f(R_G)$   
 $I_F = 225 A$ ,  $V_{CE} = 900 V$

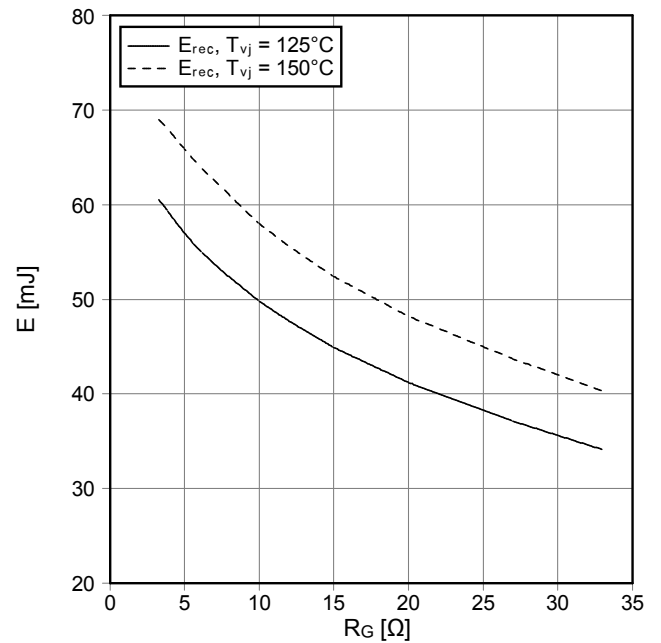

Transienter Wärmewiderstand Diode-Wechselr.  
transient thermal impedance diode-inverter

$Z_{thJC} = f(t)$

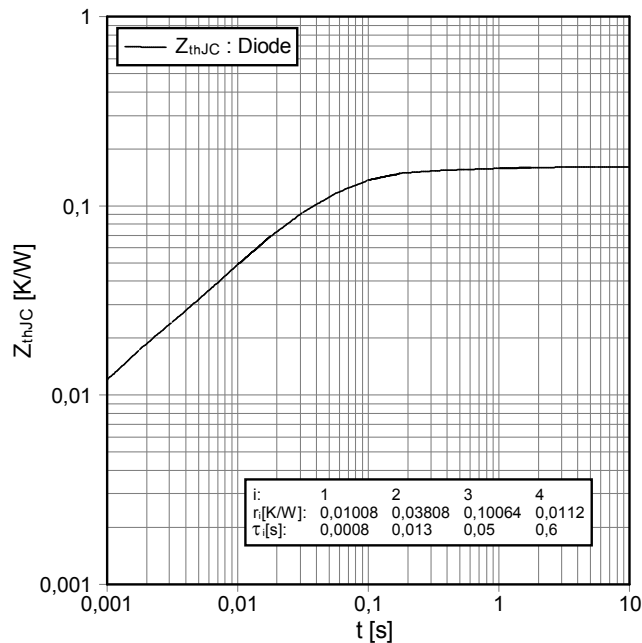

NTC-Temperaturkennlinie (typisch)  
NTC-temperature characteristic (typical)

$R = f(T)$



prepared by: MB	date of publication: 2011-04-19
approved by: MK	revision: 2.0

Schaltplan / circuit diagram

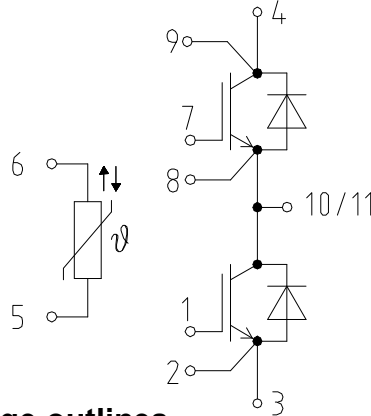

Gehäuseabmessungen / package outlines

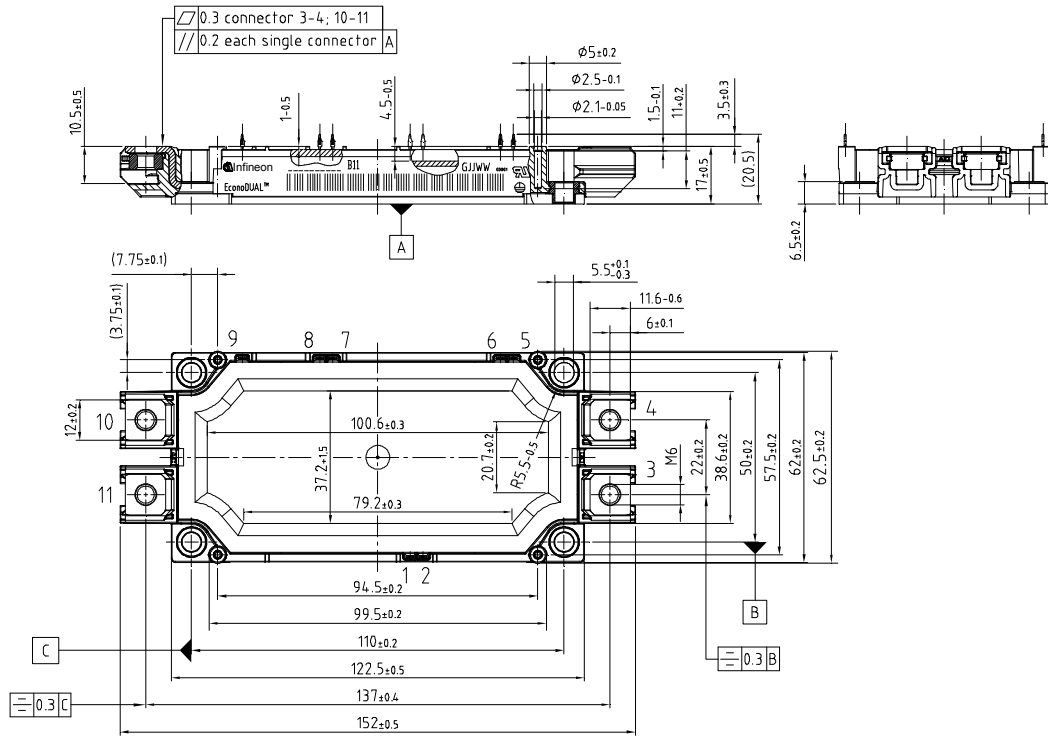

Leiterplatten-Lochbild / PCB drillhole pattern

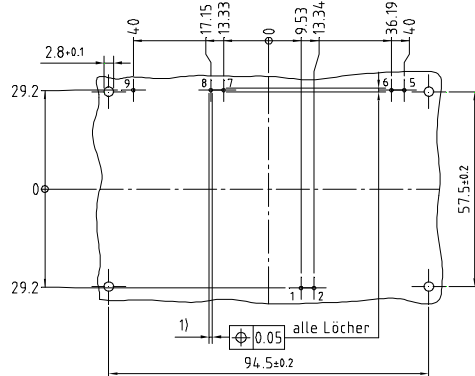

- 1)  $\phi 1^{+0.09}_{-0.06}$  Durchmesser des metallierten Loches
- $\phi 1^{+0.09}_{-0.06}$  Diameter of finished plated-through hole
- $\phi 1.15$  Bohrungsdurchmesser des Loches
- $\phi 1.15$  Diameter of drilled hole

prepared by: MB  
approved by: MK

date of publication: 2011-04-19  
revision: 2.0





**Vorläufige Daten  
preliminary data**

**Nutzungsbedingungen**

Die in diesem Produktdatenblatt enthaltenen Daten sind ausschließlich für technisch geschultes Fachpersonal bestimmt. Die Beurteilung der Eignung dieses Produktes für Ihre Anwendung sowie die Beurteilung der Vollständigkeit der bereitgestellten Produktdaten für diese Anwendung obliegt Ihnen bzw. Ihren technischen Abteilungen.

In diesem Produktdatenblatt werden diejenigen Merkmale beschrieben, für die wir eine liefervertragliche Gewährleistung übernehmen. Eine solche Gewährleistung richtet sich ausschließlich nach Maßgabe der im jeweiligen Liefervertrag enthaltenen Bestimmungen. Garantien jeglicher Art werden für das Produkt und dessen Eigenschaften keinesfalls übernommen.

Sollten Sie von uns Produktinformationen benötigen, die über den Inhalt dieses Produktdatenblatts hinausgehen und insbesondere eine spezifische Verwendung und den Einsatz dieses Produktes betreffen, setzen Sie sich bitte mit dem für Sie zuständigen Vertriebsbüro in Verbindung (siehe [www.infineon.com](http://www.infineon.com), Vertrieb&Kontakt). Für Interessenten halten wir Application Notes bereit.

Aufgrund der technischen Anforderungen könnte unser Produkt gesundheitsgefährdende Substanzen enthalten. Bei Rückfragen zu den in diesem Produkt jeweils enthaltenen Substanzen setzen Sie sich bitte ebenfalls mit dem für Sie zuständigen Vertriebsbüro in Verbindung.

Sollten Sie beabsichtigen, das Produkt in Anwendungen der Luftfahrt, in gesundheits- oder lebensgefährdenden oder lebenserhaltenden Anwendungsbereichen einzusetzen, bitten wir um Mitteilung. Wir weisen darauf hin, dass wir für diese Fälle

- die gemeinsame Durchführung eines Risiko- und Qualitätsassessments;
- den Abschluss von speziellen Qualitätssicherungsvereinbarungen;
- die gemeinsame Einführung von Maßnahmen zu einer laufenden Produktbeobachtung dringend empfehlen und gegebenenfalls die Belieferung von der Umsetzung solcher Maßnahmen abhängig machen.

Soweit erforderlich, bitten wir Sie, entsprechende Hinweise an Ihre Kunden zu geben.

Inhaltliche Änderungen dieses Produktdatenblatts bleiben vorbehalten.

**Terms & Conditions of usage**

The data contained in this product data sheet is exclusively intended for technically trained staff. You and your technical departments will have to evaluate the suitability of the product for the intended application and the completeness of the product data with respect to such application.

This product data sheet is describing the characteristics of this product for which a warranty is granted. Any such warranty is granted exclusively pursuant the terms and conditions of the supply agreement. There will be no guarantee of any kind for the product and its characteristics.

Should you require product information in excess of the data given in this product data sheet or which concerns the specific application of our product, please contact the sales office, which is responsible for you (see [www.infineon.com](http://www.infineon.com), sales&contact). For those that are specifically interested we may provide application notes.

Due to technical requirements our product may contain dangerous substances. For information on the types in question please contact the sales office, which is responsible for you.

Should you intend to use the Product in aviation applications, in health or live endangering or life support applications, please notify. Please note, that for any such applications we urgently recommend

- to perform joint Risk and Quality Assessments;
- the conclusion of Quality Agreements;
- to establish joint measures of an ongoing product survey, and that we may make delivery depended on the realization of any such measures.

If and to the extent necessary, please forward equivalent notices to your customers.

Changes of this product data sheet are reserved.

prepared by: MB	date of publication: 2011-04-19
approved by: MK	revision: 2.0

## Данный компонент на территории Российской Федерации

### Вы можете приобрести в компании MosChip.

Для оперативного оформления запроса Вам необходимо перейти по данной ссылке:

<http://moschip.ru/get-element>

Вы можете разместить у нас заказ для любого Вашего проекта, будь то серийное производство или разработка единичного прибора.

В нашем ассортименте представлены ведущие мировые производители активных и пассивных электронных компонентов.

Нашей специализацией является поставка электронной компонентной базы двойного назначения, продукции таких производителей как XILINX, Intel (ex.ALTERA), Vicor, Microchip, Texas Instruments, Analog Devices, Mini-Circuits, Amphenol, Glenair.

Сотрудничество с глобальными дистрибьюторами электронных компонентов, предоставляет возможность заказывать и получать с международных складов практически любой перечень компонентов в оптимальные для Вас сроки.

На всех этапах разработки и производства наши партнеры могут получить квалифицированную поддержку опытных инженеров.

Система менеджмента качества компании отвечает требованиям в соответствии с ГОСТ Р ИСО 9001, ГОСТ РВ 0015-002 и ЭС РД 009

### Офис по работе с юридическими лицами:

105318, г.Москва, ул.Щербаковская д.3, офис 1107, 1118, ДЦ «Щербаковский»

Телефон: +7 495 668-12-70 (многоканальный)

Факс: +7 495 668-12-70 (доб.304)

E-mail: [info@moschip.ru](mailto:info@moschip.ru)

Skype отдела продаж:

moschip.ru

moschip.ru\_4

moschip.ru\_6

moschip.ru\_9