

# R2, R3, R4

## Industrial Electromagnetic Relays



- Compact size
- Relays of general application
- Cadmium - free contacts
- AC and DC coils
- For plug-in sockets, 35 mm rail mount or on panel mounting \*
- WT (mechanical indicator + lockable front test button) - standard features of relays for plug-in sockets. Relays may be provided with the test buttons (no latching) and plugs (see page 115)
- AUCOTEAM GmbH Berlin - railway standards.

### Contact Data

	R2	R3	R4
<b>Number and type of contacts</b>	<b>DPDT</b>	<b>3PDT</b>	<b>4PDT</b>
Contact material	AgNi**	AgNi**	AgNi**
Rated / max. switching voltage AC	250 V / 440 V	250 V / 440 V	250 V / 250 V
Min. switching voltage	10 V	10 V	10 V
Rated load (capacity)			
AC1	12 A / 250 V AC	10 A / 250 V AC	6 A / 250 V AC
AC15	3 A / 120 V; 1.5 A / 240 V (B300)	3 A / 120 V; 1.5 A / 240 V (B300)	1.5 A / 120 V; 0.75 A / 240 V (C300)
AC3	370 W (single-phase motor)	370 W (single-phase motor)	125 W (single-phase motor)
DC1	12 A / 24 V DC (see Fig. 3.1)	10 A / 24 V DC (see Fig. 3.2)	6 A / 24 V DC (see Fig. 3.3)
DC13	0.22 A / 120 V; 0.1 A / 250 V (R300)	0.22 A / 120 V; 0.1 A / 250 V (R300)	0.22 A / 120 V; 0.1 A / 250 V (R300)
Min. switching current	5 mA	5 mA	5 mA
Max. inrush current	24 A	20 A	12 A
<b>Rated current</b>	<b>12 A</b>	<b>10 A</b>	<b>6 A</b>
Max. breaking capacity AC1	3000 VA	2500 VA	1500 VA
Min. breaking capacity	0.3 W	0.3 W	0.3 W
Contact resistance	≤ 100 mΩ	≤ 100 mΩ	≤ 100 mΩ
Max. operating frequency			
• at rated load	1200 cycles/hour	1200 cycles/hour	1200 cycles/hour
• no load	18000 cycles/hour	18000 cycles/hour	18000 cycles/hour

### Coil Data

Rated voltage	50/60 Hz AC	6 ... 240 V	6 ... 240 V	6 ... 240 V
	DC	5 ... 220 V	5 ... 220 V	5 ... 220 V
Must release voltage		AC: ≥ 0.2 U <sub>n</sub> ; DC: ≥ 0.1 U <sub>n</sub>	AC: ≥ 0.2 U <sub>n</sub> ; DC: ≥ 0.1 U <sub>n</sub>	AC: ≥ 0.2 U <sub>n</sub> ; DC: ≥ 0.1 U <sub>n</sub>
Operating range of supply voltage		see page 54	see page 54	see page 54
Rated power consumption	AC	1.6 VA	1.6 VA	1.6 VA
	DC	0.9 W	0.9 W	0.9 W

### Insulation

Insulation rated voltage		250 V AC	250 V AC	250 V AC
Rated surge voltage		4000 V 1.2 / 50 μs	with AC coils: 2500 V 1.2 / 50 μs with DC coils: 4000 V 1.2 / 50 μs	2500 V 1.2 / 50 μs
Overtoltage category		III	III	II
Insulation pollution degree		3	3	2
Dielectric strength				
• between coil and contacts		2500 V AC type of insulation: basic	2500 V AC type of insulation: basic	2500 V AC type of insulation: basic
• contact clearance		1500 V AC type of clearance: micro-disco.	1500 V AC type of clearance: micro-disco.	1500 V AC type of clearance: micro-disco.
• pole - pole		2500 V AC type of insulation: basic	2500 V AC type of insulation: basic	2500 V AC type of insulation: basic
Contact - coil distance				
• clearance		≥ 2.5 mm	≥ 2.5 mm	≥ 1.6 mm
• creepage		≥ 4 mm	≥ 4 mm	≥ 3.2 mm

### General data

Operating / release time (typical)		AC: 10 ms / 8 ms; DC: 13 ms / 3 ms	AC: 10 ms / 8 ms; DC: 13 ms / 3 ms	AC: 10 ms / 8 ms; DC: 13 ms / 3 ms
Electrical life				
• resistive	AC1	> 10 <sup>5</sup> ; 12 A. 250 V AC see Fig. 2.1	> 10 <sup>5</sup> ; 10 A. 250 V AC see Fig. 2.2	> 10 <sup>5</sup> ; 6 A. 250 V AC see Fig. 2.3
• cosφ				
Mechanical life (cycles)		> 2 x 10 <sup>7</sup>	> 2 x 10 <sup>7</sup>	> 2 x 10 <sup>7</sup>
Dimensions (L x W x H)		27.5 x 21.2 x 35.6 mm	27.5 x 21.2 x 35.6 mm	27.5 x 21.2 x 35.6 mm
Weight		35 g	35 g	35 g
Ambient temperature				
• storage		-40...+85 °C	-40...+85 °C	-40...+85 °C
• operating		AC: -40...+55 °C; DC: -40...+70 °C	AC: -40...+55 °C; DC: -40...+70 °C	AC: -40...+55 °C; DC: -40...+70 °C
Cover protection category		IP 40 PN-EN 60529	IP 40 PN-EN 60529	IP 40 PN-EN 60529
Environmental protection		RTI PN-EN 116000-3	RTI PN-EN 116000-3	RTI PN-EN 116000-3
Shock resistance (NO/NC)		10 g / 5 g	10 g / 5 g	10 g / 5 g
Vibration resistance		5 g 10...150 Hz	5 g 10...150 Hz	5 g 10...150 Hz
Solder bath temperature		max. 270 °C	-	max. 270 °C
Soldering time		max. 5 s	-	max. 5 s

\* PCB or threaded bolt versions contact Altech Corp.

\*\* Other contact materials (eg. gold plated) available, contact Altech Corp.

# R2, R3, R4 Industrial Electromagnetic Relays



## R2 (DPDT)



### CONNECTION DIAGRAM



### DIMENSIONS



### LOAD CHARTS

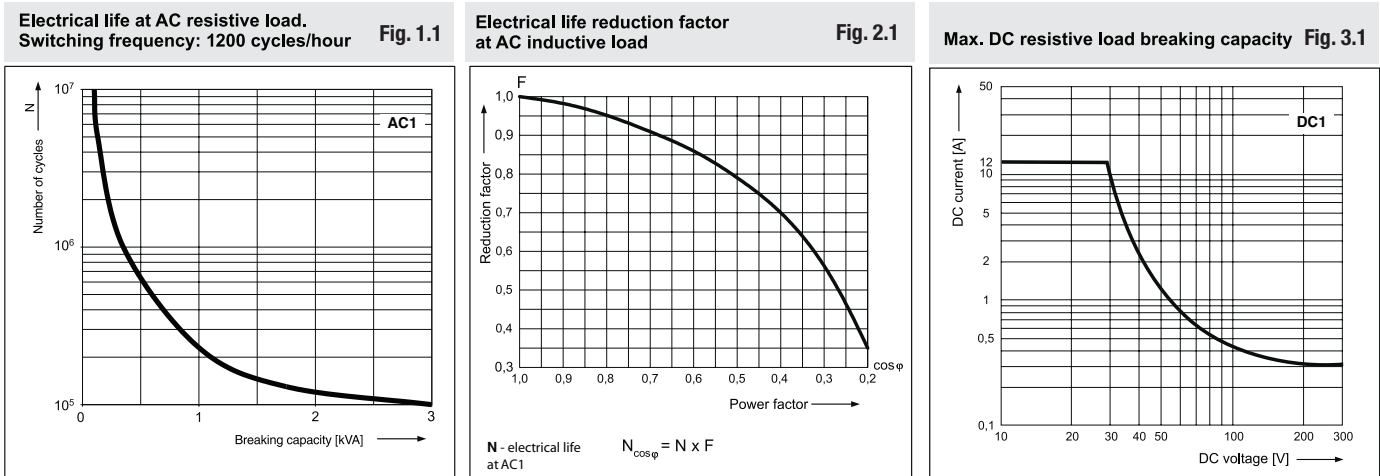

# R2, R3, R4 Industrial Electromagnetic Relays



## R3 (3PDT)



### CONNECTION DIAGRAM

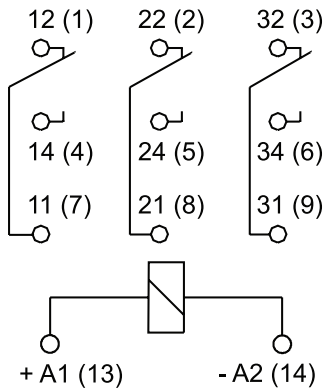

### DIMENSIONS

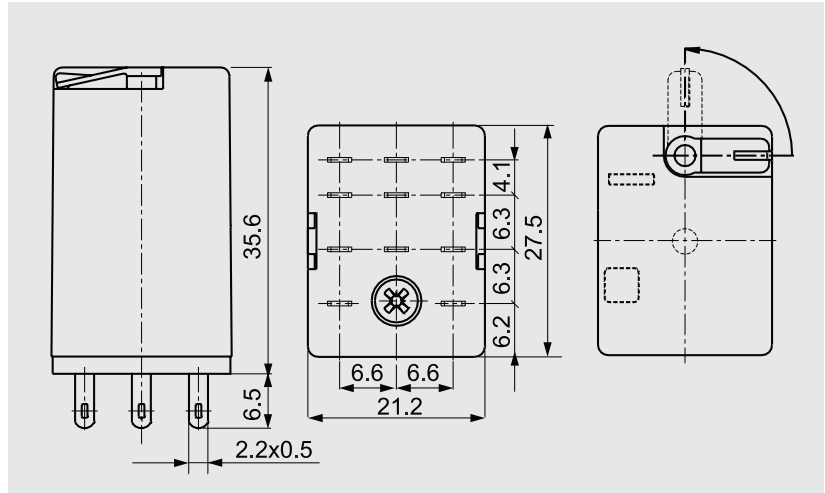

### LOAD CHARTS

Electrical life at AC resistive load.  
Switching frequency: 1200 cycles/hour **Fig. 1.2**

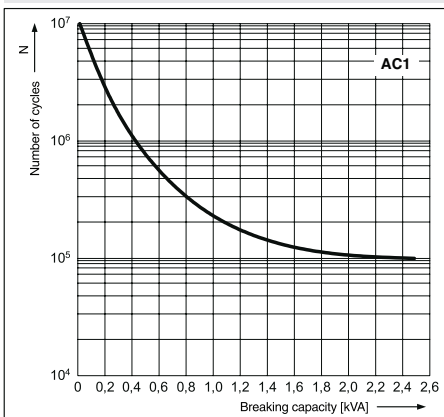

Electrical life reduction factor  
at AC inductive load **Fig. 2.2**

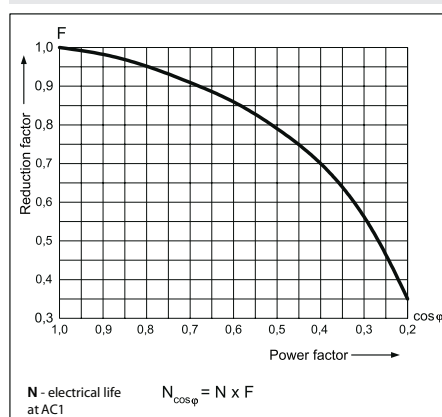

Max. DC breaking capacity  
A - resistive load DC1  
B - inductive load L/R = 40 ms **Fig. 3.2**

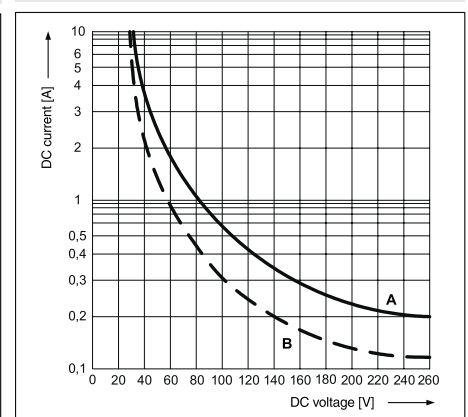

# R2, R3, R4 Industrial Electromagnetic Relays



## R4 (4PDT)



### CONNECTION DIAGRAM



### DIMENSIONS



### LOAD CHARTS

Electrical life at AC resistive load. Switching frequency: 1200 cycles/hour **Fig. 3.1**



Electrical life reduction factor at AC inductive load **Fig. 2.3**



Max. DC breaking capacity **Fig. 3.3**  
A - resistive load DC1  
B - inductive load L/R = 40 ms



# R2, R3, R4

## Industrial Electromagnetic Relays

### R2 DPDT AC 50/60Hz & DC coil

Part Number	Coil Voltage (V)	Coil Type	Coil resistance at 20 °C in Ω	Coil operating range		Options*	
				min. (at 20°C)	max. (at 55°C)	WT	WTL
R2N-2012-23-1012-WT	12	DC	160	9.6	13.2	x	
▶ R2N-2012-23-1012-WTL	12	DC	160	9.6	13.2		x
▶ R2N-2012-23-1024-WT	24	DC	640	19.2	26.4	x	
▶ R2N-2012-23-1024-WTL	24	DC	640	19.2	26.4		x
R2N-2012-23-1110-WT	110	DC	13600	88.0	121.0	x	
R2N-2012-23-1110-WTL	110	DC	13600	88.0	121.0		x
R2N-2012-23-5024-WT	24	AC 50/60Hz	158.0	19.2	26.4	x	
▶ R2N-2012-23-5024-WTL	24	AC 50/60Hz	158.0	19.2	26.4		x
▶ R2N-2012-23-5120-WT	120	AC 50/60Hz	3770	96.0	132.0	x	
▶ R2N-2012-23-5120-WTL	120	AC 50/60Hz	3770	96.0	132.0		x
R2N-2012-23-5230-WT	230	AC 50/60Hz	16100	184.0	253.0	x	
▶ R2N-2012-23-5230-WTL	230	AC 50/60Hz	16100	184.0	253.0		x

### R3 DPDT AC 50/60Hz & DC coil

Part Number	Coil Voltage (V)	Coil Type	Coil resistance at 20 °C in Ω	Coil operating range		Options*	
				min. (at 20°C)	max. (at 55°C)	WT	WTL
R3N-2013-23-1012-WT	12	DC	160	9.6	13.2	x	
▶ R3N-2013-23-1012-WTL	12	DC	160	9.6	13.2		x
R3N-2013-23-1024-WT	24	DC	640	19.2	26.4	x	
▶ R3N-2013-23-1024-WTL	24	DC	640	19.2	26.4		x
R3N-2013-23-1110-WT	110	DC	13600	88.0	121.0	x	
R3N-2013-23-1110-WTL	110	DC	13600	88.0	121.0		x
R3N-2013-23-5024-WT	24	AC 50/60Hz	158.0	19.2	26.4	x	
R3N-2013-23-5024-WTL	24	AC 50/60Hz	158.0	19.2	26.4		x
▶ R3N-2013-23-5120-WT	120	AC 50/60Hz	3770	96.0	132.0	x	
▶ R3N-2013-23-5120-WTL	120	AC 50/60Hz	3770	96.0	132.0		x
R3N-2013-23-5230-WT	230	AC 50/60Hz	16100	184.0	253.0	x	
R3N-2013-23-5230-WTL	230	AC 50/60Hz	16100	184.0	253.0		x

### R4 DPDT AC 50/60Hz & DC coil

Part Number	Coil Voltage (V)	Coil Type	Coil resistance at 20 °C in Ω	Coil operating range		Options*	
				min. (at 20°C)	max. (at 55°C)	WT	WTL
R4N-2014-23-1012-WT	12	DC	160	9.6	13.2	x	
▶ R4N-2014-23-1012-WTL	12	DC	160	9.6	13.2		x
▶ R4N-2014-23-1024-WT	24	DC	640	19.2	26.4	x	
▶ R4N-2014-23-1024-WTL	24	DC	640	19.2	26.4		x
R4N-2014-23-1110-WT	110	DC	13600	88.0	121.0	x	
▶ R4N-2014-23-1110-WTL	110	DC	13600	88.0	121.0		x
R4N-2014-23-5024-WT	24	AC 50/60Hz	158.0	19.2	26.4	x	
▶ R4N-2014-23-5024-WTL	24	AC 50/60Hz	158.0	19.2	26.4		x
▶ R4N-2014-23-5120-WT	120	AC 50/60Hz	3770	96.0	132.0	x	
▶ R4N-2014-23-5120-WTL	120	AC 50/60Hz	3770	96.0	132.0		x
R4N-2014-23-5230-WT	230	AC 50/60Hz	16100	184.0	253.0	x	
▶ R4N-2014-23-5230-WTL	230	AC 50/60Hz	16100	184.0	253.0		x

WT = with mechanical indicator + lockable front test button

WTL = with mechanical indicator + lockable front test button + light indicator (LED)

\* other options available upon request

▶ BOLD - Regular stocked items.

# R2, R3, R4

## Industrial Electromagnetic Relays - Plug-in Sockets and Accessories



### GZT2 (for R2)

Screw terminals  
 Max. tightening moment for the terminal: 0.7 Nm  
 35 mm rail mount  
 acc. to PN-EN 60715  
 or on panel mounting  
 76,3 x 27 x 42.5(80) mm\*  
 Two poles  
 12 A, 300 V AC



ZGGZ4 (see page 111)



Module type M... (see page 113)



GZT2

#### CONNECTION DIAGRAM



#### DIMENSIONS



### GZM2 (for R2)

Screw terminals  
 Max. tightening moment for the terminal: 0.7 Nm  
 35 mm rail mount  
 acc. to PN-EN 60715  
 or on panel mounting  
 75 x 27 x 61(82) mm\*  
 Two poles  
 12 A, 300 V AC



ZGGZ4 (see page 111)



Module type M... (see page 113)



GZM2

#### CONNECTION DIAGRAM



#### DIMENSIONS

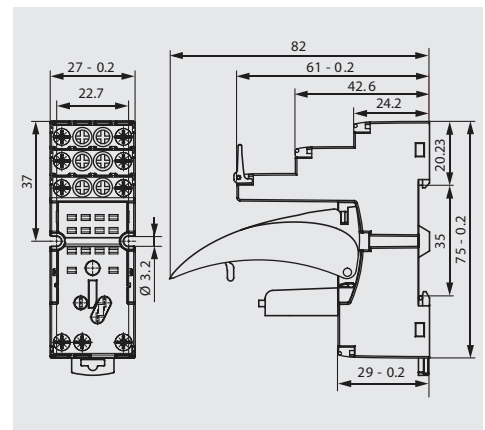

### GZT3 (for R3)

Screw terminals  
 Max. tightening moment for the terminal: 0.7 Nm  
 35 mm rail mount  
 acc. to PN-EN 60715  
 or on panel mounting  
 76,3 x 27 x 42.5(80) mm\*  
 Three poles  
 10 A, 300 V AC



ZGGZ4 (see page 111)



Module type M... (see page 113)



GZT3

#### CONNECTION DIAGRAM



#### DIMENSIONS

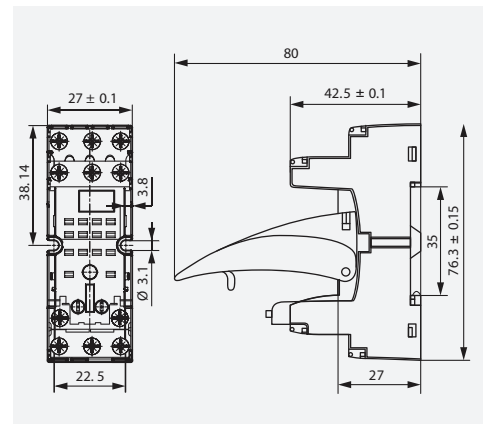

\* In parenthesis is the height of the socket with plastic retainer clip. \*\* For lower profile application.

All accessories are sold separately.

# R2, R3, R4

## Industrial Electromagnetic Relays - Plug-in Sockets and Accessories

### GZM3 (for R3)

Screw terminals  
 Max. tightening moment  
 for the terminal: 0.7 Nm  
 35 mm rail mount  
 acc. to PN-EN 60715  
 or on panel mounting  
 75 x 27 x 61(82) mm\*  
 Three poles  
 10 A, 300 V AC



E22891



GZT2



GZT4-0040



G4 1052\*\*



ZGGZ4 (see page 111)



GZT4-0035



Module type M... (see page 113)

### CONNECTION DIAGRAM

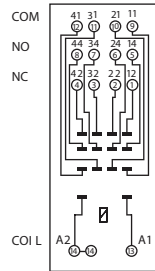

### DIMENSIONS

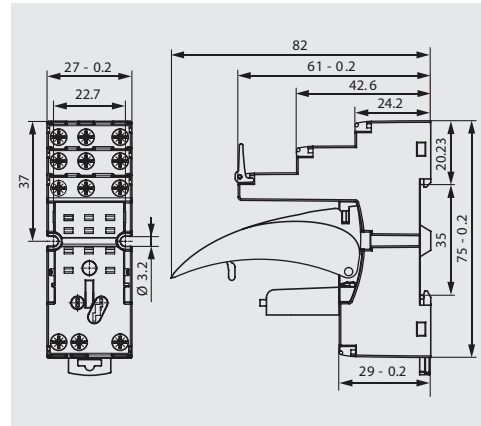

### GZT4 (for R4)

Screw terminals  
 Max. tightening moment  
 for the terminal: 0.7 Nm  
 35 mm rail mount  
 acc. to PN-EN 60715  
 or on panel mounting  
 76,3 x 27 x 42.5(80) mm \*  
 Four poles  
 6 A, 300 V AC



E22891



GZM2



GZT4-0040



G4 1052\*\*



ZGGZ4 (see page 111)



GZT4-0035



Module type M... (see page 113)

### CONNECTION DIAGRAM

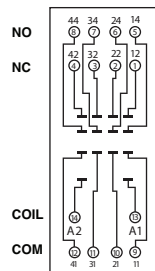

### DIMENSIONS

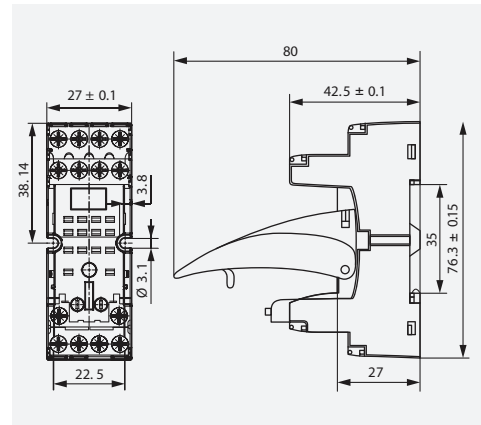

### GZM4 (for R4)

Screw terminals  
 Max. tightening moment  
 for the terminal: 0.7 Nm  
 35 mm rail mount  
 acc. to PN-EN 60715  
 or on panel mounting  
 75 x 27 x 61(82) mm\*  
 Four poles  
 6 A, 300 V AC



E22891



GZT3



GZT4-0040



G4 1052\*\*



ZGGZ4 (see page 111)



GZT4-0035



Module type M... (see page 113)

### CONNECTION DIAGRAM

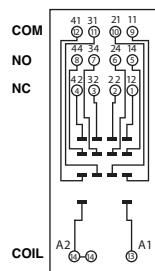

### DIMENSIONS

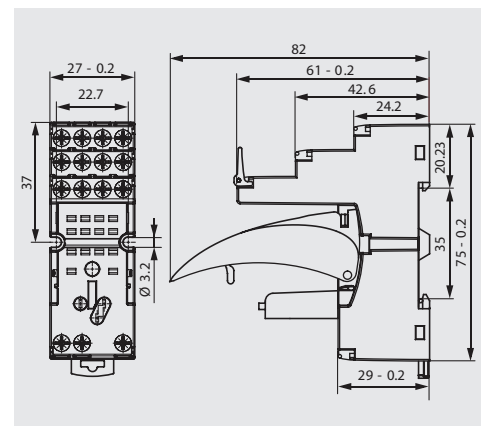

\* In parenthesis is the height of the socket with plastic retainer clip. \*\* For lower profile application.

All accessories are sold separately.

# R2, R3, R4

## Industrial Electromagnetic Relays - Plug-in Sockets and Accessories **Altech**<sup>®</sup>

### GZMB2 (for R2)

Spring terminals

Max. cross section of the cables:

1 x 0,2...1,5 mm<sup>2</sup>

(1 x 24...16 AWG)

Stripping length deinsulation: 9...11 mm

35 mm rail mount

acc. to PN-EN 60715

95 x 31 x 42.5(80) mm\*

Two poles

10 A, 300 V AC



E22891



GZMB2

### CONNECTION DIAGRAM



### DIMENSIONS



GZMB4-0040



G4 1052\*\*



TR



Module type M... (see page 113)

### GZMB4 (for R4)

Spring terminals

Max. cross section of the cables:

1 x 0,2...1,5 mm<sup>2</sup>

(1 x 24...16 AWG)

Stripping length deinsulation:

9...11 mm

35 mm rail mount

acc. to PN-EN 60715

95 x 31 x 42.5(80) mm\*

Four poles

10 A, 300 V AC



E22891



GZMB4

### CONNECTION DIAGRAM



### DIMENSIONS



GZMB4-0040



G4 1052\*\*



TR



Module type M... (see page 113)

\* In parenthesis is the height of the socket with plastic retainer clip. \*\* For lower profile application.

All accessories are sold separately.



## Данный компонент на территории Российской Федерации

### Вы можете приобрести в компании MosChip.

Для оперативного оформления запроса Вам необходимо перейти по данной ссылке:

<http://moschip.ru/get-element>

Вы можете разместить у нас заказ для любого Вашего проекта, будь то серийное производство или разработка единичного прибора.

В нашем ассортименте представлены ведущие мировые производители активных и пассивных электронных компонентов.

Нашей специализацией является поставка электронной компонентной базы двойного назначения, продукции таких производителей как XILINX, Intel (ex.ALTERA), Vicor, Microchip, Texas Instruments, Analog Devices, Mini-Circuits, Amphenol, Glenair.

Сотрудничество с глобальными дистрибьюторами электронных компонентов, предоставляет возможность заказывать и получать с международных складов практически любой перечень компонентов в оптимальные для Вас сроки.

На всех этапах разработки и производства наши партнеры могут получить квалифицированную поддержку опытных инженеров.

Система менеджмента качества компании отвечает требованиям в соответствии с ГОСТ Р ИСО 9001, ГОСТ РВ 0015-002 и ЭС РД 009

### Офис по работе с юридическими лицами:

105318, г.Москва, ул.Щербаковская д.3, офис 1107, 1118, ДЦ «Щербаковский»

Телефон: +7 495 668-12-70 (многоканальный)

Факс: +7 495 668-12-70 (доб.304)

E-mail: [info@moschip.ru](mailto:info@moschip.ru)

Skype отдела продаж:

moschip.ru

moschip.ru\_4

moschip.ru\_6

moschip.ru\_9