

SDP Biased Series - 5x6 QFN

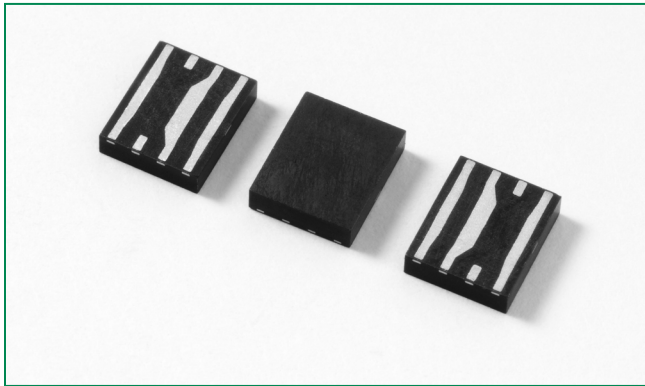

Agency Approvals

| Agency | Agency File Number |
|--------|--------------------|
| | E133083 |

Pinout Designation

| | | | |
|---------|---|---|----------|
| Tip in | 1 | 8 | Tip out |
| - Bias | 2 | 7 | + Bias |
| Ground | 3 | 6 | Ground |
| Ring in | 4 | 5 | Ring out |

Schematic Symbol

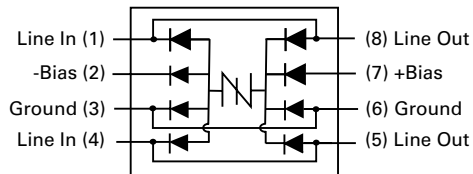

Description

This new SDP Biased series provides overvoltage protection for applications such as VDSL2, ADSL2, and ADSL2+ with minimal effect on data signals. This latest silicon design innovation results in a capacitive loading characteristic that is compatible with these high bandwidth applications. This surface mount QFN package provides a surge capability that exceeds most worldwide standards and recommendations for lightning surge withstand capability of secondary protectors.

Features & Benefits

- Compatible with VDSL2 (30MHz)
- Balanced overvoltage protection
- Low distortion
- Low insertion loss
- Low profile
- SO-8 footprint compatible
- Fails short circuit when surged in excess of ratings
- 2nd level interconnect is Pb-free per IPC/JEDEC J-STD-609A.01

Applicable Global Standards

- TIA-968-A
- TIA-968-B
- ITU K.20/21 Enhanced Level
- ITU K.20/21 Basic Level
- IEC 61000-4-5
- GR 1089 Inter-building
- GR 1089 Intra-building
- YD/T 1082
- YD/T 993
- YD/T 950

Electrical Characteristics

| Part Number | Marking | $V_{DRM} @ I_{DRM}=5\mu A$ | $V_S @ 100V/\mu s$ | I_H | I_S | I_T | $V_T @ I_T=2.2$ Amps | Capacitance |
|--------------|---------|----------------------------|--------------------|--------|--------|-------|-------------------------|----------------------------------|
| | | V min | V max | mA min | mA max | A max | V max | |
| SDP0080Q38CB | SDP-8C | 6 | 25 | 50 | 800 | 2.2 | 8 | See Capacitance vs Voltage Chart |
| SDP0220Q38CB | SDP02C | 16 | 30 | 50 | 800 | 2.2 | 8 | |
| SDP0640Q38CB | SDP06C | 58 | 77 | 150 | 800 | 2.2 | 8 | |
| SDP0720Q38CB | SDP07C | 65 | 88 | 150 | 800 | 2.2 | 8 | |
| SDP0900Q38CB | SDP09C | 75 | 98 | 150 | 800 | 2.2 | 8 | |
| SDP1100Q38CB | SDP11C | 90 | 130 | 150 | 800 | 2.2 | 8 | |
| SDP1300Q38CB | SDP13C | 120 | 160 | 150 | 800 | 2.2 | 8 | |
| SDP1800Q38CB | SDP18C | 170 | 220 | 150 | 800 | 2.2 | 8 | |
| SDP2600Q38CB | SDP26C | 220 | 300 | 150 | 800 | 2.2 | 8 | |
| SDP3100Q38CB | SDP31C | 275 | 350 | 150 | 800 | 2.2 | 8 | |
| SDP3500Q38CB | SDP35C | 320 | 400 | 150 | 800 | 2.2 | 8 | |

Notes:

- Absolute maximum ratings measured at $T_A = 25^\circ C$ (unless otherwise noted).
- Devices are bi-directional (unless otherwise noted).
- Part with * is under development.

V-I: Characteristics



Capacitance vs. Voltage*



* Bias voltage must be lower than V_{DRM}

50/60Hz Ratings

| Parameter Name | Test Conditions | Value | Units |
|--|-----------------|-------|----------|
| I_{TSM} Maximum non-repetitive on-state current, 50/60Hz | 0.5s | 6.5 | A |
| | 1s | 4.6 | |
| | 2s | 3.4 | |
| | 5s | 2.3 | |
| | 30s | 1.3 | |
| | 900s | 0.73 | |

Surge Ratings

| Series | I_{PP} | | | | I_{TSM} |
|--------|--------------|-----------------------------|----------------------|-----------------|-----------------------------|
| | 2x10 μ s | 1.2x50 μ s/8x20 μ s | 10x700/5x310 μ s | 10x1000 μ s | 600V _{RMS} 1 cycle |
| | A min | A min | A min | A min | A _{RMS} |
| C | 500 | 400 | 200 | 100 | 30 |

Notes:
 - Peak pulse current rating (I_{pp}) is repetitive and guaranteed for the life of the product.
 - I_{pp} ratings applicable over temperature range of -40°C to +85°C
 - The device must initially be in thermal equilibrium with -40°C \leq T_j \leq +150°C

Thermal Considerations

| Package | Symbol | Parameter | Value | Unit |
|--|-----------------|---|-------------|------|
|  5x6 QFN | T_j | Junction Temperature | -40 to +150 | °C |
| | T_{STG} | Storage Temperature Range | -40 to +150 | °C |
| | $R_{\theta JA}$ | Thermal Resistance: Junction to Ambient | 100 | °C/W |

Normalized V_S Change vs. Junction Temperature

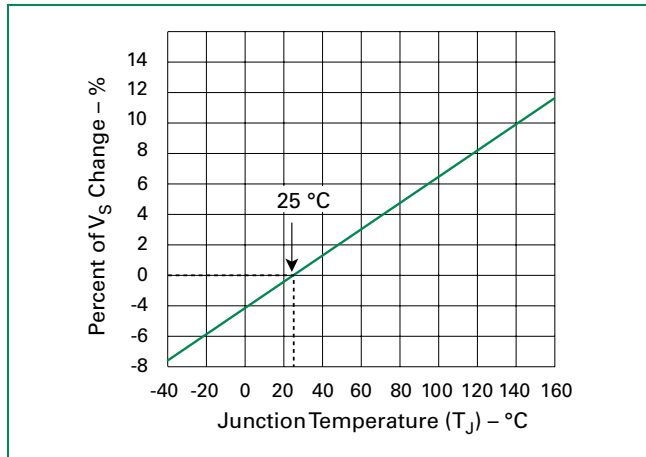

Normalized DC Holding Current vs. Case Temperature

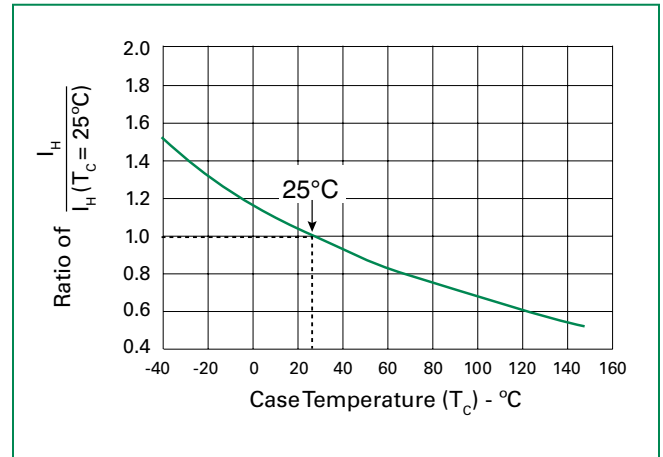

Soldering Parameters

| | | |
|--|-----------------------------------|-------------------------------|
| Reflow Condition | | Pb-Free assembly (see Fig. 1) |
| Pre Heat | -Temperature Min ($T_{s(min)}$) | +150°C |
| | -Temperature Max ($T_{s(max)}$) | +200°C |
| | -Time (Min to Max) (t_s) | 60-180 secs. |
| Average ramp up rate (Liquidus Temp (T_L) to peak) | | 3°C/sec. Max. |
| $T_{s(max)}$ to T_L - Ramp-up Rate | | 3°C/sec. Max. |
| Reflow | -Temperature (T_L) (Liquidus) | +217°C |
| | -Temperature (t_L) | 60-150 secs. |
| Peak Temp (T_p) | | +260(+0/-5)°C |
| Time within 5°C of actual Peak Temp (t_p) | | 30 secs. Max. |
| Ramp-down Rate | | 6°C/sec. Max. |
| Time 25°C to Peak Temp (T_p) | | 8 min. Max. |
| Do not exceed | | +260°C |

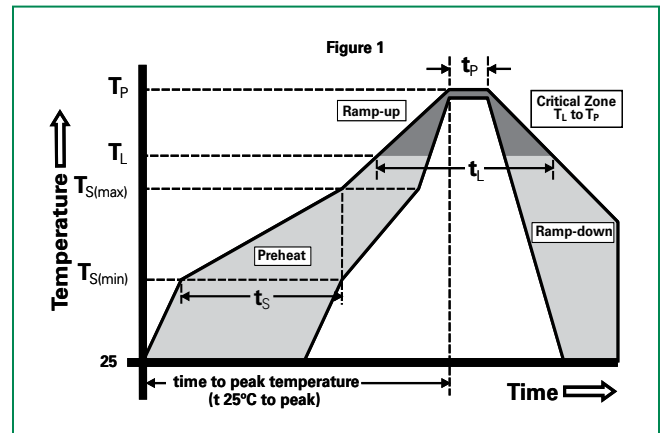

Physical Specifications

| | |
|------------------------|---|
| Lead Material | Copper Alloy |
| Terminal Finish | 100% Matte-Tin Plated |
| Body Material | UL recognized epoxy meeting flammability classification 94V-0 |

Additional Information



Datasheet



Resources



Samples

Environmental Specifications

| | |
|-----------------------------------|--|
| High Temp Voltage Blocking | 80% Rated V_{DRM} ($V_{AC Peak}$) +125°C or +150°C, 504 or 1008 hrs. MIL-STD-750 (Method 1040) JEDEC, JESD22-A-101 |
| Temp Cycling | -65°C to +150°C, 15 min. dwell, 10 up to 100 cycles. MIL-STD-750 (Method 1051) EIA/JEDEC, JESD22-A104 |
| Biased Temp & Humidity | 52 V_{DC} (+85°C) 85%RH, 504 up to 1008 hrs. EIA/JEDEC, JESD22-A-101 |
| High Temp Storage | +150°C 1008 hrs. MIL-STD-750 (Method 1031) JEDEC, JESD22-A-101 |
| Low Temp Storage | -65°C, 1008 hrs. |
| Thermal Shock | 0°C to +100°C, 5 min. dwell, 10 sec. transfer, 10 cycles. MIL-STD-750 (Method 1056) JEDEC, JESD22-A-106 |
| Resistance to Solder Heat | +260°C, 30 secs. MIL-STD-750 (Method 2031) |
| Moisture Sensitivity Level | 85%RH, +85°C, 168 hrs., 3 reflow cycles (+260°C Peak). JEDEC-J-STD-020, Level 1 |

Dimensions — 5x6 QFN

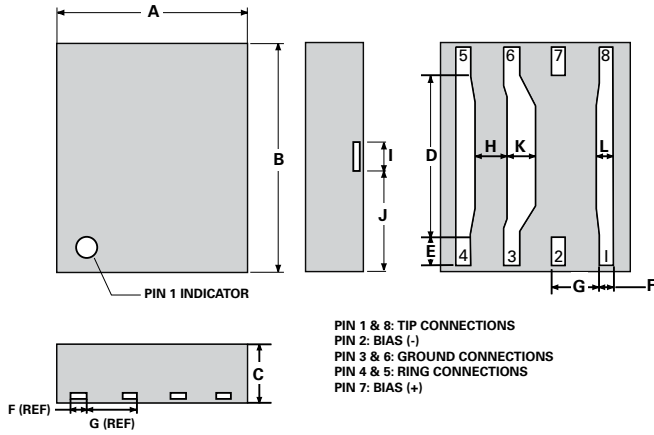

| Dimension | Inches | | Millimeters | |
|-----------|--------|-------|-------------|-------|
| | Min | Max | Min | Max |
| A | 0.187 | 0.207 | 4.745 | 5.253 |
| B | 0.226 | 0.246 | 5.745 | 6.253 |
| C | 0.054 | 0.064 | 1.374 | 1.628 |
| D | 0.165 | 0.171 | 4.199 | 4.351 |
| E | 0.027 | 0.033 | 0.686 | 0.838 |
| F | 0.011 | 0.017 | 0.279 | 0.432 |
| G | 0.047 | 0.053 | 1.194 | 1.346 |
| H | 0.032 | 0.038 | 0.800 | 0.953 |
| I | 0.027 | 0.033 | 0.686 | 0.838 |
| J | 0.100 | 0.106 | 2.540 | 2.692 |
| K | 0.027 | 0.033 | 0.686 | 0.838 |
| L | 0.015 | 0.021 | 0.381 | 0.533 |

5x6 QFN Solder Pad Layout

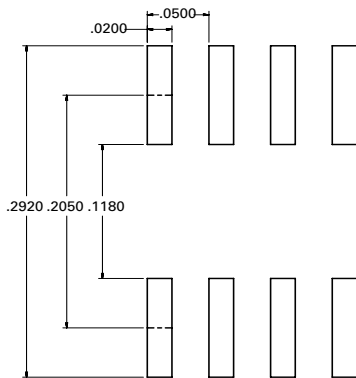

Part Numbering

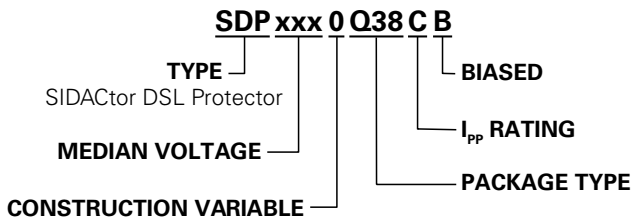

Part Marking

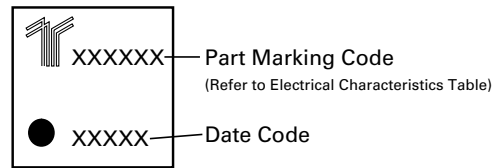

Packing Options

| Package Type | Description | Quantity | Added Suffix | Industry Standard |
|--------------|-----------------------------------|----------|--------------|-------------------|
| Q38 | 5x6x1.5 QFN Tape and Reel Pack | 4000 | N/A | EIA-481-D |

Tape and Reel Specifications — 5x6 QFN

Reel Dimension

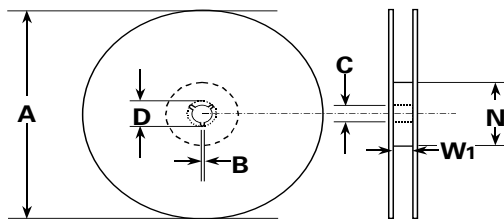

Tape Leader and Trailer Dimensions

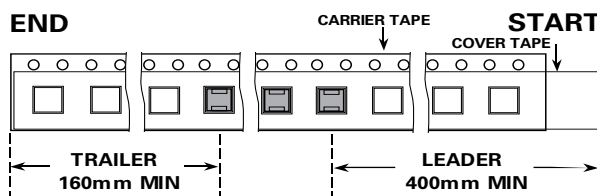

Tape Dimension Items

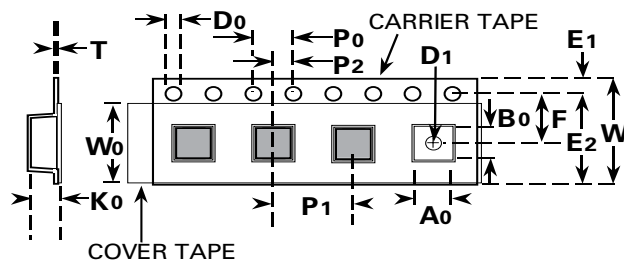

| Symbols | Description | Inches | | Millimeters | |
|----------------------|--|--------|--------|-------------|-------|
| | | Min | Max | Min | Max |
| A | Reel Diameter | N/A | 12.992 | N/A | 330.0 |
| B | Drive Spoke Width | 0.059 | N/A | 1.50 | N/A |
| C | Arbor Hole Diameter | 0.504 | 0.531 | 12.80 | 13.50 |
| D | Drive Spoke Diameter | 0.795 | N/A | 20.20 | N/A |
| N | Hub Diameter | 1.969 | N/A | 50.00 | N/A |
| W₁ | Reel Inner Width at Hub | 0.488 | 0.567 | 12.40 | 14.40 |
| A₀ | Pocket Width at Bottom | 0.204 | 0.212 | 5.20 | 5.40 |
| B₀ | Pocket Length at Bottom | 0.244 | 0.252 | 6.20 | 6.40 |
| D₀ | Feed Hole Diameter | 0.059 | 0.063 | 1.50 | 1.60 |
| D₁ | Pocket Hole Diameter | 0.059 | N/A | 1.50 | N/A |
| E₁ | Feed Hole Position 1 | 0.065 | 0.073 | 1.65 | 1.85 |
| E₂ | Feed Hole Position 2 | 0.400 | 0.408 | 10.15 | 10.35 |
| F | Feed Hole Center - Pocket Hole Center 2 | 0.212 | 0.220 | 5.40 | 5.60 |
| K₀ | Pocket Depth | 0.067 | 0.075 | 1.70 | 1.90 |
| P₀ | Feed Hole Pitch | 0.153 | 0.161 | 3.90 | 4.10 |
| P₁ | Component Spacing | 0.311 | 0.319 | 7.90 | 8.10 |
| P₂ | Feed Hole Center - Pocket Hole Center 1 | 0.077 | 0.081 | 1.90 | 2.10 |
| T | Carrier Tape Thickness | 0.010 | 0.014 | 0.25 | 0.35 |
| W | Embossed Carrier Tape Width | 0.460 | 0.484 | 11.70 | 12.30 |
| W₀ | Cover Tape Width | 0.358 | 0.366 | 9.10 | 9.30 |

Данный компонент на территории Российской Федерации

Вы можете приобрести в компании MosChip.

Для оперативного оформления запроса Вам необходимо перейти по данной ссылке:

<http://moschip.ru/get-element>

Вы можете разместить у нас заказ для любого Вашего проекта, будь то серийное производство или разработка единичного прибора.

В нашем ассортименте представлены ведущие мировые производители активных и пассивных электронных компонентов.

Нашей специализацией является поставка электронной компонентной базы двойного назначения, продукции таких производителей как XILINX, Intel (ex.ALTERA), Vicor, Microchip, Texas Instruments, Analog Devices, Mini-Circuits, Amphenol, Glenair.

Сотрудничество с глобальными дистрибьюторами электронных компонентов, предоставляет возможность заказывать и получать с международных складов практически любой перечень компонентов в оптимальные для Вас сроки.

На всех этапах разработки и производства наши партнеры могут получить квалифицированную поддержку опытных инженеров.

Система менеджмента качества компании отвечает требованиям в соответствии с ГОСТ Р ИСО 9001, ГОСТ РВ 0015-002 и ЭС РД 009

Офис по работе с юридическими лицами:

105318, г.Москва, ул.Щербаковская д.3, офис 1107, 1118, ДЦ «Щербаковский»

Телефон: +7 495 668-12-70 (многоканальный)

Факс: +7 495 668-12-70 (доб.304)

E-mail: info@moschip.ru

Skype отдела продаж:

moschip.ru

moschip.ru_4

moschip.ru_6

moschip.ru_9