

# Melexis development kit

## MLX91208

Rev 001 – 06/03/15

### **1 Description**

The development kit provides the needed information and components to develop a current sensor based on MLX91208. The main goal is to show the functionalities and the features of the part in a simple and effective way.

The kit includes:

- 3 samples MLX91208-CAH
- 3 samples MLX91208-CAL
- 1 separate PCB\_EC01
- 1 separate PCB\_EC02
- 1 separate PCB\_EC03
- 3 shields U\_12
- 2 shields R\_12

The kit does not include a bus bar.

Datasheet and Application Note can be found on [www.melexis.com](http://www.melexis.com)

## 2 PCBs layout

The kit includes different PCB layout to cover different current ranges. The EC-01 has a single trace whereas the EC-02 and EC-03 PCBs offer “coil-like” design with multiple windings, which increases the magnetic flux density and therefore the sensor sensitivity.

### PCB EC-01(single trace) for U-shield and C-shield

The top layer (105 um) is a conductor. The bottom layer is an expanded ground layer

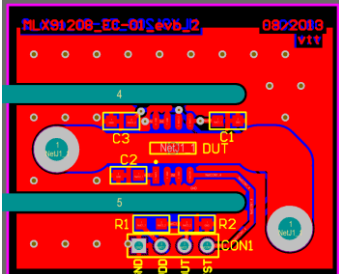
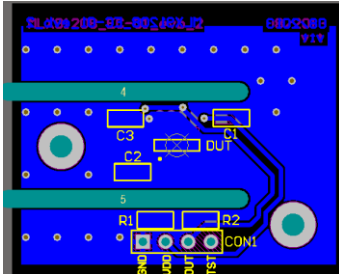
Layer:	<div style="display: flex; justify-content: space-around;"> <div style="text-align: center;"> <p>TOP- layer</p>  </div> <div style="text-align: center;"> <p>Bottom- layer</p>  </div> </div>	
Current:	We recommend <sup>(1)</sup> : MAX 30A RMS for PCB application	
Dimension [l/b/h]:	36.8mm x 30.5mm x 1.6mm	

(1): The maximum current is limited by the PCB. For higher currents (> 30A), one can use an external conductor (i.e. a bus bar).

### PCB EC-02 (three windings)

The top three layers have one conductor trace (3 windings total). The bottom layer is an expanded ground.

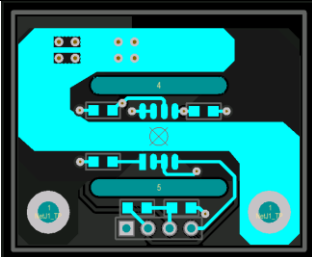
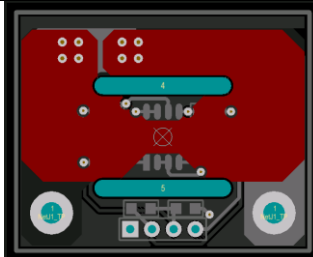
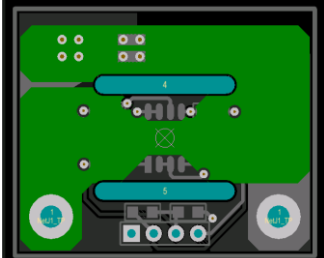
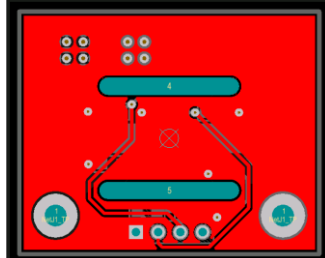
Layer	<div style="display: flex; justify-content: space-around;"> <div style="text-align: center;"> <p>Top- layer</p>  </div> <div style="text-align: center;"> <p>Second- layer</p>  </div> </div>		
	<div style="display: flex; justify-content: space-around;"> <div style="text-align: center;"> <p>Third - layer</p>  </div> <div style="text-align: center;"> <p>Bottom- layer</p>  </div> </div>		
	Current:	We recommend <sup>(1)</sup> : MAX 30A RMS for PCB application	
	Dimension [l/b/h]:	36.8mm x 30.5mm x 2mm	

(1): The maximum current is limited by the PCB. For higher currents (> 30A), one can use an external conductor (i.e. a bus bar).

## PCB EC-03 (6 windings)

The top three layers have two conductor traces (6 windings total). The bottom layer is an expanded ground.

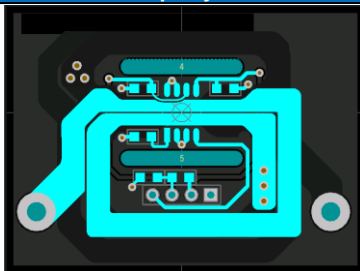
Layer:	Four layers – 6 windings	
	Top- layer	Second- layer
	Third - layer	Bottom- layer
		
Current:	We recommend <sup>(1)</sup> : MAX 7A RMS for PCB application	
Dimension [l/b/h]:	42mm x 35mm x 1.5mm	

(1): The maximum current is limited by the PCB. For higher currents (> 10A), one can use EC-01, EC-02 or an external conductor (i.e. a bus bar).

### 3 Sensor sensitivity

Product Code	Option Code	Sensitivity Range (Typical)
MLX91208	CAL	100-700 mV/mT (250mV/mT)
MLX91208	CAH	50-300 mV/mT (100mV/mT)

The different sensors are factory programmed to the typical sensitivity. Please refer to the datasheet for more details about sensitivity programming.

### 4 Sensor pin-out and connections

**Diagnostic low**

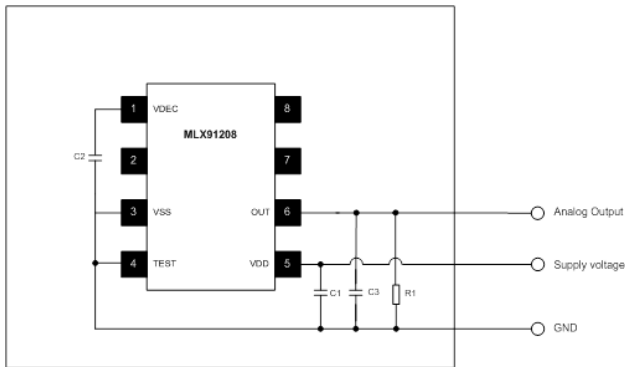

**Diagnostic high**

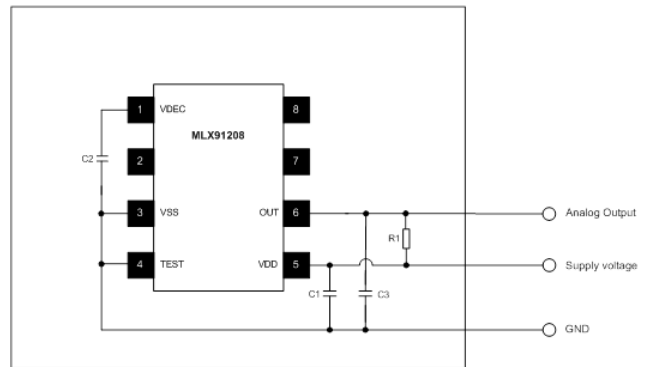

Figure 1: Connections schematic for MLX91208

Table 1: Capacitors/ resistors typical values

Part	Description	Value	Unit
C1	Supply capacitor, EMI, ESD	100	nF
C2	Decoupling, EMI, ESD	47 <sup>(1)</sup>	nF
C3	Decoupling, EMI, ESD	2-10 <sup>(2)</sup>	nF
R1	Pull up or pull down resistor	6-100	kΩ

(1) Optional

(2) 10nF is recommended for better EMC and ESD performance.

Table 2: Sensor PIN designation

Pin #	Name	Type	Function
1	VDEC	Digital	Digital Supply Voltage
3	VSS	Ground	Supply Voltage
4	TEST/MUST	Digital	Test and Factory Calibration
5	VDD	Supply	Supply Voltage
6	OUT	Analog	Current Sensor Output

Table 3: Connectors PIN OUT for PCB EC-03

Pin #	Connected to
1	GND
2	VDD
3	OUT
4	TEST

### 5 U12 and R12 ferromagnetic shields description

The shield is made of soft ferromagnetic material (i.e. low cost Fe-Si or Ni-Fe alloys) with a high permeability ( $\mu_r$ ). The purpose of the shield is both to concentrate the current's magnetic field and to reduce the influence of external stray magnetic fields. Our shield is usable for both bus bar and PCB applications. In order to get a low hysteresis the shields are annealed after shaping. Any applied mechanical stress will deteriorate the performance and should be avoided.

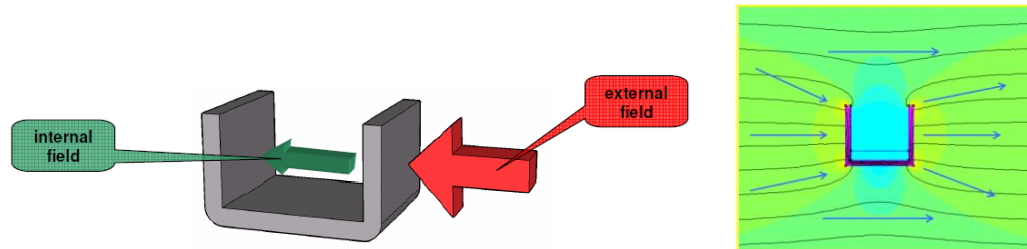

#### Geometry U12

View	Dimension [mm]

- Material: NiFe 48%
- Shielding factor is > 50 in the linear range
- Nonlinearity is < 0.05mT in the linear range
- The onset of the saturation starts at about  $\pm 25$ mT
- Weight: 3.14g

#### Geometry R12 : R-12 x 8 x 6 x 0.8

View	Dimension [mm]

**Recommendation about shield positions**

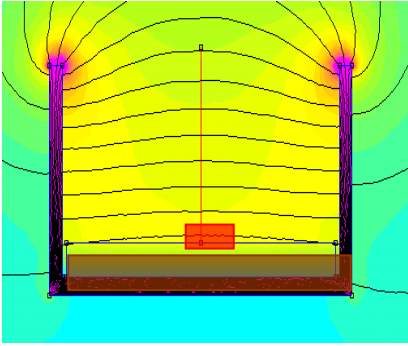
Simulation	Recommendation
	<ul style="list-style-type: none"> <li>• The closer the sensor to the ground plate of the shield, the better the shielding against external stray fields → try to position the sensor as close as possible to the ground plate of the shield</li> <li>• The higher and longer the shield the better the shielding → choose the right dimension for your application</li> <li>• The closer the sensor to the bus bar the better is the signal to noise ratio → try to position the sensor as close as possible to the bus bar</li> </ul>

**Ferromagnetic shield supplier**

Melexis partnered with MagLab and PML India for ferromagnetic material supply.



[www.maglab.ch](http://www.maglab.ch)



[www.pmlindia.com](http://www.pmlindia.com)

Recently, PML and maglab signed an exclusive collaboration in the field of contactless current sensing. This cooperation between maglab and PML offers an efficient and cost-effective solution for customers requiring magnetic shields. maglab takes care of the engineering side, while PML manufactures the products to our specifications.

### 6 Typical output curves for different current ranges

#### 6.1 Typical output with PCB\_EC-01

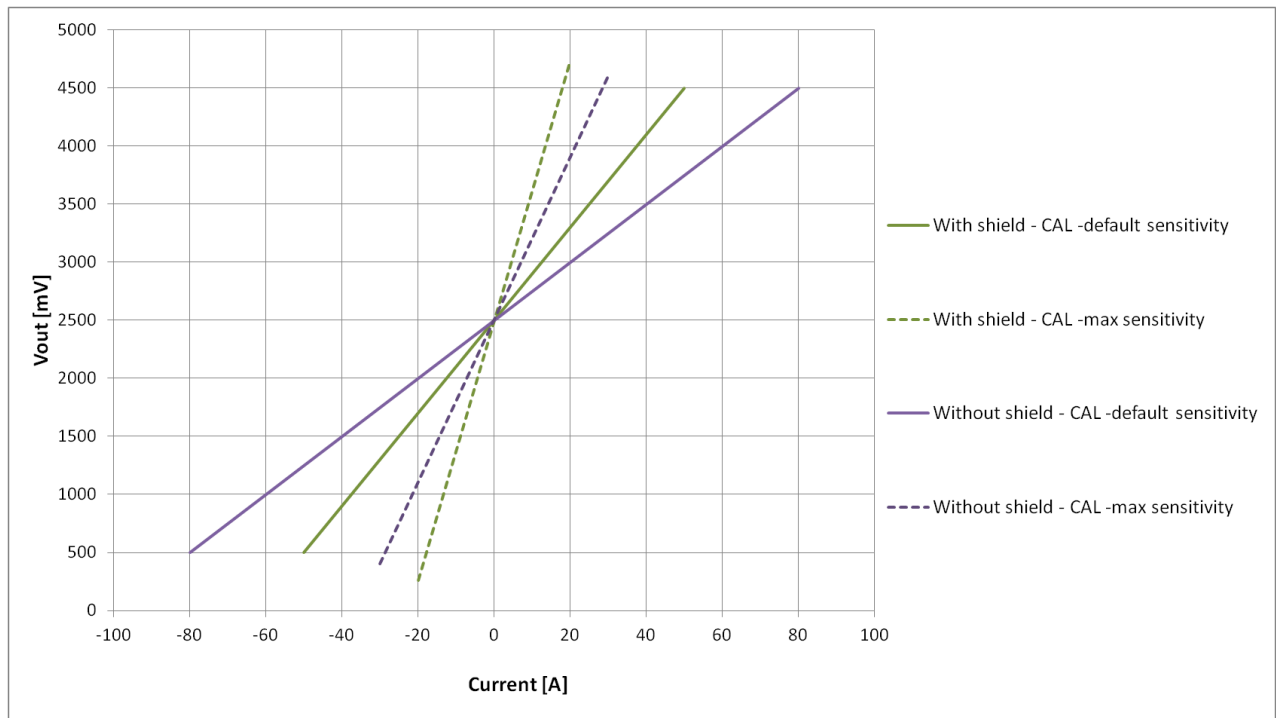

	with shield		without shield	
	91208 – CAL (default sensitivity)	91208 – CAL (calibrated with max sensitivity)	91208 – CAL (default sensitivity)	91208 – CAL (calibrated with max sensitivity)
Sensitivity [mV/A]:	40	100	25	66
Current range [A]:	+/- 50*	+/- 20	+/-80*	+/- 30*

\* The maximum current is limited by the PCB trace. For higher currents (> 30A DC), consider use a bus bar connector.

**6.2 Typical output with PCB\_EC-02**

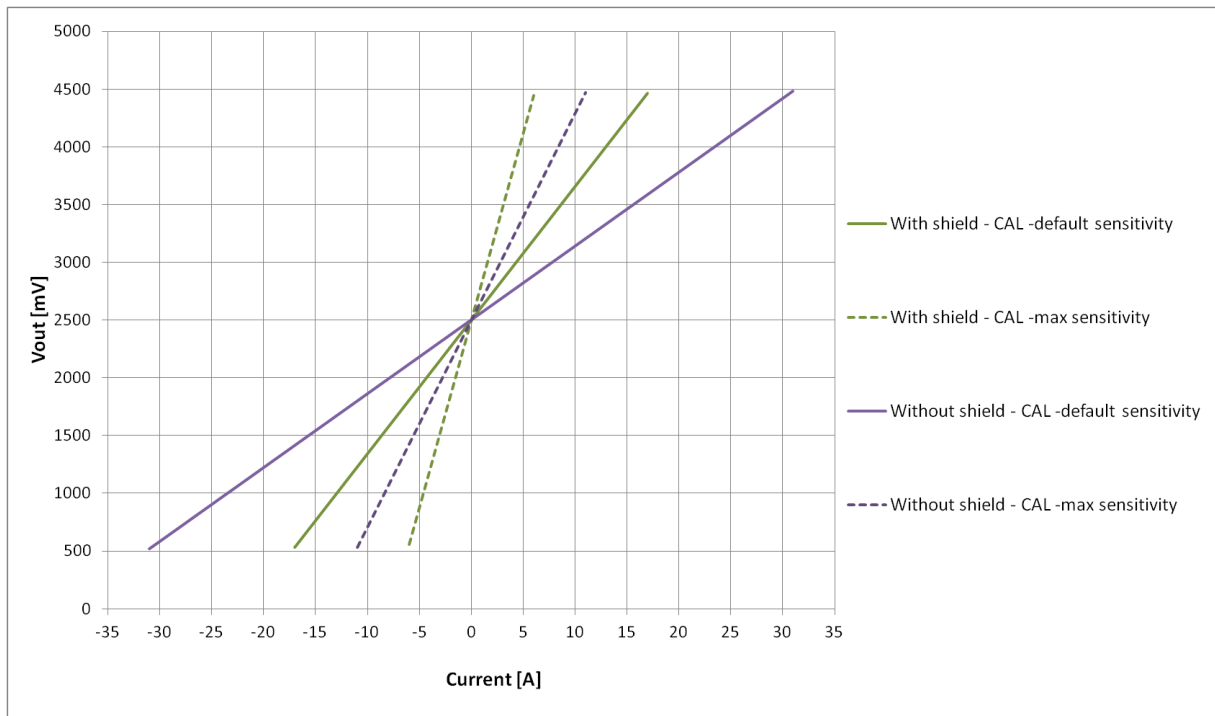
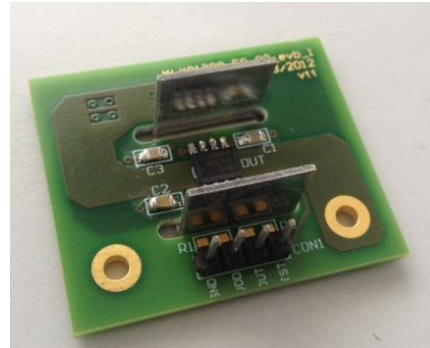

	with shield		without shield	
	91208 – CAL (default sensitivity)	91208 – CAL (calibrated with max sensitivity)	91208 – CAL (default sensitivity)	91208 – CAL (calibrated with max sensitivity)
Sensitivity [mV/A]:	100	333	66	200
Current range [A]:	+/- 20	+/- 6	+/- 30*	+/- 10

\* The maximum current is limited by the PCB trace. For higher currents (> 30A DC), consider use a bus bar connector.



### 6.3 Typical output with PCB\_EC-03

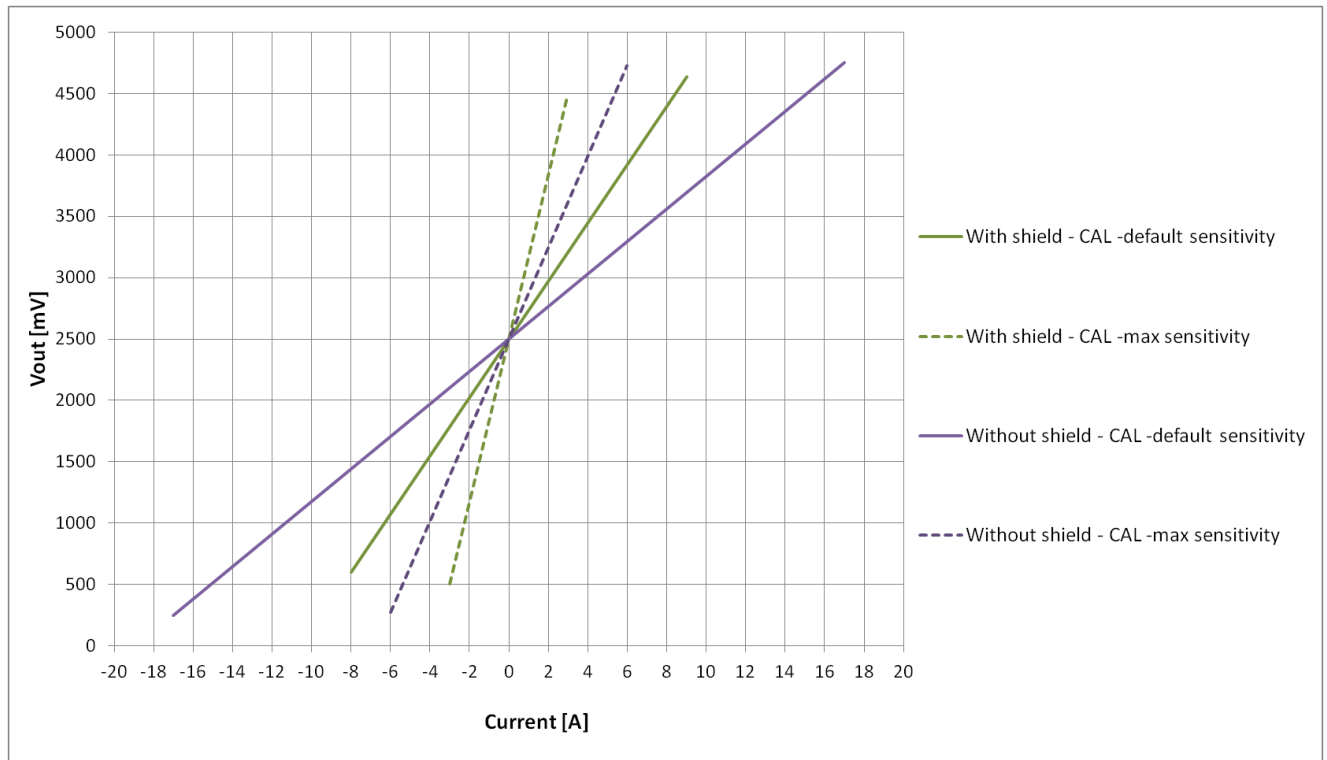
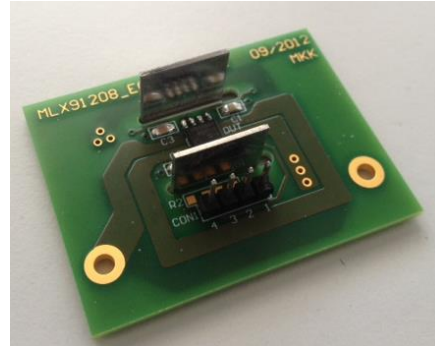
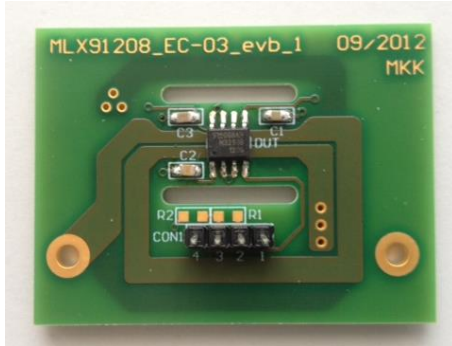

	with shield		without shield	
	91208 – CAL (default sensitivity)	91208 – CAL (calibrated with max sensitivity)	91208 – CAL (default sensitivity)	91208 – CAL (calibrated with max sensitivity)
Sensitivity [mV/A]:	250	666	133	400
Current range [A]:	+/- 8	+/- 3	+/- 15*	+/- 5

\* The maximum current is limited by the PCB trace. For higher currents (> 10A DC), consider use a bus bar connector.

## 6.4 Typical output with C-shield

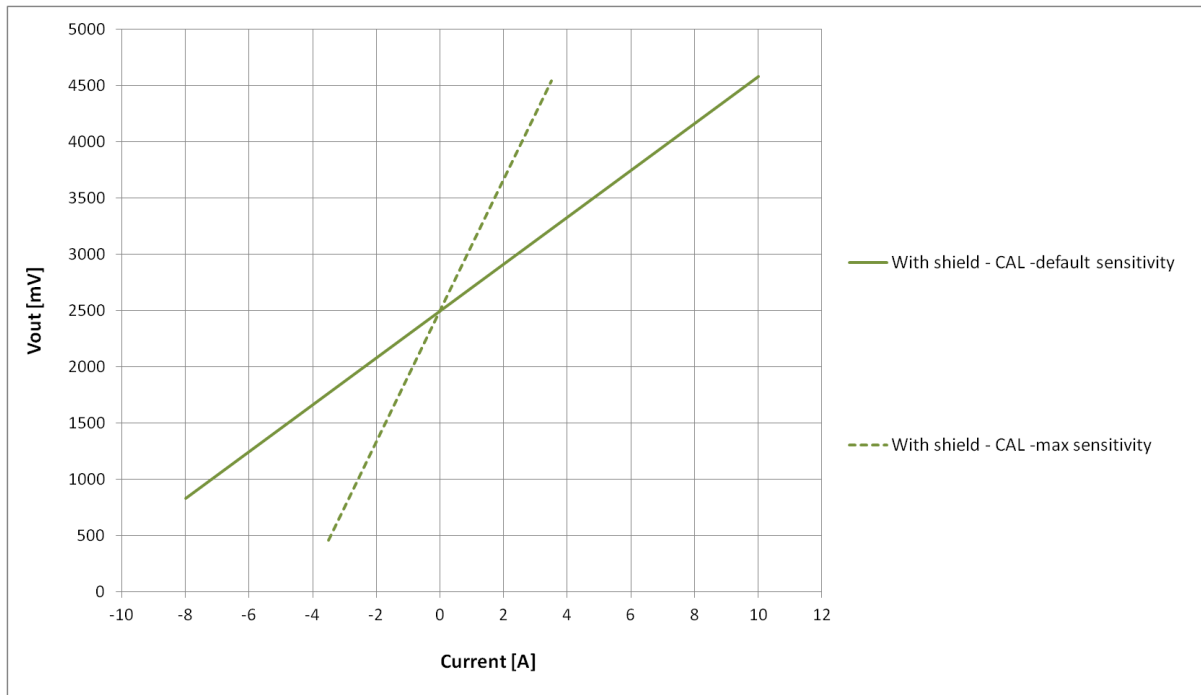
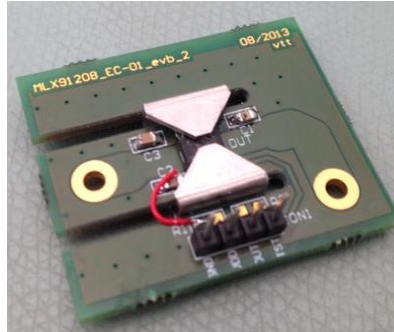

	with C-shield. 1.5 mm airgap	
	91208 – CAL (default sensitivity)	91208 – CAL (calibrated with max sensitivity)
Sensitivity [mV/A]:	200	500
Current range [A]:	+/- 10	+/- 4

**6.5 Typical output with bus bar**

- Demonstrator based on bus bar 12mm x 100mm x 2mm;

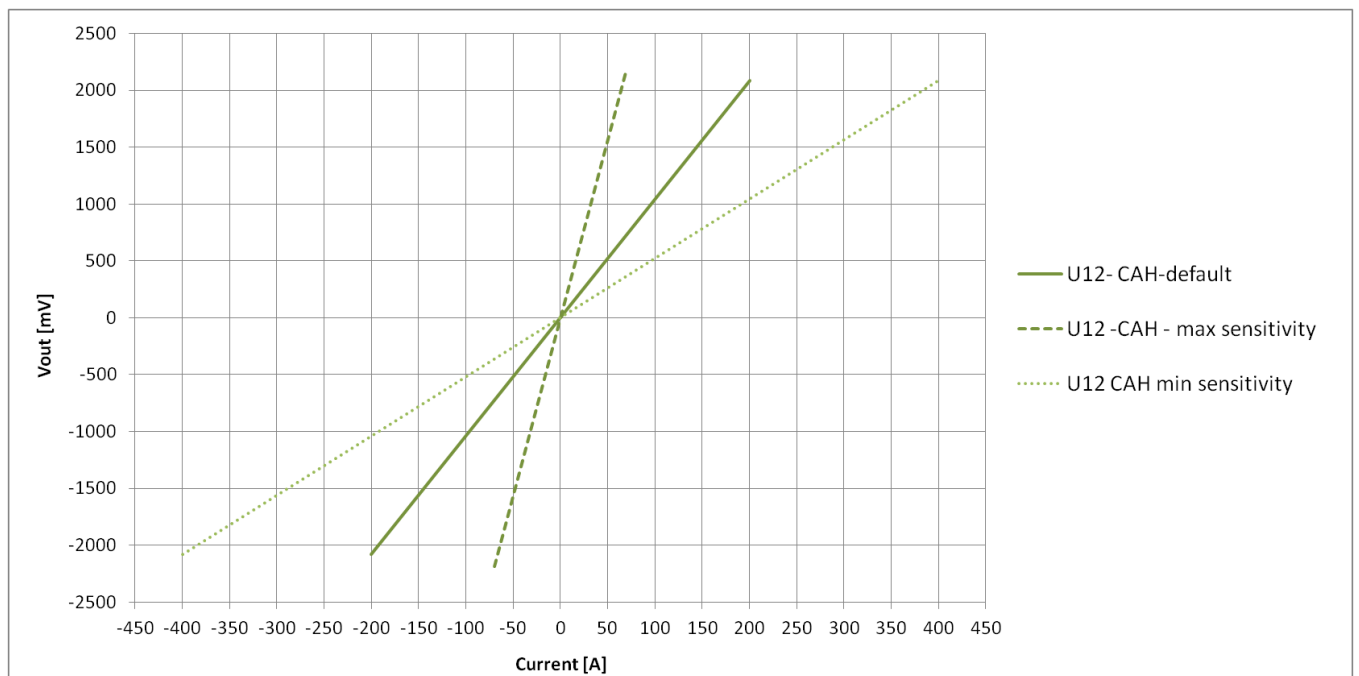
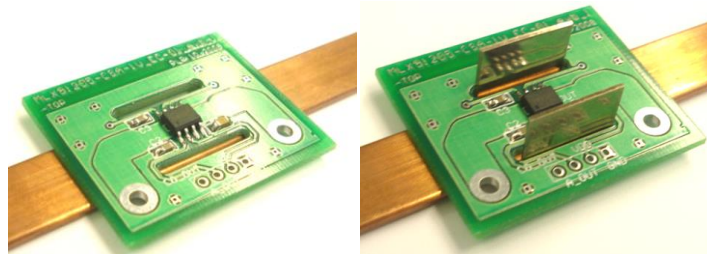

	with shield		
	91208 – CAH (default sensitivity)	91208 – CAH (calibrated with max sensitivity)	91208 – CAH (calibrated with min sensitivity)
Sensitivity [mV/A]:	10 mV/A	31 mV/A	5 mV/A
Current range [A]:	+/- 200	+/- 65	+/- 380

## ***7 Links***

Please consult the following documents for additional information:

- Application note MLX91208;
- Datasheets MLX91208;
- [Current sensors reference design guide](#);

## Данный компонент на территории Российской Федерации

### Вы можете приобрести в компании MosChip.

Для оперативного оформления запроса Вам необходимо перейти по данной ссылке:

<http://moschip.ru/get-element>

Вы можете разместить у нас заказ для любого Вашего проекта, будь то серийное производство или разработка единичного прибора.

В нашем ассортименте представлены ведущие мировые производители активных и пассивных электронных компонентов.

Нашей специализацией является поставка электронной компонентной базы двойного назначения, продукции таких производителей как XILINX, Intel (ex.ALTERA), Vicor, Microchip, Texas Instruments, Analog Devices, Mini-Circuits, Amphenol, Glenair.

Сотрудничество с глобальными дистрибьюторами электронных компонентов, предоставляет возможность заказывать и получать с международных складов практически любой перечень компонентов в оптимальные для Вас сроки.

На всех этапах разработки и производства наши партнеры могут получить квалифицированную поддержку опытных инженеров.

Система менеджмента качества компании отвечает требованиям в соответствии с ГОСТ Р ИСО 9001, ГОСТ РВ 0015-002 и ЭС РД 009

### Офис по работе с юридическими лицами:

105318, г.Москва, ул.Щербаковская д.3, офис 1107, 1118, ДЦ «Щербаковский»

Телефон: +7 495 668-12-70 (многоканальный)

Факс: +7 495 668-12-70 (доб.304)

E-mail: [info@moschip.ru](mailto:info@moschip.ru)

Skype отдела продаж:

moschip.ru

moschip.ru\_4

moschip.ru\_6

moschip.ru\_9