

# FRED Pt<sup>®</sup>

## Ultrafast Soft Recovery Diode Module, 360 A



TO-244

**FEATURES**

- Very low  $Q_{rr}$  and  $t_{rr}$
- UL approved file E222165 
- Designed and qualified for industrial level
- Material categorization:  
For definitions of compliance please see [www.vishay.com/doc?99912](http://www.vishay.com/doc?99912)

**RoHS**  
COMPLIANT

**BENEFITS**

- Reduced RFI and EMI
- Higher frequency operation
- Reduced snubbing

**DESCRIPTION**

FRED Pt<sup>®</sup> diodes are optimized to reduce losses and EMI/RFI in high frequency power conditioning systems. The softness of the recovery eliminates the need for a snubber in most applications. These devices are ideally suited for HF welding, power converters and other applications where switching losses are a significant portion of the total losses.

PRODUCT SUMMARY	
$I_{F(AV)}$	360 A
$V_R$	400 V
$Q_{rr}$ (typical)	1250 nC
$t_{rr}$	40 ns
Type	Modules - Diode, FRED Pt <sup>®</sup>

ABSOLUTE MAXIMUM RATINGS				
PARAMETER	SYMBOL	TEST CONDITIONS	MAX.	UNITS
Cathode to anode voltage	$V_R$		400	V
Continuous forward current per diode	$I_{F(AV)}$	$T_C = 25\text{ °C}$	510	A
		$T_C = 85\text{ °C}$	305	
		$T_C = 116\text{ °C}$	180	
Single pulse forward current per diode	$I_{FSM}$		1200	
Maximum power dissipation	$P_D$	$T_C = 25\text{ °C}$	570	W
		$T_C = 110\text{ °C}$	180	
Operating junction and storage temperatures	$T_J, T_{Stg}$		-40 to 150	°C

ELECTRICAL SPECIFICATIONS PER LEG ( $T_J = 25\text{ °C}$ unless otherwise specified)						
PARAMETER	SYMBOL	TEST CONDITIONS	MIN.	TYP.	MAX.	UNITS
Breakdown voltage	$V_{BR}$	$I_R = 100\text{ }\mu\text{A}$	400	-	-	V
Forward voltage	$V_{FM}$	$I_F = 180\text{ A}$	-	1.09	1.27	
		$I_F = 360\text{ A}$	-	1.23	1.50	
		$I_F = 180\text{ A}, T_J = 150\text{ °C}$	-	0.88	0.96	
		$I_F = 360\text{ A}, T_J = 150\text{ °C}$	-	1.04	1.18	
Reverse leakage current	$I_{RM}$	$T_J = 150\text{ °C}, V_R = V_R$ rated	-	0.26	1.28	mA
Series inductance	$L_S$	From top of terminal hole to mounting plane	-	5	-	nH



<b>DYNAMIC RECOVERY CHARACTERISTICS</b> ( $T_J = 25\text{ }^\circ\text{C}$ unless otherwise specified)						
PARAMETER	SYMBOL	TEST CONDITIONS	MIN.	TYP.	MAX.	UNITS
Reverse recovery time	$t_{rr}$	$I_F = 1.0\text{ A}$ , $di_F/dt = 200\text{ A}/\mu\text{s}$ , $V_R = 30\text{ V}$	-	40	69	ns
		$T_J = 25\text{ }^\circ\text{C}$	-	74	-	
		$T_J = 150\text{ }^\circ\text{C}$	-	171	-	
Peak recovery current	$I_{RRM}$	$I_F = 1.0\text{ A}$ , $di_F/dt = 200\text{ A}/\mu\text{s}$ , $V_R = 30\text{ V}$	-	5.1	-	A
		$I_F = 180\text{ A}$ , $di_F/dt = 200\text{ A}/\mu\text{s}$ , $V_R = 200\text{ V}$	-	6.6	-	
		$I_F = 180\text{ A}$ , $di_F/dt = 200\text{ A}/\mu\text{s}$ , $V_R = 200\text{ V}$ , $T_J = 150\text{ }^\circ\text{C}$	-	15.2	-	
Reverse recovery charge	$Q_{rr}$	$I_F = 1.0\text{ A}$ , $di_F/dt = 200\text{ A}/\mu\text{s}$ , $V_R = 30\text{ V}$	-	125	-	nC
		$I_F = 180\text{ A}$ , $di_F/dt = 200\text{ A}/\mu\text{s}$ , $V_R = 200\text{ V}$	-	243	-	
		$I_F = 180\text{ A}$ , $di_F/dt = 200\text{ A}/\mu\text{s}$ , $V_R = 200\text{ V}$ , $T_J = 150\text{ }^\circ\text{C}$	-	1295	-	

<b>THERMAL - MECHANICAL SPECIFICATIONS</b>						
PARAMETER	SYMBOL	MIN.	TYP.	MAX.	UNITS	
Thermal resistance, junction to case	per leg	-	-	0.19	$^\circ\text{C}/\text{W}$	
	per module	-	-	0.095		
Thermal resistance, case to heatsink (flag greased surface)	$R_{thCS}$	-	0.10	-		
Weight		-	68	-	g	
		-	2.4	-	oz.	
Mounting torque		30 (3.4)	-	40 (4.6)	lbf · in (N · m)	
Mounting torque center hole		12 (1.4)	-	18 (2.1)		
Terminal torque		30 (3.4)	-	40 (4.6)		
Vertical pull		-	-	80	lbf · in	
2" lever pull		-	-	35		
Case style		TO-244 (TO-244AB)				

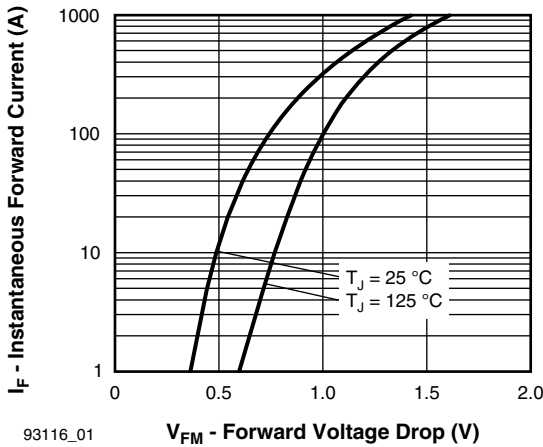

Fig. 1 - Typical Forward Voltage Drop vs. Instantaneous Forward Current (Per Leg)

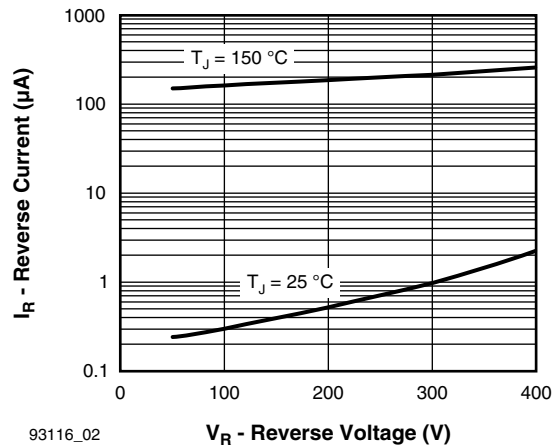
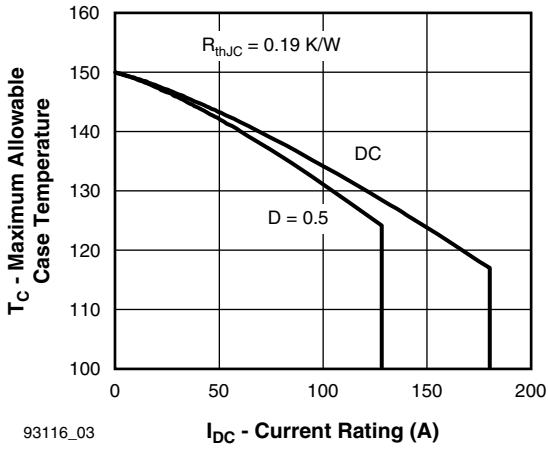
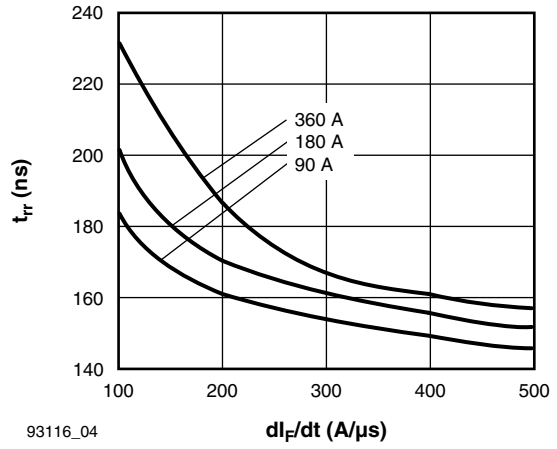

Fig. 2 - Typical Reverse Current vs. Reverse Voltage (Per Leg)



93116\_03

Fig. 3 - Maximum Current Rating Capability (Per Leg)



93116\_04

Fig. 4 - Typical Reverse Recovery Time vs.  $dI_F/dt$   
 $T_J = 125^\circ\text{C}$  (Per Leg)

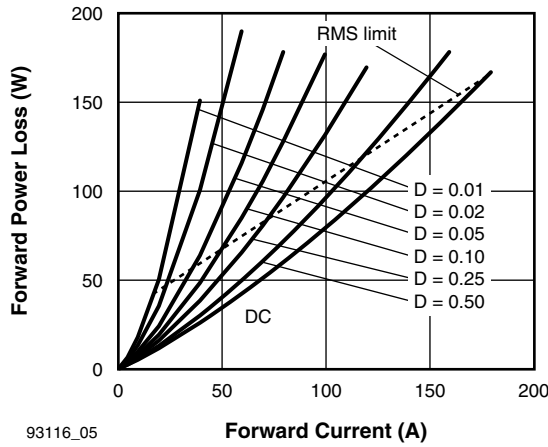

93116\_05

Fig. 5 - Forward Power Loss Characteristics

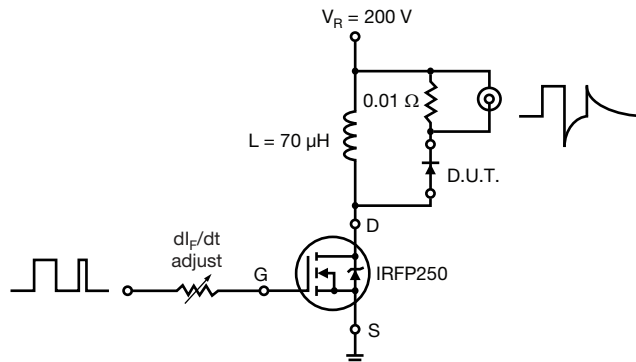
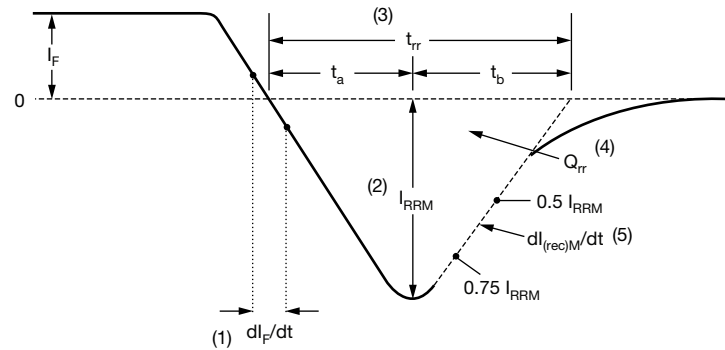

Fig. 6 - Reverse Recovery Parameter Test Circuit



(1)  $di_F/dt$  - rate of change of current through zero crossing

(4)  $Q_{rr}$  - area under curve defined by  $t_{rr}$  and  $I_{RRM}$

(2)  $I_{RRM}$  - peak reverse recovery current

$$Q_{rr} = \frac{t_{rr} \times I_{RRM}}{2}$$

(3)  $t_{rr}$  - reverse recovery time measured from zero crossing point of negative going  $I_F$  to point where a line passing through  $0.75 I_{RRM}$  and  $0.50 I_{RRM}$  extrapolated to zero current.

(5)  $di_{(rec)M}/dt$  - peak rate of change of current during  $t_b$  portion of  $t_{rr}$

Fig. 7 - Reverse Recovery Waveform and Definitions

### ORDERING INFORMATION TABLE

Device code	<b>VS-VS</b>	<b>UD</b>	<b>360</b>	<b>C</b>	<b>W</b>	<b>40</b>
	1	2	3	4	5	6

- 1** - Vishay Semiconductors product
- 2** - Type of device: UD = FRED Pt<sup>®</sup>
- 3** - Current rating (360 = 360 A)
- 4** - Circuit configuration:  
C = Common cathode
- 5** - Type of device:  
W = TO-244 wire bondable not isolated
- 6** - Voltage rating (40 = 400 V)

CIRCUIT CONFIGURATION		
CIRCUIT	CIRCUIT CONFIGURATION CODE	CIRCUIT DRAWING
Two diodes common cathodes	C	

LINKS TO RELATED DOCUMENTS	
Dimensions	<a href="http://www.vishay.com/doc?95021">www.vishay.com/doc?95021</a>



## TO-244

**DIMENSIONS** in millimeters (inches)





## Disclaimer

ALL PRODUCT, PRODUCT SPECIFICATIONS AND DATA ARE SUBJECT TO CHANGE WITHOUT NOTICE TO IMPROVE RELIABILITY, FUNCTION OR DESIGN OR OTHERWISE.

Vishay Intertechnology, Inc., its affiliates, agents, and employees, and all persons acting on its or their behalf (collectively, "Vishay"), disclaim any and all liability for any errors, inaccuracies or incompleteness contained in any datasheet or in any other disclosure relating to any product.

Vishay makes no warranty, representation or guarantee regarding the suitability of the products for any particular purpose or the continuing production of any product. To the maximum extent permitted by applicable law, Vishay disclaims (i) any and all liability arising out of the application or use of any product, (ii) any and all liability, including without limitation special, consequential or incidental damages, and (iii) any and all implied warranties, including warranties of fitness for particular purpose, non-infringement and merchantability.

Statements regarding the suitability of products for certain types of applications are based on Vishay's knowledge of typical requirements that are often placed on Vishay products in generic applications. Such statements are not binding statements about the suitability of products for a particular application. It is the customer's responsibility to validate that a particular product with the properties described in the product specification is suitable for use in a particular application. Parameters provided in datasheets and/or specifications may vary in different applications and performance may vary over time. All operating parameters, including typical parameters, must be validated for each customer application by the customer's technical experts. Product specifications do not expand or otherwise modify Vishay's terms and conditions of purchase, including but not limited to the warranty expressed therein.

Except as expressly indicated in writing, Vishay products are not designed for use in medical, life-saving, or life-sustaining applications or for any other application in which the failure of the Vishay product could result in personal injury or death. Customers using or selling Vishay products not expressly indicated for use in such applications do so at their own risk. Please contact authorized Vishay personnel to obtain written terms and conditions regarding products designed for such applications.

No license, express or implied, by estoppel or otherwise, to any intellectual property rights is granted by this document or by any conduct of Vishay. Product names and markings noted herein may be trademarks of their respective owners.

## Material Category Policy

**Vishay Intertechnology, Inc. hereby certifies that all its products that are identified as RoHS-Compliant fulfill the definitions and restrictions defined under Directive 2011/65/EU of The European Parliament and of the Council of June 8, 2011 on the restriction of the use of certain hazardous substances in electrical and electronic equipment (EEE) - recast, unless otherwise specified as non-compliant.**

**Please note that some Vishay documentation may still make reference to RoHS Directive 2002/95/EC. We confirm that all the products identified as being compliant to Directive 2002/95/EC conform to Directive 2011/65/EU.**

**Vishay Intertechnology, Inc. hereby certifies that all its products that are identified as Halogen-Free follow Halogen-Free requirements as per JEDEC JS709A standards. Please note that some Vishay documentation may still make reference to the IEC 61249-2-21 definition. We confirm that all the products identified as being compliant to IEC 61249-2-21 conform to JEDEC JS709A standards.**

## Данный компонент на территории Российской Федерации

### Вы можете приобрести в компании MosChip.

Для оперативного оформления запроса Вам необходимо перейти по данной ссылке:

<http://moschip.ru/get-element>

Вы можете разместить у нас заказ для любого Вашего проекта, будь то серийное производство или разработка единичного прибора.

В нашем ассортименте представлены ведущие мировые производители активных и пассивных электронных компонентов.

Нашей специализацией является поставка электронной компонентной базы двойного назначения, продукции таких производителей как XILINX, Intel (ex.ALTERA), Vicor, Microchip, Texas Instruments, Analog Devices, Mini-Circuits, Amphenol, Glenair.

Сотрудничество с глобальными дистрибьюторами электронных компонентов, предоставляет возможность заказывать и получать с международных складов практически любой перечень компонентов в оптимальные для Вас сроки.

На всех этапах разработки и производства наши партнеры могут получить квалифицированную поддержку опытных инженеров.

Система менеджмента качества компании отвечает требованиям в соответствии с ГОСТ Р ИСО 9001, ГОСТ РВ 0015-002 и ЭС РД 009

### Офис по работе с юридическими лицами:

105318, г.Москва, ул.Щербаковская д.3, офис 1107, 1118, ДЦ «Щербаковский»

Телефон: +7 495 668-12-70 (многоканальный)

Факс: +7 495 668-12-70 (доб.304)

E-mail: [info@moschip.ru](mailto:info@moschip.ru)

Skype отдела продаж:

moschip.ru

moschip.ru\_4

moschip.ru\_6

moschip.ru\_9