

## BARBARA-WW

~60° wide beam

### TECHNICAL SPECIFICATIONS:

Dimensions	Ø 70.0 mm
Height	44.7 mm
Fastening	glue
ROHS compliant	yes ⓘ

### MATERIAL SPECIFICATIONS:

Component	Type	Material
BARBARA-WW	Reflector	PC



Colour	Finish	Coating
metal		lacquer

### ORDERING INFORMATION:

#### Component





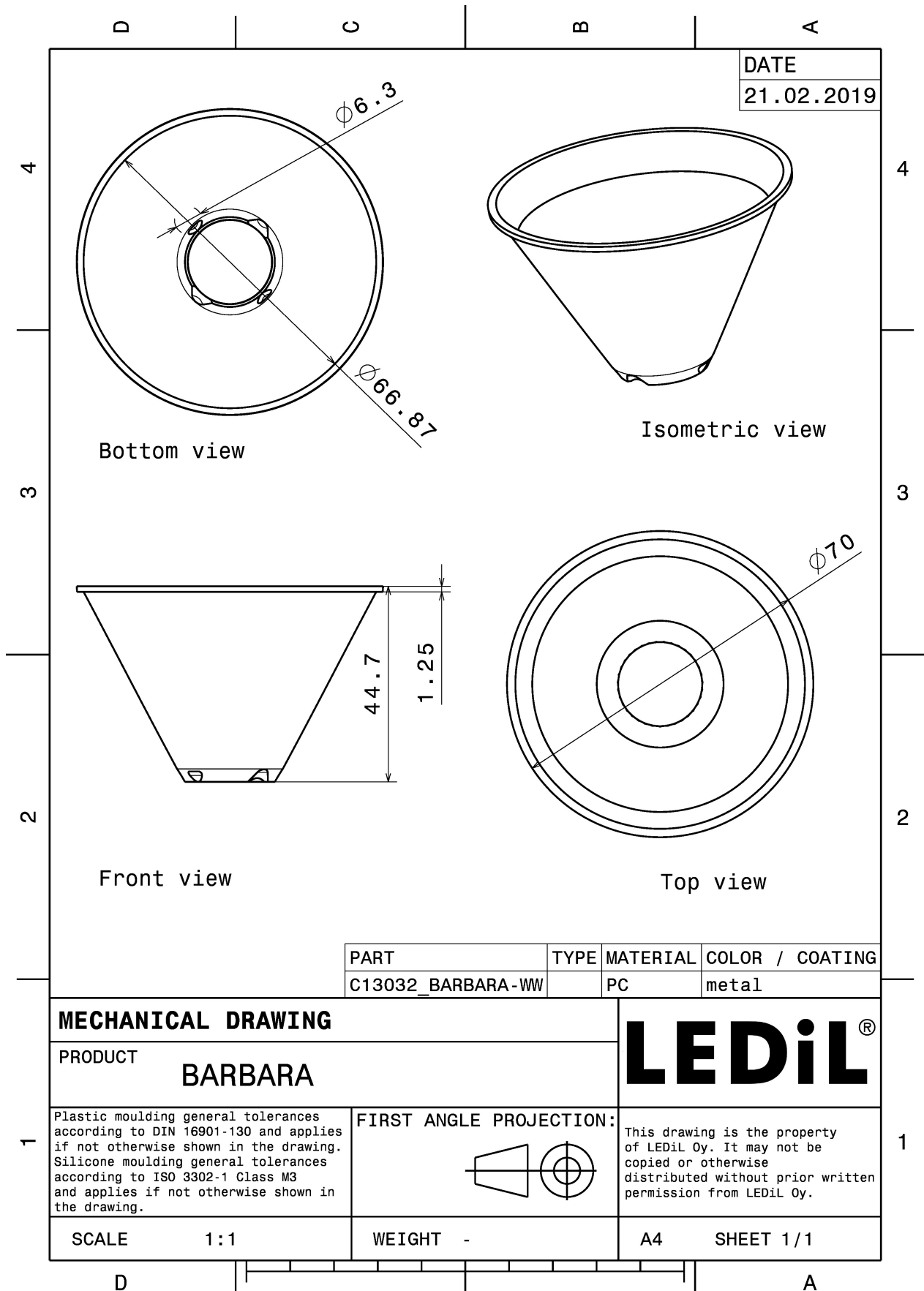

C13032\_BARBARA-WW

» Box size: 476 x 273 x 247 mm

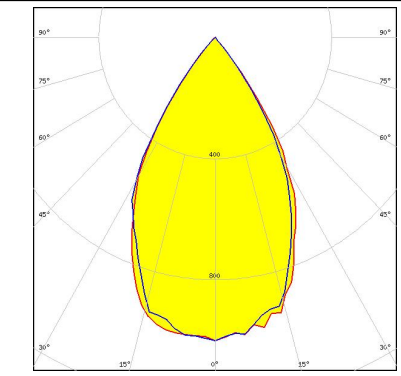
Qty in box	MOQ	MPQ	Box weight (kg)
288	90	18	5.7

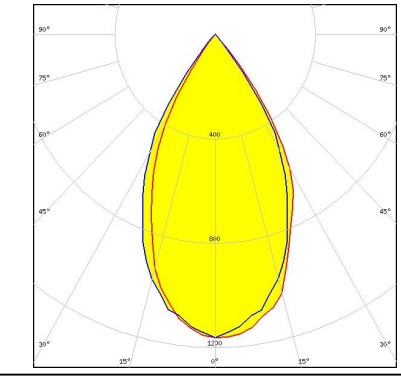

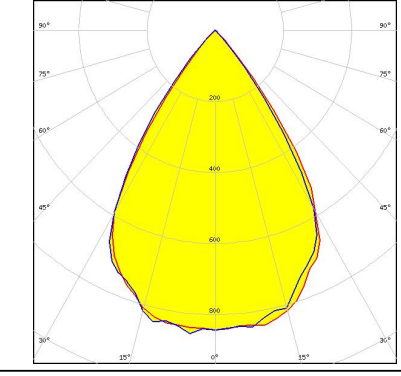
#### PHOTOMETRIC DATA (MEASURED):

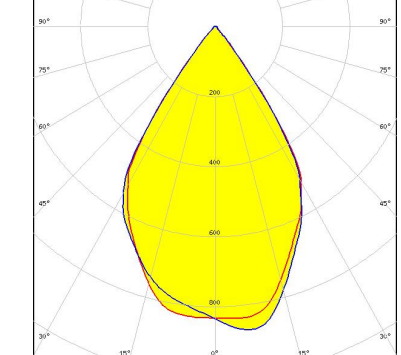
<p>bridgelux.</p> <p>LED BXRA ES Rectangle            FWHM 60.0°            Efficiency 89 %            Peak intensity 1.000 cd/lm            LEDs/each optic 1            Light colour White            Required components:</p>		
<p><b>CITIZEN</b></p> <p>LED CL-L330            FWHM 55.0°            Efficiency 88 %            Peak intensity 1.200 cd/lm            LEDs/each optic 1            Light colour White            Required components:</p>		
<p><b>CITIZEN</b></p> <p>LED CLL03x/CLU03x            FWHM 70.0°            Efficiency 88 %            Peak intensity 0.800 cd/lm            LEDs/each optic 1            Light colour White            Required components:</p>		
<p><b>CITIZEN</b></p> <p>LED CLU720/721            FWHM 66.0°            Efficiency 81 %            Peak intensity 0.870 cd/lm            LEDs/each optic 1            Light colour White            Required components:</p>		

### PHOTOMETRIC DATA (MEASURED):



LED CXA2011  
FWHM 60.0°  
Efficiency 90 %  
Peak intensity 1.000 cd/lm  
LEDs/each optic 1  
Light colour White  
Required components:

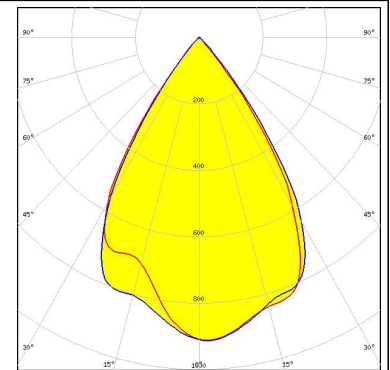

LED COB 10W/13W/17W/24W  
FWHM 65.0°  
Efficiency %  
Peak intensity 0.900 cd/lm  
LEDs/each optic 1  
Light colour White  
Required components:

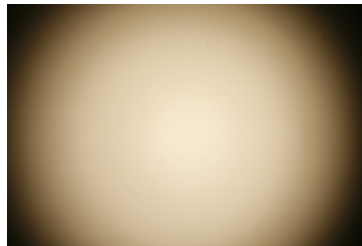

LED CxM-14 (19x19)  
FWHM 68.0°  
Efficiency 80 %  
Peak intensity 0.820 cd/lm  
LEDs/each optic 1  
Light colour White  
Required components:

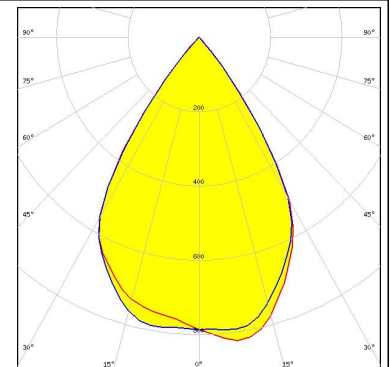
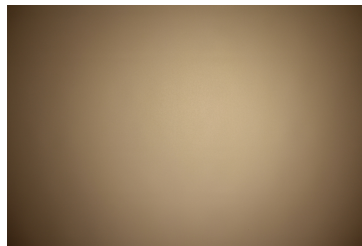

### GENERAL INFORMATION:

NOTE: The typical beam angle will be changed by different color, chip size and chip position tolerance. The typical total beam angle is the full angle measured where the luminous intensity is half of the peak value.

Due to use of high power COB's with this product, special attention to proper thermal design is highly recommended. LEDiL has no liability for direct, indirect or consecutive damages arising from the LEDiL products being used outside of the recommended temperature range.

### MATERIALS:

As part of our continuous research and improvement processes, and to ensure the best possible quality and availability of our products, LEDiL reserves the right to change material grades without notice.

### PRODUCT DATA USER AGREEMENT AND DISCLAIMER:

The measured data in the provided downloadable LEDiL Product Datasheets and Mechanical 2D-Drawings is rounded and provided as reference for planning. LEDiL Oy's optical specifications have been verified by conducting performance testing of the products in accordance with the company's quality system. The reported data are averaged results of multiple measurements with typical variation. LEDiL Oy reserves the right to without prior notification make changes and improvements to its products.

LEDiL Oy assumes neither warranty, nor guarantee nor any other liability of any kind for the contents and correctness of the provided data. The provided data has been generated with highest diligence but the provided data may in reality not represent the complete possible variation range of all intrinsic parameters. Therefore, in certain cases a deviation from the provided data could occur.

LEDiL Oy reserves the right to undertake technical changes of its products without further notification which could lead to changes in the provided data. LEDiL Oy assumes no liability of any kind for the possible deviation from any provided data or any other damage resulting from the usage of the provided data.

The user agrees to this disclaimer and user agreement with the download or usage of the provided files.

#### LEDiL Oy

Joensuunkatu 13  
FI-24240 SALO  
Finland

#### LEDiL Inc.

228 West Page Street  
Suite D  
Sycamore IL 60178  
USA

#### Local sales and technical support

[www.ledil.com/where\\_to\\_buy](http://www.ledil.com/where_to_buy)

#### Shipping locations

Salo, Finland  
Hong Kong, China

#### Distribution Partners

[www.ledil.com/where\\_to\\_buy](http://www.ledil.com/where_to_buy)

## Данный компонент на территории Российской Федерации

### Вы можете приобрести в компании MosChip.

Для оперативного оформления запроса Вам необходимо перейти по данной ссылке:

<http://moschip.ru/get-element>

Вы можете разместить у нас заказ для любого Вашего проекта, будь то серийное производство или разработка единичного прибора.

В нашем ассортименте представлены ведущие мировые производители активных и пассивных электронных компонентов.

Нашей специализацией является поставка электронной компонентной базы двойного назначения, продукции таких производителей как XILINX, Intel (ex.ALTERA), Vicor, Microchip, Texas Instruments, Analog Devices, Mini-Circuits, Amphenol, Glenair.

Сотрудничество с глобальными дистрибьюторами электронных компонентов, предоставляет возможность заказывать и получать с международных складов практически любой перечень компонентов в оптимальные для Вас сроки.

На всех этапах разработки и производства наши партнеры могут получить квалифицированную поддержку опытных инженеров.

Система менеджмента качества компании отвечает требованиям в соответствии с ГОСТ Р ИСО 9001, ГОСТ РВ 0015-002 и ЭС РД 009

### Офис по работе с юридическими лицами:

105318, г.Москва, ул.Щербаковская д.3, офис 1107, 1118, ДЦ «Щербаковский»

Телефон: +7 495 668-12-70 (многоканальный)

Факс: +7 495 668-12-70 (доб.304)

E-mail: [info@moschip.ru](mailto:info@moschip.ru)

Skype отдела продаж:

moschip.ru

moschip.ru\_4

moschip.ru\_6

moschip.ru\_9