

REV.	DESCRIPTION	DATE	APPROVED
C	Engineering Update w/o Changes	03/10/04	M. C.
D	Corrected Typos.	08/19/04	M. C.
E	Included Charts as Page 3, 4 & 5.	10/21/04	M. C.
F	Changed Storage & Operating Lower Temperature to -40.	11/02/04	M. C.
G	Image Orientation Update w/o Changes	02/28/05	M. C.
H	Added SM2-PGC-20 LED	09/29/06	M. C.

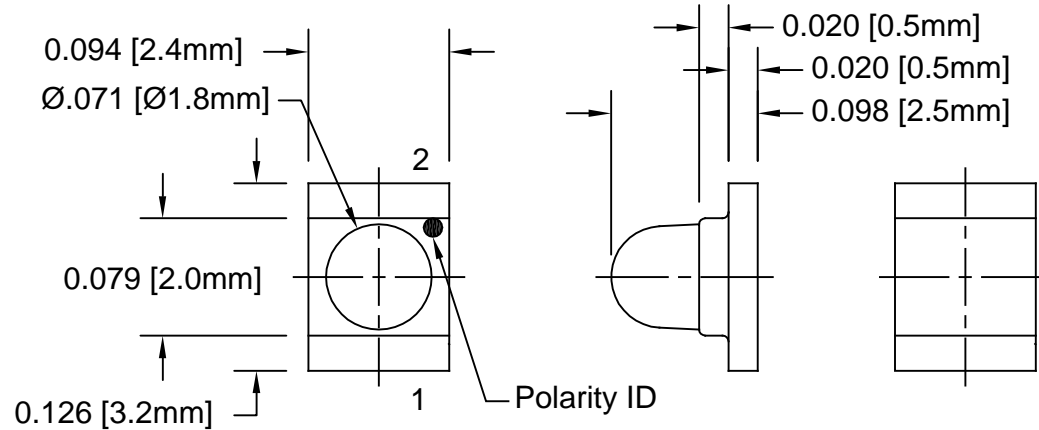

SM2-XXXX-20

*REVERSE POLARITY



SM2-XXXX-20

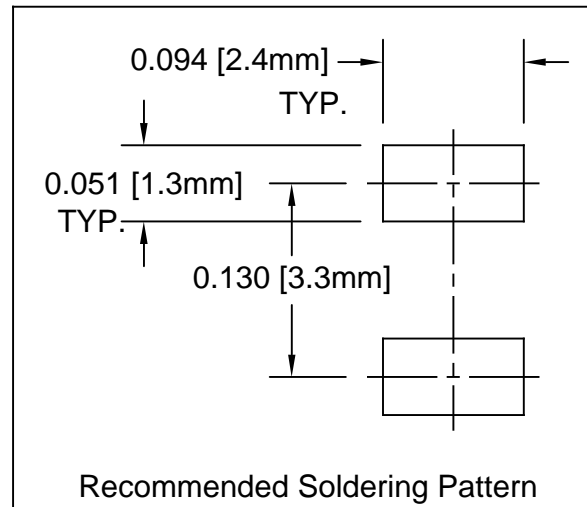

ABSOLUTE MAXIMUM RATINGS (Ta=25° C)



REVERSE VOLTAGE	_____	5V
REVERSE CURRENT	_____	100uA
OPERATING TEMPERATURE RANGE	_____	-40° C - 85° C
STORAGE TEMPERATURE	_____	-40° C - 100° C
LEAD SOLDERING TEMPERATURE(1/16" FROM BODY)	_____	260° C FOR 5 SECONDS

STANDARD TOLERANCE (UNLESS OTHERWISE SPECIFIED)		 4 THOMAS, IRVINE, CA. 92618 TEL: (949) 951-8808 FAX: (949) 951-3974	
DECIMALS	ANGULAR		
.X ±.1	X° ±1°		
.XX ±.02		 TITLE: SURFACE MOUNT LED, 1.8mm DOMED LENS	
.XXX ±.010			
DESIGNED: David Green	DATE: 10/21/02	PART NO: SM2-XXXX-20 REVISION: H	
CHECKED: M. Chen	DATE: 10/21/02		
		CAGE CODE : 32559 SHEET # 1 OF 6	
CAD GENERATED DOCUMENT, DO NOT MEASURE DRAWING.			

REV.	DESCRIPTION	DATE	APPROVED
	SEE SHEET#1.		

LED Part No.	Chip			Lens Appearance	Absolute Max. Ratings				Electro-Optical Data @ 20mA			Viewing Angle 2θ ½ (Deg)
	Material	Peak Wave Length λp(nm)	Emitted Color		Δλ (nm)	Pd (mW)	If (mA)	Peak If(mA)	Vf (V)		Iv (mcd)	
									TYP	MAX	TYP	
SM2-SBWC-20	GaN/Sic	430	SUPER BLUE	WATER CLEAR	60	150	30	150	4.0	4.5	64	20
SM2-UBWC-20	GaN	460	ULTRA BLUE	WATER CLEAR	68	150	30	150	3.4	4.0	288	20
SM2-UTC-20	InGaN	505	ULTRA TURQUOISE	WATER CLEAR	37	150	30	150	3.3	4.0	960	20
SM2-PGC-20	InGaN/SiC	510	GREEN	WATER CLEAR	20	120	30	125	3.5	4.0	900	20
SM2-UGC-20	InGaN	525	ULTRA GREEN	WATER CLEAR	40	150	30	150	3.2	3.8	960	20
SM2-GC-20	GaP	565	GREEN	WATER CLEAR	32	100	30	150	2.3	2.7	136	20
SM2-SGC-20	AlGaN	575	GREEN	WATER CLEAR	18	100	30	150	2.1	2.6	296	20
SM2-YC-20	GaAsP	586	YELLOW	WATER CLEAR	37	100	30	150	2.1	2.5	49	20
SM2-UYC-20	AlGaN	595	YELLOW	WATER CLEAR	32	100	30	150	2.0	2.5	456	20
SM2-UAC-20	AlGaN	600	AMBER	WATER CLEAR	20	100	30	150	1.9	2.4	600	20
SM2-SAC-20	AlGaN	610	AMBER	WATER CLEAR	25	100	30	150	1.9	2.4	416	20
SM2-UOC-20	AlGaN	620	ORANGE	WATER CLEAR	18	100	30	150	1.9	2.4	600	20
SM2-UHC-20	AlGaN	635	HE RED	WATER CLEAR	25	100	30	150	1.9	2.4	536	20
SM2-SHC-20	AlGaN	640	RED	WATER CLEAR	23	80	30	150	1.9	2.4	416	20
SM2-ERC-20*	GaAlAs	660	RED	WATER CLEAR	25	80	30	150	1.8	2.3	152	20
SM2-UWC-20	GaN	X=.29 Y=.30	WHITE	WATER CLEAR	-	150	30	150	3.4	4.0	250	60



*ERC CHIP REVERSED POLARITY

STANDARD TOLERANCE (UNLESS OTHERWISE SPECIFIED) ±10% ALL VALUES ANGULAR X° ± 5°		 4 THOMAS, IRVINE, CA. 92618 TEL: (949) 951-8808 FAX: (949) 951-3974	
			
DESIGNED: David Green	DATE: 10/21/02	PART NO: SM2-XXXX-20	REVISION: H
CHECKED: M. Chen	DATE: 10/21/02		CAGE CODE : 32559 SHEET # 2 OF 6
CAD GENERATED DOCUMENT, DO NOT MEASURE DRAWING.			

REV.	DESCRIPTION	DATE	APPROVED
	SEE SHEET#1.		

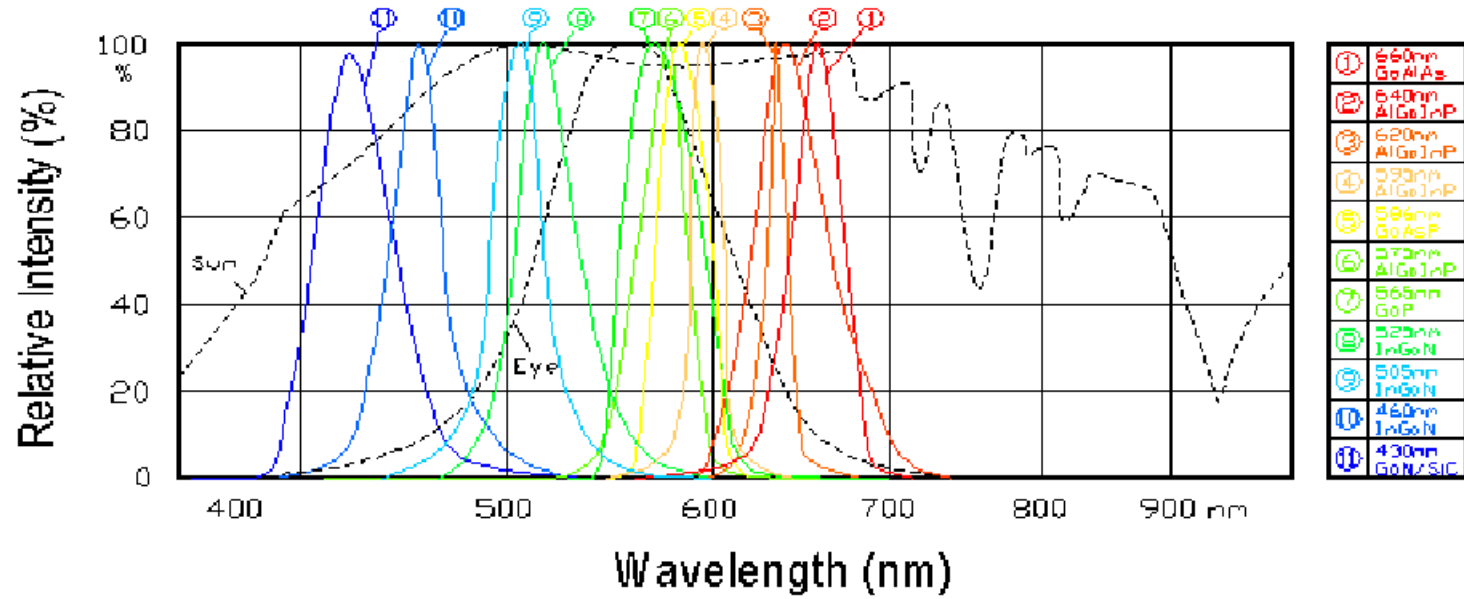
Relative Intensity vs. Wavelength



STANDARD TOLERANCE (UNLESS OTHERWISE SPECIFIED) ±10% ALL VALUES		 BIVAR [®] 4 THOMAS, IRVINE, CA. 92618 TEL: (949) 951-8808 FAX: (949) 951-3974		
ANGULAR X° ± 5°				
		TITLE: SURFACE MOUNT LED, 1.8mm DOMED LENS		
		DESIGNED: David Green	DATE: 10/21/02	PART NO: SM2-XXXX-20
CHECKED: M. Chen		DATE: 10/21/02	CAGE CODE : 32559 SHEET # 3 OF 6	
CAD GENERATED DOCUMENT, DO NOT MEASURE DRAWING.				

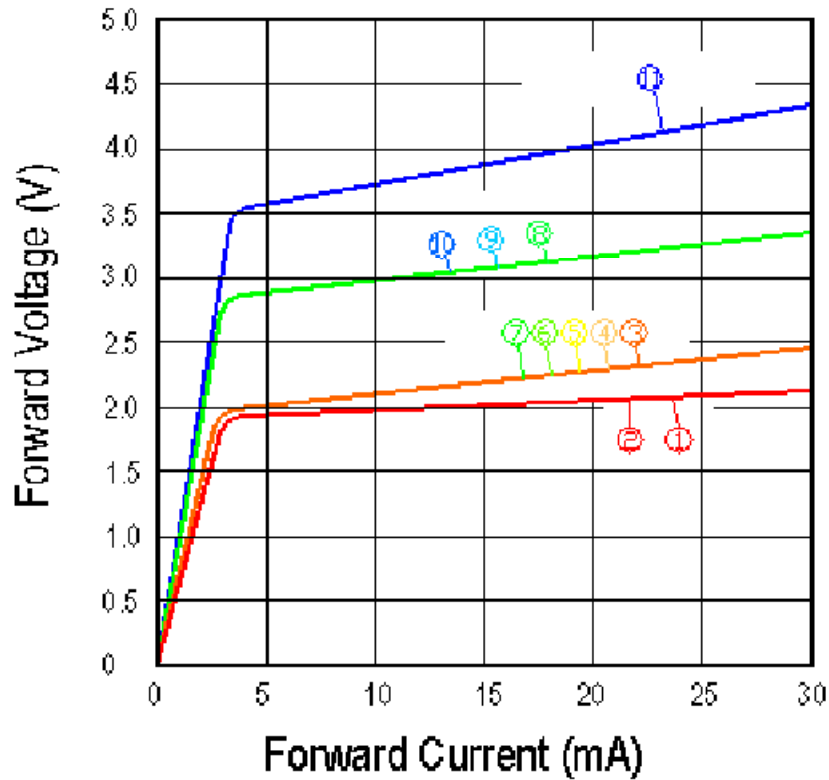

REV.	DESCRIPTION	DATE	APPROVED
	SEE SHEET#1.		

Forward Voltage vs. Forward Current

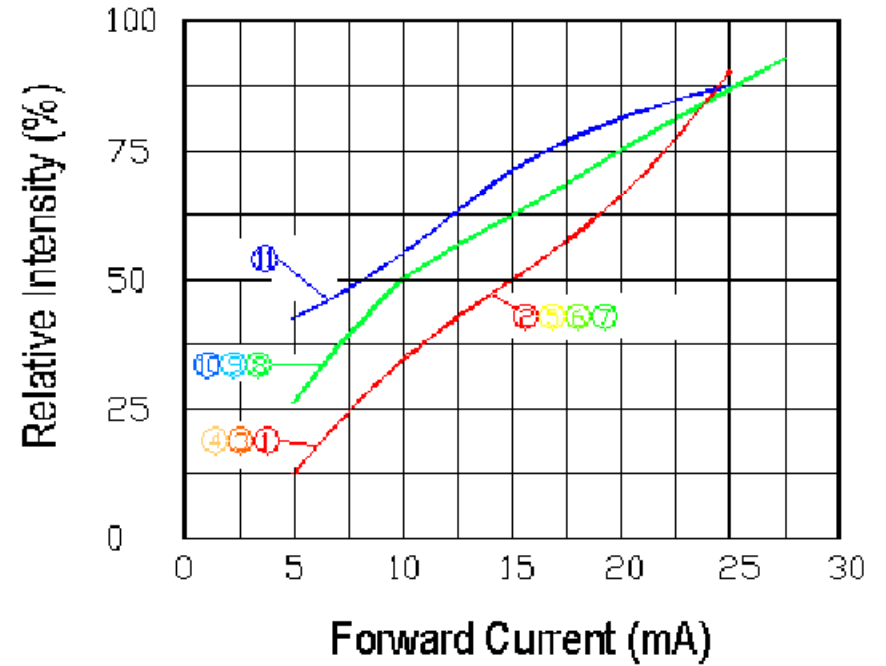

Relative Intensity vs. Forward Current



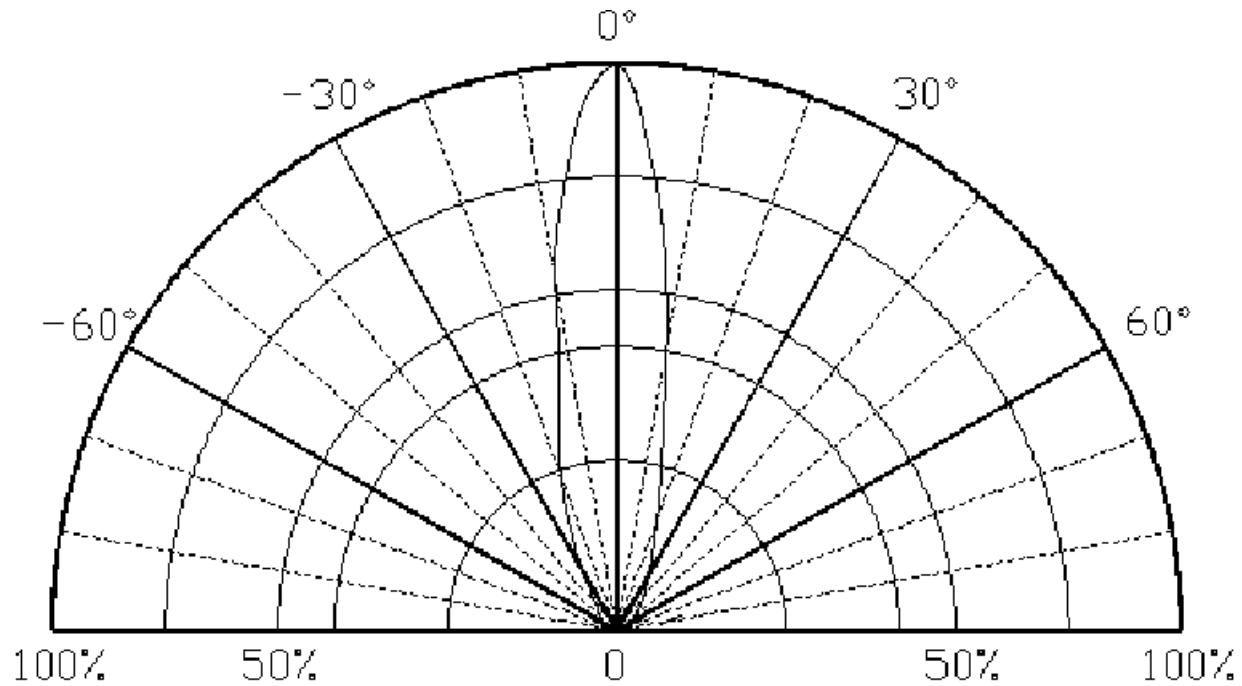

STANDARD TOLERANCE (UNLESS OTHERWISE SPECIFIED) ±10% ALL VALUES ANGULAR X° ± 5°		 4 THOMAS, IRVINE, CA. 92618 TEL: (949) 951-8808 FAX: (949) 951-3974		
				TITLE: SURFACE MOUNT LED, 1.8mm DOMED LENS
DESIGNED: David Green	DATE: 10/21/02	PART NO: SM2-XXXX-20	REVISION: H	
CHECKED: M. Chen	DATE: 10/21/02		CAGE CODE : 32559 SHEET # 4 OF 6	CAD GENERATED DOCUMENT, DO NOT MEASURE DRAWING.

REV.	DESCRIPTION	DATE	APPROVED
	SEE SHEET#1.		



Directive Characteristics

STANDARD TOLERANCE (UNLESS OTHERWISE SPECIFIED) ±10% ALL VALUES		ANGULAR X° ± 5°	
		 4 THOMAS, IRVINE, CA. 92618 TEL: (949) 951-8808 FAX: (949) 951-3974	
		 TITLE: SURFACE MOUNT LED, 1.8mm DOMED LENS	
DESIGNED: David Green	DATE: 10/21/02	PART NO: SM2-XXXX-20	REVISION: H
CHECKED: M. Chen	DATE: 10/21/02	CAGE CODE : 32559	SHEET # 5 OF 6
CAD GENERATED DOCUMENT. DO NOT MEASURE DRAWING.			

REV.	DESCRIPTION	DATE	APPROVED
	See Sheet #1.		

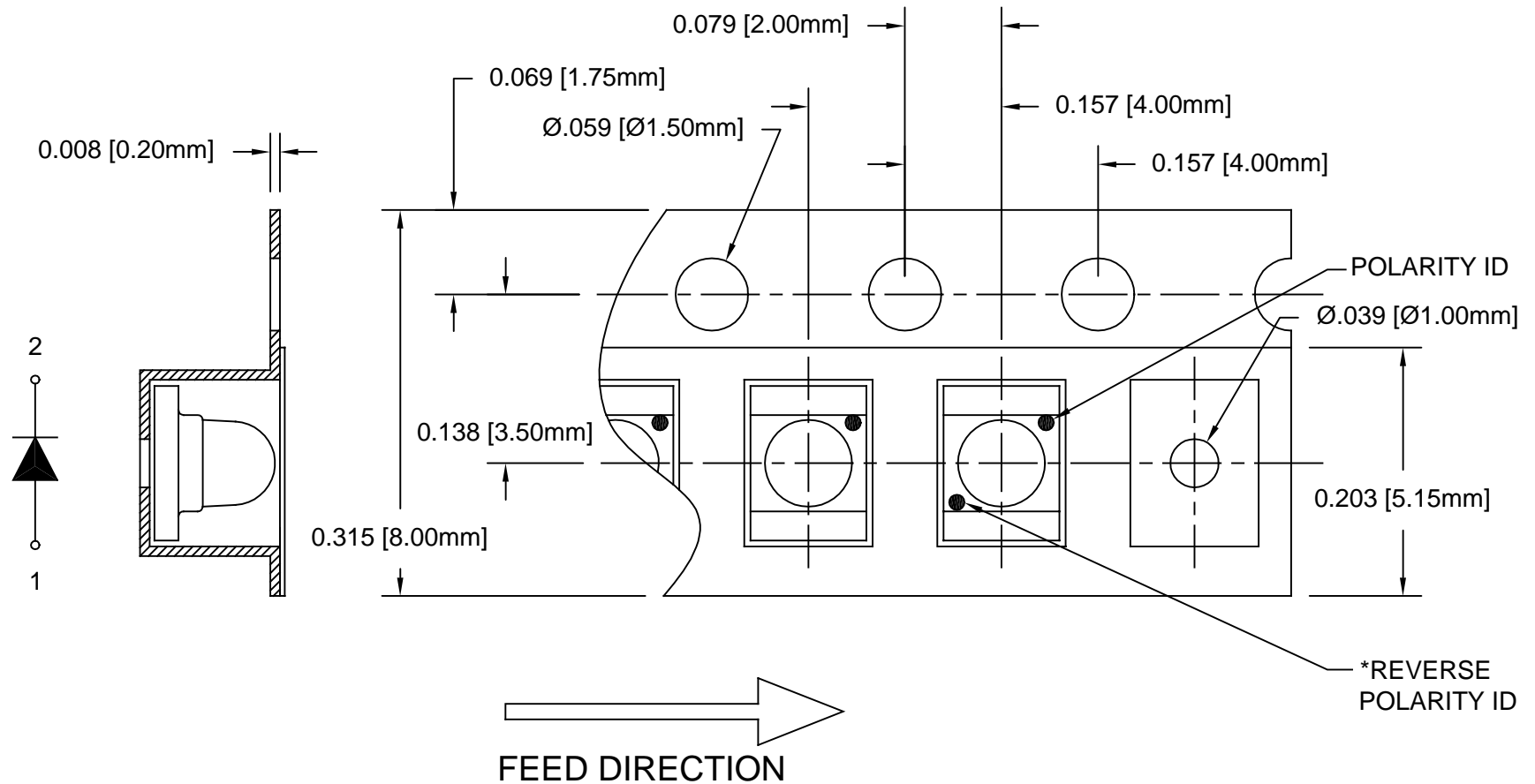

2. UNLESS OTHERWISE SPECIFIED,
 PACKAGING TO COMPLY WITH EIA-481
 1. 1500 pcs PER REEL

STANDARD TOLERANCE (UNLESS OTHERWISE SPECIFIED)		BIVAR®	
DECIMALS	ANGULAR	4 THOMAS, IRVINE, CA. 92618	
.X ± .1	X° ± 1°	TEL: (949) 951-8808 FAX: (949) 951-3974	
.XX ± .02		TITLE: SURFACE MOUNT LED, 1.8mm DOMED LENS	
.XXX ± .010		PART NO: SM2-XXXX-20	
DESIGNED: David Green	DATE: 10/21/02	REVISION: H	
CHECKED: M. Chen	DATE: 10/21/02	CAGE CODE : 32559 SHEET # 6 OF 6	
CAD GENERATED DOCUMENT, DO NOT MEASURE DRAWING.			

Данный компонент на территории Российской Федерации

Вы можете приобрести в компании MosChip.

Для оперативного оформления запроса Вам необходимо перейти по данной ссылке:

<http://moschip.ru/get-element>

Вы можете разместить у нас заказ для любого Вашего проекта, будь то серийное производство или разработка единичного прибора.

В нашем ассортименте представлены ведущие мировые производители активных и пассивных электронных компонентов.

Нашей специализацией является поставка электронной компонентной базы двойного назначения, продукции таких производителей как XILINX, Intel (ex.ALTERA), Vicor, Microchip, Texas Instruments, Analog Devices, Mini-Circuits, Amphenol, Glenair.

Сотрудничество с глобальными дистрибьюторами электронных компонентов, предоставляет возможность заказывать и получать с международных складов практически любой перечень компонентов в оптимальные для Вас сроки.

На всех этапах разработки и производства наши партнеры могут получить квалифицированную поддержку опытных инженеров.

Система менеджмента качества компании отвечает требованиям в соответствии с ГОСТ Р ИСО 9001, ГОСТ РВ 0015-002 и ЭС РД 009

Офис по работе с юридическими лицами:

105318, г.Москва, ул.Щербаковская д.3, офис 1107, 1118, ДЦ «Щербаковский»

Телефон: +7 495 668-12-70 (многоканальный)

Факс: +7 495 668-12-70 (доб.304)

E-mail: info@moschip.ru

Skype отдела продаж:

moschip.ru

moschip.ru_4

moschip.ru_6

moschip.ru_9