

## SILICON RFIC LOW CURRENT AMPLIFIER FOR CELLULAR/CORDLESS TELEPHONES

### FEATURES

- **SUPPLY VOLTAGE:**  $V_{CC} = 2.4$  to  $3.3$  V
- **LOW CURRENT CONSUMPTION:**  
UPC8151TB;  $I_{CC} = 4.2$  mA TYP @  $3.0$  V
- **HIGH EFFICIENCY:**  
UPC8151TB;  $P_{1dB} = +2.5$  dBm TYP @  $f = 1$  GHz
- **POWER GAIN:**  
UPC8151TB;  $G_P = 12.5$  dB TYP @  $f = 1$  GHz
- **OPERATING FREQUENCY:**  
100 MHz to 1900 MHz (Output port LC matching)
- **EXCELLENT ISOLATION:**  
UPC8151TB;  $ISOL = 38$  dB TYP @  $f = 1$  GHz
- **HIGH DENSITY SURFACE MOUNTING:**  
6 pin super minimold or SOT-363 package

### DESCRIPTION

The UPC8151TB is a silicon RFIC designed as a buffer amplifier for cellular or cordless telephones. This low current amplifier operates on  $3.0$  V and is housed in a 6 pin super minimold package.

The IC is manufactured using the 20 GHz ft NESAT™ III silicon bipolar process. This process uses silicon nitride passivation film and gold electrodes. These materials protect the chip surface from external pollution and prevent corrosion/migration. Thus, this IC has excellent performance, uniformity and reliability.

INSERTION POWER GAIN vs.  
FREQUENCY AND VOLTAGE

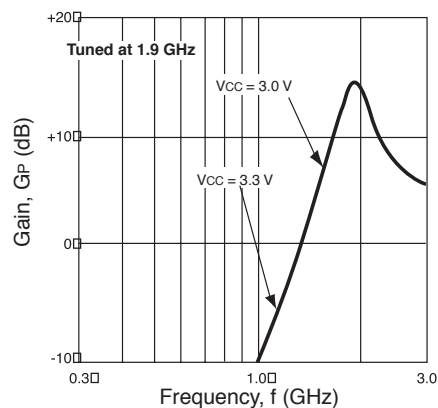
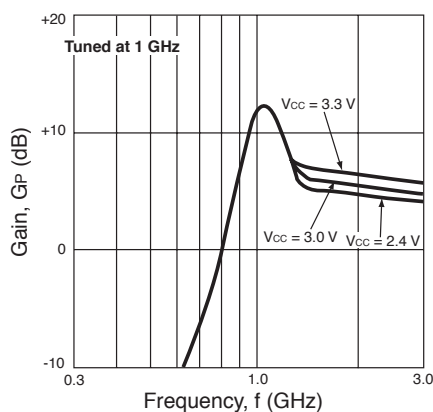

### ELECTRICAL CHARACTERISTICS (TA = 25 °C, VCC = VOUT = 3.0 V, ZL = ZS = 50 Ω, at LC matched frequency)

PART NUMBER PACKAGE OUTLINE			UPC8151TB SO6		
SYMBOLS	PARAMETERS AND CONDITIONS	UNITS	MIN	TYP	MAX
I <sub>CC</sub>	Circuit Current, No signal	mA	2.8	4.2	5.8
G <sub>P</sub>	Power Gain f = 1.00 GHz f = 1.90 GHz	dB	9.5 12.0	12.5 15.0	14.5 17.0
ISOL	Isolation f = 1.00 GHz f = 1.90 GHz	dB	33.0 29.0	38.0 34.0	– –
P <sub>1dB</sub>	Output Power at 1 dB Compression Point f = 1.00 GHz f = 1.90 GHz	dBm	-1.0 -3.0	+2.5 +0.5	– –
NF	Noise Figure f = 1.00 GHz f = 1.90 GHz	dB	– –	6.0 6.0	7.5 7.5
RL <sub>IN</sub>	Input Return Loss(without matching circuit) f = 1.00 GHz f = 1.90 GHz	dB	2.0 1.0	5.0 4.0	– –
RL <sub>OUT</sub>	Output Return Loss (with external matching circuit) f = 1.00 GHz f = 1.90 GHz	dB		10.0 12.0	
IM <sub>3</sub>	3rd Order Intermodulation Distortion f <sub>1</sub> = 1.000 GHz, f <sub>2</sub> = 1.001 GHz, P <sub>O(each)</sub> = -20 dBm f <sub>1</sub> = 1.900 GHz, f <sub>2</sub> = 1.901 GHz, P <sub>O(each)</sub> = -20 dBm	dBc		-62.0 54.0	

**ABSOLUTE MAXIMUM RATINGS<sup>1</sup>** (T<sub>A</sub> = 25°C)

SYMBOLS	PARAMETERS	UNITS	RATINGS
V <sub>CC</sub>	Supply Voltage	V	3.6
P <sub>D</sub>	Total Power Dissipation <sup>2</sup>	mW	200
T <sub>A</sub>	Operating Temperature	°C	-40 to +85
T <sub>STG</sub>	Storage Temperature	°C	-55 to +150

Notes:

1. Operation in excess of any one of these parameters may result in permanent damage.
2. Mounted on a 50 x 50 x 1.6 mm epoxy glass PWB (T<sub>A</sub> = 85°C).

**RECOMMENDED OPERATING CONDITIONS**

SYMBOLS	PARAMETERS	UNITS	MIN	TYP	MAX
V <sub>CC</sub>	Supply Voltage	V	2.4	3.0	3.3
T <sub>A</sub>	Operating Temperature	°C	-40	+25	+85
f	Operating Frequency	MHz	100		1900

**PIN FUNCTIONS**

Pin No.	Symbol	Applied Voltage	Description	Internal Equivalent Circuit
1	INPUT		Signal input pin. An internal matching circuit provides a 50 Ω match over a wide bandwidth. This pin must be coupled to signal source with a blocking capacitor.	
4	OUTPUT	V <sub>CC</sub> through external inductor.	Signal output pin. This output is designed as an open collector. Due to the high impedance output this pin should be externally equipped with an LC matching circuit.	
6	V <sub>CC</sub>	2.4 to 3.3	Power supply pin. This pin should be externally equipped with a bypass capacitor to minimize ground impedance.	
2 3 5	GND	0	Ground pin. This pin should be connected to system ground with minimum inductance. Ground pattern on the board should be formed as wide as possible. All the ground pins must be connected together with wide ground pattern to minimize impedance difference.	

## TYPICAL APPLICATION EXAMPLE

Location Examples in Digital Cellular

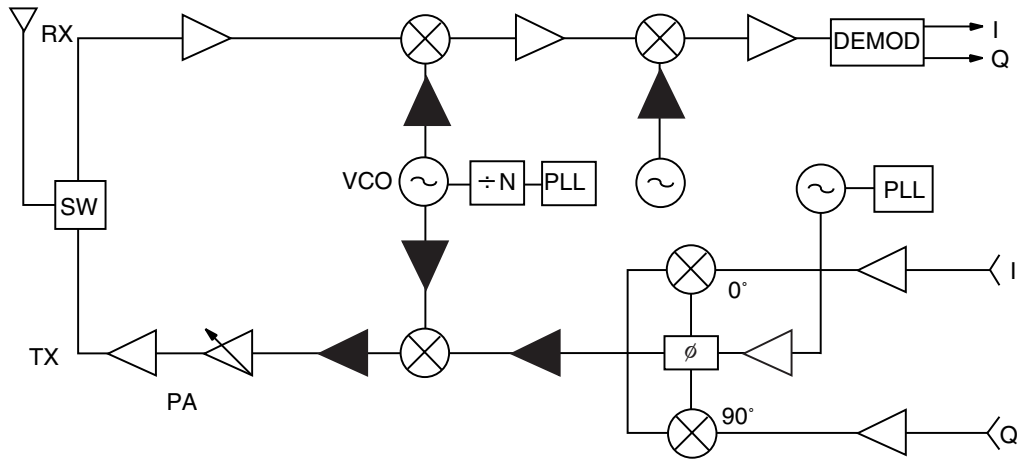

### PRODUCT LINE-UP (TA = +25 °C, VCC = 3.0 V, ZL = ZS = 50 Ω)

PARAMETER PART NO.	I <sub>CC</sub> (mA)	OUTPUT PORT MATCHING FREQUENCY						PACKAGES
		1 GHz			1.9 GHz			
		G <sub>P</sub> (dB)	ISOL (dB)	P <sub>1dB</sub> (dBm)	G <sub>P</sub> (dB)	ISOL (dB)	P <sub>1dB</sub> (dBm)	
UPC8128TB	2.8	12.5	39	-4.0	13.0	37	-4.0	6 pin super minimold
UPC8151TB	4.5	12.5	38	+2.5	15.0	34	+0.5	6 pin super minimold
UPC8152TB	5.6	23.0	40	-4.5	17.5	35	-8.5	6 pin super minimold

### TYPICAL PERFORMANCE CURVES (TA = 25°C unless otherwise specified)

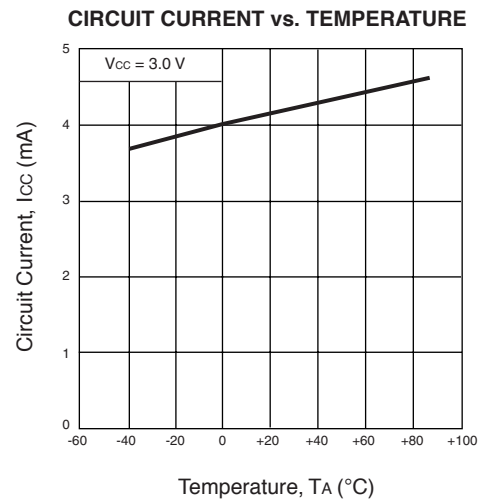
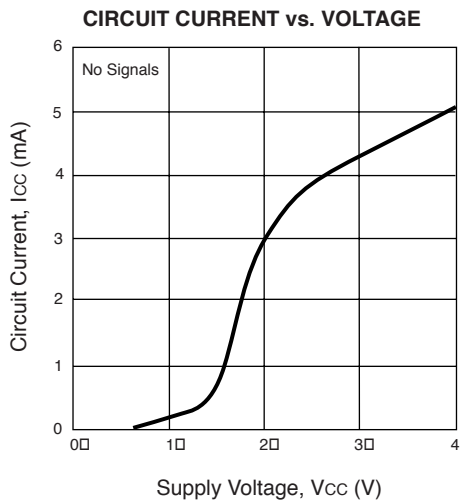

**TYPICAL PERFORMANCE CURVES** ( $T_A = 25^\circ\text{C}$  unless otherwise specified)

**1.0 GHz OUTPUT PORT MATCHING**

**INSERTION POWER GAIN vs. FREQUENCY AND VOLTAGE**

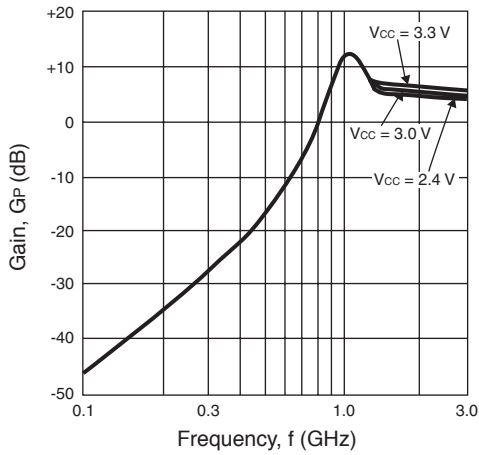

**INSERTION POWER GAIN vs. FREQUENCY AND TEMPERATURE**

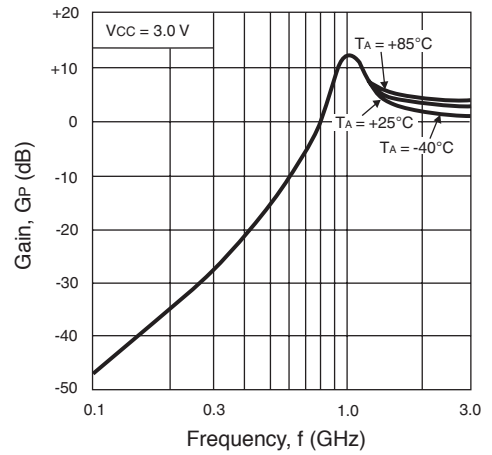

**ISOLATION vs. FREQUENCY AND VOLTAGE**

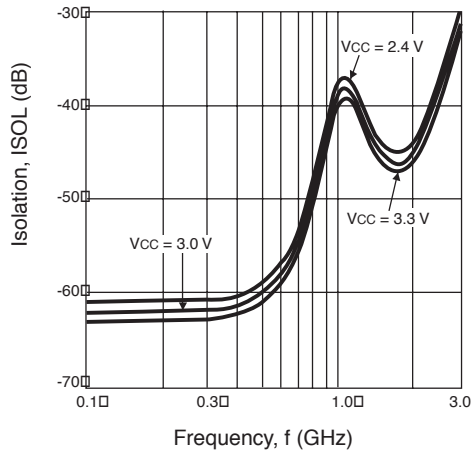

**ISOLATION vs. FREQUENCY AND TEMPERATURE**

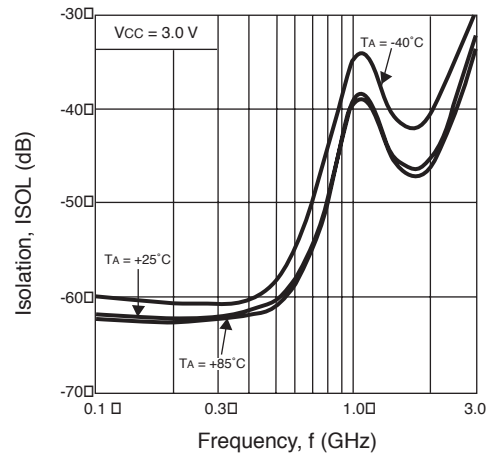

**INPUT RETURN LOSS vs. FREQUENCY AND VOLTAGE**

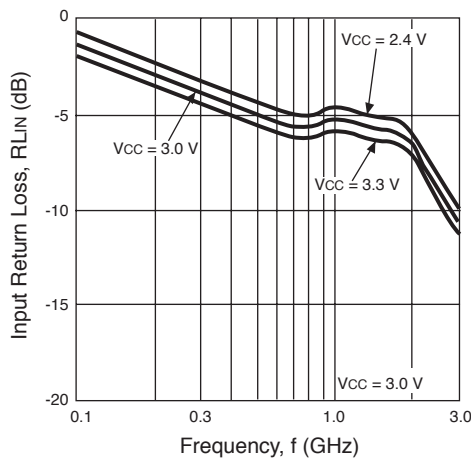

**INPUT RETURN LOSS vs. FREQUENCY AND TEMPERATURE**

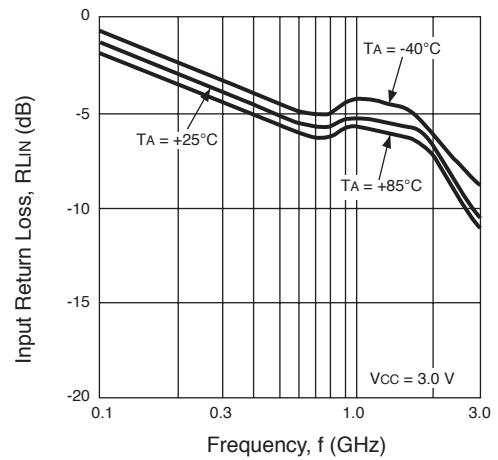

**TYPICAL PERFORMANCE CURVES** (TA = 25°C unless otherwise specified)

**1.0 GHz OUTPUT PORT MATCHING**

**OUTPUT RETURN LOSS vs. FREQUENCY AND VOLTAGE**

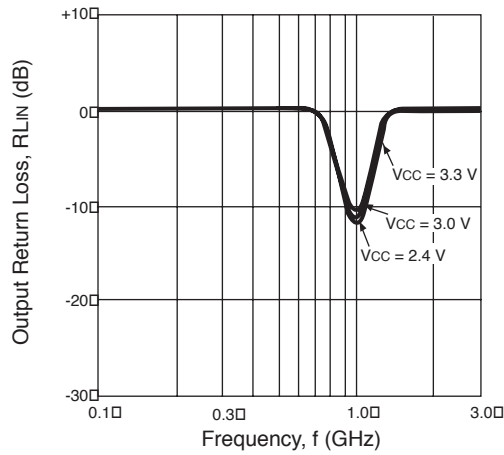

**OUTPUT RETURN LOSS vs. FREQUENCY AND TEMPERATURE**

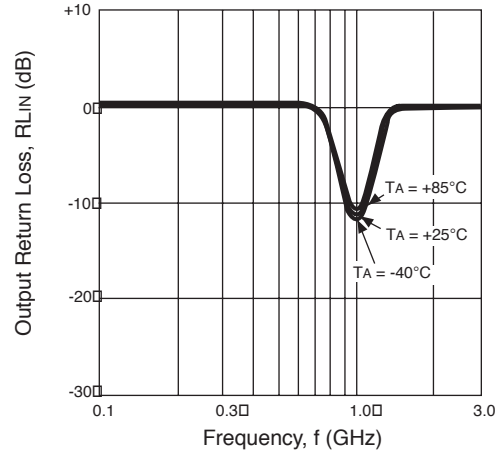

**OUTPUT POWER vs. INPUT POWER AND VOLTAGE**

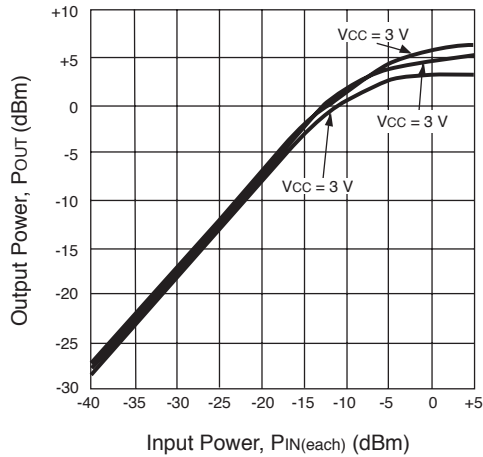

**OUTPUT POWER vs. INPUT POWER AND TEMPERATURE**

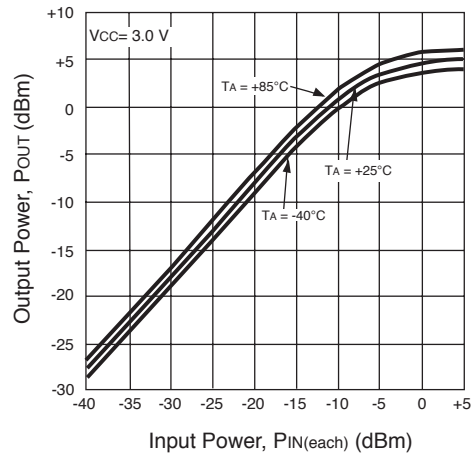

**OUTPUT POWER OF EACH TONE AND 3rd ORDER INTERMODULATION DISTORTION vs. INPUT POWER OF EACH TONE**

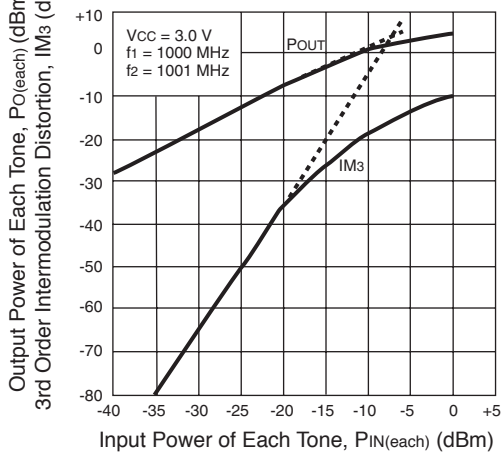

**3rd ORDER INTERMODULATION DISTORTION vs. OUTPUT POWER OF EACH TONE AND VOLTAGE**

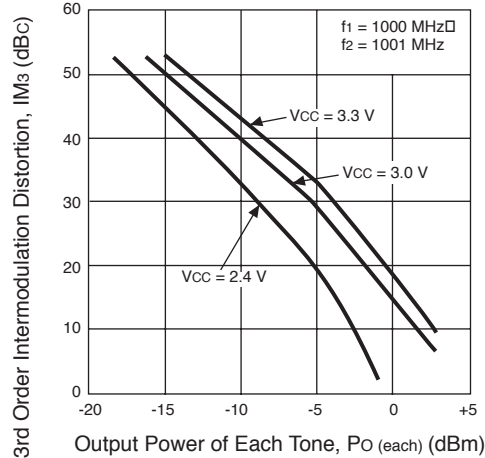

**TYPICAL PERFORMANCE CURVES** (TA = 25°C unless otherwise specified)

**1.0 GHz Output Port Matching**

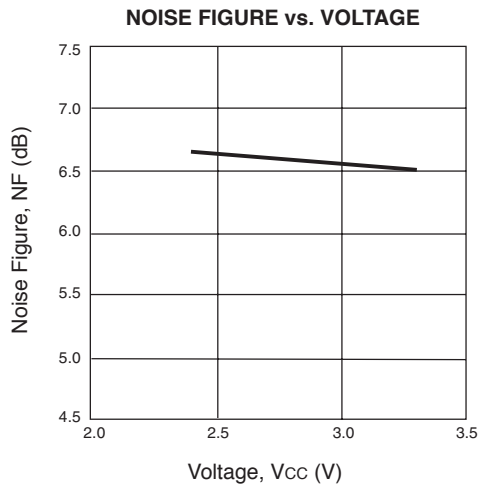

**1.9 GHz Output Port Matching**

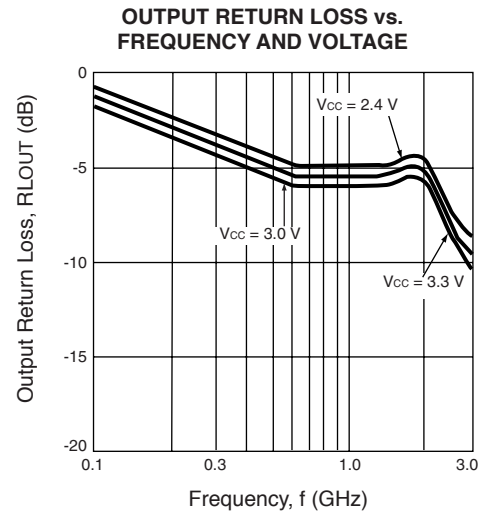
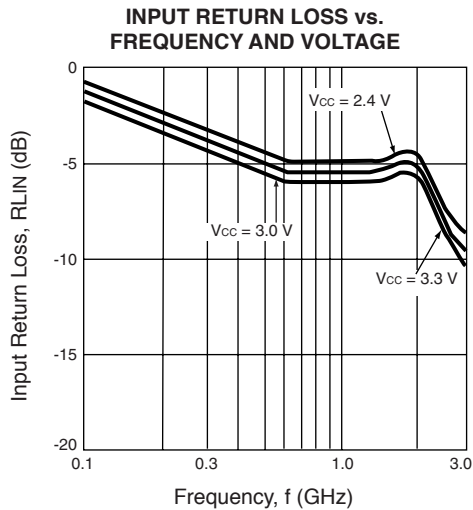
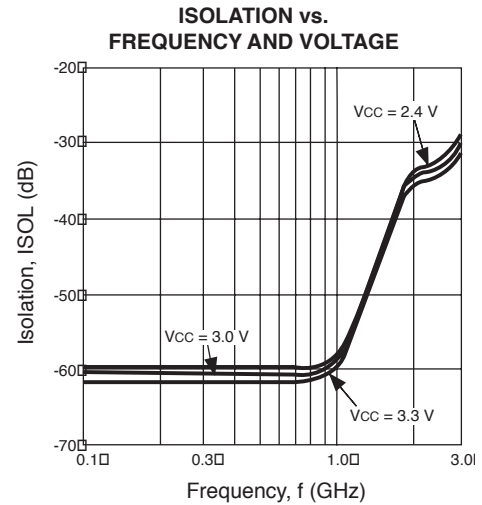
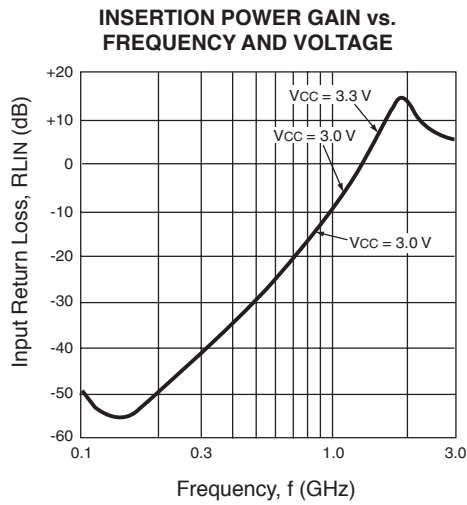

**TYPICAL PERFORMANCE CURVES** (TA = 25°C unless otherwise specified)

**1.9 GHz Output Port Matching**

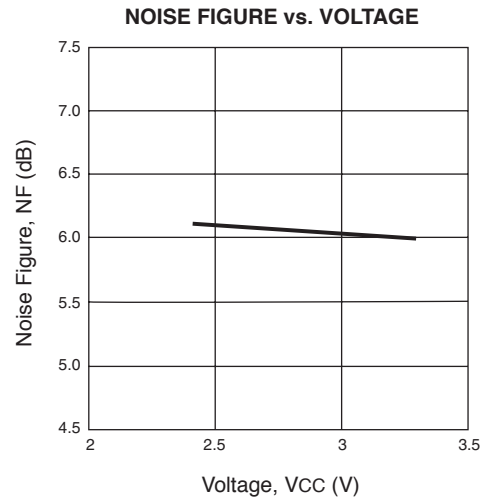
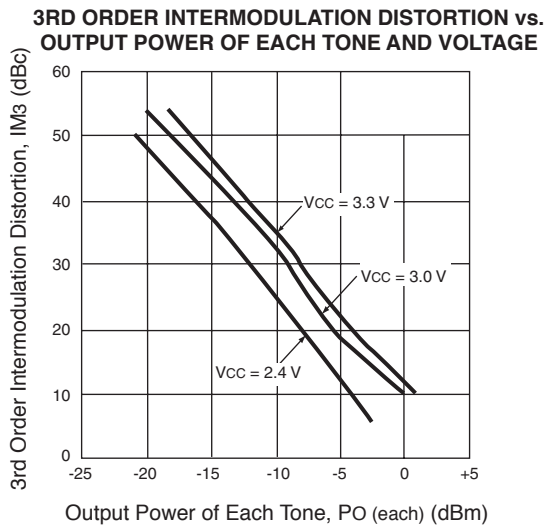
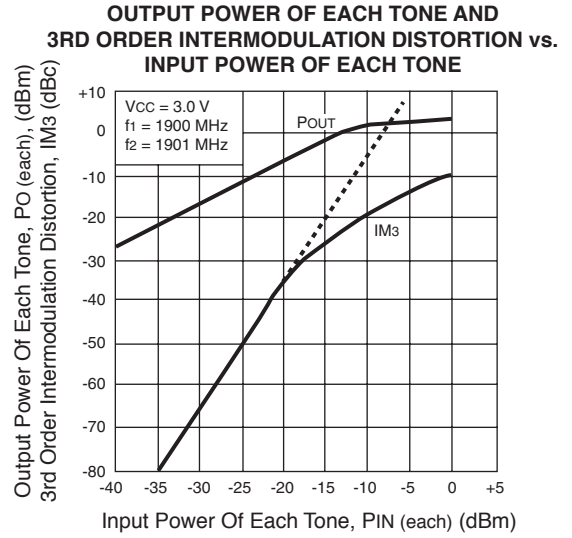
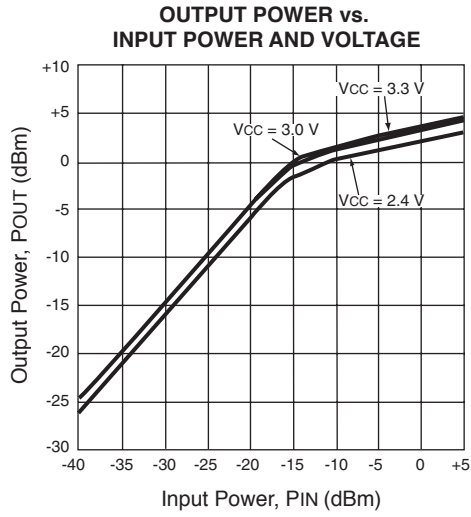

**TYPICAL SCATTERING PARAMETERS** (TA = 25°C)

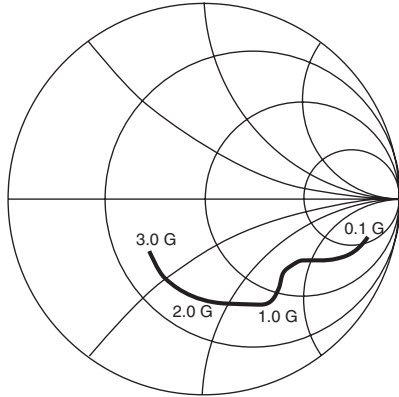

S11—Frequency

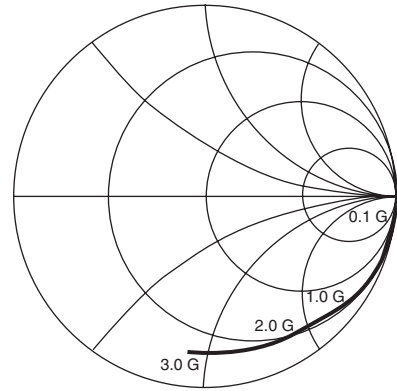

S22—Frequency

Vcc = Vout = 3.0 V, Icc = 4.2 mA

FREQUENCY MHz	S11		S21		S12		S22	
	MAG	ANG	MAG	ANG	MAG	ANG	MAG	ANG
100	.843	-16.0	1.202	-178.9	.000	69.5	.996	-3.3
200	.752	-27.1	1.197	-177.5	.003	120.2	1.009	-6.9
300	.666	-32.4	1.221	-175.4	.003	103.2	.998	-9.9
400	.603	-36.8	1.299	-174.5	.004	92.8	.986	-13.8
500	.555	-40.5	1.398	-174.0	.005	88.8	.968	-17.3
600	.528	-44.8	1.513	-174.9	.005	95.2	.968	-20.4
700	.517	-49.9	1.691	-176.2	.007	67.5	.971	-23.1
800	.525	-54.4	1.815	-178.2	.007	72.4	.972	-25.8
900	.545	-58.9	2.008	179.5	.006	84.5	.960	-29.3
1000	.571	-62.8	2.189	175.7	.009	78.3	.936	-32.8
1100	.580	-67.3	2.399	171.2	.007	60.0	.926	-36.3
1200	.588	-71.3	2.560	165.9	.007	89.5	.933	-39.5
1300	.571	-76.4	2.736	157.5	.008	67.2	.941	-42.0
1400	.563	-82.3	2.865	151.3	.008	79.6	.930	-45.0
1500	.553	-88.8	2.946	143.3	.006	79.9	.906	-48.1
1600	.552	-95.2	3.077	137.0	.006	91.4	.895	-51.5
1700	.551	-101.5	3.083	130.1	.009	102.3	.888	-54.8
1800	.550	-107.5	3.174	123.9	.009	100.5	.884	-57.3
1900	.536	-113.3	3.164	117.4	.006	109.5	.885	-60.5
2000	.517	-119.8	3.193	110.7	.009	115.9	.881	-63.4
2100	.495	-127.1	3.149	104.4	.010	124.2	.870	-66.6
2200	.484	-135.3	3.143	97.3	.011	122.4	.867	-69.8
2300	.484	-142.6	3.135	90.5	.012	131.7	.866	-72.3
2400	.490	-148.5	3.120	83.5	.015	138.1	.868	-75.5
2500	.499	-152.5	3.053	78.4	.016	136.3	.866	-78.7
2600	.499	-155.8	2.991	71.4	.018	142.9	.864	-82.5
2700	.485	-157.4	2.958	68.0	.018	143.9	.858	-86.6
2800	.464	-160.6	2.810	62.9	.021	142.5	.852	-89.7
2900	.439	-164.1	2.866	57.5	.022	149.3	.872	-93.4
3000	.416	-168.6	2.713	54.5	.025	148.4	.864	-96.6
3100	.403	-173.6	2.635	48.0	.030	143.6	.867	-101.0



**OUTLINE DIMENSIONS** (Units in mm)

**PACKAGE OUTLINE S06**

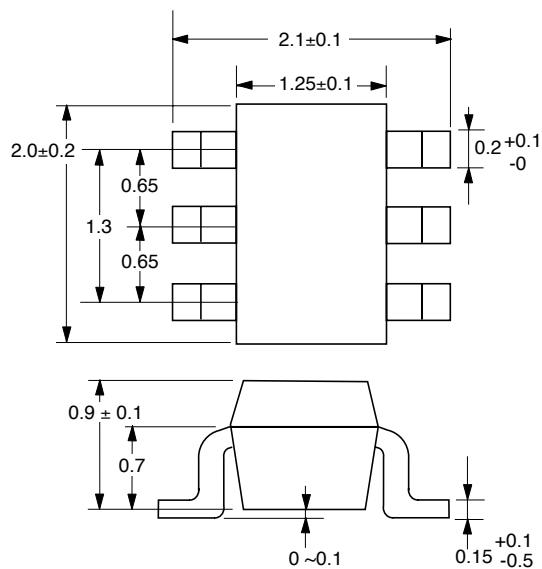

**LEAD CONNECTIONS**

(Top View)

(Bottom View)

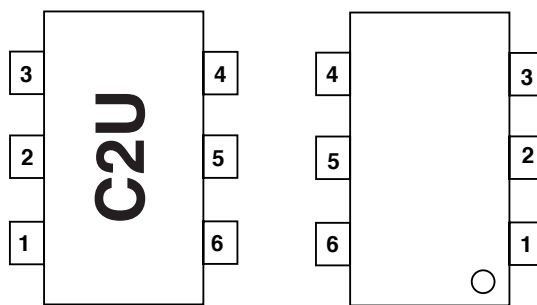

- 1. INPUT
- 2. GND
- 3. GND
- 4. OUTPUT
- 5. GND
- 6. Vcc

**ORDERING INFORMATION**

PART NUMBER	QUANTITY	MARKING
UPC8151TB-E3-A	3K/Reel	C2U

Note:  
Embossed tape, 8 mm wide. Pins 1, 2 and 3 face perforated side of tape.

**TEST CIRCUIT**

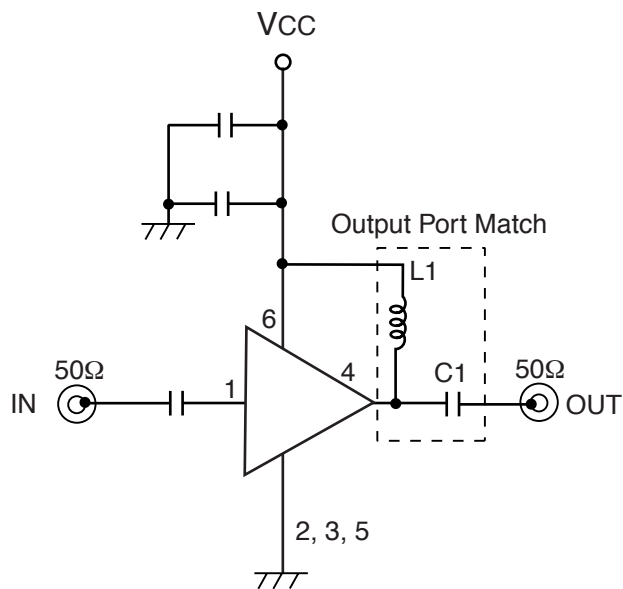

FOUR	L1	C1	All Other Caps = 1000 pF
900 MHz	12 nH	0.68 pF	
1900 MHz	2.7 nH	0.47 pF	

EXCLUSIVE NORTH AMERICAN AGENT FOR RF, MICROWAVE & OPTOELECTRONIC SEMICONDUCTORS

**CEL** CALIFORNIA EASTERN LABORATORIES • Headquarters • 4590 Patrick Henry Drive • Santa Clara, CA 95054-1817 • (408) 988-3500 • Telex 34-6393 • FAX (408) 988-0279  
24-Hour Fax-On-Demand: 800-390-3232 (U.S. and Canada only) • Internet: <http://WWW.CEL.COM>

DATA SUBJECT TO CHANGE WITHOUT NOTICE

9/29/2000

## Данный компонент на территории Российской Федерации

### Вы можете приобрести в компании MosChip.

Для оперативного оформления запроса Вам необходимо перейти по данной ссылке:

<http://moschip.ru/get-element>

Вы можете разместить у нас заказ для любого Вашего проекта, будь то серийное производство или разработка единичного прибора.

В нашем ассортименте представлены ведущие мировые производители активных и пассивных электронных компонентов.

Нашей специализацией является поставка электронной компонентной базы двойного назначения, продукции таких производителей как XILINX, Intel (ex.ALTERA), Vicor, Microchip, Texas Instruments, Analog Devices, Mini-Circuits, Amphenol, Glenair.

Сотрудничество с глобальными дистрибьюторами электронных компонентов, предоставляет возможность заказывать и получать с международных складов практически любой перечень компонентов в оптимальные для Вас сроки.

На всех этапах разработки и производства наши партнеры могут получить квалифицированную поддержку опытных инженеров.

Система менеджмента качества компании отвечает требованиям в соответствии с ГОСТ Р ИСО 9001, ГОСТ РВ 0015-002 и ЭС РД 009

### Офис по работе с юридическими лицами:

105318, г.Москва, ул.Щербаковская д.3, офис 1107, 1118, ДЦ «Щербаковский»

Телефон: +7 495 668-12-70 (многоканальный)

Факс: +7 495 668-12-70 (доб.304)

E-mail: [info@moschip.ru](mailto:info@moschip.ru)

Skype отдела продаж:

moschip.ru

moschip.ru\_4

moschip.ru\_6

moschip.ru\_9