

**Features**

- Advanced Process Technology
- Ultra Low On-Resistance
- 175°C Operating Temperature
- Fast Switching
- Repetitive Avalanche Allowed up to Tjmax
- Lead-Free, RoHS Compliant
- Automotive Qualified \*

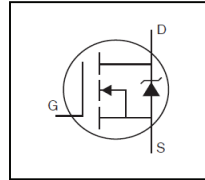

HEXFET® Power MOSFET

$V_{DSS}$		<b>60V</b>
$R_{DS(on)}$	typ.	<b>7.1mΩ</b>
	max.	<b>8.4mΩ</b>
$I_D$ (Silicon Limited)		<b>79A</b> Ⓛ
$I_D$ (Package Limited)		<b>56A</b>

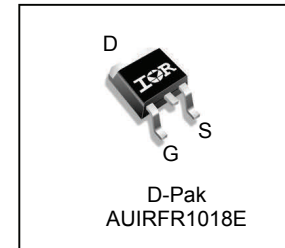

**Description**

Specifically designed for Automotive applications, this HEXFET® Power MOSFET utilizes the latest processing techniques to achieve extremely low on-resistance per silicon area. Additional features of this design are a 175°C junction operating temperature, fast switching speed and improved repetitive avalanche rating. These features combine to make this design an extremely efficient and reliable device for use in Automotive applications and a wide variety of other applications.

<b>G</b>	<b>D</b>	<b>S</b>
Gate	Drain	Source

Base part number	Package Type	Standard Pack		Orderable Part Number
		Form	Quantity	
AUIRFR1018E	D-Pak	Tube	75	AUIRFR1018E
		Tape and Reel Left	3000	AUIRFR1018ETRL

**Absolute Maximum Ratings**

Stresses beyond those listed under “Absolute Maximum Ratings” may cause permanent damage to the device. These are stress ratings only; and functional operation of the device at these or any other condition beyond those indicated in the specifications is not implied. Exposure to absolute-maximum-rated conditions for extended periods may affect device reliability. The thermal resistance and power dissipation ratings are measured under board mounted and still air conditions. Ambient temperature (TA) is 25°C, unless otherwise specified.

Symbol	Parameter	Max.	Units
$I_D @ T_C = 25^\circ C$	Continuous Drain Current, $V_{GS} @ 10V$ (Silicon Limited)	79Ⓛ	A
$I_D @ T_C = 100^\circ C$	Continuous Drain Current, $V_{GS} @ 10V$ (Silicon Limited)	56Ⓛ	
$I_D @ T_C = 25^\circ C$	Continuous Drain Current, $V_{GS} @ 10V$ (Package Limited)	56	
$I_{DM}$	Pulsed Drain Current ②	315	
$P_D @ T_C = 25^\circ C$	Maximum Power Dissipation	110	W
	Linear Derating Factor	0.76	W/°C
$V_{GS}$	Gate-to-Source Voltage	± 20	V
$E_{AS}$	Single Pulse Avalanche Energy (Thermally Limited) ③	88	mJ
$I_{AR}$	Avalanche Current ②	47	A
$E_{AR}$	Repetitive Avalanche Energy ②	11	mJ
$dv/dt$	Peak Diode Recovery $dv/dt$ ④	21	V/ns
$T_J$	Operating Junction and	-55 to + 175	°C
$T_{STG}$	Storage Temperature Range		
	Soldering Temperature, for 10 seconds (1.6mm from case)		

**Thermal Resistance**

Symbol	Parameter	Typ.	Max.	Units
$R_{\theta JC}$	Junction-to-Case ⑤	—	1.32	°C/W
$R_{\theta JA}$	Junction-to-Ambient ( PCB Mount) ⑤	—	50	
$R_{\theta JA}$	Junction-to-Ambient ⑤	—	110	

HEXFET® is a registered trademark of Infineon.

\*Qualification standards can be found at [www.infineon.com](http://www.infineon.com)

**Static @ T<sub>J</sub> = 25°C (unless otherwise specified)**

	Parameter	Min.	Typ.	Max.	Units	Conditions
V <sub>(BR)DSS</sub>	Drain-to-Source Breakdown Voltage	60	—	—	V	V <sub>GS</sub> = 0V, I <sub>D</sub> = 250μA
ΔV <sub>(BR)DSS</sub> /ΔT <sub>J</sub>	Breakdown Voltage Temp. Coefficient	—	0.073	—	V/°C	Reference to 25°C, I <sub>D</sub> = 5mA ②
R <sub>DS(on)</sub>	Static Drain-to-Source On-Resistance	—	7.1	8.4	mΩ	V <sub>GS</sub> = 10V, I <sub>D</sub> = 47A ⑤
V <sub>GS(th)</sub>	Gate Threshold Voltage	2.0	—	4.0	V	V <sub>DS</sub> = V <sub>GS</sub> , I <sub>D</sub> = 100μA
g <sub>fs</sub>	Forward Trans conductance	110	—	—	S	V <sub>DS</sub> = 50V, I <sub>D</sub> = 47A
R <sub>G(int)</sub>	Internal Gate Resistance	—	0.73	—	Ω	
I <sub>DSS</sub>	Drain-to-Source Leakage Current	—	—	20	μA	V <sub>DS</sub> = 60V, V <sub>GS</sub> = 0V
		—	—	250		V <sub>DS</sub> = 48V, V <sub>GS</sub> = 0V, T <sub>J</sub> = 125°C
I <sub>GSS</sub>	Gate-to-Source Forward Leakage	—	—	100	nA	V <sub>GS</sub> = 20V
	Gate-to-Source Reverse Leakage	—	—	-100		V <sub>GS</sub> = -20V

**Dynamic Electrical Characteristics @ T<sub>J</sub> = 25°C (unless otherwise specified)**

Q <sub>g</sub>	Total Gate Charge	—	46	69	nC	I <sub>D</sub> = 47A V <sub>DS</sub> = 30V V <sub>GS</sub> = 10V ⑤
Q <sub>gs</sub>	Gate-to-Source Charge	—	10	—		
Q <sub>gd</sub>	Gate-to-Drain Charge	—	12	—		
Q <sub>sync</sub>	Total Gate Charge Sync. (Q <sub>g</sub> - Q <sub>gd</sub> )	—	34	—	ns	V <sub>DD</sub> = 39V I <sub>D</sub> = 47A R <sub>G</sub> = 10Ω V <sub>GS</sub> = 10V ⑤
t <sub>d(on)</sub>	Turn-On Delay Time	—	13	—		
t <sub>r</sub>	Rise Time	—	35	—		
t <sub>d(off)</sub>	Turn-Off Delay Time	—	55	—		
t <sub>f</sub>	Fall Time	—	46	—	pF	V <sub>GS</sub> = 0V V <sub>DS</sub> = 50V f = 1.0MHz V <sub>GS</sub> = 0V, V <sub>DS</sub> = 0V to 48V ⑦ V <sub>GS</sub> = 0V, V <sub>DS</sub> = 0V to 48V ⑧
C <sub>iss</sub>	Input Capacitance	—	2290	—		
C <sub>oss</sub>	Output Capacitance	—	270	—		
C <sub>rss</sub>	Reverse Transfer Capacitance	—	130	—		
C <sub>oss eff. (ER)</sub>	Effective Output Capacitance (Energy Related)	—	390	—		
C <sub>oss eff. (TR)</sub>	Effective Output Capacitance (Time Related)	—	630	—		

**Diode Characteristics**

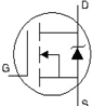
	Parameter	Min.	Typ.	Max.	Units	Conditions
I <sub>S</sub>	Continuous Source Current (Body Diode)	—	—	79 ①	A	MOSFET symbol showing the integral reverse p-n junction diode. 
I <sub>SM</sub>	Pulsed Source Current (Body Diode) ①	—	—	315		
V <sub>SD</sub>	Diode Forward Voltage	—	—	1.3	V	T <sub>J</sub> = 25°C, I <sub>S</sub> = 47A, V <sub>GS</sub> = 0V ⑤
t <sub>rr</sub>	Reverse Recovery Time	—	26	39	ns	T <sub>J</sub> = 25°C
		—	31	47		T <sub>J</sub> = 125°C V <sub>R</sub> = 51V,
Q <sub>rr</sub>	Reverse Recovery Charge	—	24	36	nC	T <sub>J</sub> = 25°C I <sub>F</sub> = 47A
		—	35	53		T <sub>J</sub> = 125°C di/dt = 100A/μs ⑤
		—	1.8	—	A	T <sub>J</sub> = 25°C
t <sub>on</sub>	Forward Turn-On Time	Intrinsic turn-on time is negligible (turn-on is dominated by L <sub>S</sub> +L <sub>D</sub> )				

**Notes:**

- ① Calculated continuous current based on maximum allowable junction temperature. Bond wire current limit is 56A. Note that current limitations arising from heating of the device leads may occur with some lead mounting arrangements.
- ② Repetitive rating; pulse width limited by max. junction temperature.
- ③ Limited by T<sub>Jmax</sub>, starting T<sub>J</sub> = 25°C, L = 0.08mH, R<sub>G</sub> = 25Ω, I<sub>AS</sub> = 47A, V<sub>GS</sub> = 10V. Part not recommended for use above this value.
- ④ I<sub>SD</sub> ≤ 47A, di/dt ≤ 1668A/μs, V<sub>DD</sub> ≤ V<sub>(BR)DSS</sub>, T<sub>J</sub> ≤ 175°C.
- ⑤ Pulse width ≤ 400μs; duty cycle ≤ 2%.
- ⑥ C<sub>oss eff. (TR)</sub> is a fixed capacitance that gives the same charging time as C<sub>oss</sub> while V<sub>DS</sub> is rising from 0 to 80% V<sub>DSS</sub>.
- ⑦ C<sub>oss eff. (ER)</sub> is a fixed capacitance that gives the same energy as C<sub>oss</sub> while V<sub>DS</sub> is rising from 0 to 80% V<sub>DSS</sub>.
- ⑧ When mounted on 1" square PCB (FR-4 or G-10 Material). For recommended footprint and soldering techniques refer to application note #AN-994
- ⑨ R<sub>θ</sub> is measured at T<sub>J</sub> approximately 90°C.

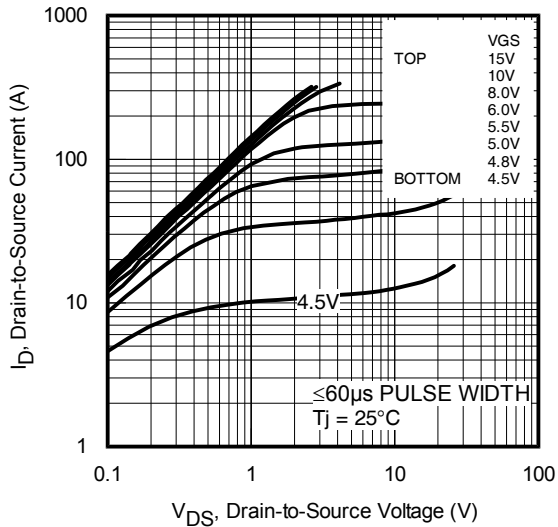
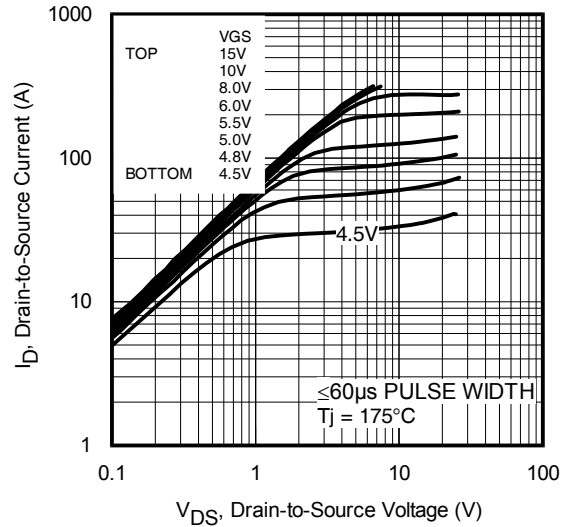
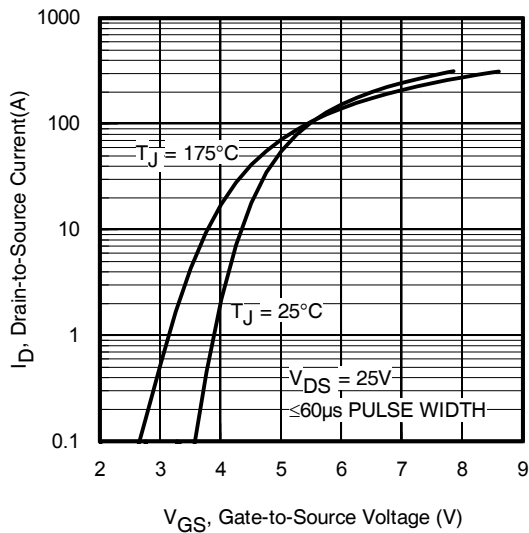
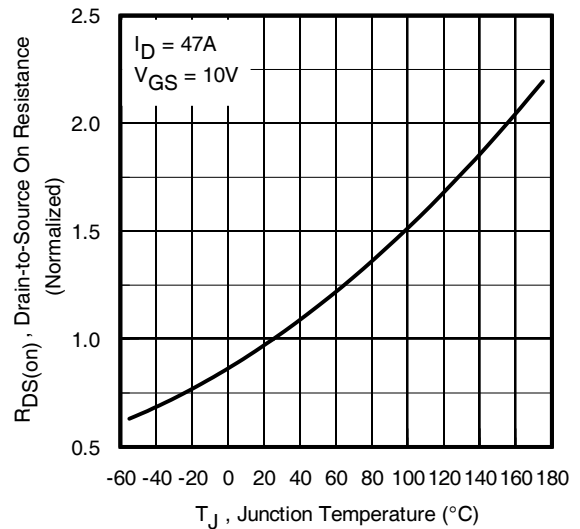
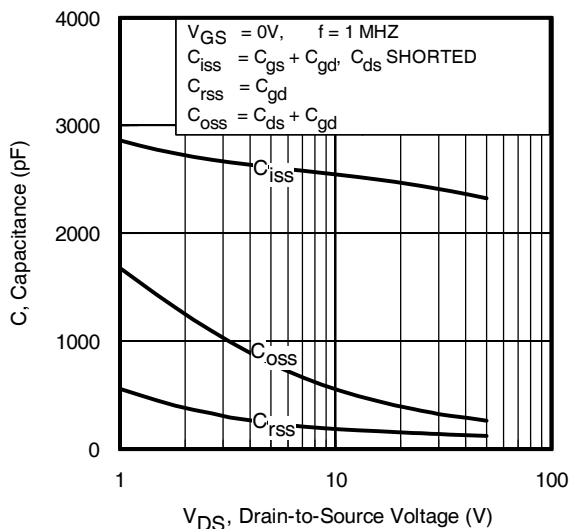
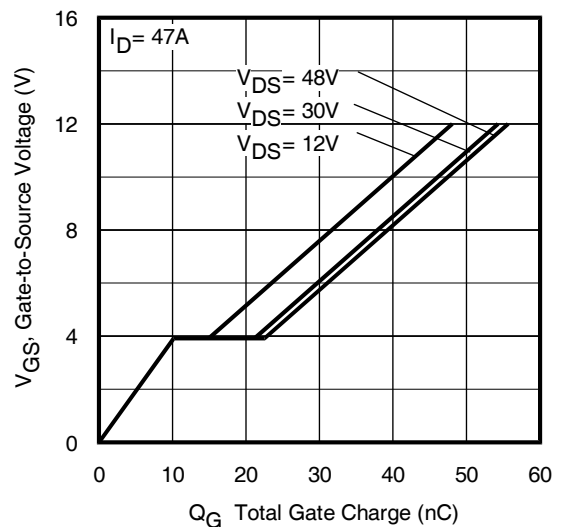
**Fig. 1** Typical Output Characteristics

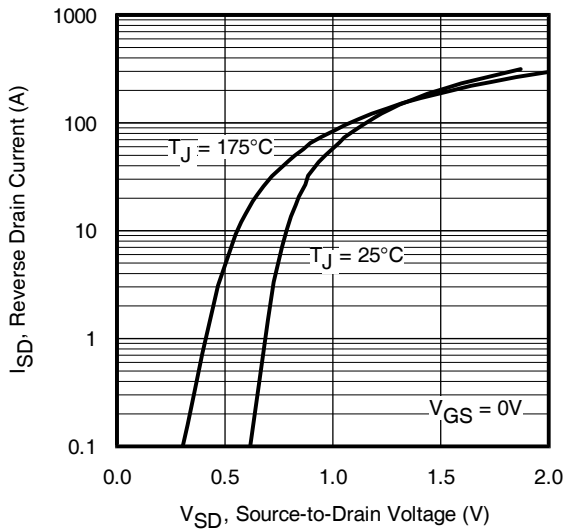
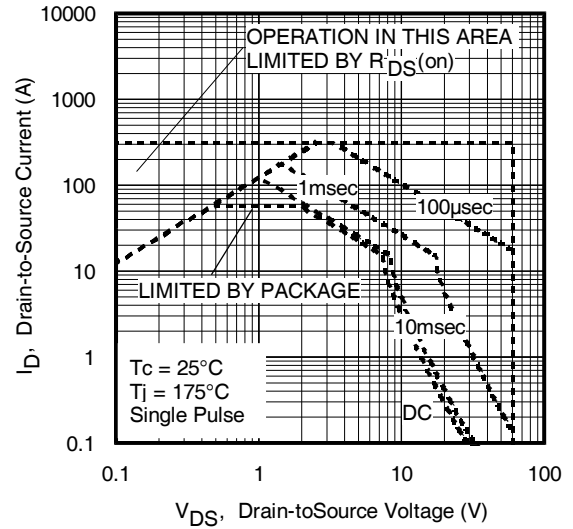
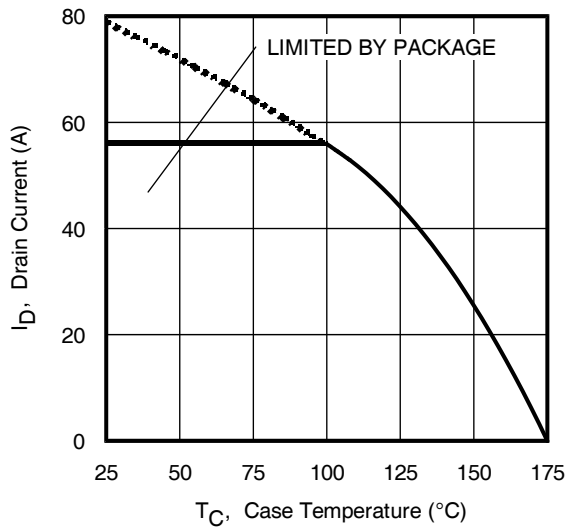
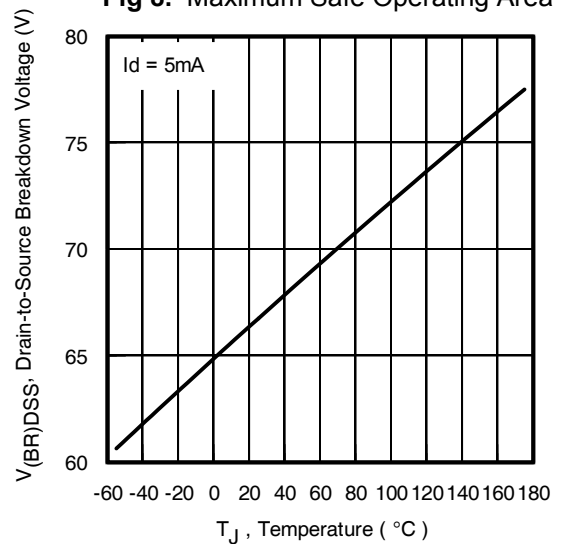
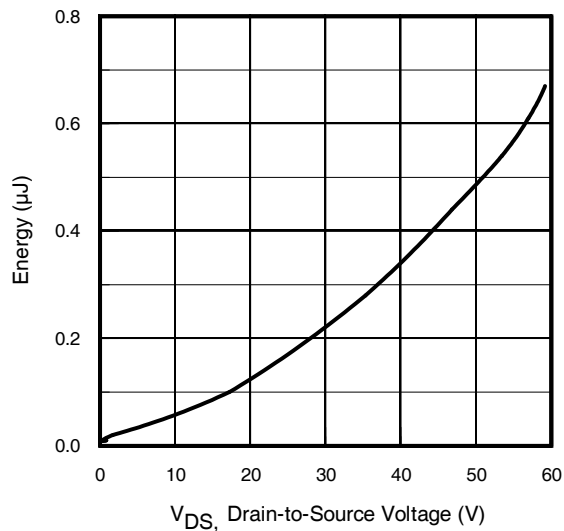
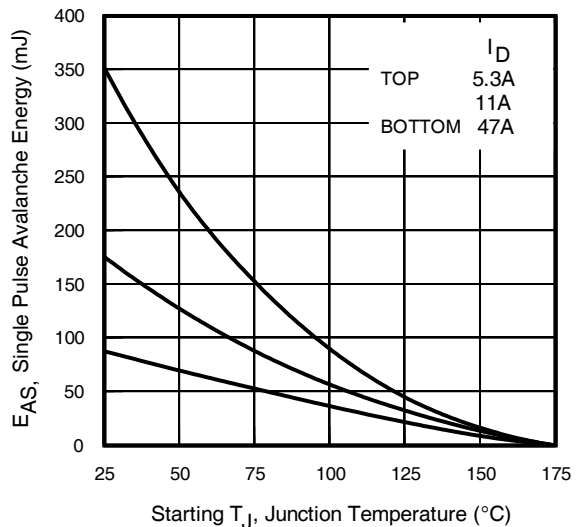
**Fig. 2** Typical Output Characteristics

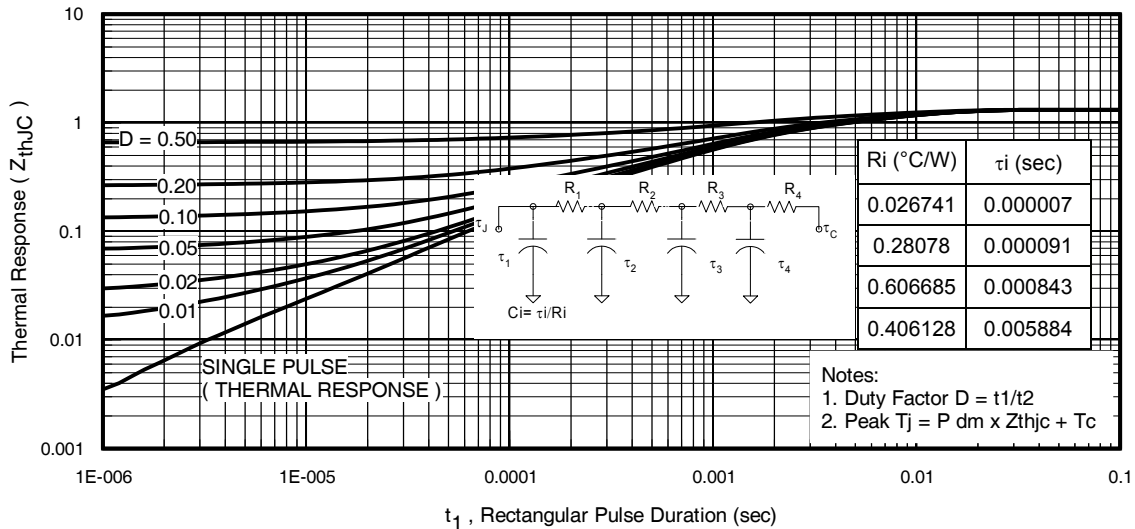
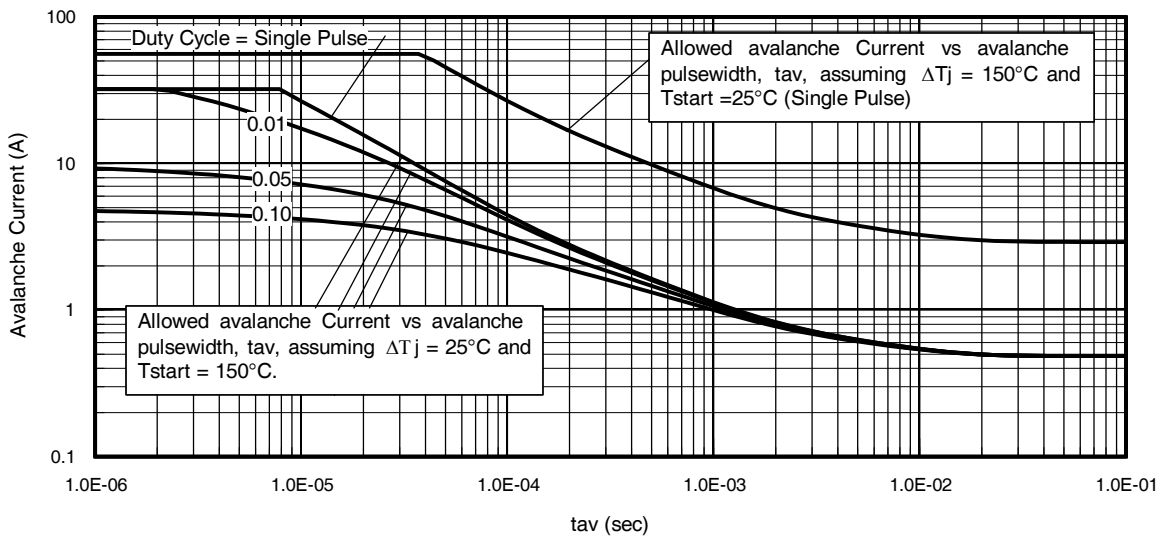
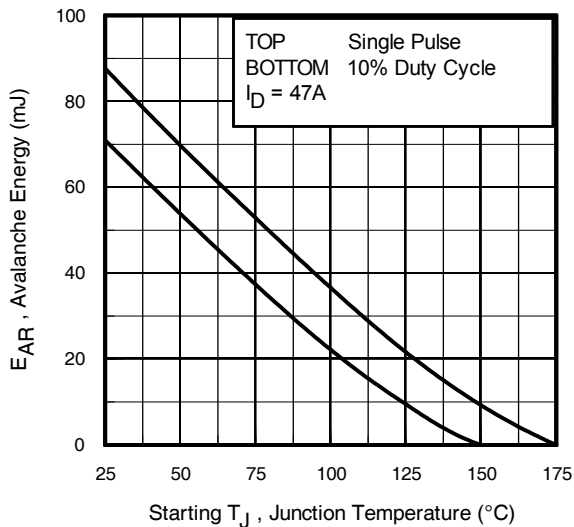
**Fig. 3** Typical Transfer Characteristics

**Fig. 4** Normalized On-Resistance vs. Temperature

**Fig 5.** Typical Capacitance vs. Drain-to-Source Voltage

**Fig 6.** Typical Gate Charge vs. Gate-to-Source Voltage

**Fig. 7** Typical Source-to-Drain Diode Forward Voltage

**Fig 8.** Maximum Safe Operating Area

**Fig. 9** Maximum Drain Current vs. Case Temperature

**Fig 10.** Drain-to-Source Breakdown Voltage

**Fig. 11** Typical Coss Stored Energy

**Fig 12.** Maximum Avalanche Energy vs. Drain Current

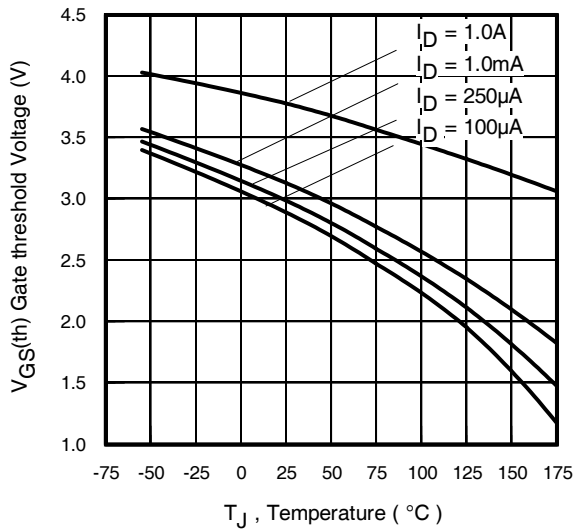
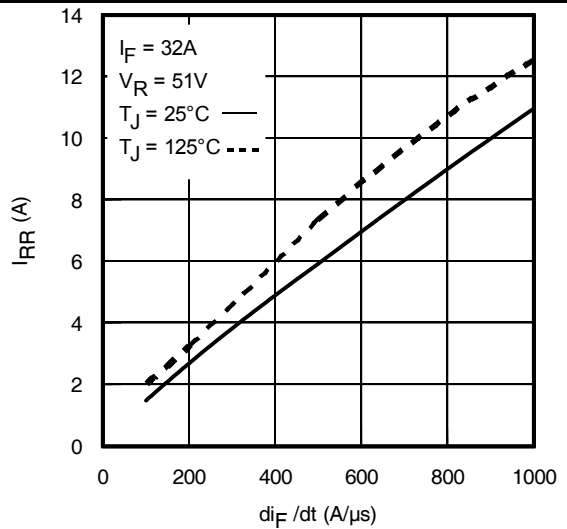
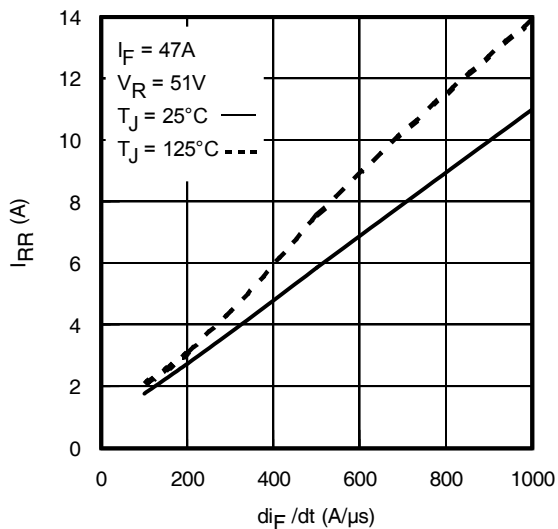
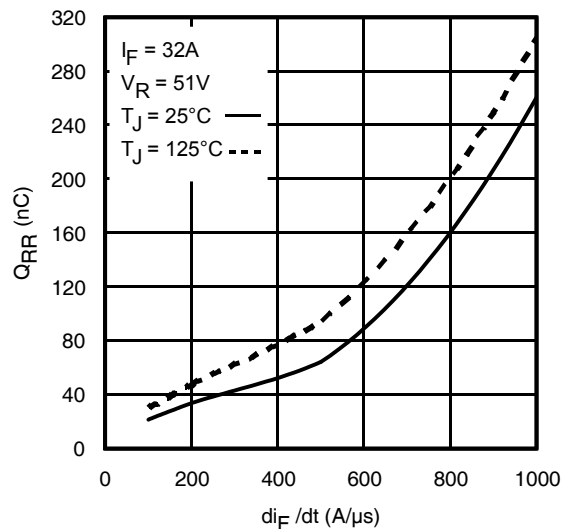
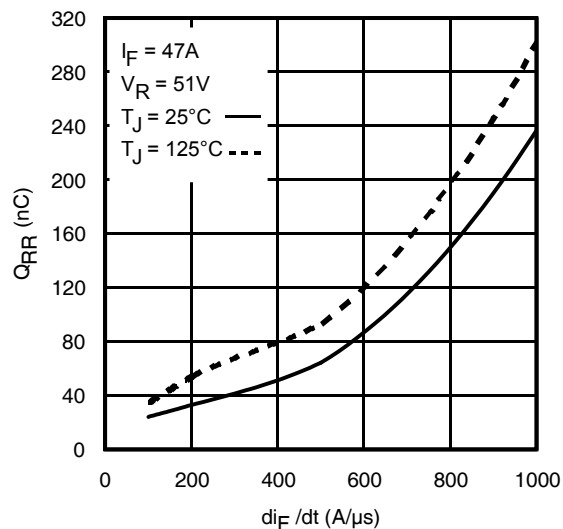

**Fig 13. Maximum Effective Transient Thermal Impedance, Junction-to-Case**

**Fig 14. Typical Avalanche Current Vs. Pulse width**

**Fig 15. Maximum Avalanche Energy Vs. Temperature**
**Notes on Repetitive Avalanche Curves , Figures 14, 15:  
 (For further info, see AN-1005 at www.infineon.com)**

1. Avalanche failures assumption:  
Purely a thermal phenomenon and failure occurs at a temperature far in excess of  $T_{jmax}$ . This is validated for every part type.
2. Safe operation in Avalanche is allowed as long as  $T_{jmax}$  is not exceeded.
3. Equation below based on circuit and waveforms shown in Figures 22a, 22b.
4.  $P_{D(ave)}$  = Average power dissipation per single avalanche pulse.
5.  $BV$  = Rated breakdown voltage (1.3 factor accounts for voltage increase during avalanche).
6.  $I_{av}$  = Allowable avalanche current.
7.  $\Delta T$  = Allowable rise in junction temperature, not to exceed  $T_{jmax}$  (assumed as 25°C in Figure 13, 14).  
 $t_{av}$  = Average time in avalanche.  
 $D$  = Duty cycle in avalanche =  $t_{av} \cdot f$   
 $Z_{thJC}(D, t_{av})$  = Transient thermal resistance, see Figures 13)

$$P_{D(ave)} = 1/2 ( 1.3 \cdot BV \cdot I_{av} ) = \Delta T / Z_{thJC}$$

$$I_{av} = 2\Delta T / [ 1.3 \cdot BV \cdot Z_{thJC} ]$$

$$E_{AS(AR)} = P_{D(ave)} \cdot t_{av}$$

**Fig 16. Threshold Voltage vs. Temperature**

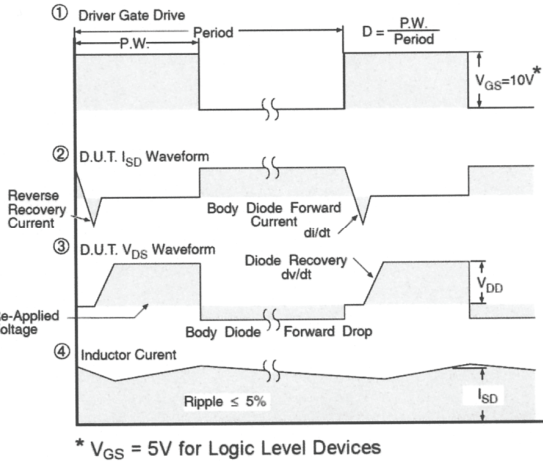
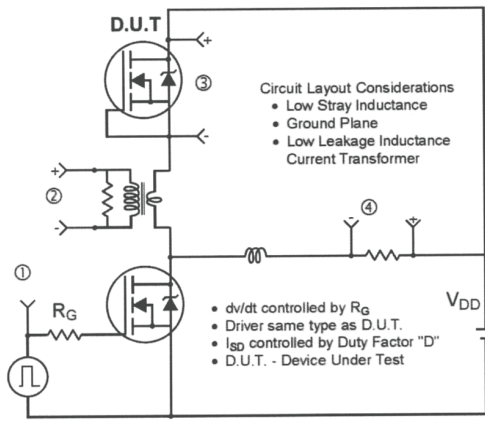
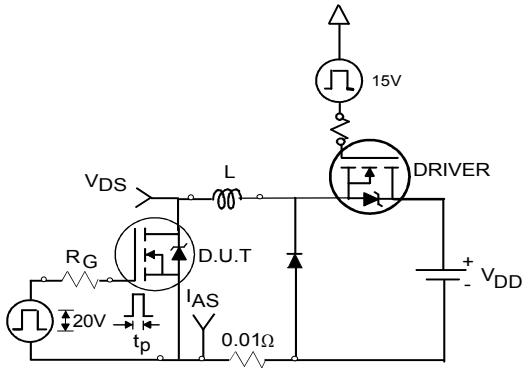
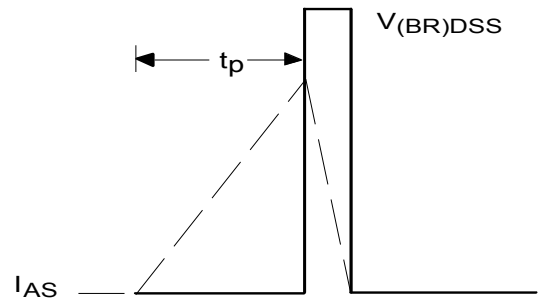
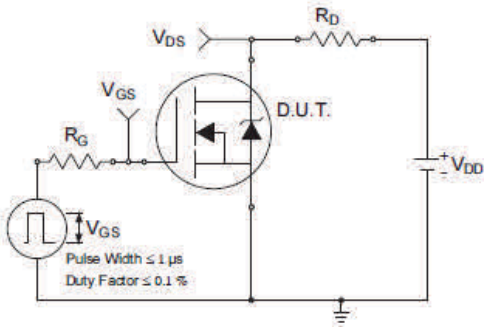
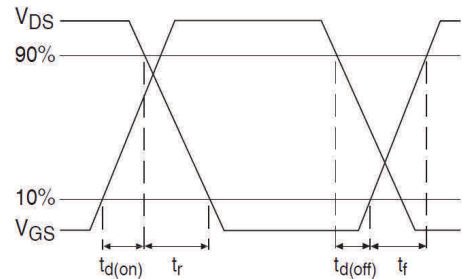
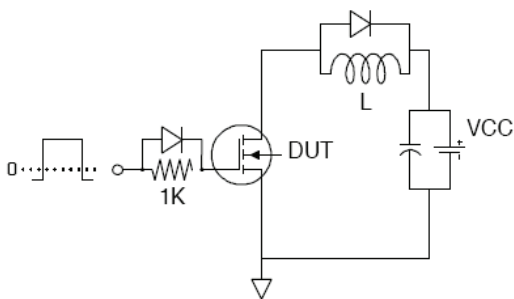
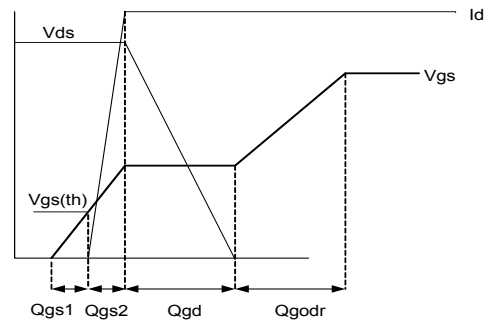
**Fig. 17 - Typical Recovery Current vs. di/dt**

**Fig. 18 - Typical Recovery Current vs. di/dt**

**Fig. 19 - Typical Stored Charge vs. di/dt**

**Fig. 20 - Typical Stored Charge vs. di/dt**

**Fig 20. Peak Diode Recovery dv/dt Test Circuit for N-Channel HEXFET® Power MOSFETs**

**Fig 21a. Unclamped Inductive Test Circuit**

**Fig 21b. Unclamped Inductive Waveforms**

**Fig 22a. Switching Time Test Circuit**

**Fig 22b. Switching Time Waveforms**

**Fig 23a. Gate Charge Test Circuit**

**Fig 23b. Gate Charge Waveform**

**D-Pak (TO-252AA) Package Outline (Dimensions are shown in millimeters (inches))**

**NOTES:**

- 1.- DIMENSIONING AND TOLERANCING PER ASME Y14.5M-1994
- 2.- DIMENSION ARE SHOWN IN INCHES [MILLIMETERS]
- △ LEAD DIMENSION UNCONTROLLED IN L5.
- △ DIMENSION D1, E1, L3 & b3 ESTABLISH A MINIMUM MOUNTING SURFACE FOR THERMAL PAD.
- 5.- SECTION C-C DIMENSIONS APPLY TO THE FLAT SECTION OF THE LEAD BETWEEN .005 AND 0.10 [0.13 AND 0.25] FROM THE LEAD TIP.
- △ DIMENSION D & E DO NOT INCLUDE MOLD FLASH. MOLD FLASH SHALL NOT EXCEED .005 [0.13] PER SIDE. THESE DIMENSIONS ARE MEASURED AT THE OUTMOST EXTREMES OF THE PLASTIC BODY.
- △ DIMENSION b1 & c1 APPLIED TO BASE METAL ONLY.
- △ DATUM A & B TO BE DETERMINED AT DATUM PLANE H.
- 9.- OUTLINE CONFORMS TO JEDEC OUTLINE TO-252AA.

SYMBOL	DIMENSIONS				NOTES
	MILLIMETERS		INCHES		
	MIN.	MAX.	MIN.	MAX.	
A	2.18	2.39	.086	.094	
A1	-	0.13	-	.005	
b	0.64	0.89	.025	.035	
b1	0.65	0.79	.025	.031	7
b2	0.76	1.14	.030	.045	
b3	4.95	5.46	.195	.215	4
c	0.46	0.61	.018	.024	
c1	0.41	0.56	.016	.022	7
c2	0.46	0.89	.018	.035	
D	5.97	6.22	.235	.245	6
D1	5.21	-	.205	-	4
E	6.35	6.73	.250	.265	6
E1	4.32	-	.170	-	4
e	2.29 BSC		.090 BSC		
H	9.40	10.41	.370	.410	
L	1.40	1.78	.055	.070	
L1	2.74 BSC		.108 REF.		
L2	0.51 BSC		.020 BSC		
L3	0.89	1.27	.035	.050	4
L4	-	1.02	-	.040	
L5	1.14	1.52	.045	.060	3
φ	0"	10"	0"	10"	
φ1	0"	15"	0"	15"	
φ2	25"	35"	25"	35"	

LEAD ASSIGNMENTS
HEXFET

- 1.- GATE
- 2.- DRAIN
- 3.- SOURCE
- 4.- DRAIN

IGBT & CoPAK

- 1.- GATE
- 2.- COLLECTOR
- 3.- EMITTER
- 4.- COLLECTOR

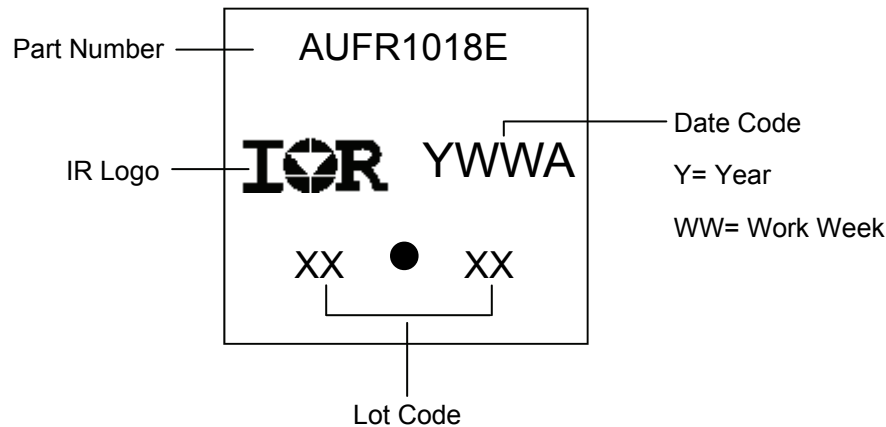
**D-Pak (TO-252AA) Part Marking Information**

Note: For the most current drawing please refer to IR website at <http://www.irf.com/package/>



**D-Pak (TO-252AA) Tape & Reel Information (Dimensions are shown in millimeters (inches))**

**NOTES :**

1. CONTROLLING DIMENSION : MILLIMETER.
2. ALL DIMENSIONS ARE SHOWN IN MILLIMETERS ( INCHES ).
3. OUTLINE CONFORMS TO EIA-481 & EIA-541.

**NOTES :**

1. OUTLINE CONFORMS TO EIA-481.

Note: For the most current drawing please refer to IR website at <http://www.irf.com/package/>

**Qualification Information**

<b>Qualification Level</b>		Automotive (per AEC-Q101)	
		Comments: This part number(s) passed Automotive qualification. Infineon's Industrial and Consumer qualification level is granted by extension of the higher Automotive level.	
<b>Moisture Sensitivity Level</b>		D-Pak	MSL1
<b>ESD</b>	Machine Model	Class M4 (+/- 600V) <sup>†</sup> AEC-Q101-002	
	Human Body Model	Class H1C (+/- 1500V) <sup>†</sup> AEC-Q101-001	
	Charged Device Model	Class C4 (+/- 1000V) <sup>†</sup> AEC-Q101-005	
<b>RoHS Compliant</b>		Yes	

† Highest passing voltage.

**Revision History**

Date	Comments
11/19/2015	<ul style="list-style-type: none"> <li>Updated datasheet with corporate template</li> <li>Corrected ordering table on page 1.</li> <li>Corrected typo on test condition Coss eff. <math>V_{DS}</math> from "60V" to "48V" on page 2.</li> <li>Updated typo on the fig.19 and fig.20, unit of y-axis from "A" to "nC" on page 6.</li> </ul>

**Published by**  
**Infineon Technologies AG**  
**81726 München, Germany**  
 © Infineon Technologies AG 2015  
**All Rights Reserved.**

**IMPORTANT NOTICE**

The information given in this document shall in no event be regarded as a guarantee of conditions or characteristics ("Beschaffenheitsgarantie"). With respect to any examples, hints or any typical values stated herein and/or any information regarding the application of the product, Infineon Technologies hereby disclaims any and all warranties and liabilities of any kind, including without limitation warranties of non-infringement of intellectual property rights of any third party.

In addition, any information given in this document is subject to customer's compliance with its obligations stated in this document and any applicable legal requirements, norms and standards concerning customer's products and any use of the product of Infineon Technologies in customer's applications.

The data contained in this document is exclusively intended for technically trained staff. It is the responsibility of customer's technical departments to evaluate the suitability of the product for the intended application and the completeness of the product information given in this document with respect to such application.

For further information on the product, technology, delivery terms and conditions and prices please contact your nearest Infineon Technologies office ([www.infineon.com](http://www.infineon.com)).

**WARNINGS**

Due to technical requirements products may contain dangerous substances. For information on the types in question please contact your nearest Infineon Technologies office.

Except as otherwise explicitly approved by Infineon Technologies in a written document signed by authorized representatives of Infineon Technologies, Infineon Technologies' products may not be used in any applications where a failure of the product or any consequences of the use thereof can reasonably be expected to result in personal injury.

## Данный компонент на территории Российской Федерации

### Вы можете приобрести в компании MosChip.

Для оперативного оформления запроса Вам необходимо перейти по данной ссылке:

<http://moschip.ru/get-element>

Вы можете разместить у нас заказ для любого Вашего проекта, будь то серийное производство или разработка единичного прибора.

В нашем ассортименте представлены ведущие мировые производители активных и пассивных электронных компонентов.

Нашей специализацией является поставка электронной компонентной базы двойного назначения, продукции таких производителей как XILINX, Intel (ex.ALTERA), Vicor, Microchip, Texas Instruments, Analog Devices, Mini-Circuits, Amphenol, Glenair.

Сотрудничество с глобальными дистрибьюторами электронных компонентов, предоставляет возможность заказывать и получать с международных складов практически любой перечень компонентов в оптимальные для Вас сроки.

На всех этапах разработки и производства наши партнеры могут получить квалифицированную поддержку опытных инженеров.

Система менеджмента качества компании отвечает требованиям в соответствии с ГОСТ Р ИСО 9001, ГОСТ РВ 0015-002 и ЭС РД 009

### Офис по работе с юридическими лицами:

105318, г.Москва, ул.Щербаковская д.3, офис 1107, 1118, ДЦ «Щербаковский»

Телефон: +7 495 668-12-70 (многоканальный)

Факс: +7 495 668-12-70 (доб.304)

E-mail: [info@moschip.ru](mailto:info@moschip.ru)

Skype отдела продаж:

moschip.ru

moschip.ru\_4

moschip.ru\_6

moschip.ru\_9