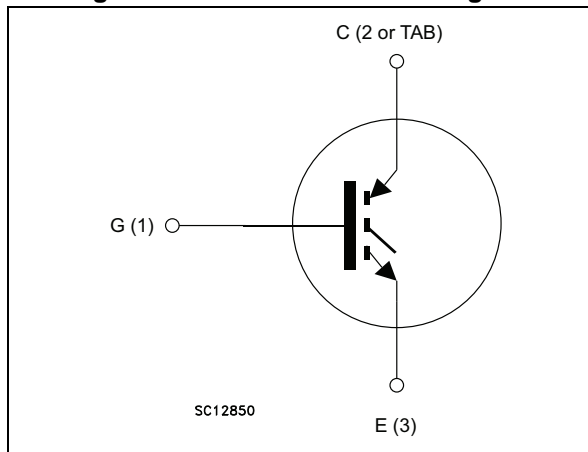

Figure 1. Internal schematic diagram



Features

- Maximum junction temperature: $T_J = 175\text{ °C}$
- High speed switching series
- Minimized tail current
- $V_{CE(sat)} = 1.6\text{ V (typ.) @ } I_C = 80\text{ A}$
- Tight parameter distribution
- Safe paralleling
- Low thermal resistance

Applications

- Photovoltaic inverters
- High frequency converters

Description

This device is an IGBT developed using an advanced proprietary trench gate and field stop structure. The device is part of the new “HB” series of IGBTs, which represent an optimum compromise between conduction and switching losses to maximize the efficiency of any frequency converter. Furthermore, a slightly positive $V_{CE(sat)}$ temperature coefficient and very tight parameter distribution result in safer paralleling operation.

Table 1. Device summary

Order code	Marking	Package	Packaging
STGW80H65FB	GW80H65FB	TO-247	Tube
STGWA80H65FB	GWA80H65FB	TO-247 long leads	Tube
STGWT80H65FB	GWT80H65FB	TO-3P	Tube

Contents

- 1 Electrical ratings 3**
- 2 Electrical characteristics 4**
 - 2.1 Electrical characteristics (curves) 6
- 3 Test circuits 10**
- 4 Package mechanical data 11**
 - 4.1 TO-247, STGW80H65FB11
 - 4.2 TO-247 long leads, STGWA80H65FB 13
 - 4.3 TO-3P, STGWT80H65FB 15
- 5 Revision history 17**

1 Electrical ratings

Table 2. Absolute maximum ratings

Symbol	Parameter	Value	Unit
V_{CES}	Collector-emitter voltage ($V_{GE} = 0$)	650	V
I_C	Continuous collector current at $T_C = 25\text{ °C}$	120 ⁽¹⁾	A
I_C	Continuous collector current at $T_C = 100\text{ °C}$	80	A
I_{CP} ⁽²⁾	Pulsed collector current	240	A
V_{GE}	Gate-emitter voltage	± 20	V
P_{TOT}	Total dissipation at $T_C = 25\text{ °C}$	469	W
T_{STG}	Storage temperature range	- 55 to 150	°C
T_J	Operating junction temperature	- 55 to 175	°C

1. Current level is limited by bond wires.
2. Pulse width limited by maximum junction temperature.

Table 3. Thermal data

Symbol	Parameter	Value	Unit
R_{thJC}	Thermal resistance junction-case	0.32	°C/W
R_{thJA}	Thermal resistance junction-ambient	50	°C/W

2 Electrical characteristics

$T_J = 25\text{ °C}$ unless otherwise specified.

Table 4. Static characteristics

Symbol	Parameter	Test conditions	Min.	Typ.	Max.	Unit
$V_{(BR)CES}$	Collector-emitter breakdown voltage ($V_{GE} = 0$)	$I_C = 2\text{ mA}$	650			V
$V_{CE(sat)}$	Collector-emitter saturation voltage	$V_{GE} = 15\text{ V}, I_C = 80\text{ A}$		1.6	2	V
		$V_{GE} = 15\text{ V}, I_C = 80\text{ A}$ $T_J = 125\text{ °C}$		1.8		
		$V_{GE} = 15\text{ V}, I_C = 80\text{ A}$ $T_J = 175\text{ °C}$		1.9		
$V_{GE(th)}$	Gate threshold voltage	$V_{CE} = V_{GE}, I_C = 1\text{ mA}$	5	6	7	V
I_{CES}	Collector cut-off current ($V_{GE} = 0$)	$V_{CE} = 650\text{ V}$			100	μA
I_{GES}	Gate-emitter leakage current ($V_{CE} = 0$)	$V_{GE} = \pm 20\text{ V}$			250	nA

Table 5. Dynamic characteristics

Symbol	Parameter	Test conditions	Min.	Typ.	Max.	Unit
C_{ies}	Input capacitance	$V_{CE} = 25\text{ V}, f = 1\text{ MHz},$ $V_{GE} = 0$	-	10524	-	pF
C_{oes}	Output capacitance		-	385	-	pF
C_{res}	Reverse transfer capacitance		-	215	-	pF
Q_g	Total gate charge	$V_{CC} = 520\text{ V}, I_C = 80\text{ A},$ $V_{GE} = 15\text{ V},$ see Figure 23	-	414	-	nC
Q_{ge}	Gate-emitter charge		-	78	-	nC
Q_{gc}	Gate-collector charge		-	170	-	nC

Table 6. IGBT switching characteristics (inductive load)

Symbol	Parameter	Test conditions	Min.	Typ.	Max.	Unit
$t_{d(on)}$	Turn-on delay time	$V_{CE} = 400\text{ V}$, $I_C = 80\text{ A}$, $R_G = 10\ \Omega$, $V_{GE} = 15\text{ V}$, see Figure 22	-	84	-	ns
t_r	Current rise time		-	52	-	ns
$(di/dt)_{on}$	Turn-on current slope		-	1270	-	A/ μs
$t_{d(off)}$	Turn-off delay time		-	280	-	ns
t_f	Current fall time		-	31	-	ns
$E_{on}^{(1)}$	Turn-on switching losses		-	2.1	-	mJ
$E_{off}^{(2)}$	Turn-off switching losses		-	1.5	-	mJ
E_{ts}	Total switching losses	-	3.6	-	mJ	
$t_{d(on)}$	Turn-on delay time	$V_{CE} = 400\text{ V}$, $I_C = 80\text{ A}$, $R_G = 10\ \Omega$, $V_{GE} = 15\text{ V}$, $T_J = 175\text{ }^\circ\text{C}$, see Figure 22	-	77	-	ns
t_r	Current rise time		-	51	-	ns
$(di/dt)_{on}$	Turn-on current slope		-	1270	-	A/ μs
$t_{d(off)}$	Turn-off delay time		-	328	-	ns
t_f	Current fall time		-	30	-	ns
$E_{on}^{(1)}$	Turn-on switching losses		-	4.4	-	mJ
$E_{off}^{(2)}$	Turn-off switching losses		-	2.1	-	mJ
E_{ts}	Total switching losses	-	6.5	-	mJ	

1. Energy losses include reverse recovery of the external diode. The diode is the same of the co-packed STGW80H65DFB
2. Turn-off losses include also the tail of the collector current.

2.1 Electrical characteristics (curves)

Figure 2. Output characteristics ($T_J = 25^\circ\text{C}$)

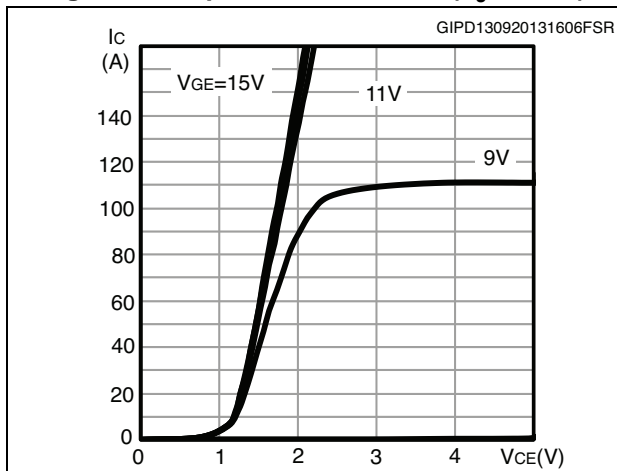

Figure 3. Output characteristics ($T_J = 175^\circ\text{C}$)

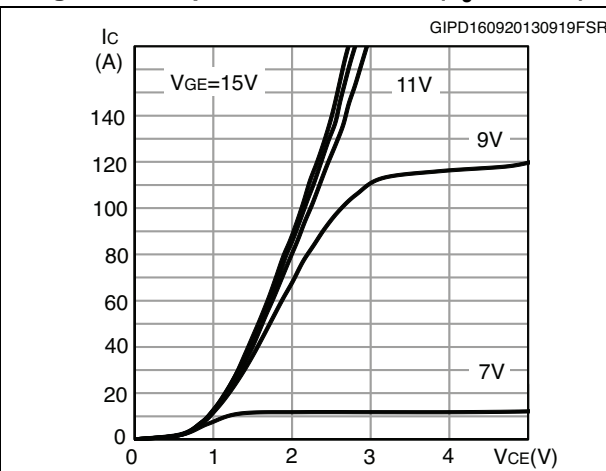

Figure 4. Transfer characteristics

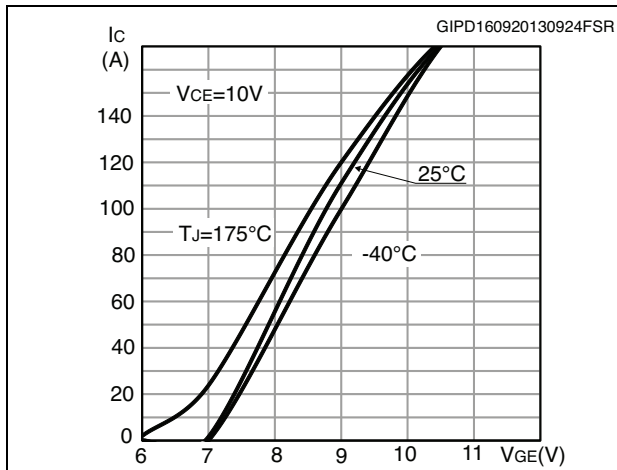

Figure 5. Collector current vs. case temperature

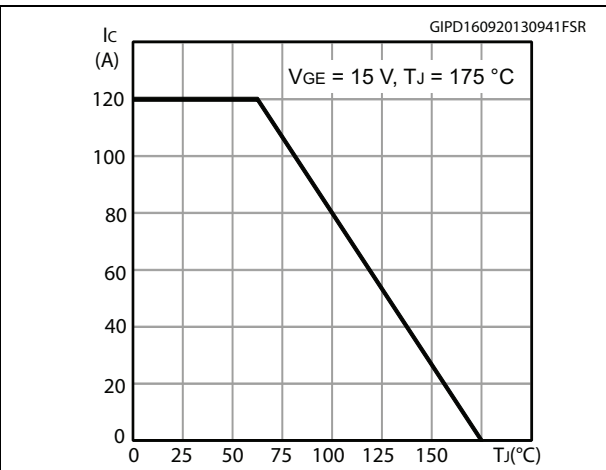

Figure 6. Power dissipation vs. case temperature

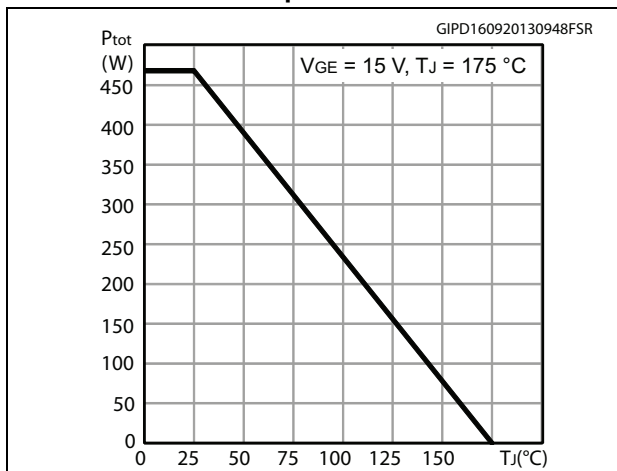

Figure 7. $V_{CE(sat)}$ vs. junction temperature

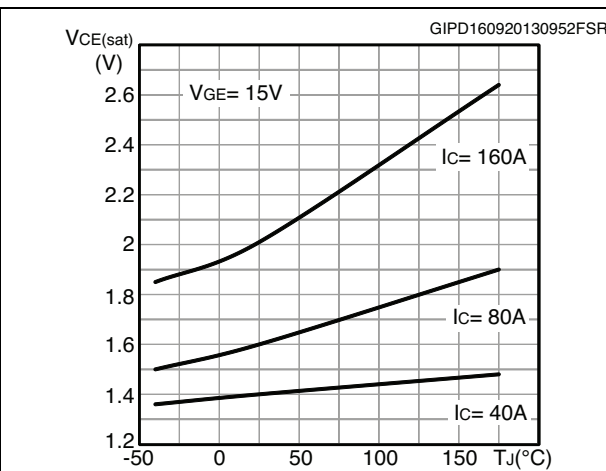

Figure 8. $V_{CE(sat)}$ vs. collector current

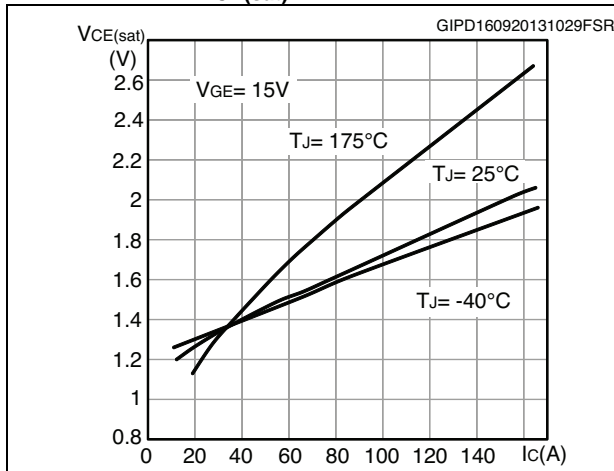

Figure 9. Forward bias safe operating area

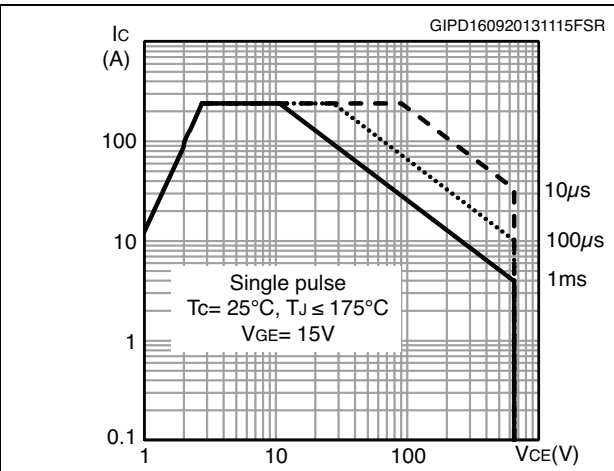

Figure 10. Capacitance variations

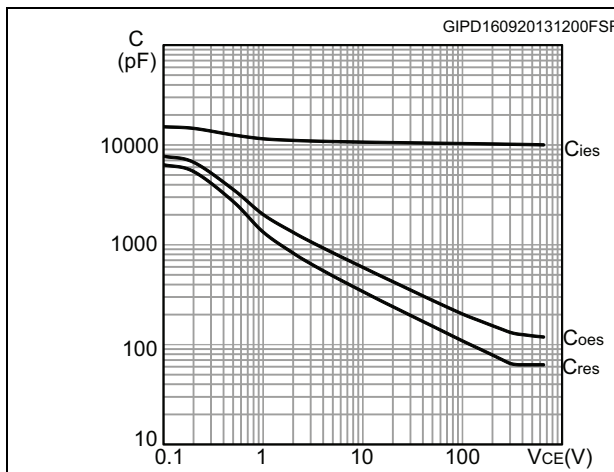

Figure 11. Normalized $V_{(BR)CES}$ vs. junction temperature

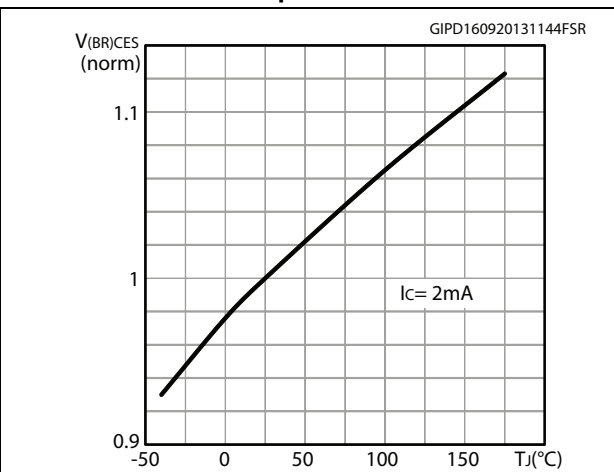

Figure 12. Normalized $V_{GE(th)}$ vs. junction temperature

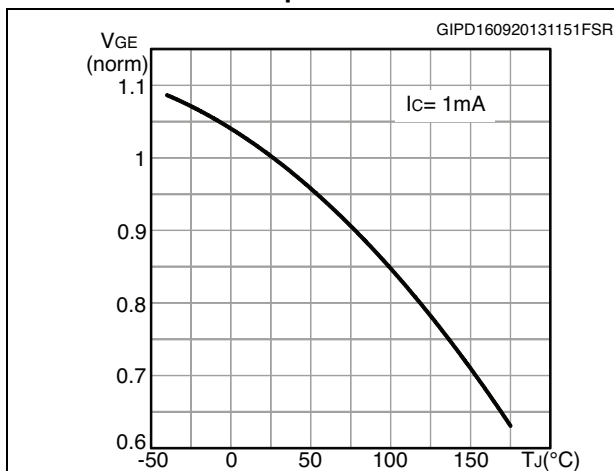

Figure 13. Gate charge vs. gate-emitter voltage

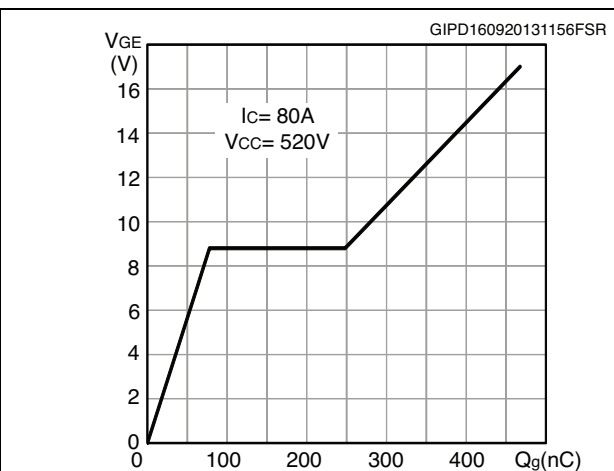

Figure 14. Switching loss vs temperature

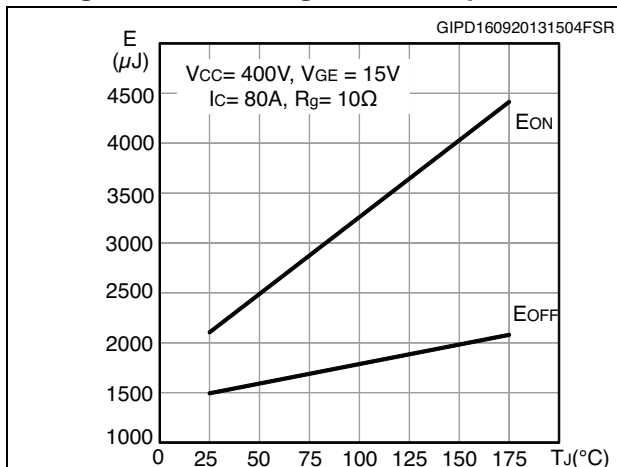

Figure 15. Switching loss vs gate resistance

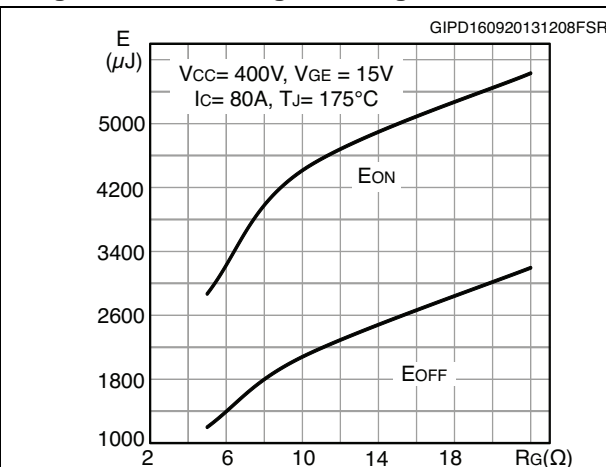

Figure 16. Switching loss vs collector current

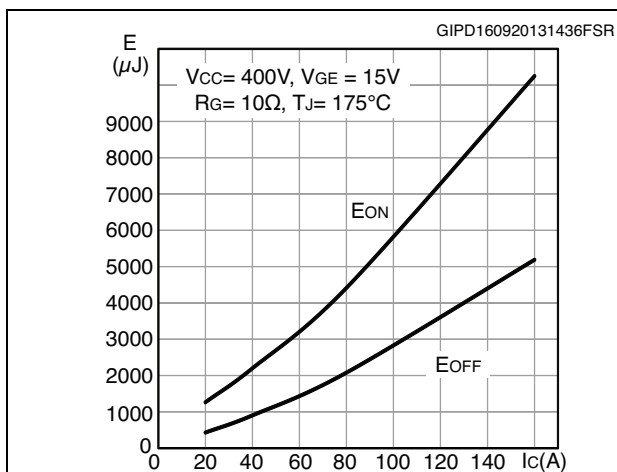

Figure 17. Switching loss vs collector emitter voltage

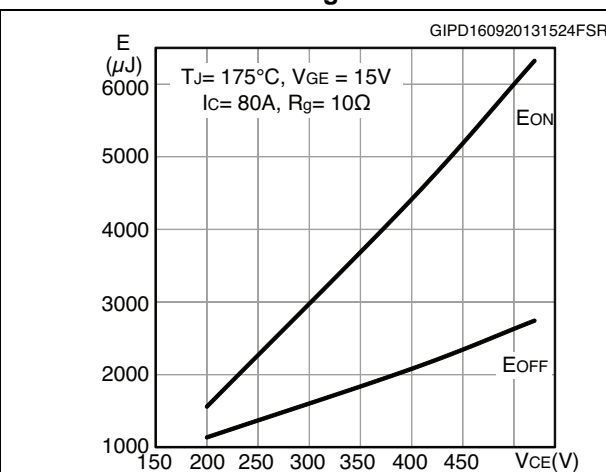

Figure 18. Switching times vs. collector current

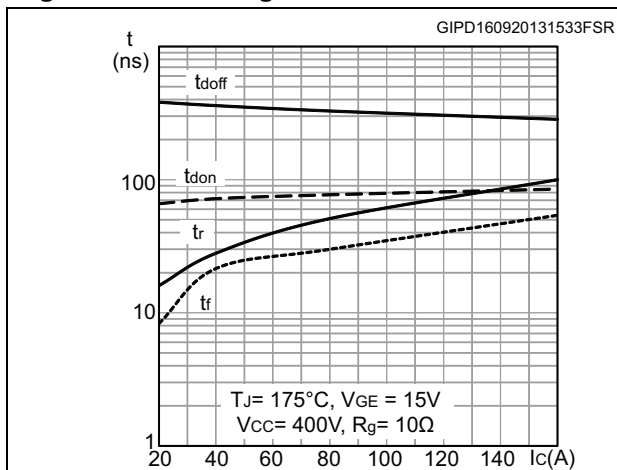

Figure 19. Switching times vs. gate resistance

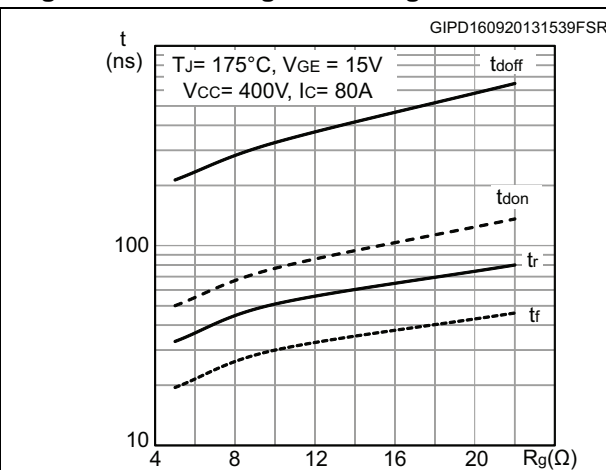
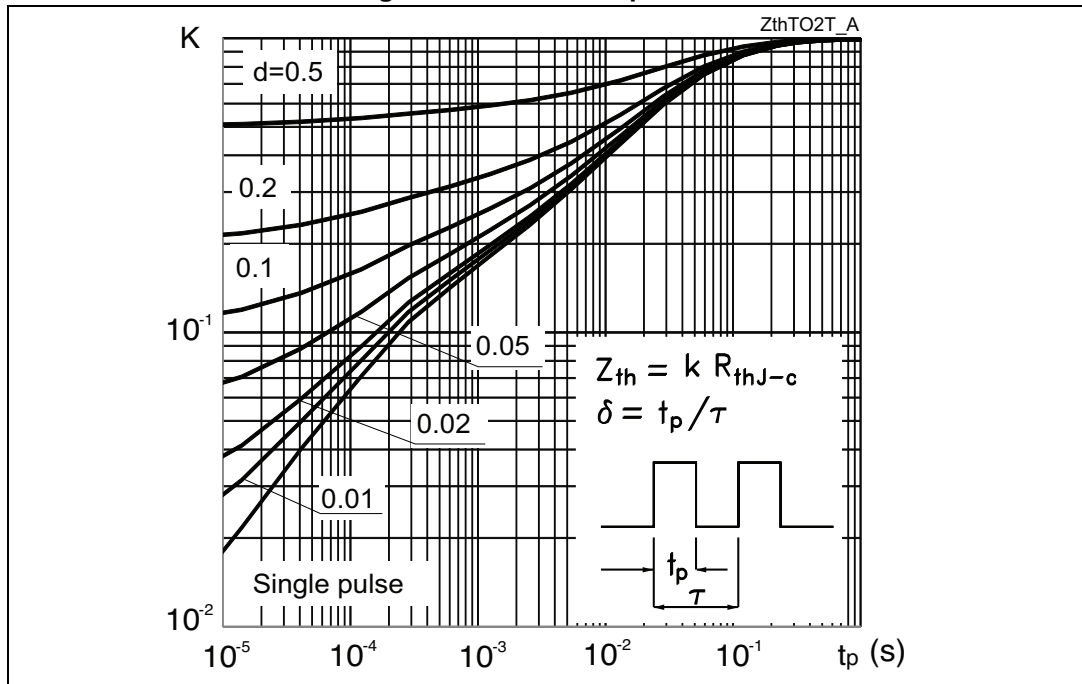

Figure 20. Collector current vs. switching frequency



Figure 21. Thermal impedance



3 Test circuits

Figure 22. Test circuit for inductive load switching

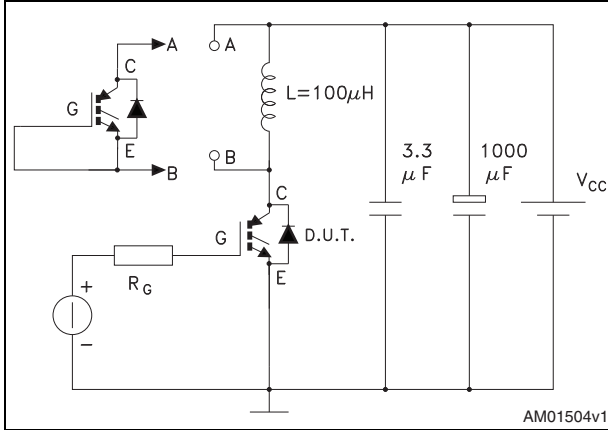

Figure 23. Gate charge test circuit

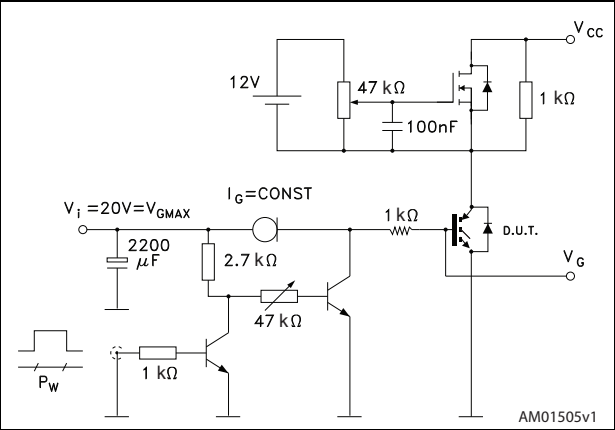
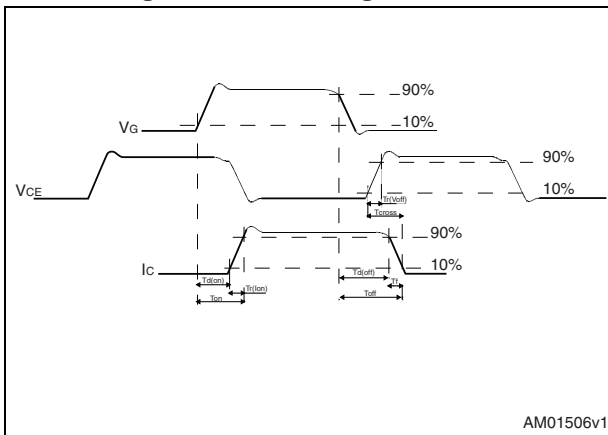

Figure 24. Switching waveform



4 Package mechanical data

In order to meet environmental requirements, ST offers these devices in different grades of ECOPACK® packages, depending on their level of environmental compliance. ECOPACK® specifications, grade definitions and product status are available at: www.st.com. ECOPACK is an ST trademark.

4.1 TO-247, STGW80H65FB

Figure 25. TO-247 drawing

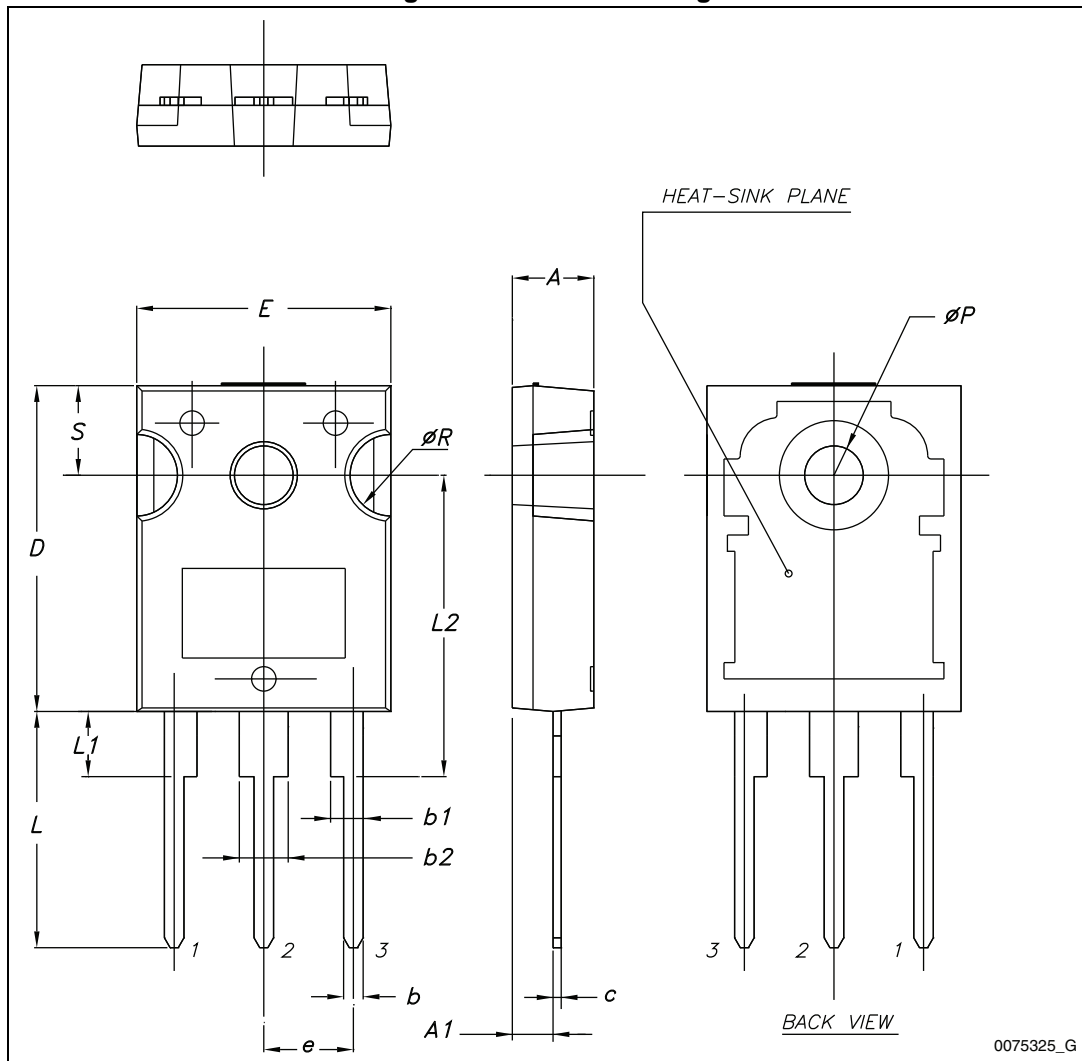

Table 7. TO-247 mechanical data

Dim.	mm.		
	Min.	Typ.	Max.
A	4.85		5.15
A1	2.20		2.60
b	1.0		1.40
b1	2.0		2.40
b2	3.0		3.40
c	0.40		0.80
D	19.85		20.15
E	15.45		15.75
e	5.30	5.45	5.60
L	14.20		14.80
L1	3.70		4.30
L2		18.50	
ØP	3.55		3.65
ØR	4.50		5.50
S	5.30	5.50	5.70

4.2 TO-247 long leads, STGWA80H65FB

Figure 26. TO-247 long leads drawing



8463846_A_F

Table 8. TO-247 long leads mechanical data

Dim.	mm		
	Min.	Typ.	Max.
A	4.90	5.00	5.10
A1	2.31	2.41	2.51
A2	1.90	2.00	2.10
b	1.16		1.26
b2			3.25
b3			2.25
c	0.59		0.66
D	20.90	21.00	21.10
E	15.70	15.80	15.90
E2	4.90	5.00	5.10
E3	2.40	2.50	2.60
e	5.34	5.44	5.54
L	19.80	19.92	20.10
L1			4.30
P	3.50	3.60	3.70
Q	5.60		6.00
S	6.05	6.15	6.25

4.3 TO-3P, STGWT80H65FB

Figure 27. TO-3P drawing



Table 9. TO-3P mechanical data

Dim.	mm		
	Min.	Typ.	Max.
A	4.60	4.80	5
A1	1.45	1.50	1.65
A2	1.20	1.40	1.60
b	0.80	1.00	1.20
b1	1.80	2.00	2.20
b2	2.80	3.00	3.20
c	0.55	0.60	0.75
D	19.70	19.90	20.10
D1	13.70	13.90	14.10
E	15.40	15.60	15.80
E1	13.40	13.60	13.80
E2	9.40	9.60	9.90
e	5.15	5.45	5.75
L	19.80	20	20.20
L1	3.30	3.50	3.70
L2	18.20	18.40	18.60
øP	3.30	3.40	3.50
øP1	3.10	3.20	3.30
Q	4.80	5	5.20
Q1	3.60	3.80	4

5 Revision history

Table 10. Document revision history

Date	Revision	Changes
13-Jun-2014	1	Initial release.

Please Read Carefully:

Information in this document is provided solely in connection with ST products. STMicroelectronics NV and its subsidiaries ("ST") reserve the right to make changes, corrections, modifications or improvements, to this document, and the products and services described herein at any time, without notice.

All ST products are sold pursuant to ST's terms and conditions of sale.

Purchasers are solely responsible for the choice, selection and use of the ST products and services described herein, and ST assumes no liability whatsoever relating to the choice, selection or use of the ST products and services described herein.

No license, express or implied, by estoppel or otherwise, to any intellectual property rights is granted under this document. If any part of this document refers to any third party products or services it shall not be deemed a license grant by ST for the use of such third party products or services, or any intellectual property contained therein or considered as a warranty covering the use in any manner whatsoever of such third party products or services or any intellectual property contained therein.

UNLESS OTHERWISE SET FORTH IN ST'S TERMS AND CONDITIONS OF SALE ST DISCLAIMS ANY EXPRESS OR IMPLIED WARRANTY WITH RESPECT TO THE USE AND/OR SALE OF ST PRODUCTS INCLUDING WITHOUT LIMITATION IMPLIED WARRANTIES OF MERCHANTABILITY, FITNESS FOR A PARTICULAR PURPOSE (AND THEIR EQUIVALENTS UNDER THE LAWS OF ANY JURISDICTION), OR INFRINGEMENT OF ANY PATENT, COPYRIGHT OR OTHER INTELLECTUAL PROPERTY RIGHT.

ST PRODUCTS ARE NOT DESIGNED OR AUTHORIZED FOR USE IN: (A) SAFETY CRITICAL APPLICATIONS SUCH AS LIFE SUPPORTING, ACTIVE IMPLANTED DEVICES OR SYSTEMS WITH PRODUCT FUNCTIONAL SAFETY REQUIREMENTS; (B) AERONAUTIC APPLICATIONS; (C) AUTOMOTIVE APPLICATIONS OR ENVIRONMENTS, AND/OR (D) AEROSPACE APPLICATIONS OR ENVIRONMENTS. WHERE ST PRODUCTS ARE NOT DESIGNED FOR SUCH USE, THE PURCHASER SHALL USE PRODUCTS AT PURCHASER'S SOLE RISK, EVEN IF ST HAS BEEN INFORMED IN WRITING OF SUCH USAGE, UNLESS A PRODUCT IS EXPRESSLY DESIGNATED BY ST AS BEING INTENDED FOR "AUTOMOTIVE, AUTOMOTIVE SAFETY OR MEDICAL" INDUSTRY DOMAINS ACCORDING TO ST PRODUCT DESIGN SPECIFICATIONS. PRODUCTS FORMALLY ESCC, QML OR JAN QUALIFIED ARE DEEMED SUITABLE FOR USE IN AEROSPACE BY THE CORRESPONDING GOVERNMENTAL AGENCY.

Resale of ST products with provisions different from the statements and/or technical features set forth in this document shall immediately void any warranty granted by ST for the ST product or service described herein and shall not create or extend in any manner whatsoever, any liability of ST.

ST and the ST logo are trademarks or registered trademarks of ST in various countries.

Information in this document supersedes and replaces all information previously supplied.

The ST logo is a registered trademark of STMicroelectronics. All other names are the property of their respective owners.

© 2014 STMicroelectronics - All rights reserved

STMicroelectronics group of companies

Australia - Belgium - Brazil - Canada - China - Czech Republic - Finland - France - Germany - Hong Kong - India - Israel - Italy - Japan - Malaysia - Malta - Morocco - Philippines - Singapore - Spain - Sweden - Switzerland - United Kingdom - United States of America

www.st.com

Данный компонент на территории Российской Федерации

Вы можете приобрести в компании MosChip.

Для оперативного оформления запроса Вам необходимо перейти по данной ссылке:

<http://moschip.ru/get-element>

Вы можете разместить у нас заказ для любого Вашего проекта, будь то серийное производство или разработка единичного прибора.

В нашем ассортименте представлены ведущие мировые производители активных и пассивных электронных компонентов.

Нашей специализацией является поставка электронной компонентной базы двойного назначения, продукции таких производителей как XILINX, Intel (ex.ALTERA), Vicor, Microchip, Texas Instruments, Analog Devices, Mini-Circuits, Amphenol, Glenair.

Сотрудничество с глобальными дистрибьюторами электронных компонентов, предоставляет возможность заказывать и получать с международных складов практически любой перечень компонентов в оптимальные для Вас сроки.

На всех этапах разработки и производства наши партнеры могут получить квалифицированную поддержку опытных инженеров.

Система менеджмента качества компании отвечает требованиям в соответствии с ГОСТ Р ИСО 9001, ГОСТ РВ 0015-002 и ЭС РД 009

Офис по работе с юридическими лицами:

105318, г.Москва, ул.Щербаковская д.3, офис 1107, 1118, ДЦ «Щербаковский»

Телефон: +7 495 668-12-70 (многоканальный)

Факс: +7 495 668-12-70 (доб.304)

E-mail: info@moschip.ru

Skype отдела продаж:

moschip.ru

moschip.ru_4

moschip.ru_6

moschip.ru_9