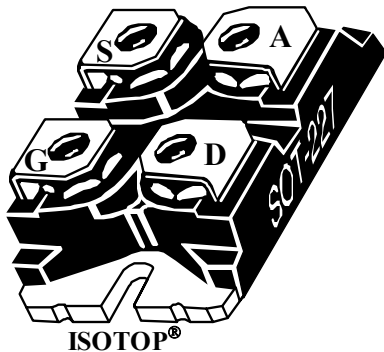
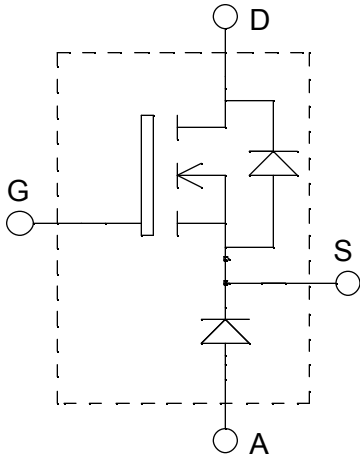


**ISOTOP<sup>®</sup> Buck chopper  
Super Junction  
MOSFET Power Module**

**$V_{DSS} = 600V$   
 $R_{DSon} = 70m\Omega$  max @  $T_j = 25^\circ C$   
 $I_D = 40A$  @  $T_c = 25^\circ C$**


**Application**

- AC and DC motor control
- Switched Mode Power Supplies

**Features**

- **COOLMOS<sup>®</sup>** Power Semiconductors
  - Ultra low  $R_{DSon}$
  - Low Miller capacitance
  - Ultra low gate charge
  - Avalanche energy rated
- ISOTOP<sup>®</sup> Package (SOT-227)
- Very low stray inductance
- High level of integration

**Benefits**

- Outstanding performance at high frequency operation
- Stable temperature behavior
- Very rugged
- Direct mounting to heatsink (isolated package)
- Low junction to case thermal resistance
- Easy paralleling due to positive  $T_c$  of  $V_{CEsat}$
- RoHS Compliant

**Absolute maximum ratings**

Symbol	Parameter	Max ratings	Unit
$V_{DSS}$	Drain - Source Breakdown Voltage	600	V
$I_D$	Continuous Drain Current	$T_c = 25^\circ C$	40
		$T_c = 80^\circ C$	30
$I_{DM}$	Pulsed Drain current	120	A
$V_{GS}$	Gate - Source Voltage	$\pm 20$	V
$R_{DSon}$	Drain - Source ON Resistance	70	$m\Omega$
$P_D$	Maximum Power Dissipation	$T_c = 25^\circ C$	290
$I_{AR}$	Avalanche current (repetitive and non repetitive)	20	A
$E_{AR}$	Repetitive Avalanche Energy	1	mJ
$E_{AS}$	Single Pulse Avalanche Energy	1800	
$I_{F_{AV}}$	Maximum Average Forward Current	Duty cycle=0.5	A
$I_{F_{RMS}}$	RMS Forward Current (Square wave, 50% duty)	$T_c = 80^\circ C$	
			39

**CAUTION:** These Devices are sensitive to Electrostatic Discharge. Proper Handling Procedures Should Be Followed.

All ratings @  $T_j = 25^\circ\text{C}$  unless otherwise specified

**Electrical Characteristics**

Symbol	Characteristic	Test Conditions	Min	Typ	Max	Unit
$I_{DSS}$	Zero Gate Voltage Drain Current	$V_{GS} = 0\text{V}, V_{DS} = 600\text{V}$			25	$\mu\text{A}$
		$T_j = 25^\circ\text{C}$				
		$T_j = 125^\circ\text{C}$			250	
$R_{DS(on)}$	Drain – Source on Resistance	$V_{GS} = 10\text{V}, I_D = 20\text{A}$			70	$\text{m}\Omega$
$V_{GS(th)}$	Gate Threshold Voltage	$V_{GS} = V_{DS}, I_D = 1\text{mA}$	2.1	3	3.9	V
$I_{GSS}$	Gate – Source Leakage Current	$V_{GS} = \pm 20\text{V}, V_{DS} = 0\text{V}$			$\pm 100$	nA

**Dynamic Characteristics**

Symbol	Characteristic	Test Conditions	Min	Typ	Max	Unit
$C_{iss}$	Input Capacitance	$V_{GS} = 0\text{V}$ $V_{DS} = 25\text{V}$ $f = 1\text{MHz}$		7015		pF
$C_{oss}$	Output Capacitance			2565		
$C_{rss}$	Reverse Transfer Capacitance			212		
$Q_g$	Total gate Charge	$V_{GS} = 10\text{V}$ $V_{Bus} = 300\text{V}$ $I_D = 40\text{A}$		259		nC
$Q_{gs}$	Gate – Source Charge			29		
$Q_{gd}$	Gate – Drain Charge			111		
$T_{d(on)}$	Turn-on Delay Time	<b>Resistive Switching</b> $V_{GS} = 15\text{V}$ $V_{Bus} = 380\text{V}$ $I_D = 40\text{A}$ $R_G = 1.8\Omega$		20		ns
$T_r$	Rise Time			30		
$T_{d(off)}$	Turn-off Delay Time			115		
$T_f$	Fall Time			10		
Eon	Turn-on Switching Energy	<b>Inductive switching @ 25°C</b> $V_{GS} = 15\text{V}, V_{Bus} = 400\text{V}$ $I_D = 40\text{A}, R_G = 5\Omega$		670		$\mu\text{J}$
Eoff	Turn-off Switching Energy			980		
Eon	Turn-on Switching Energy	<b>Inductive switching @ 125°C</b> $V_{GS} = 15\text{V}, V_{Bus} = 400\text{V}$ $I_D = 40\text{A}, R_G = 5\Omega$		1100		$\mu\text{J}$
Eoff	Turn-off Switching Energy			1206		

**Chopper diode ratings and characteristics**

Symbol	Characteristic	Test Conditions	Min	Typ	Max	Unit	
V <sub>F</sub>	Diode Forward Voltage	I <sub>F</sub> = 30A		1.6	1.8	V	
		I <sub>F</sub> = 60A		1.9			
		I <sub>F</sub> = 30A	T <sub>j</sub> = 125°C		1.4		
I <sub>RM</sub>	Maximum Reverse Leakage Current	V <sub>R</sub> = 600V			250	μA	
		V <sub>R</sub> = 600V	T <sub>j</sub> = 125°C		500		
C <sub>T</sub>	Junction Capacitance	V <sub>R</sub> = 200V		44		pF	
t <sub>rr</sub>	Reverse Recovery Time	I <sub>F</sub> =1A, V <sub>R</sub> =30V di/dt = 100A/μs	T <sub>j</sub> = 25°C	23		ns	
	Reverse Recovery Time	I <sub>F</sub> = 30A V <sub>R</sub> = 400V di/dt = 200A/μs	T <sub>j</sub> = 25°C	85			
I <sub>RRM</sub>	Maximum Reverse Recovery Current		T <sub>j</sub> = 125°C	160			
			T <sub>j</sub> = 25°C	4			
Q <sub>rr</sub>	Reverse Recovery Charge			T <sub>j</sub> = 125°C	8		A
		T <sub>j</sub> = 25°C		130			
t <sub>rr</sub>	Reverse Recovery Time	I <sub>F</sub> = 30A		T <sub>j</sub> = 125°C	70		ns
	Reverse Recovery Charge	V <sub>R</sub> = 400V			1300		nC
I <sub>RRM</sub>	Maximum Reverse Recovery Current	di/dt = 1000A/μs	30			A	

**Thermal and package characteristics**

Symbol	Characteristic	Min	Typ	Max	Unit
R <sub>thJC</sub>	Junction to Case Thermal Resistance	CoolMos		0.43	°C/W
		Diode		1.21	
R <sub>thJA</sub>	Junction to Ambient (IGBT & Diode)			20	
V <sub>ISOL</sub>	RMS Isolation Voltage, any terminal to case t = 1 min, I <sub>isol</sub> < 1mA, 50/60Hz	2500			V
T <sub>J</sub> , T <sub>STG</sub>	Storage Temperature Range	-55		150	°C
T <sub>L</sub>	Max Lead Temp for Soldering: 0.063" from case for 10 sec			300	
Torque	Mounting torque (Mounting = 8-32 or 4mm Machine and terminals = 4mm Machine)			1.5	N.m
Wt	Package Weight		29.2		g

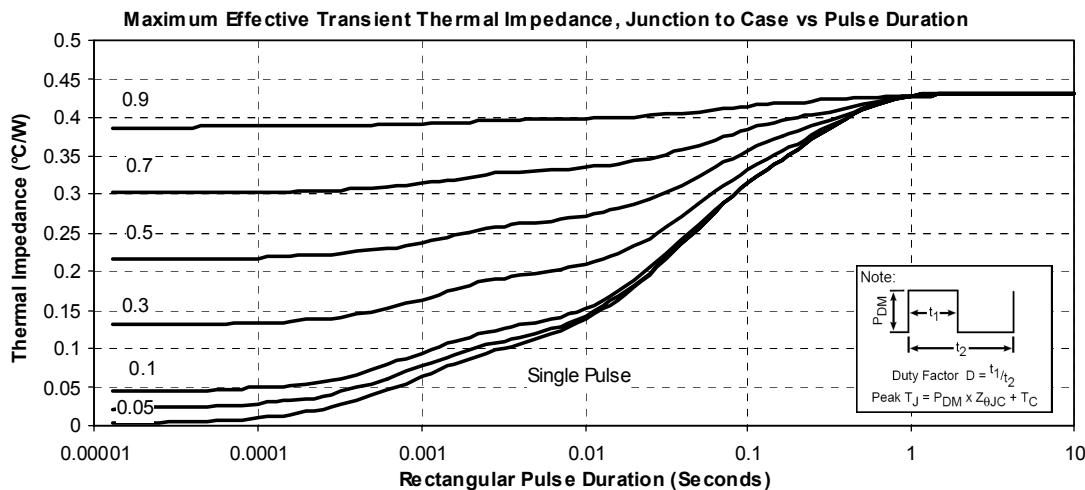
**Typical CoolMOS Performance Curve**


Fig 1, Maximum Effective transient thermal Impedance, Junction to case vs Pulse Duration

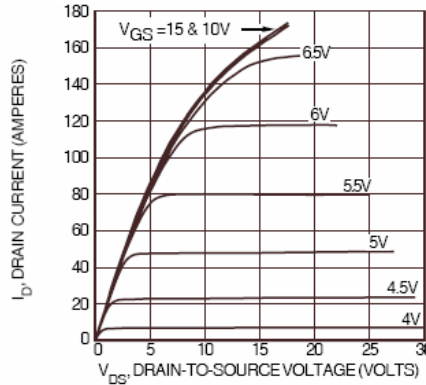


FIGURE 3, LOW VOLTAGE OUTPUT CHARACTERISTICS

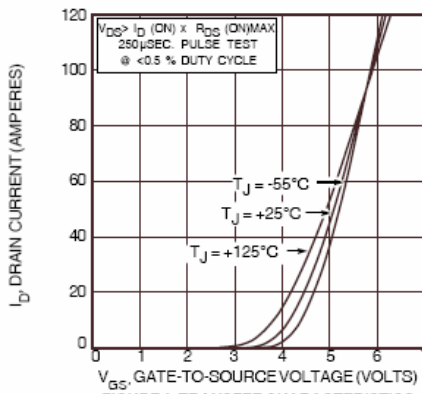


FIGURE 4, TRANSFER CHARACTERISTICS

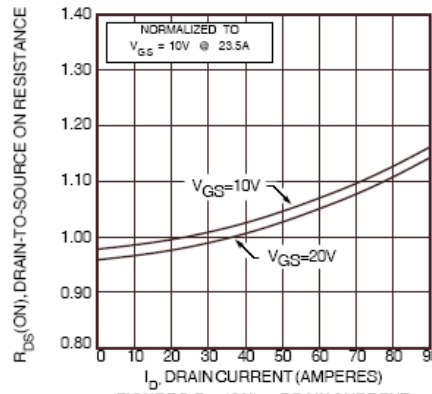


FIGURE 5,  $R_{DS(ON)}$  vs DRAIN CURRENT

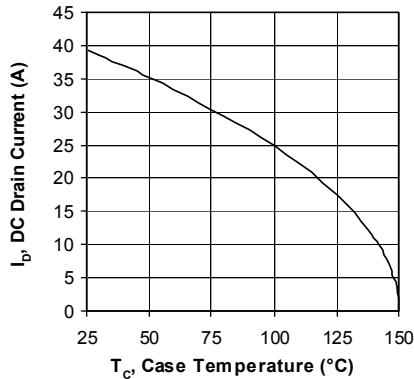


Figure 6, DC Drain Current vs Case Temperature

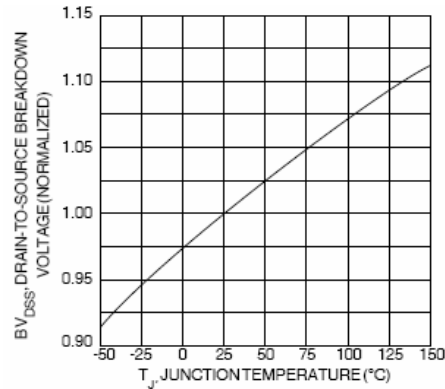


FIGURE 7, BREAKDOWN VOLTAGE vs TEMPERATURE

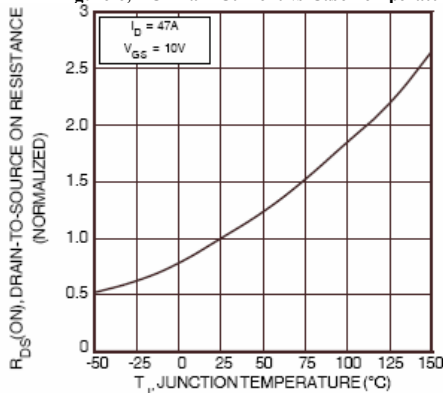


FIGURE 8, ON-RESISTANCE vs. TEMPERATURE

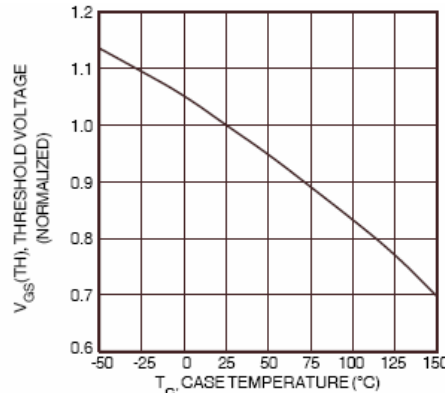


FIGURE 9, THRESHOLD VOLTAGE vs TEMPERATURE

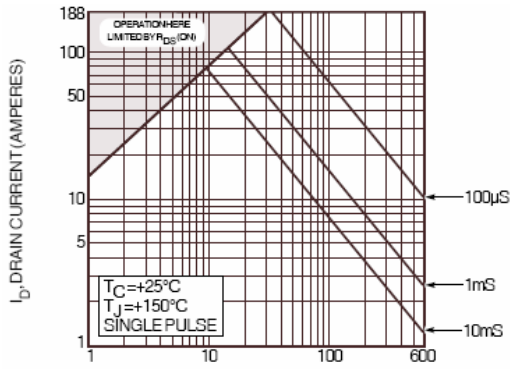


FIGURE 10, MAXIMUM SAFE OPERATING AREA

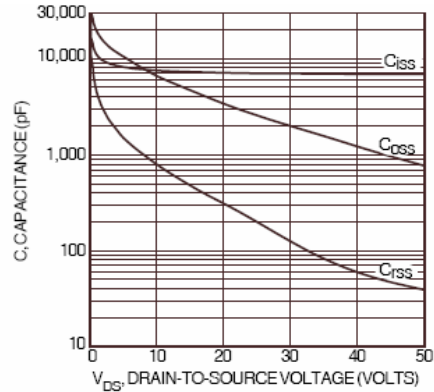


FIGURE 11, CAPACITANCE vs DRAIN-TO-SOURCE VOLTAGE

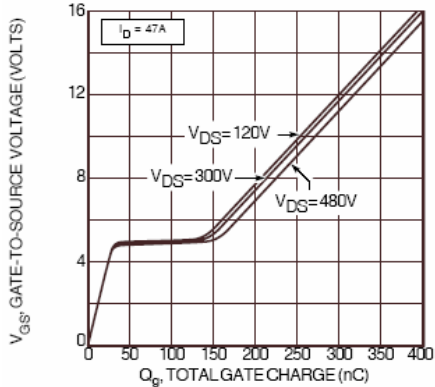


FIGURE 12, GATE CHARGES vs GATE-TO-SOURCE VOLTAGE

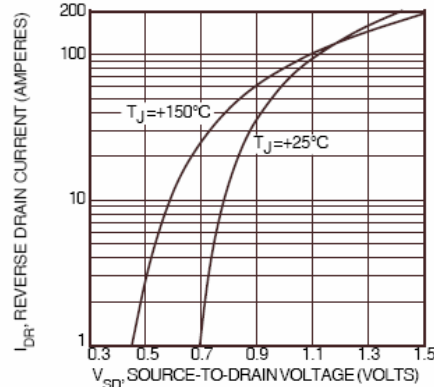


FIGURE 13, SOURCE-DRAIN DIODE FORWARD VOLTAGE

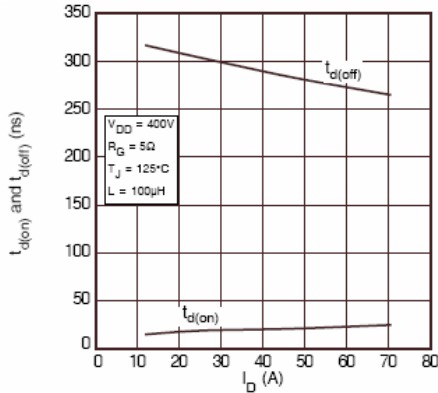


FIGURE 14, DELAY TIMES vs CURRENT

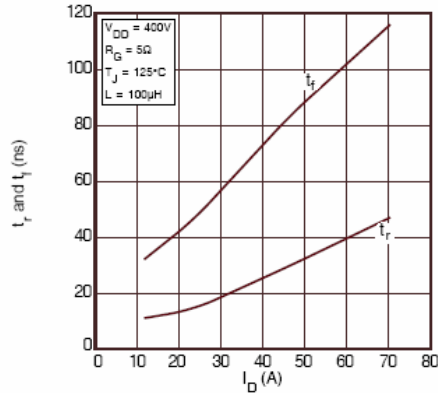


FIGURE 15, RISE AND FALL TIMES vs CURRENT

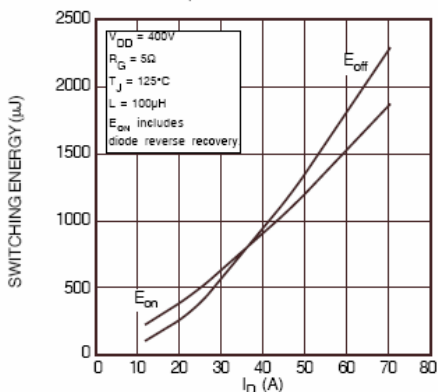


FIGURE 16, SWITCHING ENERGY vs CURRENT

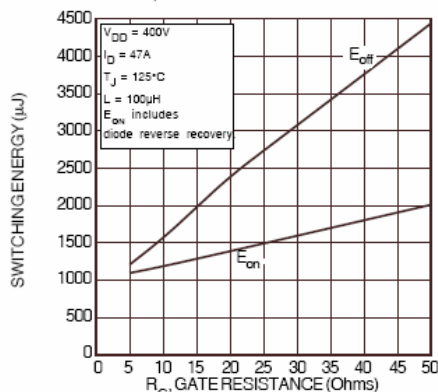


FIGURE 17, SWITCHING ENERGY vs. GATE RESISTANCE

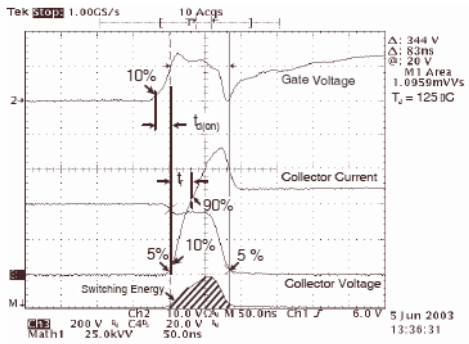


Figure 18, Turn-on Switching Waveforms and Definitions

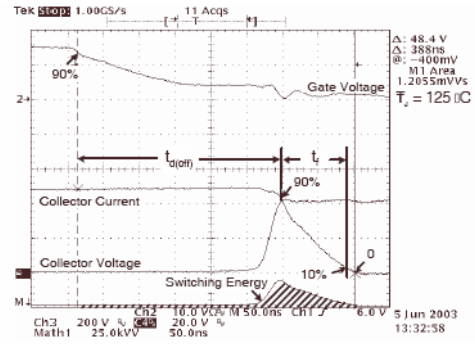


Figure 19, Turn-off Switching Waveforms and Definitions

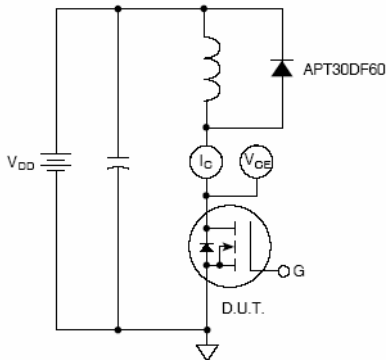


Figure 20, Inductive Switching Test Circuit

## Typical Diode Performance Curve

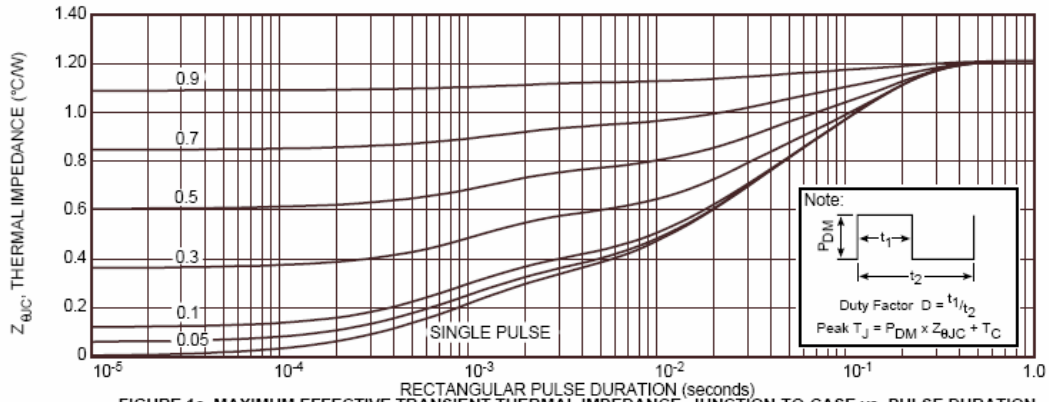


FIGURE 1a. MAXIMUM EFFECTIVE TRANSIENT THERMAL IMPEDANCE, JUNCTION-TO-CASE vs. PULSE DURATION

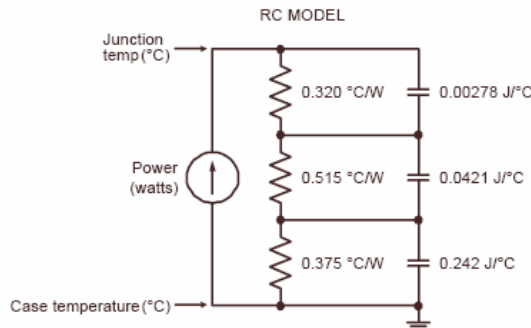


FIGURE 1b, TRANSIENT THERMAL IMPEDANCE MODEL

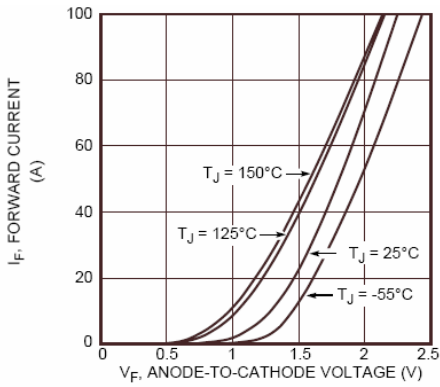


Figure 2. Forward Current vs. Forward Voltage



Figure 3. Reverse Recovery Time vs. Current Rate of Change



Figure 4. Reverse Recovery Charge vs. Current Rate of Change



Figure 5. Reverse Recovery Current vs. Current Rate of Change



Figure 6. Dynamic Parameters vs. Junction Temperature



Figure 7. Maximum Average Forward Current vs. Case Temperature

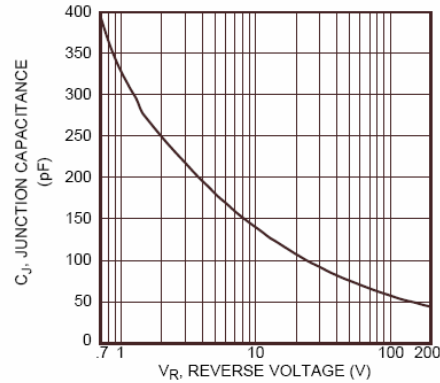


Figure 8. Junction Capacitance vs. Reverse Voltage





## Данный компонент на территории Российской Федерации

### Вы можете приобрести в компании MosChip.

Для оперативного оформления запроса Вам необходимо перейти по данной ссылке:

<http://moschip.ru/get-element>

Вы можете разместить у нас заказ для любого Вашего проекта, будь то серийное производство или разработка единичного прибора.

В нашем ассортименте представлены ведущие мировые производители активных и пассивных электронных компонентов.

Нашей специализацией является поставка электронной компонентной базы двойного назначения, продукции таких производителей как XILINX, Intel (ex.ALTERA), Vicor, Microchip, Texas Instruments, Analog Devices, Mini-Circuits, Amphenol, Glenair.

Сотрудничество с глобальными дистрибьюторами электронных компонентов, предоставляет возможность заказывать и получать с международных складов практически любой перечень компонентов в оптимальные для Вас сроки.

На всех этапах разработки и производства наши партнеры могут получить квалифицированную поддержку опытных инженеров.

Система менеджмента качества компании отвечает требованиям в соответствии с ГОСТ Р ИСО 9001, ГОСТ РВ 0015-002 и ЭС РД 009

### Офис по работе с юридическими лицами:

105318, г.Москва, ул.Щербаковская д.3, офис 1107, 1118, ДЦ «Щербаковский»

Телефон: +7 495 668-12-70 (многоканальный)

Факс: +7 495 668-12-70 (доб.304)

E-mail: [info@moschip.ru](mailto:info@moschip.ru)

Skype отдела продаж:

moschip.ru

moschip.ru\_4

moschip.ru\_6

moschip.ru\_9