



# 10-Bit, Low-Power, 2-Wire Interface, Serial, Voltage-Output DAC

MAX5811

## General Description

The MAX5811 is a single, 10-bit voltage-output digital-to-analog converter (DAC) with an I<sup>2</sup>C™-compatible 2-wire interface that operates at clock rates up to 400kHz. The device operates from a single 2.7V to 5.5V supply and draws only 100µA at V<sub>DD</sub> = 3.6V. A low-power power-down mode decreases current consumption to less than 1µA. The MAX5811 features three software-selectable power-down output impedances: 100kΩ, 1kΩ, and high impedance. Other features include an internal precision Rail-to-Rail® output buffer and a power-on reset (POR) circuit that powers up the DAC in the 100kΩ power-down mode.

The MAX5811 features a double-buffered I<sup>2</sup>C-compatible serial interface that allows multiple devices to share a single bus. All logic inputs are CMOS-logic compatible and buffered with Schmitt triggers, allowing direct interfacing to optocoupled and transformer-isolated interfaces. The MAX5811 minimizes digital noise feedthrough by disconnecting the clock (SCL) signal from the rest of the device when an address mismatch is detected.

The MAX5811 is specified over the extended temperature range of -40°C to +85°C and is available in a space-saving 6-pin SOT23 package. Refer to the MAX5812 data sheet for the 12-bit version.

## Applications

- Digital Gain and Offset Adjustments
- Programmable Voltage and Current Sources
- Programmable Attenuation
- VCO/Varactor Diode Control
- Low-Cost Instrumentation
- Battery-Operated Equipment

## Typical Operating Circuit

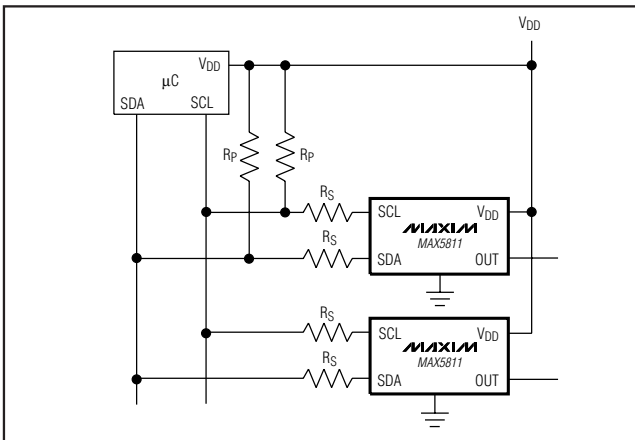

## Features

- ◆ Ultra-Low Supply Current
  - 100µA at V<sub>DD</sub> = 3.6V
  - 130µA at V<sub>DD</sub> = 5.5V
- ◆ 300nA Low-Power Power-Down Mode
- ◆ Single 2.7V to 5.5V Supply Voltage
- ◆ Fast 400kHz I<sup>2</sup>C-Compatible 2-Wire Serial Interface
- ◆ Schmitt-Trigger Inputs for Direct Interfacing to Optocouplers
- ◆ Rail-to-Rail Output Buffer Amplifier
- ◆ Three Software-Selectable Power-Down Output Impedances
  - 100kΩ, 1kΩ, and High Impedance
- ◆ Read-Back Mode for Bus and Data Checking
- ◆ Power-On Reset to Zero
- ◆ Miniature 6-Pin SOT23 Package

## Ordering Information

| PART          | TEMP RANGE     | PIN-PACKAGE | TOP MARK |
|---------------|----------------|-------------|----------|
| MAX5811LEUT-T | -40°C to +85°C | 6 SOT23-6   | AAYS     |
| MAX5811MEUT-T | -40°C to +85°C | 6 SOT23-6   | AAYU     |
| MAX5811NEUT-T | -40°C to +85°C | 6 SOT23-6   | AAYW     |
| MAX5811PEUT-T | -40°C to +85°C | 6 SOT23-6   | AAYY     |

*Functional Diagram appears at end of data sheet.*

*Rail-to-Rail is a registered trademark of Nippon Motorola, Ltd.  
I<sup>2</sup>C is a trademark of Philips Corp.*

## Pin Configuration

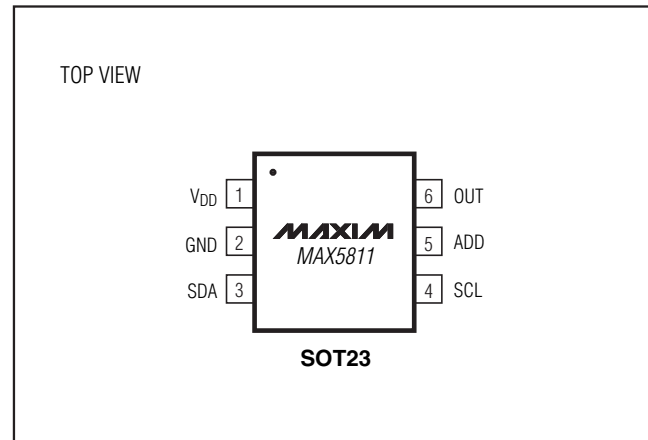

# 10-Bit Low Power 2-Wire Interface Serial, Voltage-Output DAC

## ABSOLUTE MAXIMUM RATINGS

V<sub>DD</sub>, SCL, SDA to GND .....-0.3V to +6V  
 OUT, ADD to GND .....-0.3V to V<sub>DD</sub> + 0.3V  
 Maximum Current into Any Pin.....50mA  
 Continuous Power Dissipation (T<sub>A</sub> = +70°C)  
 6-Pin SOT23 (derate 9.1mW above +70°C).....727mW

Operating Temperature Range .....-40°C to +85°C  
 Maximum Junction Temperature .....+150°C  
 Storage Temperature Range .....-65°C to +150°C  
 Lead Temperature (soldering, 10s) .....+300°C

Stresses beyond those listed under "Absolute Maximum Ratings" may cause permanent damage to the device. These are stress ratings only, and functional operation of the device at these or any other conditions beyond those indicated in the operational sections of the specifications is not implied. Exposure to absolute maximum rating conditions for extended periods may affect device reliability.

## ELECTRICAL CHARACTERISTICS

(V<sub>DD</sub> = +2.7V to +5.5V, GND = 0, R<sub>L</sub> = 5kΩ, C<sub>L</sub> = 200pF, T<sub>A</sub> = T<sub>MIN</sub> to T<sub>MAX</sub>, unless otherwise noted. Typical values are at V<sub>DD</sub> = +5V, T<sub>A</sub> = +25°C.) (Note 1)

| PARAMETER                        | SYMBOL          | CONDITIONS                                                                                          | MIN                    | TYP  | MAX                   | UNITS  |
|----------------------------------|-----------------|-----------------------------------------------------------------------------------------------------|------------------------|------|-----------------------|--------|
| <b>STATIC ACCURACY (Note 2)</b>  |                 |                                                                                                     |                        |      |                       |        |
| Resolution                       | N               |                                                                                                     | 10                     |      |                       | Bits   |
| Integral Nonlinearity            | INL             | (Note 3)                                                                                            |                        | ±0.5 | ±4                    | LSB    |
| Differential Nonlinearity        | DNL             | Guaranteed monotonic (Note 3)                                                                       |                        |      | ±0.5                  | LSB    |
| Zero-Code Error                  | ZCE             | Code = 000 hex, V <sub>DD</sub> = 2.7V                                                              |                        | ±6   | ±40                   | mV     |
| Zero-Code Error Tempco           |                 |                                                                                                     |                        | 2.3  |                       | ppm/°C |
| Gain Error                       | GE              | Code = 3FF hex                                                                                      |                        | -0.8 | -3                    | %FS    |
| Gain-Error Tempco                |                 |                                                                                                     |                        | 0.26 |                       | ppm/°C |
| <b>DAC OUTPUT</b>                |                 |                                                                                                     |                        |      |                       |        |
| Output Voltage Range             |                 | No load (Note 4)                                                                                    | 0                      |      | V <sub>DD</sub>       | V      |
| DC Output Impedance              |                 | Code = 200 hex                                                                                      |                        | 1.2  |                       | Ω      |
| Short-Circuit Current            |                 | V <sub>DD</sub> = 5V, V <sub>OUT</sub> = full scale (short to GND)                                  |                        | 42.2 |                       | mA     |
|                                  |                 | V <sub>DD</sub> = 3V, V <sub>OUT</sub> = full scale (short to GND)                                  |                        | 15.1 |                       |        |
| Wake-Up Time                     |                 | V <sub>DD</sub> = 5V                                                                                |                        | 8    |                       | μs     |
|                                  |                 | V <sub>DD</sub> = 3V                                                                                |                        | 8    |                       |        |
| DAC Output Leakage Current       |                 | Power-down mode = high impedance, V <sub>DD</sub> = 5.5V, V <sub>OUT</sub> = V <sub>DD</sub> or GND |                        | ±0.1 | ±1                    | μA     |
| <b>DIGITAL INPUTS (SCL, SDA)</b> |                 |                                                                                                     |                        |      |                       |        |
| Input High Voltage               | V <sub>IH</sub> |                                                                                                     | 0.7 x V <sub>DD</sub>  |      |                       | V      |
| Input Low Voltage                | V <sub>IL</sub> |                                                                                                     |                        |      | 0.3 x V <sub>DD</sub> | V      |
| Input Hysteresis                 |                 |                                                                                                     | 0.05 x V <sub>DD</sub> |      |                       | V      |
| Input Leakage Current            |                 | Digital inputs = 0 or V <sub>DD</sub>                                                               |                        | ±0.1 | ±1                    | μA     |
| Input Capacitance                |                 |                                                                                                     |                        | 6    |                       | pF     |
| <b>DIGITAL OUTPUT (SDA)</b>      |                 |                                                                                                     |                        |      |                       |        |
| Output Logic Low Voltage         | V <sub>OL</sub> | I <sub>SINK</sub> = 3mA                                                                             |                        |      | 0.4                   | V      |
| Three-State Leakage Current      | I <sub>L</sub>  | Digital inputs = 0 or V <sub>DD</sub>                                                               |                        | ±0.1 | ±1                    | μA     |
| Three-State Output Capacitance   |                 |                                                                                                     |                        | 6    |                       | pF     |

# 10-Bit Low Power 2-Wire Interface Serial, Voltage-Output DAC

MAX5811

## ELECTRICAL CHARACTERISTICS (continued)

(V<sub>DD</sub> = +2.7V to +5.5V, GND = 0, R<sub>L</sub> = 5kΩ, C<sub>L</sub> = 200pF, T<sub>A</sub> = T<sub>MIN</sub> to T<sub>MAX</sub>, unless otherwise noted. Typical values are at V<sub>DD</sub> = +5V, T<sub>A</sub> = +25°C.) (Note 1)

| PARAMETER                                       | SYMBOL              | CONDITIONS                                                                | MIN                    | TYP | MAX | UNITS |
|-------------------------------------------------|---------------------|---------------------------------------------------------------------------|------------------------|-----|-----|-------|
| <b>DYNAMIC PERFORMANCE</b>                      |                     |                                                                           |                        |     |     |       |
| Voltage-Output Slew Rate                        | SR                  |                                                                           |                        | 0.5 |     | V/μs  |
| Voltage-Output Settling Time                    |                     | To 1/2LSB code 100 hex to 300 hex or 300 hex to 100 hex (Note 5)          |                        | 4   | 12  | μs    |
| Digital Feedthrough                             |                     | Code = 000 hex, digital inputs from 0 to V <sub>DD</sub>                  |                        | 0.2 |     | nV-s  |
| Digital-to-Analog Glitch Impulse                |                     | Major-carry transition (code = 1FF hex to 200 hex and 200 hex to 1FF hex) |                        | 12  |     | nV-s  |
| <b>POWER SUPPLIES</b>                           |                     |                                                                           |                        |     |     |       |
| Supply Voltage Range                            | V <sub>DD</sub>     |                                                                           | 2.7                    |     | 5.5 | V     |
| Supply Current with No Load                     |                     | All digital inputs at 0 or V <sub>DD</sub> = 3.6V                         |                        | 100 | 170 |       |
|                                                 |                     | All digital inputs at 0 or V <sub>DD</sub> = 5.5V                         |                        | 130 | 190 |       |
| Power-Down Supply Current                       |                     | All digital inputs at 0 or V <sub>DD</sub> = 5.5V                         |                        | 0.3 | 1   | μA    |
| <b>TIMING CHARACTERISTICS (Figure 1)</b>        |                     |                                                                           |                        |     |     |       |
| Serial Clock Frequency                          | f <sub>SCL</sub>    |                                                                           | 0                      |     | 400 | kHz   |
| Bus-Free Time Between STOP and START Conditions | t <sub>BUF</sub>    |                                                                           | 1.3                    |     |     | μs    |
| START Condition Hold Time                       | t <sub>HD,STA</sub> |                                                                           | 0.6                    |     |     | μs    |
| SCL Pulse Width Low                             | t <sub>LOW</sub>    |                                                                           | 1.3                    |     |     | μs    |
| SCL Pulse Width High                            | t <sub>HIGH</sub>   |                                                                           | 0.6                    |     |     | μs    |
| Repeated START Setup Time                       | t <sub>SU,STA</sub> |                                                                           | 0.6                    |     |     | μs    |
| Data Hold Time                                  | t <sub>HD,DAT</sub> |                                                                           | 0                      |     | 0.9 | μs    |
| Data Setup Time                                 | t <sub>SU,DAT</sub> |                                                                           | 100                    |     |     | ns    |
| SDA and SCL Receiving Rise Time                 | t <sub>r</sub>      | (Note 5)                                                                  | 0                      |     | 300 | ns    |
| SDA and SCL Receiving Fall Time                 | t <sub>f</sub>      | (Note 5)                                                                  | 0                      |     | 300 | ns    |
| SDA Transmitting Fall Time                      | t <sub>f</sub>      | (Note 5)                                                                  | 20 + 0.1C <sub>b</sub> |     | 250 | ns    |
| STOP Condition Setup Time                       | t <sub>SU,STO</sub> |                                                                           | 0.6                    |     |     | μs    |
| Bus Capacitance                                 | C <sub>b</sub>      | (Note 5)                                                                  |                        |     | 400 | pF    |
| Maximum Duration of Suppressed Pulse Widths     | t <sub>SUP</sub>    |                                                                           | 0                      |     | 50  | ns    |

**Note 1:** All devices are 100% production tested at T<sub>A</sub> = +25°C and are guaranteed by design for T<sub>A</sub> = T<sub>MIN</sub> to T<sub>MAX</sub>.

**Note 2:** Static specifications are tested with the output unloaded.

**Note 3:** Linearity is guaranteed from codes 29 to 995.

**Note 4:** Offset and gain error limit the FSR.

**Note 5:** Guaranteed by design. Not production tested.

# 10-Bit Low Power 2-Wire Interface Serial, Voltage-Output DAC

## Typical Operating Characteristics

( $V_{DD} = +5V$ ,  $R_L = 5k\Omega$ ,  $T_A = +25^\circ C$ .)

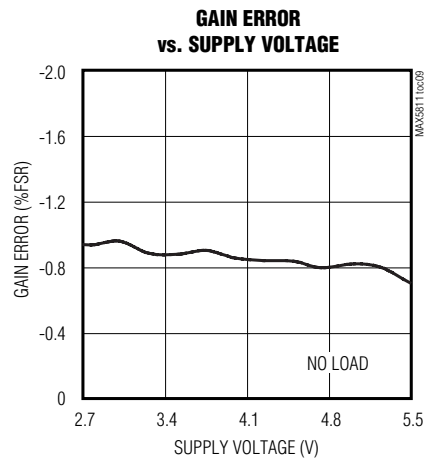
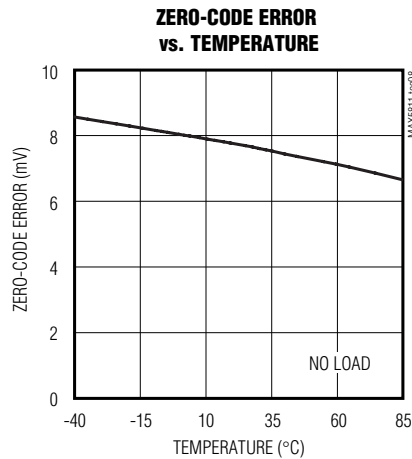
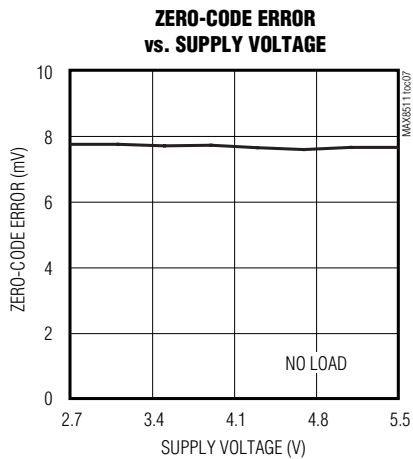
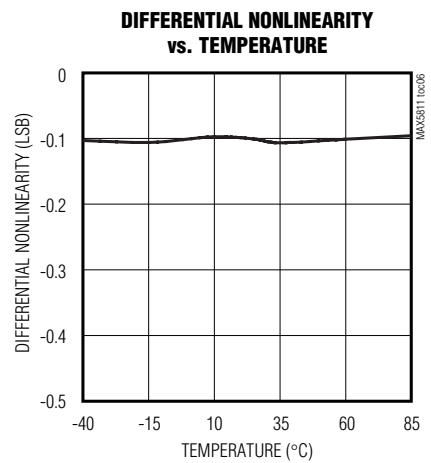
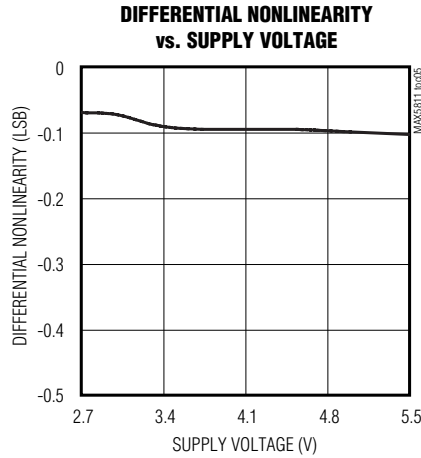
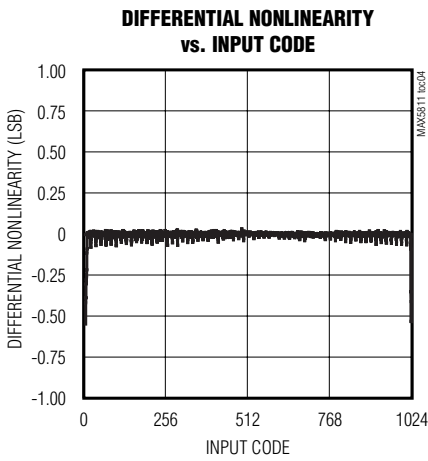
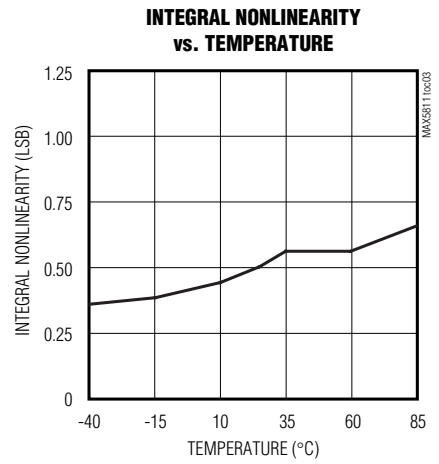
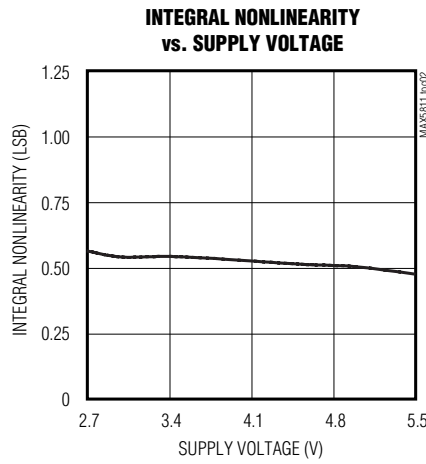
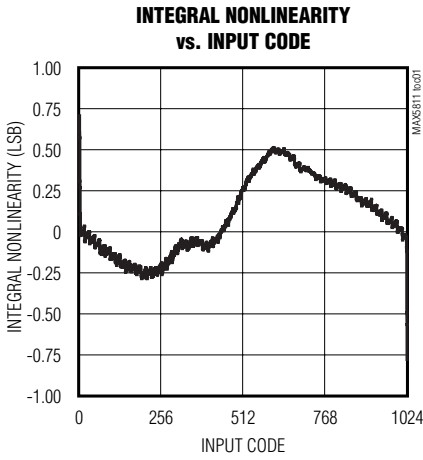

# 10-Bit Low Power 2-Wire Interface Serial, Voltage-Output DAC

MAX5811

## Typical Operating Characteristics (continued)

( $V_{DD} = +5V$ ,  $R_L = 5k\Omega$ ,  $T_A = +25^\circ C$ .)

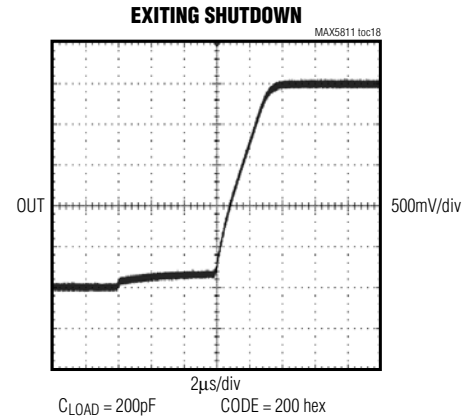
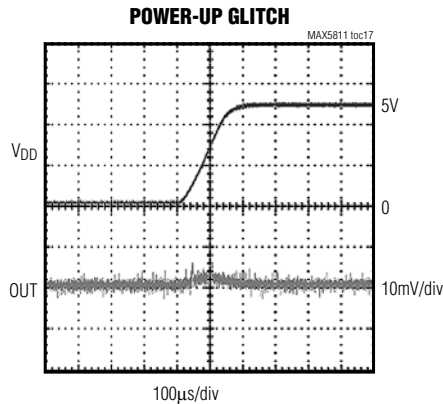
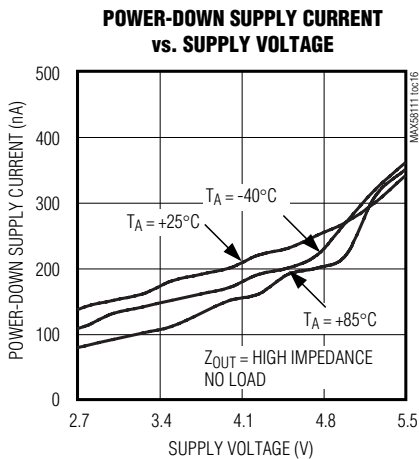
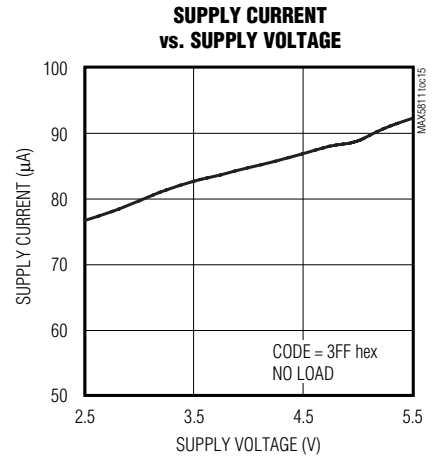
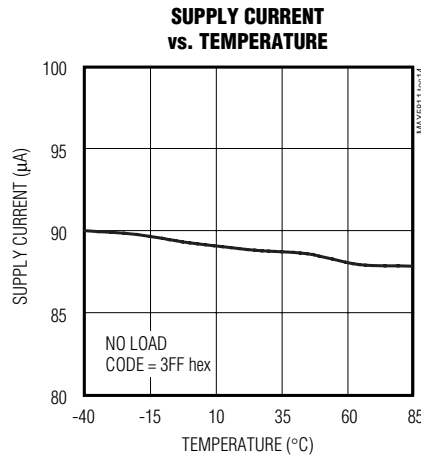
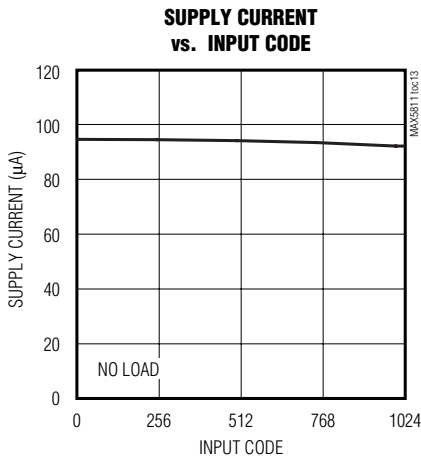
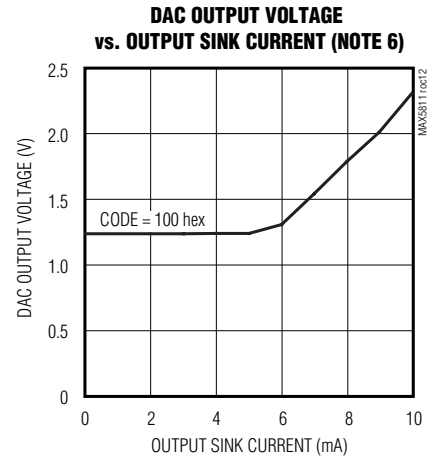
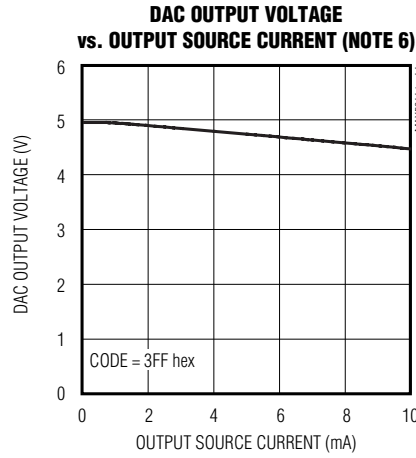
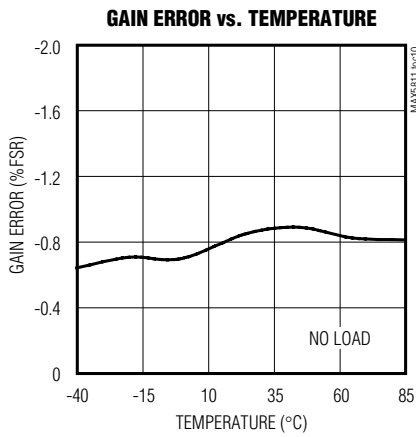

# 10-Bit Low Power 2-Wire Interface Serial, Voltage-Output DAC

## Typical Operating Characteristics (continued)

( $V_{DD} = +5V$ ,  $R_L = 5k\Omega$ ,  $T_A = +25^\circ C$ .)

**MAJOR-CARRY TRANSITION (POSITIVE)**

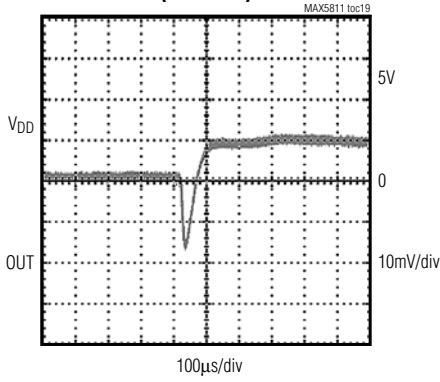

**MAJOR-CARRY TRANSITION (NEGATIVE)**

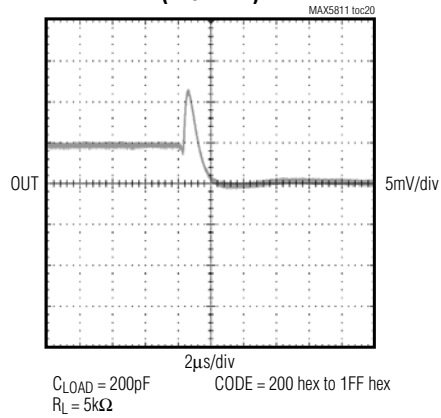

**SETTLING TIME (POSITIVE)**

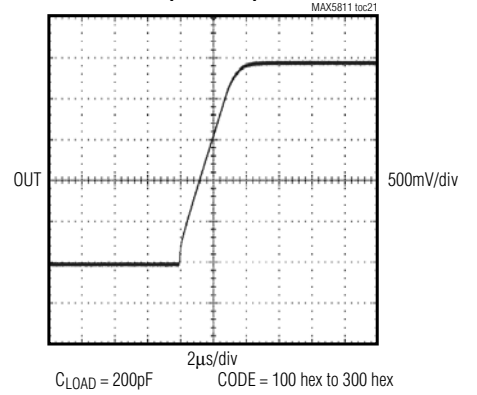

**SETTLING TIME (NEGATIVE)**

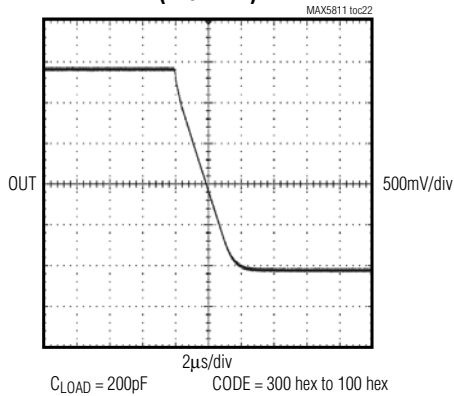

**DIGITAL FEEDTHROUGH**

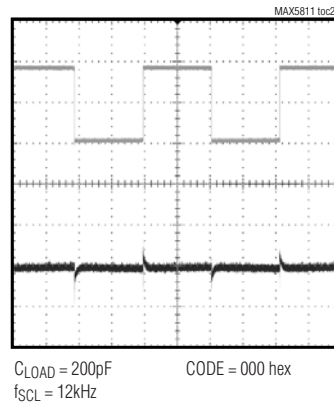

**Note 6:** The ability to drive loads less than  $5k\Omega$  is not implied.

# 10-Bit Low Power 2-Wire Interface Serial, Voltage-Output DAC

MAX5811

## Pin Description

| PIN | NAME            | FUNCTION                                                                                       |
|-----|-----------------|------------------------------------------------------------------------------------------------|
| 1   | V <sub>DD</sub> | Power Supply and DAC Reference Input                                                           |
| 2   | GND             | Ground                                                                                         |
| 3   | SDA             | Bidirectional Serial Data I/O                                                                  |
| 4   | SCL             | Serial Clock Line                                                                              |
| 5   | ADD             | Address Select. A logic high sets the address LSB to 1, a logic low sets the address LSB to 0. |
| 6   | OUT             | Analog Output                                                                                  |

## Detailed Description

The MAX5811 is a 10-bit, voltage-output DAC with an I<sup>2</sup>C/SMBus-compatible 2-wire interface. The device consists of a serial interface, power-down circuitry, input and DAC registers, a 10-bit resistor string DAC, unity-gain output buffer, and output resistor network. The serial interface decodes the address and control bits, routing the data to either the input or DAC register. Data can be directly written to the DAC register immediately updating the device output, or can be written to the input register without changing the DAC output. Both registers retain data as long as the device is powered.

### DAC Operation

The MAX5811 uses a segmented resistor string DAC architecture, which saves power in the overall system and guarantees output monotonicity. The MAX5811's input coding is straight binary, with the output voltage given by the following equation:

$$V_{OUT} = \frac{V_{REF} \times (D)}{2^N}$$

where N = 10 (bits), and D = the decimal value of the input code (0 to 1023).

### Output Buffer

The MAX5811 analog output is buffered by a precision, unity-gain follower that slews at about 0.5V/μs. The

buffer output swings rail-to-rail, and is capable of driving 5kΩ in parallel with 200pF. The output settles to ±0.5LSB within 4μs.

### Power-On Reset

The MAX5811 features an internal POR circuit that initializes the device upon power-up. The DAC registers are set to zero scale and the device is powered-down with the output buffer disabled and the output pulled to GND through the 100kΩ termination resistor. Following power-up, a wake-up command must be initiated before any conversions are performed.

### Power-Down Modes

The MAX5811 has three software-controlled low-power power-down modes. All three modes disable the output buffer and disconnect the DAC resistor string from V<sub>DD</sub>, reducing supply current draw to 300nA. In power-down mode 0, the device output is high impedance. In power-down mode 1, the device output is internally pulled to GND by a 1kΩ termination resistor. In power-down mode 2, the device output is internally pulled to GND by a 100kΩ termination resistor. Table 1 shows the power-down mode command words.

Upon wake-up, the DAC output is restored to its previous value. Data is retained in the input and DAC registers during power-down mode.

### Digital Interface

The MAX5811 features an I<sup>2</sup>C/SMBus-compatible 2-wire interface consisting of a serial data line (SDA) and

**Table 1. Power-Down Command Bits**

| POWER-DOWN COMMAND BITS |     | MODE/FUNCTION                                                                  |
|-------------------------|-----|--------------------------------------------------------------------------------|
| PD1                     | PD0 |                                                                                |
| 0                       | 0   | Power-up device. DAC output restored to previous value.                        |
| 0                       | 1   | Power-down mode 0. Power-down device with output floating.                     |
| 1                       | 0   | Power-down mode 1. Power-down device with output terminated with 1kΩ to GND.   |
| 1                       | 1   | Power-down mode 2. Power-down device with output terminated with 100kΩ to GND. |

# 10-Bit Low Power 2-Wire Interface Serial, Voltage-Output DAC

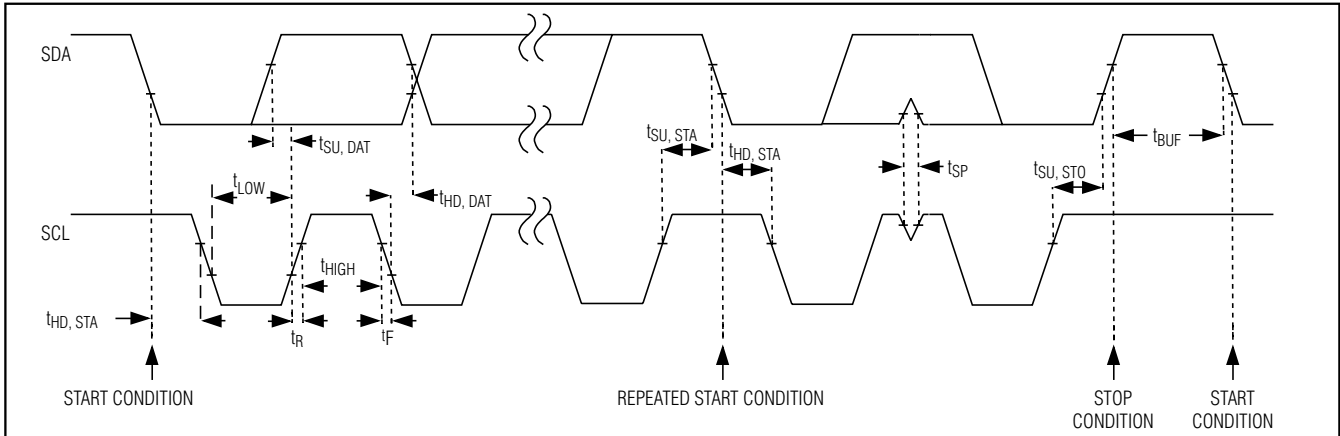

Figure 1. 2-Wire Serial Interface Timing Diagram

a serial clock line (SCL). The MAX5811 is SMBus compatible within the range of  $V_{DD} = 2.7V$  to  $3.6V$ . SDA and SCL facilitate bidirectional communication between the MAX5811 and the master at rates up to  $400kHz$ . Figure 1 shows the 2-wire interface timing diagram. The MAX5811 is a transmit/receive slave-only device, relying upon a master to generate a clock signal. The master (typically a microcontroller) initiates data transfer on the bus and generates SCL to permit that transfer.

A master device communicates to the MAX5811 by transmitting the proper address followed by command and/or data words. Each transmit sequence is framed by a START (S) or REPEATED START ( $S_r$ ) condition and a STOP (P) condition. Each word transmitted over the bus is 8 bits long and is always followed by an acknowledge clock pulse.

The MAX5811 SDA and SCL drivers are open-drain outputs, requiring a pullup resistor ( $500\Omega$  or greater) to generate a logic high voltage (see *Typical Operating Circuit*). Series resistors  $R_S$  are optional. These series resistors protect the input stages of the MAX5811 from high-voltage spikes on the bus lines, and minimize crosstalk and undershoot of the bus signals.

### Bit Transfer

One data bit is transferred during each SCL clock cycle. The data on SDA must remain stable during the high period of the SCL clock pulse. Changes in SDA while SCL is high are control signals (see *START and STOP Conditions*). SDA and SCL idle high when the I<sup>2</sup>C bus is not busy.

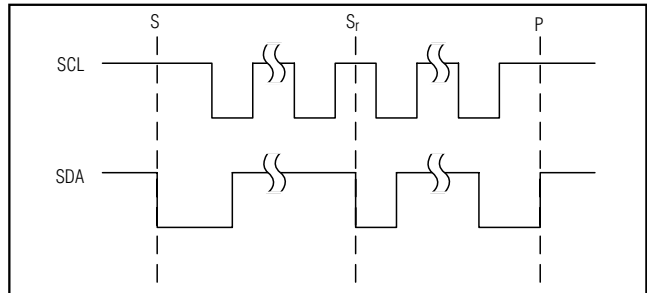

Figure 2. START/STOP Conditions

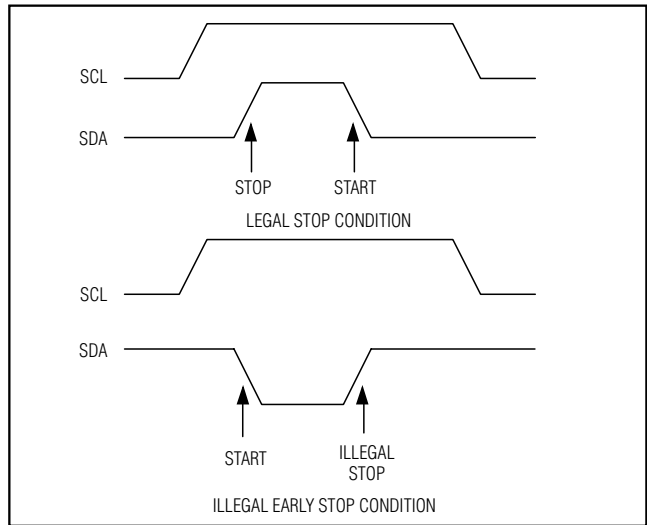

Figure 3. Early STOP Condition

### START and STOP Conditions

When the serial interface is inactive, SDA and SCL idle high. A master device initiates communication by issuing a START condition. A START condition is a high-to-



# 10-Bit Low Power 2-Wire Interface Serial, Voltage-Output DAC

MAX5811

low transition on SDA with SCL high. A STOP condition is a low-to-high transition on SDA while SCL is high (Figure 2). A START condition from the master signals the beginning of a transmission to the MAX5811. The master terminates transmission by issuing a not acknowledge followed by a STOP condition (see *Acknowledge Bit*). The STOP condition frees the bus. If a repeated START condition ( $S_r$ ) is generated instead of a STOP condition, the bus remains active. When a STOP condition or incorrect address is detected, the MAX5811 internally disconnects SCL from the serial interface until the next START condition, minimizing digital noise and feedthrough.

### Early STOP Conditions

The MAX5811 recognizes a STOP condition at any point during transmission except if a STOP condition occurs in the same high pulse as a START condition (Figure 3). This condition is not a legal I<sup>2</sup>C format; at least one clock pulse must separate any START and STOP conditions.

### Repeated START Conditions

A REPEATED START ( $S_r$ ) condition may indicate a change of data direction on the bus. Such a change occurs when a command word is required to initiate a read operation.  $S_r$  may also be used when the bus master is writing to several I<sup>2</sup>C devices and does not want to relinquish control of the bus. The MAX5811 serial interface supports continuous write operations with or without an  $S_r$  condition separating them. Continuous read operations require  $S_r$  conditions because of the change in direction of data flow.

### Acknowledge Bit (ACK)

The acknowledge bit (ACK) is the ninth bit attached to any 8-bit data word. ACK is always generated by the receiving device. The MAX5811 generates an ACK when receiving an address or data by pulling SDA low during the ninth clock period. When transmitting data, the MAX5811 waits for the receiving device to generate an ACK. Monitoring ACK allows for detection of unsuccessful data transfers. An unsuccessful data transfer occurs if a receiving device is busy or if a system fault has occurred. In the event of an unsuccessful data transfer, the bus master should reattempt communication at a later time.

### Slave Address

A bus master initiates communication with a slave device by issuing a START condition followed by the 7-bit slave address (Figure 4). When idle, the MAX5811 waits for a START condition followed by its slave address. The serial interface compares each address

**Table 2. MAX5811 I<sup>2</sup>C Slave Addresses**

| PART     | V <sub>ADD</sub> | DEVICE ADDRESS (A <sub>6</sub> ...A <sub>0</sub> ) |
|----------|------------------|----------------------------------------------------|
| MAX5811L | GND              | 0010 000                                           |
| MAX5811L | V <sub>DD</sub>  | 0010 001                                           |
| MAX5811M | GND              | 0010 010                                           |
| MAX5811M | V <sub>DD</sub>  | 0010 011                                           |
| MAX5811N | GND              | 0110 100                                           |
| MAX5811N | V <sub>DD</sub>  | 0110 101                                           |
| MAX5811P | GND              | 1010 100                                           |
| MAX5811P | V <sub>DD</sub>  | 1010 101                                           |

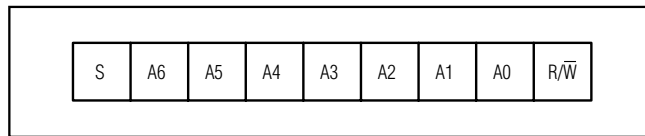

Figure 4. Slave Address Byte Definition

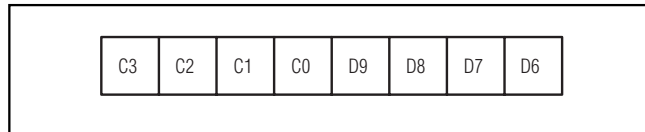

Figure 5. Command Byte Definition

value bit by bit, allowing the interface to power down immediately if an incorrect address is detected. The LSB of the address word is the Read/Write ( $R/\bar{W}$ ) bit.  $R/\bar{W}$  indicates whether the master is writing to or reading from the MAX5811 ( $R/\bar{W} = 0$  selects the write condition,  $R/\bar{W} = 1$  selects the read condition). After receiving the proper address, the MAX5811 issues an ACK by pulling SDA low for one clock cycle.

The MAX5811 has eight different factory/user-programmed addresses (Table 2). Address bits A6 through A1 are preset, while A0 is controlled by ADD. Connecting ADD to GND sets A0 = 0. Connecting ADD to V<sub>DD</sub> sets A0 = 1. This feature allows up to eight MAX5811s to share the same bus.

### Write Data Format

In write mode ( $R/\bar{W} = 0$ ), data that follows the address byte controls the MAX5811 (Figure 5). Bits C3–C0 configure the MAX5811 (Table 3). Bits D9–D0 are DAC data. Bits S1 and S0 are sub-bits and are always zero. Input and DAC registers update on the falling edge of SCL during the acknowledge bit. Should the write cycle be prematurely aborted, data is not updated and the

# 10-Bit Low Power 2-Wire Interface Serial, Voltage-Output DAC

**Table 3. Command Byte Definitions**

| SERIAL DATA INPUT |    |    |    |          |          |          | FUNCTION                                                                                                                                                                                              |
|-------------------|----|----|----|----------|----------|----------|-------------------------------------------------------------------------------------------------------------------------------------------------------------------------------------------------------|
| C3                | C2 | C1 | C0 | D9/PD1*  | D8/PD0*  | D7-D6    |                                                                                                                                                                                                       |
| 1                 | 1  | 0  | 0  | DAC DATA | DAC DATA | DAC DATA | Load DAC with new data from the following data byte and update DAC output simultaneously as soon as data is available from the serial bus. The DAC and input registers are updated with the new data. |
| 1                 | 1  | 0  | 1  | DAC DATA | DAC DATA | DAC DATA | Load input register with data from the following data byte. DAC output remains unchanged.                                                                                                             |
| 1                 | 1  | 1  | 0  | DAC DATA | DAC DATA | DAC DATA | Load input register with data from the following data byte. Update DAC output to the previously stored data.                                                                                          |
| 1                 | 1  | 1  | 1  | X        | X        | XX       | Update DAC output from input register. The device ignores any new data.                                                                                                                               |
| 1                 | 0  | X  | X  | X        | X        | XX       | Read data request. Data bits are ignored. The contents of the DAC register are available on the bus.                                                                                                  |
| 0                 | 1  | X  | X  | 0        | 0        | XX       | Power up the device.                                                                                                                                                                                  |
| 0                 | 1  | X  | X  | 0        | 1        | XX       | Power-down mode 0. Power down device with output floating.                                                                                                                                            |
| 0                 | 1  | X  | X  | 1        | 0        | XX       | Power-down mode 1. Power down device with output terminated with 1kΩ to GND.                                                                                                                          |
| 0                 | 1  | X  | X  | 1        | 1        | XX       | Power-down mode 2. Power down device with output terminated with 100kΩ to GND.                                                                                                                        |

\*When C3 = 0 and C2 = 1, data bits D9 and D8 write to the power-down registers (PD1 and PD0).  
X = Don't care.

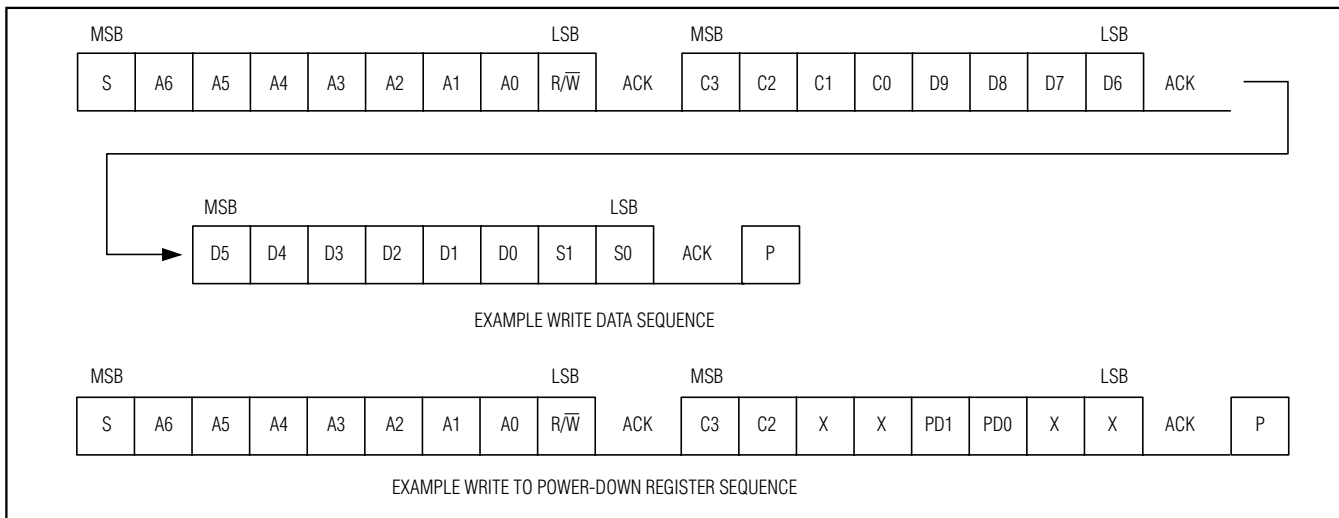

Figure 6. Example Write Command Sequences

write cycle must be repeated. Figure 6 shows two example write data sequences.

**Read Data Format**

In read mode ( $R/\overline{W} = 1$ ), the MAX5811 writes the contents of the DAC register to the bus. The direction of

# 10-Bit Low Power 2-Wire Interface Serial, Voltage-Output DAC

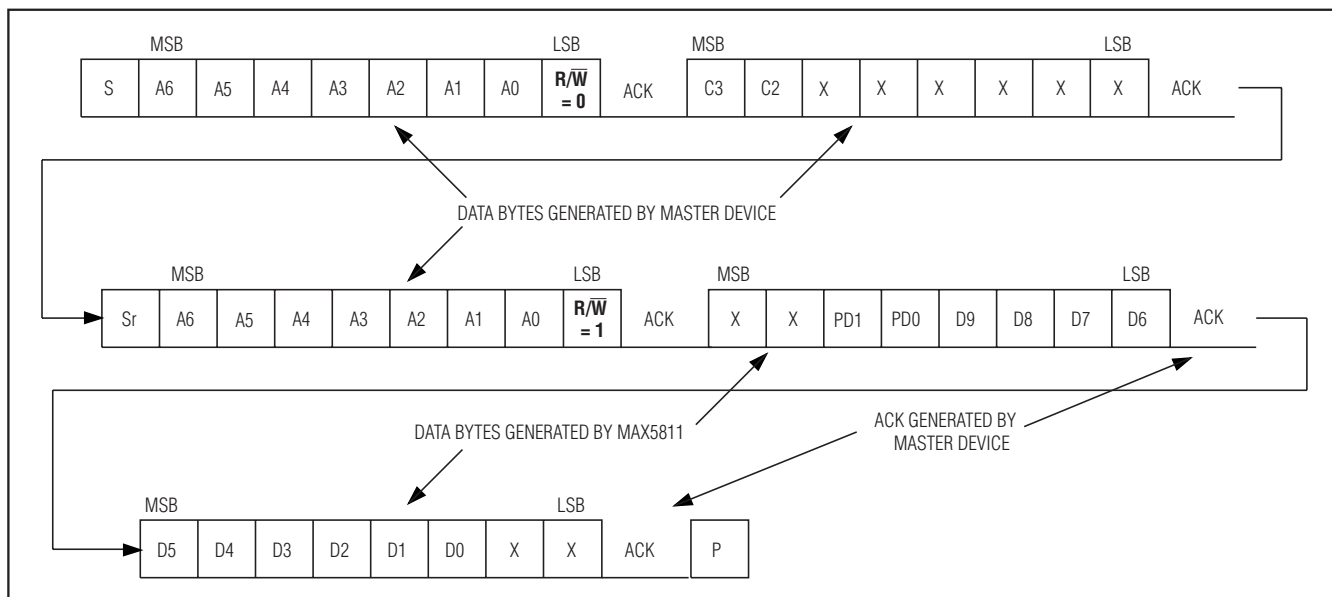

Figure 7. Read Word Data Sequence

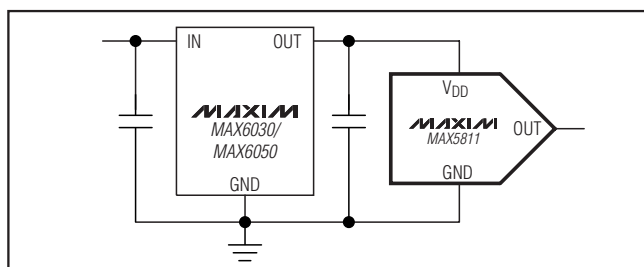

Figure 8. Powering the MAX5811 from an External Reference

data flow reverses following the address acknowledge by the MAX5811. The device transmits the first byte of data, waits for the master to acknowledge, then transmits the second byte. Figure 7 shows an example read data sequence.

### I<sup>2</sup>C Compatibility

The MAX5811 is compatible with existing I<sup>2</sup>C systems. SCL and SDA are high-impedance inputs; SDA has an open drain that pulls the data line low during the ninth clock pulse. The *Typical Operating Circuit* shows a typical I<sup>2</sup>C application. The communication protocol supports the standard I<sup>2</sup>C 8-bit communications. The general call address is ignored. The MAX5811 address is compatible with the 7-bit I<sup>2</sup>C addressing protocol only. No 10-bit address formats are supported.

### Digital Feedthrough Suppression

When the MAX5811 detects an address mismatch, the serial interface disconnects the SCL signal from the core circuitry. This minimizes digital feedthrough caused by the SCL signal on a static output. The serial interface reconnects the SCL signal once a valid START condition is detected.

### Applications Information

#### Powering the Device from an External Reference

The MAX5811 uses the V<sub>DD</sub> as the DAC voltage reference. Any power-supply noise is directly coupled to the device output. The circuit in Figure 8 uses a precision voltage reference to power the MAX5811, isolating the device from any power-supply noise. Powering the MAX5811 in such a manner greatly improves overall performance, especially in noisy systems. The MAX6030 (3V, 75ppm/°C) or the MAX6050 (5V, 75ppm/°C) precision voltage references are ideal choices due to the low power requirements of the MAX5811.

#### Digital Inputs and Interface Logic

The MAX5811 2-wire digital interface is I<sup>2</sup>C and SMBus compatible. The two digital inputs (SCL and SDA) load the digital input serially into the DAC. Schmitt-trigger buffered inputs allow slow-transition interfaces such as

# 10-Bit Low Power 2-Wire Interface Serial, Voltage-Output DAC

## Functional Diagram

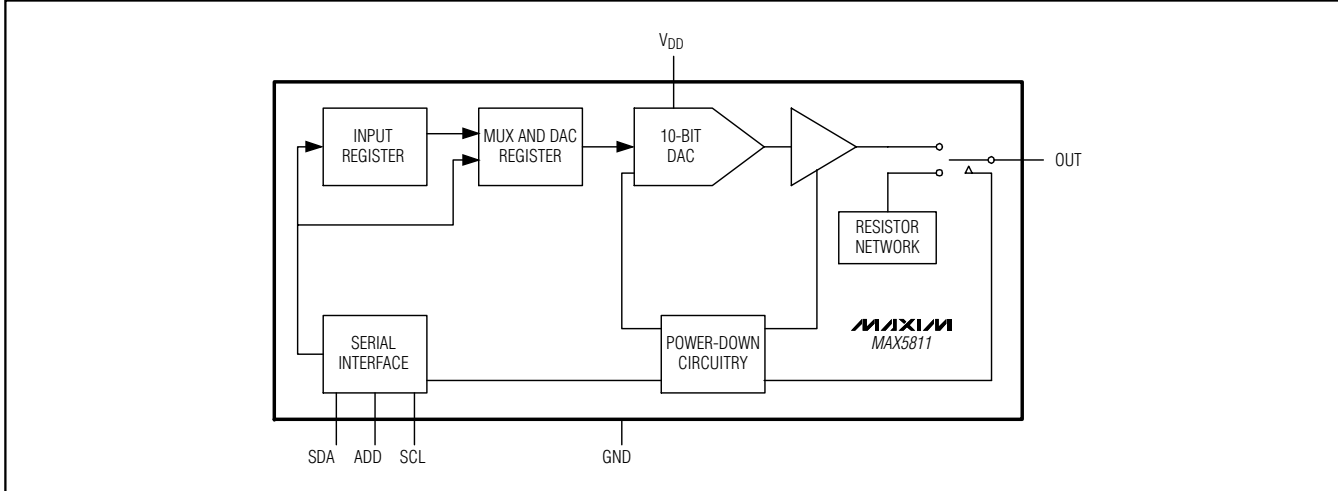

optocouplers to interface directly to the device. The digital inputs are compatible with CMOS logic levels.

### Power-Supply Bypassing and Ground Management

Careful PC board layout is important for optimal system performance. Keep analog and digital signals separate to reduce noise injection and digital feedthrough. Use a ground plane to ensure that the ground return from GND to the power-supply ground is short and low impedance. Bypass  $V_{DD}$  with a  $0.1\mu\text{F}$  capacitor to ground as close to the device as possible.

## Selector Guide

| PART        | ADDRESS  |
|-------------|----------|
| MAX5811LEUT | 0010 00X |
| MAX5811MEUT | 0010 01X |
| MAX5811NEUT | 0110 10X |
| MAX5811PEUT | 1010 10X |

## Chip Information

TRANSISTOR COUNT: 7172

PROCESS: BiCMOS

# 10-Bit Low Power 2-Wire Interface Serial, Voltage-Output DAC

## Package Information

(The package drawing(s) in this data sheet may not reflect the most current specifications. For the latest package outline information go to [www.maxim-ic.com/packages](http://www.maxim-ic.com/packages).)

MAX5811

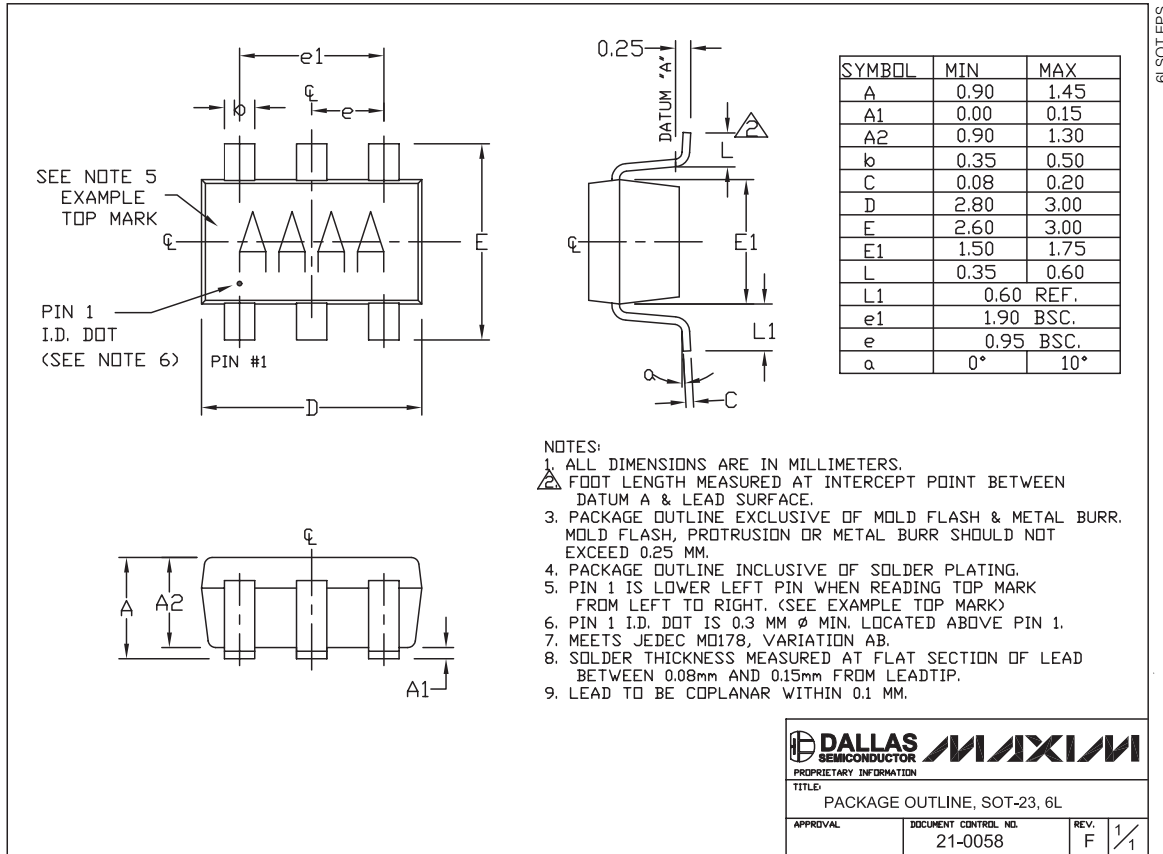

Maxim cannot assume responsibility for use of any circuitry other than circuitry entirely embodied in a Maxim product. No circuit patent licenses are implied. Maxim reserves the right to change the circuitry and specifications without notice at any time.

Maxim Integrated Products, 120 San Gabriel Drive, Sunnyvale, CA 94086 408-737-7600 13

## Данный компонент на территории Российской Федерации

### Вы можете приобрести в компании MosChip.

Для оперативного оформления запроса Вам необходимо перейти по данной ссылке:

<http://moschip.ru/get-element>

Вы можете разместить у нас заказ для любого Вашего проекта, будь то серийное производство или разработка единичного прибора.

В нашем ассортименте представлены ведущие мировые производители активных и пассивных электронных компонентов.

Нашей специализацией является поставка электронной компонентной базы двойного назначения, продукции таких производителей как XILINX, Intel (ex.ALTERA), Vicor, Microchip, Texas Instruments, Analog Devices, Mini-Circuits, Amphenol, Glenair.

Сотрудничество с глобальными дистрибьюторами электронных компонентов, предоставляет возможность заказывать и получать с международных складов практически любой перечень компонентов в оптимальные для Вас сроки.

На всех этапах разработки и производства наши партнеры могут получить квалифицированную поддержку опытных инженеров.

Система менеджмента качества компании отвечает требованиям в соответствии с ГОСТ Р ИСО 9001, ГОСТ РВ 0015-002 и ЭС РД 009

### Офис по работе с юридическими лицами:

105318, г.Москва, ул.Щербаковская д.3, офис 1107, 1118, ДЦ «Щербаковский»

Телефон: +7 495 668-12-70 (многоканальный)

Факс: +7 495 668-12-70 (доб.304)

E-mail: [info@moschip.ru](mailto:info@moschip.ru)

Skype отдела продаж:

moschip.ru

moschip.ru\_4

moschip.ru\_6

moschip.ru\_9