



RJFTVX, USBFTVX, RJ11FTVX

RJ45, USB, RJ11/12 explosion proof solutions for Zone 2



Amphenol Atex Field Bus range is designed for device group II category 3G. According to EN60079-15 it may be operated within zone 2 and class I, Division 2, as low power non sparking connectors.

RJFTVX • Rugged and sealed RJ45 connector



RJFTVX allows you to use an Ethernet Class D / Cat. 5e connection for 10 BaseT, 100 BaseTx or 1000 BaseT networks in ATEX zone 2 environments. With the patented RJStop system you can use a standard RJ45 cordset in a metallic plug which will protect it from shocks, dust and fluids. RJFTVX features the same main characteristics than RJFTV series (see page 14)

CHARACTERISTICS

Ex marking	II3G ExnAIIIT6 X
Operating temperature range	-40°C / +60°C
Voltage	60 Veff max
Power	20 W max
Outside cable diameter	6mm to 12mm
Sealing	IP68
Data transmission	10 BaseT, 100 BaseTX & 1000 BaseT networks. Cat. 5e per TIA/EIA 568B & Class D per ISO/IEC 11801

RJFTVX6 PLUG

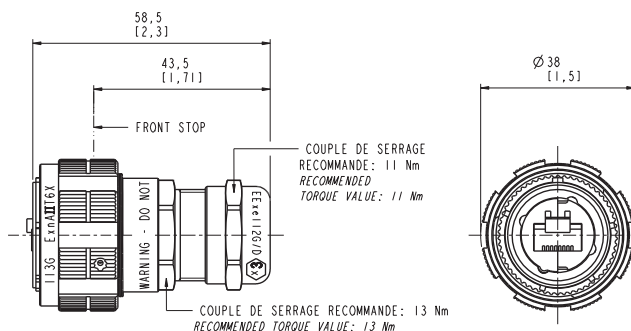

PART NUMBERS:

Nickel Plated plug: **RJFTVX6MN**
Olive drab cadmium plug: **RJFTVX6MG**

IP68 metallic cap: **RJFTVC6N**
IP68 metallic cap: **RJFTVC6G**

RJFTVX2 receptacle



PART NUMBERS:

RECEPTACLE
Nickel Plated • RJ45 back termination • coding A: **RJFTVX2SA1N**
Olive drab cadmium • RJ45 back termination • coding A: **RJFTVX2SA1G**

RECEPTACLE CAP
Nickel: **RJFTVC2N**
Olive drab cadmium: **RJFTVC2G**



USBTX2 & USBTX2 receptacles

Square Flange Receptacle Type USBFTV2



Cable end Type "A" (Standard USB "A" Plug)



Cable end Type "OPEN" (No connector)

Jam Nut Receptacle Type USBFTV7

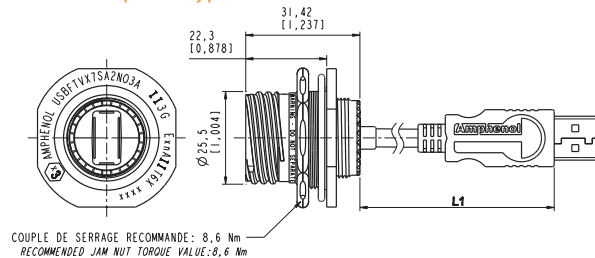

Cable end Type "A" (Standard USB "A" Plug)

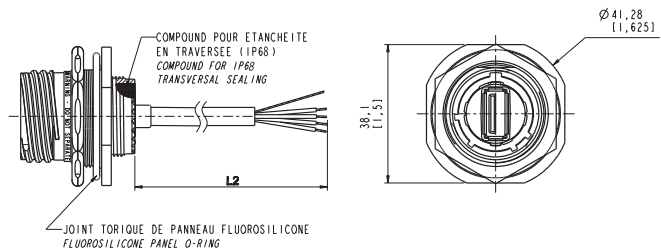

Cable end Type "OPEN" (No connector)

RECEPTACLE CAPS PART NUMBERS:

Nickel plated cap for USBFTVX2: **USBFTVC2N**

Nickel plated cap for USBFTVX7: **USBFTVC7N**

Olive drab cadmium cap for USBFTVX2: **USBFTVC2G**

Olive drab cadmium cap for USBFTVX7: **USBFTVC7G**

Series	USBFTVX							2S	A	2	N	03	A
USB Field TV													
Shell Type													
2S:	Square flange receptacle							7S:	Jam nut receptacle				
Coding													
"A" (Standard) or "B"													
Back Terminations													
2:	Rugged USB cable												
Shells Plating													
N:	Nickel							G:	Olive drab cadmium plating				
USB cable length													
03:	30 cm [11.81 inches]							05:	50 cm [19.68 inches]		10:	1 meter [39.37 inches]	
USB cable end													
A:	Standard USB-A plug							OPEN:	Open cable (no connector)				

RJ11FTVX • Rugged and sealed RJ11/12 connector



RJ11FTVX allows you to use a standard phone RJ11 / RJ12 connection in ATEX zone 2 environments. With the patented RJStop® system you can use a standard RJ11 / RJ12 cordset in a metallic plug which will protect it from shocks, dust and fluids.

CHARACTERISTICS

Ex marking	IIG ExnAII T6 X
Operating temperature range	-40°C / +60°C
Voltage	60 Veff max
Power	20 W max
Outside cable diameter	4mm to 5.5mm
Sealing	IP68
Coupling mechanism	Tri Start thread with anti-decoupling device (MIL-DTL-38999 series III)
Mating cycles	500 min
Salt spray	48h with nickel plating / 500 h with olive drab cadmium plating
Coding	4 mechanical user-defined coding / Polarization settings (insert rotation)
Fire retardant / Low Smoke	UL94 V0 and NF16 101 & 16 102
R11 cordset retention in the plug	100 N in the Axis



RJ11FTVX6 PLUG



PART NUMBERS:

PLUG

Nickel plated: **RJF11TVX6MN**

Olive drab cadmium: **RJ11FTVX6MG**

CAP

Nickel plated: **RJ11FTVC6N**

Olive drab cadmium: **RJ11FTVC6G**

RJ11FTVX2

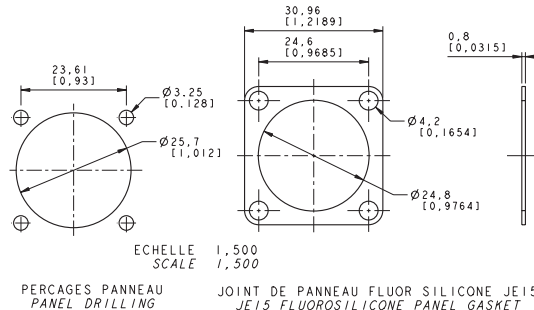
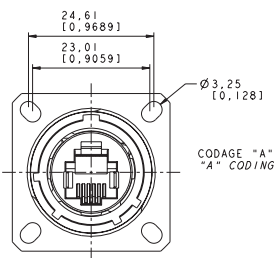
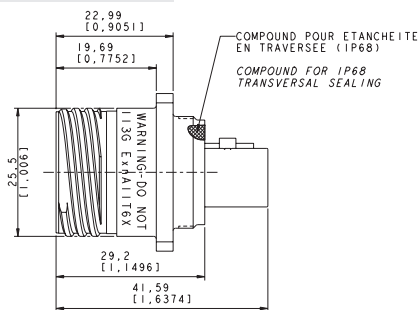

PART NUMBERS:

RECEPTACLE

Nickel Plated - Female RJ45 back termination – coding A: **RJ11FTVX2SA1N**

Olive drab cadmium - Female RJ45 back termination – coding A: **RJ11FTVX2SA1G**

RECEPTACLE CAP

Nickel plated: **RJ11FTVC2N**

Olive drab cadmium: **RJ11FTVC2G**

RJ11FTVX7



PART NUMBERS:

RECEPTACLE

Nickel Plated - Female RJ45 back termination - coding A: **RJ11FTVX7SA1N**

Olive drab cadmium - Female RJ45 back termination - coding A: **RJ11FTVX7SA1G**

RECEPTACLE CAP

Nickel: **RJ11FTVC7N**

Olive drab cadmium: **RJ11FTVC7G**

INSERTS CODING

CONNECTION SIDE VIEWS

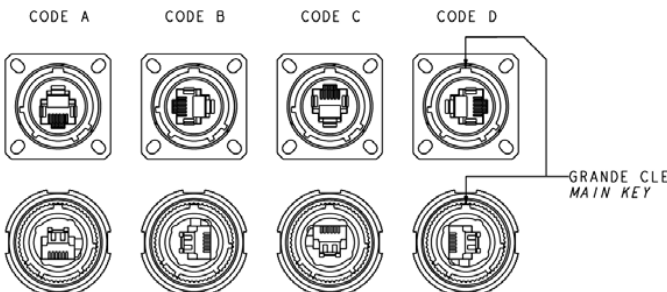

REMARK:

As receptacles are compounded (IP68 transversally sealing), coding position has to be specified in the part number: "A" (standard), "B", "C" or "D".



RJ SWITCH

Industrial Gigabit Ethernet Switch IP30



Applications

- Factory Automation
- Robotics
- Process Control
- Transportation Systems
- Data Acquisition & Transmission

INDUSTRIAL RUGGED ETHERNET SWITCH

Amphenol offers a full range of Rugged Ethernet switches for industrial use. These switches are specifically designed for industrial applications where Real-Time is a key requirement. The wide range, from unmanaged Plug & Play switches to those managed with fiber optics ports, will fulfill all your needs. This family of switches, IP30 rated, is suitable for both Din-Rail or flat panel mounting. This is an easy way to make the Ethernet networks of your manufacturing site, automation or control units deterministic.

This wide range of Ethernet switches is available with following features:

- Unmanaged, Real-Time Ring and Managed models
- RJ45 ports and up to two fiber optics ports (multimode or singlemode)
- 5 or 9 port models
- **Up to 3 Gigabit ports are offered**

KEY FEATURES

- Redundant power inputs with surge/spike protection
- Ultra reliable 1,000,000 hours MTBF
- Hazardous location: operation in Zone 2
- Wide operating temperature range of -40°C to 70/85°C
- Rugged metal packaging with DIN rail or direct panel mounting
- Auto-detecting, auto-crossover and auto-polarity
- Full-Duplex operation with flow control (no collisions!)
- Ring Switch Networking Features
 - Real-Time Ring for ultra-fast fault-tolerant loops
 - Recovery time of 30 ms + 5 ms per hop!
 - Ideal for deterministic systems and PLCs
 - Real-time traffic prioritization
 - Port mirroring for traffic diagnostic
 - 3 ports 10/100/1000 - BaseT(X) (*)
- Managed Switch Networking Features
 - Rapid Spanning Tree (RSTP) for fast redundant rings
 - Priority queuing for real-time performance (QoS and CoS)
 - SNMP v1 and v2 for network management
 - SNMPv3 for authentication and encryption
 - IGMP for multicast filtering
 - VLAN for traffic segregation
 - User friendly configuration (web, Telnet, RS232)
 - Encryption using HTTPS, SSL, SSH, SNMPv3
 - Message filtering to stop broadcast storms
 - RMON and port mirroring for diagnostics
 - The Power of Linux Inside
 - 3 ports 10/100/1000 - BaseT(X) (*)

Dimensions (example for 5 Port Ring Models)



Power and alarm wiring

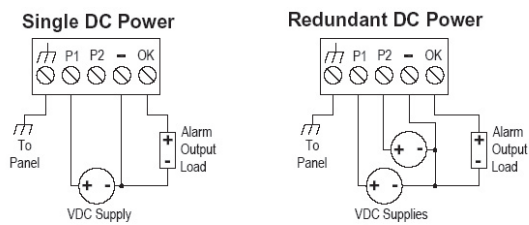

Description



- 1 SC or ST fiber connector (1, 2 or none)
- 2 DIN-Rail or Panel Mounting Fixture
- 3 5 or 9 connectors (RJ45, SC or ST fiber)
- 4 Unmanaged, Ring or Managed Capability
- 5 Indicators for Power, Alarm Output Status
- 6 Indicators for Link Status and Datarate
 - 10 Mbps
 - 100 Mbps
 - 1000 Mbps
- 7 Terminal block for Redundant Power Inputs + Alarm Output
- 8 IP30 Iridized Aluminum Enclosure

RJ Switch

Amphenol



MANAGED, RING & UNMANAGED SWITCH FEATURES

IEEE Ethernet Standards

Models	Features	802.3/u	802.3x	802.3z	802.1p	802.1D	802.1w	802.1Q
RJS 9ES	Unmanaged	✓	✓					
RJS 9RS	RING	✓	✓		✓			
RJS 9RG	RING - Gigabit	✓	✓	✓	✓			
RJS 9MS	Managed	✓	✓		✓	✓	✓	✓
RJS 9MG	Managed - Gigabit	✓	✓	✓	✓	✓	✓	✓

IEEE 802.3 /u	10 Mbps Ethernet & 100 Mbps Fast Ethernet	IEEE 802.1p	Priority queuing – QoS, CoS, ToS/DS
IEEE 802.3x	Full-Duplex with Flow Control	IEEE 802.1D/w	Rapid Spanning Tree for redundant rings
IEEE 802.3z	1000 Mbps Gigabit Ethernet	IEEE 802.1Q	VLAN for traffic segregation

Regulatory Approvals

EMI emissions	EN55022, FCC part 15, ICES-003
EMC immunity	IEC61326-1, IEEE C37.90
Shocks	IEC60068-2-27
Vibrations	IEC60068-2-6
Free Fall	IEC60068-2-32
Hazardous Location	UL1604, CSA C22.2/213 (Class 1, Div. 2), EN50021/Zone 2 EN 60079-15 (Zone 2 locations - EEx nA II T4 x)

Ethernet features

RJ45 ports	5 or 9 Shielded RJ45 ports 10/100 or 1000 BaseT(x)
Fiber optic ports	LC or SC or ST connectors Data rate 100BaseFX (100Mbps) or 1000 Mbps for 9RG & 9MG models Wavelength 1300 nm center Fiber multimode (mm) optimal: 62.5/125 um Fiber singlemode (sm) optimal: 9/125 um Fiber max distance (Full duplex): 2km (mm), 15 or 40 km (sm) (except gigabit) 0,5km (mm), 10km (sm) for 9RG & 9MG models
Ethernet switch type	Intelligent store & forward
Full / Half Duplex	Configurable
RJ45 speed	10, 100 or 1000 Mbps auto-negotiation
RJ45 MDI/MDIX	Auto-crossover connection
RJ45 TD and RD polarity	Auto-polarity
Typical latency	16 us + frame time @ 10 Mbps (varies on load and settings) 5 us + frame time @ 100 Mbps
MAC addresses supported	8192 (MG & RG); 2048 for all other models
Memory bandwidth	32 Gbps (MG & RG); 3.2 Gbps for all other models

Environmental

Operating Temperature	- 40°C to +85°C (5 ports model + RJS 9ES) - 40°C to +70°C (All other models)
Storage Temperature	- 40°C to +85°C
Humidity (non-condensing)	5 to 95 % RH

Status Ring & Managed models only

"OK" contact output (or 10 - 50V DC depends on models)	10 – 30V DC Maximum current 0.5 A
---	--

Power Supply

Input Power (depends on models)	2 W to 9W typical, all ports active at 100 Mbps
Redundant Inputs	10 - 50V DC (models RJS-5RS; RJS-9RS) 10 - 30V DC (all other models)

EXCEEDS MIL-STD-1275

Power protection rating	Industrial	MIL-STD-1275
Surge protection		Available on: RJS-5RS / RJS-9RS RJS-9MS -4 & -5 100 V for 1s
Transient protection	15 KW peaks	15 KW peaks
Spike protection	5 KW (10 times for 10 µs)	5 KW (10 times for 10 µs) 250 V (50 times for 100 µs)



Part Number Code

Series	RJS	5ES	1	-	-
RJ-Switch					
Type of Electronics					
5ES: 5 ports total, Ethernet unmanaged switch					
9ES: 9 ports total, Ethernet unmanaged switch					
5RS: 5 ports total, Ethernet Ring switch					
9RS: 9 ports total, Ethernet Ring switch					
5MS: 5 ports total, Ethernet Managed switch					
9MS: 9 ports total, Ethernet Managed switch					
RJ45 or fiber ports					
1: RJ45 ports only, no fiber					
2: 1 multimode fiber ports					
3: 1 singlemode fiber ports					
4: 2 multimode fiber ports (except for 9ES- models)					
5: 2 singlemode fiber ports (except for 9ES- models)					
Style of Fiber connectors					
Blank: No fiber					
SC: SC style fiber connector(s)					
ST: ST style fiber connector(s)					
SCL: SC style fiber connector(s), long haul fiber (40km), on singlemode models					
STL: ST style fiber connector(s), long haul fiber (40km), on singlemode models					
Pre-set for Ring models only					
E0: Pre-set for 0 rings (special order)					
E1: Pre-set for 1 ring (standard order), configured on last 2 ports					
E2: Pre-set for 2 rings (special order), Ring 1 = last 2 ports, Ring 2 = ports 1 & 2.					

Example: RJ-Switch, 5 ports Ethernet Ring switch, with 1 multimode ST fiber port, pre-set for 1 ring: **RJS-5RS-2-ST-E1**

Series	RJS	9RG	CC
RJ-Switch			
Type of Electronics			
9RG: 9 ports, Unmanaged RING Ethernet Switch including 3 gigabit ports			
9MG: 9 ports, Managed Ethernet Switch including 3 gigabit ports			
RJ45 or fiber (FO) ports			
CC: 6 ports RJ45 100 Mbps + 3 gigabit RJ45 ports			
MM: 6 ports RJ45 100 Mbps + 1 port gigabit RJ45 + 2 ports FO multimode gigabit (LC connectors)			
SS: 6 ports RJ45 100 Mbps + 1 port gigabit RJ45 + 2 ports FO multimode gigabit (LC connectors)			

Note: 9RG models have ports 8&9 (FO or gigabit RJ45) pre-set for a ring.



ATEX ZONE 2 RUGGED & IP68 SEALED ETHERNET SWITCH



Outstanding features :

- IP65/68 Sealing
- ATEX Zone 2 II3G ExnAII T4X (EN60079-15 & EN60079-0)
- Plug and Play simplicity
- Ring redundancy
- Operating temperature: -40°F to 170°F (-40°C to +75°C)

Industrial Applications

- Oil & Gas
- Process Control
- Factory Automation

This Ethernet Switch is a combination of rugged packaging with locking device for Zone 2 hazardous location, with fault-tolerant network redundancy.

P/N: RJSPC-EX-5ES1-PLG-CAPS

Note: this part number includes:

- One ATEX Zone 2 IP68 Plug and Play Ethernet switch equipped with caps on Ethernet connectors
- One power plug equipped with anti decoupling nut
- Five Ethernet plugs equipped with anti decoupling spring

P/N: RJSPC-EX-5RS1-PLG-CAPS

Note: this part number includes:

- One ATEX Zone 2 IP68 RING Ethernet switch equipped with caps on Ethernet connectors
- One power plug equipped with anti decoupling nut
- Five Ethernet plugs equipped with anti decoupling spring

Key Features

- Ring Switch Networking Features (managed features available!)
 - Real-Time Ring for ultra-fast fault-tolerant loops
 - Recovery time of 30 ms + 5 ms per hop!
 - Modbus monitoring over Ethernet
 - Ideal for deterministic systems and PLCs
 - Real-time traffic prioritization (QoS and CoS)
 - Assure delivery of real-time data
 - Improve network utilization
 - User settable priority assignments
 - Advanced switch features
 - User configurable port settings
 - Port mirroring for traffic diagnostics
 - Pre-configurable for Plug-And-Play simplicity



- 1 LEDs indicating activity, link status, datarate (10/100 Mbps)
- 2 LED indicating ring status
- 3 5 rugged IP68 RJ Field Ethernet ports
- 4 Real-time ring feature
- 5 IP68 polyester enclosure reinforced with glass fiber
- 6 OK power & ring status
- 7 LEDs indicating power
- 8 Anti-decoupling nut for power plug
- 9 Anti-decoupling spring for ethernet plugs

Description (example for Ring model)

- Waterproof IP68 Rating (NEMA 6)
- Reduced Installation Costs with the patented RJStop® system
- Use any standard RJ45 cordset
- Rugged Enclosure in Polyester reinforced with 30% glass fiber
- Redundant power inputs with surge/spike protection
- Ultra reliable 1,000,000 hours Mean Time Between Failure (MTBF)
- Zone 2 hazardous location (models RJSPC-EX)

Данный компонент на территории Российской Федерации

Вы можете приобрести в компании MosChip.

Для оперативного оформления запроса Вам необходимо перейти по данной ссылке:

<http://moschip.ru/get-element>

Вы можете разместить у нас заказ для любого Вашего проекта, будь то серийное производство или разработка единичного прибора.

В нашем ассортименте представлены ведущие мировые производители активных и пассивных электронных компонентов.

Нашей специализацией является поставка электронной компонентной базы двойного назначения, продукции таких производителей как XILINX, Intel (ex.ALTERA), Vicor, Microchip, Texas Instruments, Analog Devices, Mini-Circuits, Amphenol, Glenair.

Сотрудничество с глобальными дистрибьюторами электронных компонентов, предоставляет возможность заказывать и получать с международных складов практически любой перечень компонентов в оптимальные для Вас сроки.

На всех этапах разработки и производства наши партнеры могут получить квалифицированную поддержку опытных инженеров.

Система менеджмента качества компании отвечает требованиям в соответствии с ГОСТ Р ИСО 9001, ГОСТ РВ 0015-002 и ЭС РД 009

Офис по работе с юридическими лицами:

105318, г.Москва, ул.Щербаковская д.3, офис 1107, 1118, ДЦ «Щербаковский»

Телефон: +7 495 668-12-70 (многоканальный)

Факс: +7 495 668-12-70 (доб.304)

E-mail: info@moschip.ru

Skype отдела продаж:

moschip.ru

moschip.ru_4

moschip.ru_6

moschip.ru_9