



RF Power GaN Transistor

This 14 W asymmetrical Doherty RF power GaN transistor is designed for cellular base station applications requiring very wide instantaneous bandwidth capability covering the frequency range of 3400 to 3600 MHz.

This part is characterized and performance is guaranteed for applications operating in the 3400 to 3600 MHz band. There is no guarantee of performance when this part is used in applications designed outside of these frequencies.

3500 MHz

- Typical Doherty Single-Carrier W-CDMA Performance: $V_{DD} = 48$ Vdc, $I_{DQA} = 80$ mA, $V_{GSB} = -5.0$ Vdc, $P_{out} = 14$ W Avg., Input Signal PAR = 9.9 dB @ 0.01% Probability on CCDF.

Frequency	G_{ps} (dB)	η_D (%)	Output PAR (dB)	ACPR (dBc)
3400 MHz	14.0	43.8	9.6	-34.0
3500 MHz	14.0	41.4	9.7	-34.5
3600 MHz	14.0	42.5	9.6	-32.2

Features

- High terminal impedances for optimal broadband performance
- Advanced high performance in-package Doherty
- Able to withstand extremely high output VSWR and broadband operating conditions

A3G35H100-04SR3

3400–3600 MHz, 14 W AVG., 48 V AIRFAST RF POWER GaN TRANSISTOR

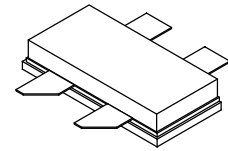

NI-780S-4L

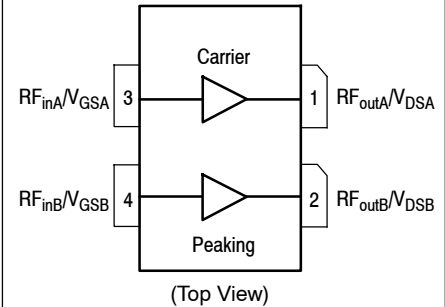

Figure 1. Pin Connections

Table 1. Maximum Ratings

Rating	Symbol	Value	Unit
Drain-Source Voltage	V_{DSS}	125	Vdc
Gate-Source Voltage	V_{GS}	-8, 0	Vdc
Operating Voltage	V_{DD}	0 to +55	Vdc
Maximum Forward Gate Current @ $T_C = 25^\circ\text{C}$	I_{GMAX}	13.4	mA
Storage Temperature Range	T_{stg}	-65 to +150	$^\circ\text{C}$
Case Operating Temperature Range	T_C	-55 to +150	$^\circ\text{C}$
Operating Junction Temperature Range	T_J	-55 to +225	$^\circ\text{C}$
Absolute Maximum Junction Temperature (1)	T_{MAX}	275	$^\circ\text{C}$

Table 2. Thermal Characteristics

Characteristic	Symbol	Value	Unit
Thermal Resistance by Infrared Measurement, Active Die Surface-to-Case Case Temperature 71°C , $P_D = 24.3\text{ W}$	$R_{\theta JC}$ (IR)	2.3 (2)	$^\circ\text{C}/\text{W}$
Thermal Resistance by Finite Element Analysis, Junction-to-Case Case Temperature 90°C , $P_D = 24\text{ W}$	$R_{\theta JC}$ (FEA)	3.88 (3)	$^\circ\text{C}/\text{W}$

Table 3. ESD Protection Characteristics

Test Methodology	Class
Human Body Model (per JS-001-2017)	1C
Charge Device Model (per JS-002-2014)	C2

Table 4. Electrical Characteristics ($T_A = 25^\circ\text{C}$ unless otherwise noted)

Characteristic	Symbol	Min	Typ	Max	Unit
----------------	--------	-----	-----	-----	------

Off Characteristics (4)

Drain-Source Breakdown Voltage ($V_{GS} = -8\text{ Vdc}$, $I_D = 5.4\text{ mAdc}$) ($V_{GS} = -8\text{ Vdc}$, $I_D = 8.04\text{ mAdc}$)	$V_{(BR)DSS}$	150 150	—	—	Vdc
---	---------------	------------	---	---	-----

On Characteristics - Side A, Carrier

Gate Threshold Voltage ($V_{DS} = 10\text{ Vdc}$, $I_D = 5.4\text{ mAdc}$)	$V_{GS(th)}$	-3.8	-3.1	-2.3	Vdc
Gate Quiescent Voltage ($V_{DD} = 48\text{ Vdc}$, $I_{DA} = 80\text{ mAdc}$, Measured in Functional Test)	$V_{GSA(Q)}$	-3.6	-2.9	-2.6	Vdc
Gate-Source Leakage Current ($V_{DS} = 0\text{ Vdc}$, $V_{GS} = -5\text{ Vdc}$)	I_{GSS}	-1.7	—	—	mAdc

On Characteristics - Side B, Peaking

Gate Threshold Voltage ($V_{DS} = 10\text{ Vdc}$, $I_D = 8.04\text{ mAdc}$)	$V_{GS(th)}$	-3.8	-3.2	-2.3	Vdc
Gate-Source Leakage Current ($V_{DS} = 0\text{ Vdc}$, $V_{GS} = -5\text{ Vdc}$)	I_{GSS}	-2.5	—	—	mAdc

1. Functional operation above 225°C has not been characterized and is not implied. Operation at T_{MAX} (275°C) reduces median time to failure by an order of magnitude; operation beyond T_{MAX} could cause permanent damage.
2. Refer to AN1955, *Thermal Measurement Methodology of RF Power Amplifiers*. Go to <http://www.nxp.com/RF> and search for AN1955.
3. $R_{\theta JC}$ (FEA) must be used for purposes related to reliability and limitations on maximum junction temperature. MTTF may be estimated by the expression $MTTF$ (hours) = $10^{[A + B/(T + 273)]}$, where T is the junction temperature in degrees Celsius, $A = -10.3$ and $B = 8260$.
4. Each side of device measured separately.

(continued)

Table 4. Electrical Characteristics ($T_A = 25^\circ\text{C}$ unless otherwise noted) (continued)

Characteristic	Symbol	Min	Typ	Max	Unit
Functional Tests ^(1,2) (In NXP Doherty Test Fixture, 50 ohm system) $V_{DD} = 48\text{ Vdc}$, $I_{DQA} = 80\text{ mA}$, $V_{GSB} = -5.0\text{ Vdc}$, $P_{out} = 14\text{ W Avg.}$, $f = 3600\text{ MHz}$, Single-Carrier W-CDMA, IQ Magnitude Clipping, Input Signal PAR = 9.9 dB @ 0.01% Probability on CCDF. ACPR measured in 3.84 MHz Channel Bandwidth @ $\pm 5\text{ MHz}$ Offset. [See note on correct biasing sequence.]					
Power Gain	G_{ps}	13.0	14.0	15.0	dB
Drain Efficiency	η_D	37.7	42.5	—	%
Output Peak-to-Average Ratio @ 0.01% Probability on CCDF	PAR	8.8	9.6	—	dB
Adjacent Channel Power Ratio	ACPR	—	-32.2	-29.5	dBc

Load Mismatch ⁽²⁾ (In NXP Doherty Test Fixture, 50 ohm system) $I_{DQA} = 80\text{ mA}$, $V_{GSB} = -5.1\text{ Vdc}$, $f = 3500\text{ MHz}$, 12 $\mu\text{sec(ON)}$, 10% Duty Cycle

VSWR 10:1 at 55 Vdc, 158 W Pulsed CW Output Power (3 dB Input Overdrive from 91 W Pulsed CW Rated Power)	No Device Degradation
--	-----------------------

Typical Performance ⁽²⁾ (In NXP Doherty Test Fixture, 50 ohm system) $V_{DD} = 48\text{ Vdc}$, $I_{DQA} = 80\text{ mA}$, $V_{GSB} = -5.1\text{ Vdc}$, 3400–3600 MHz Bandwidth

P_{out} @ 3 dB Compression Point ⁽³⁾	P3dB	—	100	—	W
AM/PM (Maximum value measured at the P3dB compression point across the 3400–3600 MHz bandwidth)	Φ	—	-32	—	°
VBW Resonance Point (IMD Third Order Intermodulation Inflection Point)	VBW_{res}	—	260	—	MHz
Gain Flatness in 200 MHz Bandwidth @ $P_{out} = 14\text{ W Avg.}$	G_F	—	0.31	—	dB
Gain Variation over Temperature (-30°C to +85°C)	ΔG	—	0.011	—	dB/°C
Output Power Variation over Temperature (-30°C to +85°C)	ΔP_{1dB}	—	0.006	—	dB/°C

Table 5. Ordering Information

Device	Tape and Reel Information	Package
A3G35H100-04SR3	R3 Suffix = 250 Units, 32 mm Tape Width, 13-inch Reel	NI-780S-4L

- Part internally input matched.
- Measurements made with device in an asymmetrical Doherty configuration.
- P3dB = $P_{avg} + 7.0\text{ dB}$ where P_{avg} is the average output power measured using an unclipped W-CDMA single-carrier input signal where output PAR is compressed to 7.0 dB @ 0.01% probability on CCDF.

NOTE: Correct Biasing Sequence for GaN Depletion Mode Transistors**Turning the device ON**

- Set V_{GS} to -5 V
- Turn on V_{DS} to nominal supply voltage (48 V)
- Increase V_{GS} until I_{DS} current is attained
- Apply RF input power to desired level

Turning the device OFF

- Turn RF power off
- Reduce V_{GS} down to -5 V
- Reduce V_{DS} down to 0 V (Adequate time must be allowed for V_{DS} to reduce to 0 V to prevent severe damage to device.)
- Turn off V_{GS}

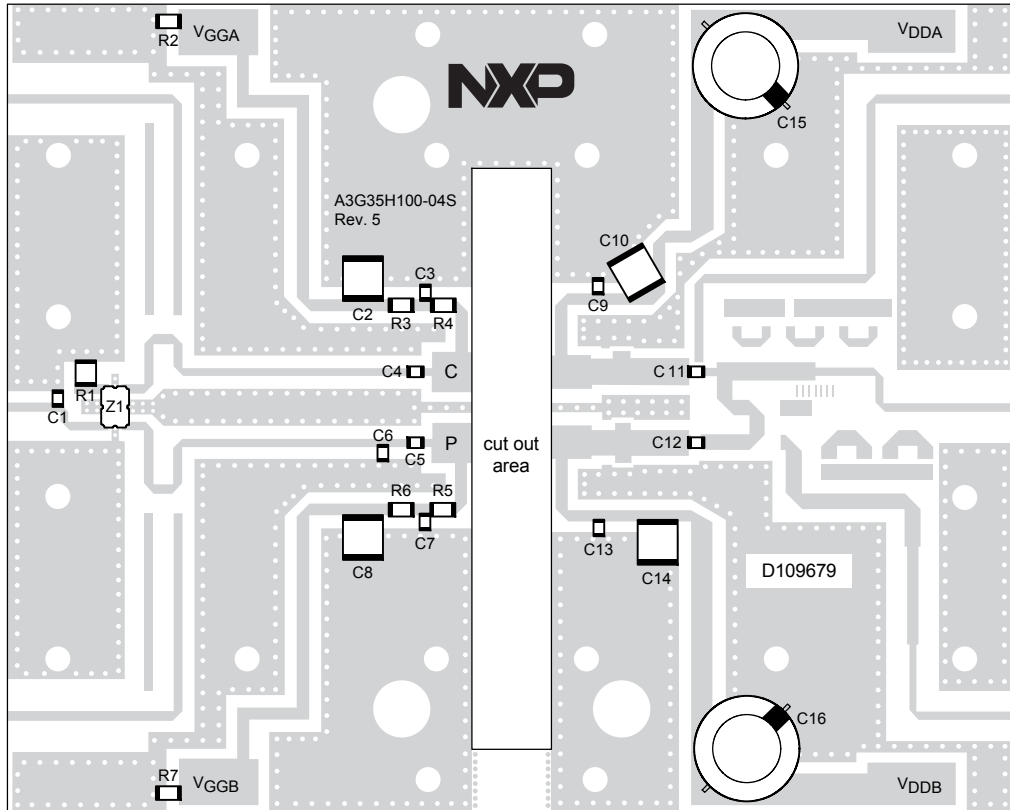

Figure 2. A3G35H100-04SR3 Test Circuit Component Layout

aaa-030282

Table 6. A3G35H100-04SR3 Test Circuit Component Designations and Values

Part	Description	Part Number	Manufacturer
C1, C6	0.1 pF Chip Capacitor	ATC600F0R1BT250XT	ATC
C2, C8, C10, C14	10 μ F Chip Capacitor	C5750X7S2A106M230KB	TDK
C3, C4, C5, C7, C9, C11, C13	5.1 pF Chip Capacitor	ATC600F5R1BT250XT	ATC
C12	4.3 pF Chip Capacitor	ATC600F4R3BT250XT	ATC
C15, C16	220 μ F, 100 V Electrolytic Capacitor	MCGPR100V227M16X26	Multicomp
R1	50 Ω , 10 W Chip Resistor	C10A50Z4	Anaren
R2, R7	51 k Ω , 1/4 W Chip Resistor	CRCW120651K0FKEA	Vishay
R3, R6	3 Ω , 1/4 W Chip Resistor	CRCW12063R00JNEA	Vishay
R4	1.5 Ω , 1/4 W Chip Resistor	RC1206FR-071R5L	Yageo
R5	1 Ω , 1/4 W Chip Resistor	CRCW12061R00FKEA	Vishay
Z1	3300–3800 MHz Band, 90°, 2 dB Hybrid Coupler	X3C35F1-02S	Anaren
PCB	Rogers RO4350B, 0.020", $\epsilon_r = 3.66$	D109679	MTL

TYPICAL CHARACTERISTICS — 3400–3600 MHz

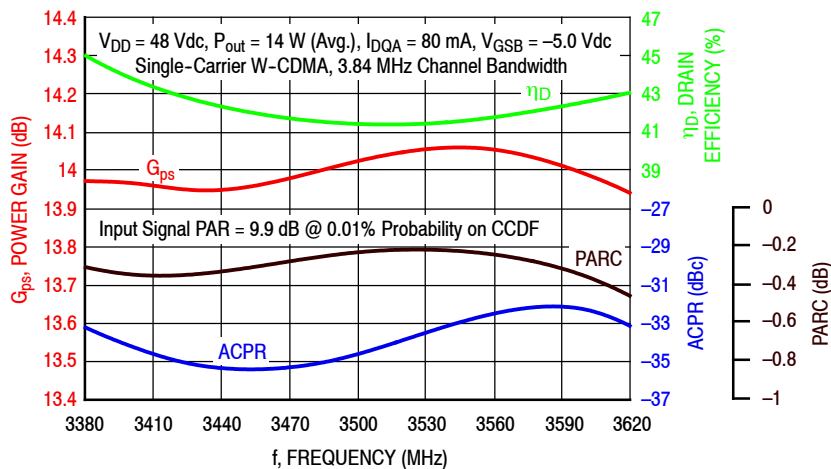

Figure 3. Single-Carrier Output Peak-to-Average Ratio Compression (PARC) Broadband Performance @ $P_{out} = 14$ Watts Avg.

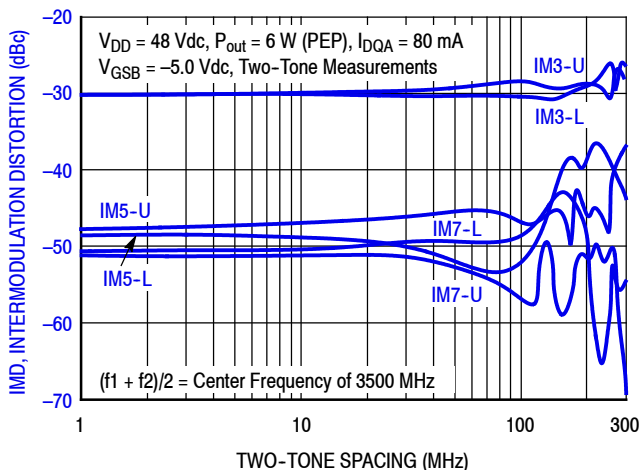

Figure 4. Intermodulation Distortion Products versus Two-Tone Spacing

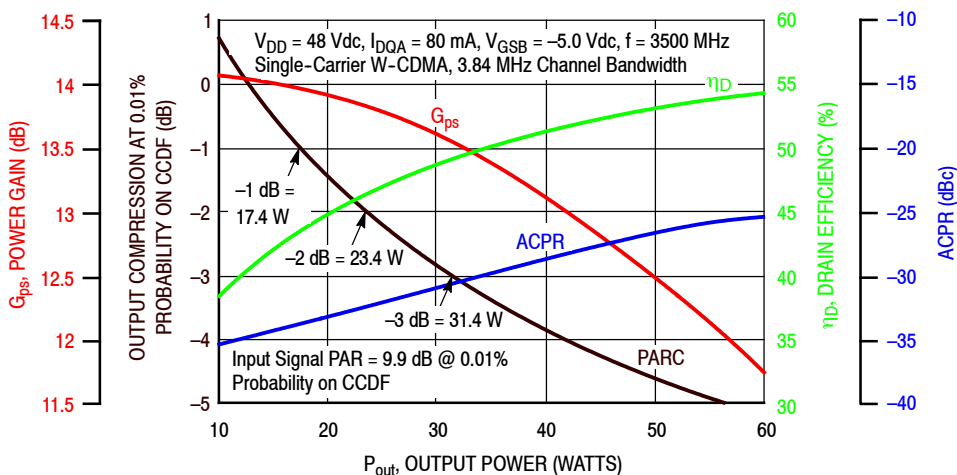

Figure 5. Output Peak-to-Average Ratio Compression (PARC) versus Output Power

TYPICAL CHARACTERISTICS — 3400–3600 MHz

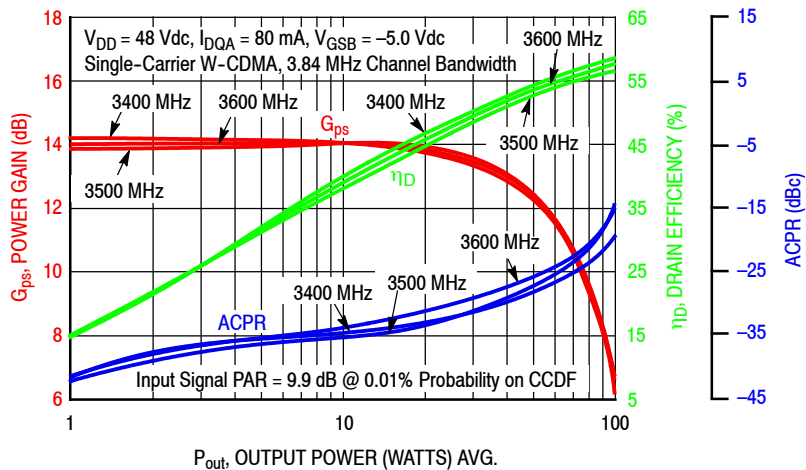

Figure 6. Single-Carrier W-CDMA Power Gain, Drain Efficiency and ACPR versus Output Power

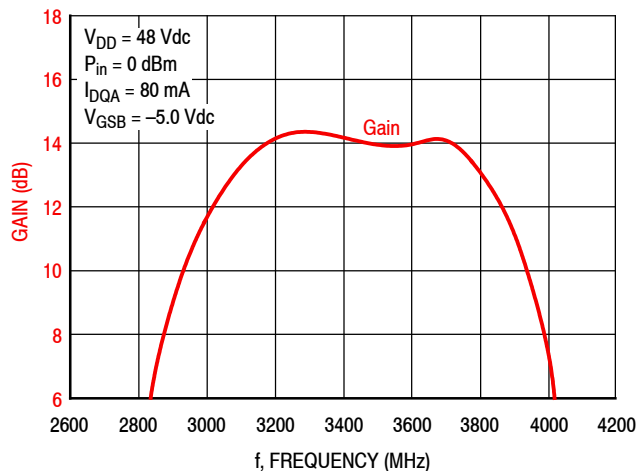
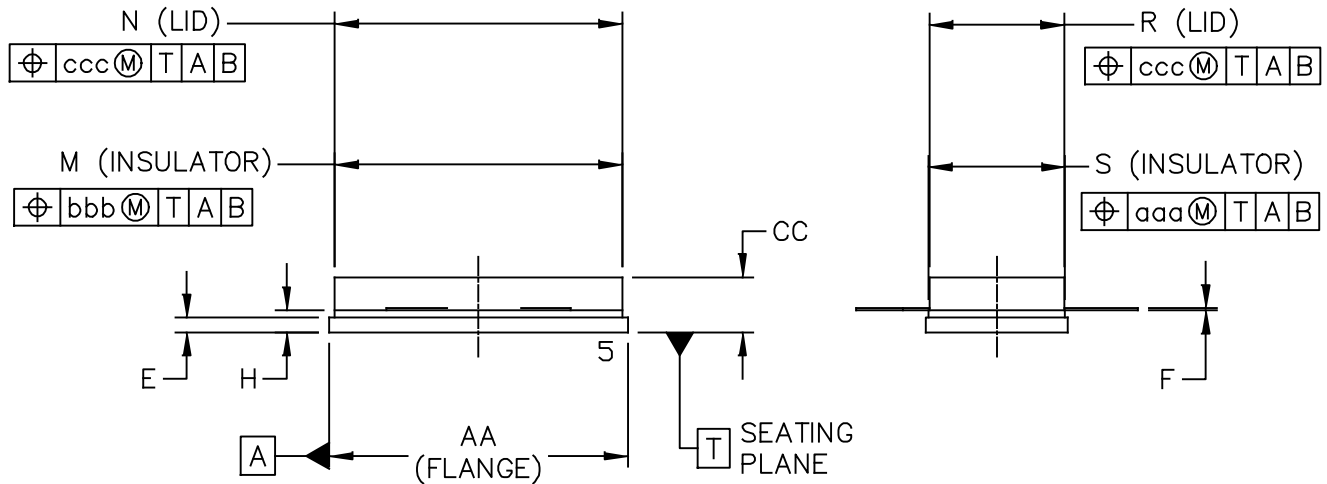
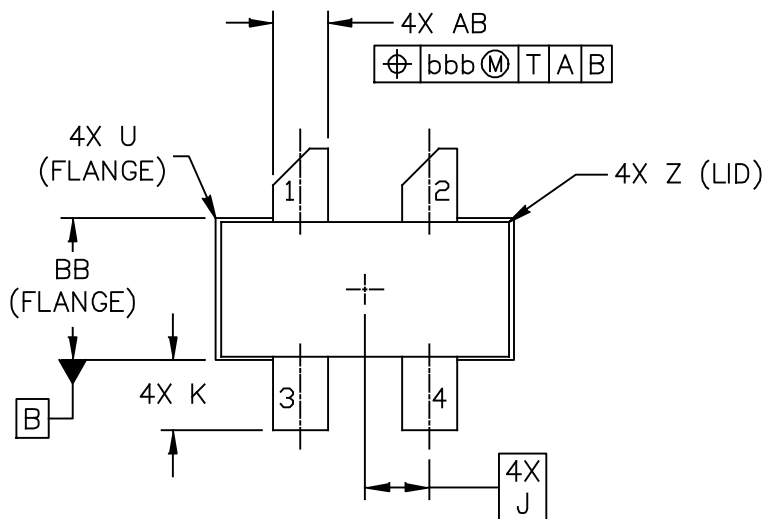

Figure 7. Broadband Frequency Response

PACKAGE DIMENSIONS



© NXP SEMICONDUCTORS N.V. ALL RIGHTS RESERVED	MECHANICAL OUTLINE	PRINT VERSION NOT TO SCALE
TITLE: NI-780S-4L	DOCUMENT NO: 98ASA10718D STANDARD: NON-JEDEC SOT1826-1	REV: C 01 AUG 2016

NOTES:

1. DIMENSIONING AND TOLERANCING PER ANSI Y14.5M-1994.
2. CONTROLLING DIMENSION: INCH.
3. DELETED
4. DIMENSION H IS MEASURED .030 (0.762) AWAY FROM FLANGE TO CLEAR EPOXY FLOW OUT PARALLEL TO DATUM B.

DIM	INCH		MILLIMETER		DIM	INCH		MILLIMETER	
	MIN	MAX	MIN	MAX		MIN	MAX	MIN	MAX
AA	.805	.815	20.45	20.70	U		.040		1.02
BB	.382	.388	9.70	9.86	Z		.030		0.76
CC	.125	.170	3.18	4.32	AB	.145	.155	3.68	- 3.94
E	.035	.045	0.89	1.14					
F	.003	.006	0.08	0.15	aaa		.005		0.127
H	.057	.067	1.45	1.70	bbb		.010		0.254
J	.175 BSC		4.44 BSC		ccc		.015		0.381
K	.170	.210	4.32	5.33					
M	.774	.786	19.61	20.02					
N	.772	.788	19.61	20.02					
R	.365	.375	9.27	9.53					
S	.365	.375	9.27	9.52					
© NXP SEMICONDUCTORS N. V. ALL RIGHTS RESERVED			MECHANICAL OUTLINE			PRINT VERSION NOT TO SCALE			
TITLE: NI-780S-4L					DOCUMENT NO: 98ASA10718D REV: C				
					STANDARD: NON-JEDEC				
					SOT1826-1			01 AUG 2016	

PRODUCT DOCUMENTATION, SOFTWARE AND TOOLS

Refer to the following resources to aid your design process.

Application Notes

- AN1908: Solder Reflow Attach Method for High Power RF Devices in Air Cavity Packages
- AN1955: Thermal Measurement Methodology of RF Power Amplifiers

Software

- .s2p File

Development Tools

- Printed Circuit Boards

To Download Resources Specific to a Given Part Number:

1. Go to <http://www.nxp.com/RF>
2. Search by part number
3. Click part number link
4. Choose the desired resource from the drop down menu

REVISION HISTORY

The following table summarizes revisions to this document.

Revision	Date	Description
0	May 2018	<ul style="list-style-type: none">• Initial release of data sheet

How to Reach Us:

Home Page:
nxp.com

Web Support:
nxp.com/support

Information in this document is provided solely to enable system and software implementers to use NXP products. There are no express or implied copyright licenses granted hereunder to design or fabricate any integrated circuits based on the information in this document. NXP reserves the right to make changes without further notice to any products herein.

NXP makes no warranty, representation, or guarantee regarding the suitability of its products for any particular purpose, nor does NXP assume any liability arising out of the application or use of any product or circuit, and specifically disclaims any and all liability, including without limitation consequential or incidental damages. "Typical" parameters that may be provided in NXP data sheets and/or specifications can and do vary in different applications, and actual performance may vary over time. All operating parameters, including "typicals," must be validated for each customer application by customer's technical experts. NXP does not convey any license under its patent rights nor the rights of others. NXP sells products pursuant to standard terms and conditions of sale, which can be found at the following address: nxp.com/SalesTermsandConditions.

NXP, the NXP logo and Airfast are trademarks of NXP B.V. All other product or service names are the property of their respective owners.

© 2018 NXP B.V.



Данный компонент на территории Российской Федерации

Вы можете приобрести в компании MosChip.

Для оперативного оформления запроса Вам необходимо перейти по данной ссылке:

<http://moschip.ru/get-element>

Вы можете разместить у нас заказ для любого Вашего проекта, будь то серийное производство или разработка единичного прибора.

В нашем ассортименте представлены ведущие мировые производители активных и пассивных электронных компонентов.

Нашей специализацией является поставка электронной компонентной базы двойного назначения, продукции таких производителей как XILINX, Intel (ex.ALTERA), Vicor, Microchip, Texas Instruments, Analog Devices, Mini-Circuits, Amphenol, Glenair.

Сотрудничество с глобальными дистрибьюторами электронных компонентов, предоставляет возможность заказывать и получать с международных складов практически любой перечень компонентов в оптимальные для Вас сроки.

На всех этапах разработки и производства наши партнеры могут получить квалифицированную поддержку опытных инженеров.

Система менеджмента качества компании отвечает требованиям в соответствии с ГОСТ Р ИСО 9001, ГОСТ РВ 0015-002 и ЭС РД 009

Офис по работе с юридическими лицами:

105318, г.Москва, ул.Щербаковская д.3, офис 1107, 1118, ДЦ «Щербаковский»

Телефон: +7 495 668-12-70 (многоканальный)

Факс: +7 495 668-12-70 (доб.304)

E-mail: info@moschip.ru

Skype отдела продаж:

moschip.ru

moschip.ru_4

moschip.ru_6

moschip.ru_9