

74AUP1G98

Low-power configurable multiple function gate

Rev. 8 — 23 September 2015

Product data sheet

1. General description

The 74AUP1G98 provides configurable multiple functions. The output state is determined by eight patterns of 3-bit input. The user can choose the logic functions MUX, AND, OR, NAND, NOR, inverter and buffer. All inputs can be connected to V_{CC} or GND.

This device ensures a very low static and dynamic power consumption across the entire V_{CC} range from 0.8 V to 3.6 V.

This device is fully specified for partial power-down applications using I_{OFF} . The I_{OFF} circuitry disables the output, preventing the damaging backflow current through the device when it is powered down.

The 74AUP1G98 has Schmitt trigger inputs making it capable of transforming slowly changing input signals into sharply defined, jitter-free output signals.

The inputs switch at different points for positive and negative-going signals. The difference between the positive voltage V_{T+} and the negative voltage V_{T-} is defined as the input hysteresis voltage V_H .

2. Features and benefits

- Wide supply voltage range from 0.8 V to 3.6 V
- High noise immunity
- ESD protection:
 - ◆ HBM JESD22-A114F exceeds 5000 V
 - ◆ MM JESD22-A115-A exceeds 200 V
 - ◆ CDM JESD22-C101E exceeds 1000 V
- Low static power consumption; $I_{CC} = 0.9 \mu\text{A}$ (maximum)
- Latch-up performance exceeds 100 mA per JESD 78 Class II
- Inputs accept voltages up to 3.6 V
- Low noise overshoot and undershoot < 10 % of V_{CC}
- I_{OFF} circuitry provides partial power-down mode operation
- Multiple package options
- Specified from $-40 \text{ }^\circ\text{C}$ to $+85 \text{ }^\circ\text{C}$ and $-40 \text{ }^\circ\text{C}$ to $+125 \text{ }^\circ\text{C}$

3. Ordering information

Table 1. Ordering information

| Type number | Package | | | Version |
|-------------|-------------------|--------|---|---------|
| | Temperature range | Name | Description | |
| 74AUP1G98GW | −40 °C to +125 °C | SC-88 | plastic surface-mounted package; 6 leads | SOT363 |
| 74AUP1G98GM | −40 °C to +125 °C | XSON6 | plastic extremely thin small outline package; no leads; 6 terminals; body 1 × 1.45 × 0.5 mm | SOT886 |
| 74AUP1G98GF | −40 °C to +125 °C | XSON6 | plastic extremely thin small outline package; no leads; 6 terminals; body 1 × 1 × 0.5 mm | SOT891 |
| 74AUP1G98GN | −40 °C to +125 °C | XSON6 | extremely thin small outline package; no leads; 6 terminals; body 0.9 × 1.0 × 0.35 mm | SOT1115 |
| 74AUP1G98GS | −40 °C to +125 °C | XSON6 | extremely thin small outline package; no leads; 6 terminals; body 1.0 × 1.0 × 0.35 mm | SOT1202 |
| 74AUP1G98GX | −40 °C to +125 °C | X2SON6 | plastic thermal extremely thin small outline package; no leads; 6 terminals; body 1 × 0.8 × 0.35 mm | SOT1255 |

4. Marking

Table 2. Marking

| Type number | Marking code ^[1] |
|-------------|-----------------------------|
| 74AUP1G98GW | a9 |
| 74AUP1G98GM | a9 |
| 74AUP1G98GF | a9 |
| 74AUP1G98GN | a9 |
| 74AUP1G98GS | a9 |
| 74AUP1G98GX | a9 |

[1] The pin 1 indicator is located on the lower left corner of the device, below the marking code.

5. Functional diagram

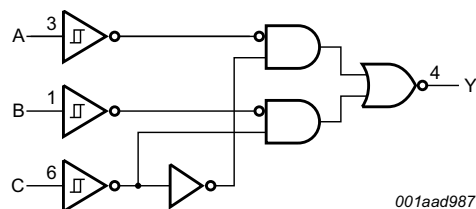

Fig 1. Logic diagram

6. Pinning information

6.1 Pinning

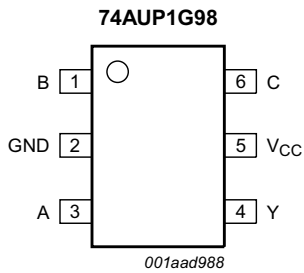

Fig 2. Pin configuration SOT363

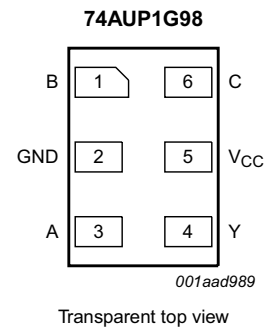

Fig 3. Pin configuration SOT886

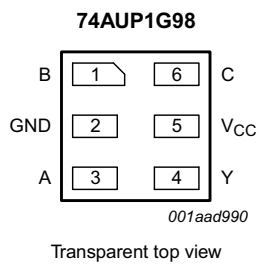

Fig 4. Pin configuration SOT891, SOT1115 and SOT1202

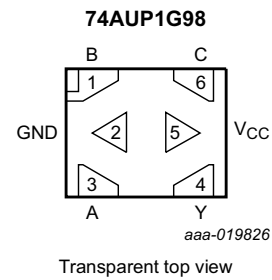

Fig 5. Pin configuration SOT1255 (X2SON6)

6.2 Pin description

Table 3. Pin description

| Symbol | Pin | Description |
|-----------------|-----|----------------|
| B | 1 | data input |
| GND | 2 | ground (0 V) |
| A | 3 | data input |
| Y | 4 | data output |
| V _{CC} | 5 | supply voltage |
| C | 6 | data input |

7. Functional description

Table 4. Function table^[1]

| Input | | | Output |
|-------|---|---|--------|
| C | B | A | Y |
| L | L | L | H |
| L | L | H | H |
| L | H | L | L |
| L | H | H | L |
| H | L | L | H |
| H | L | H | L |
| H | H | L | H |
| H | H | H | L |

[1] H = HIGH voltage level;
L = LOW voltage level.

7.1 Logic configurations

Table 5. Function selection table

| Logic function | Figure |
|--------------------------------------|-------------------------------|
| 2-input MUX with inverted output | see Figure 6 |
| 2-input NAND | see Figure 7 |
| 2-input NOR with one input inverted | see Figure 8 |
| 2-input AND with one input inverted | see Figure 8 |
| 2-input NAND with one input inverted | see Figure 9 |
| 2-input OR with one input inverted | see Figure 9 |
| 2-input NOR | see Figure 10 |
| Buffer | see Figure 11 |
| Inverter | see Figure 12 |

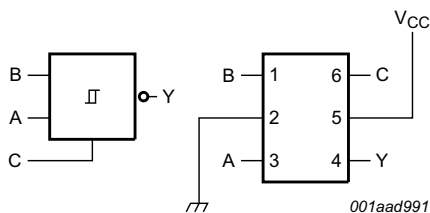

Fig 6. 2-input MUX with inverted output

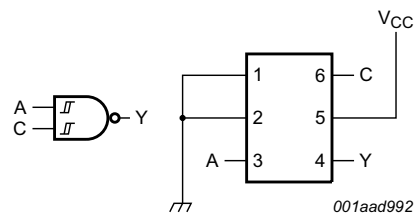

Fig 7. 2-input NAND gate

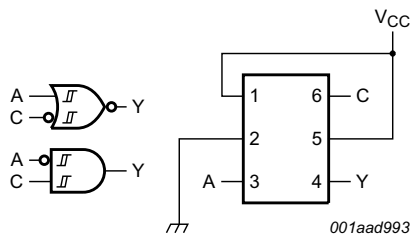

Fig 8. 2-input AND gate with input A inverted or 2-input NOR gate with inverted C input

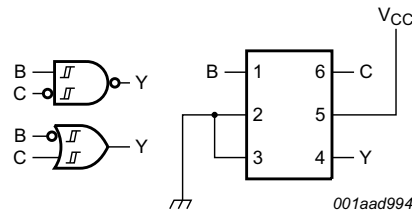

Fig 9. 2-input OR gate with input B inverted or 2-input NAND gate with input C inverted

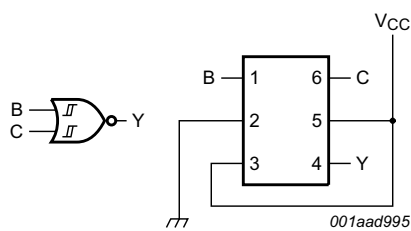

Fig 10. 2-input NOR gate

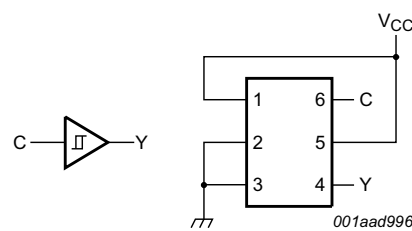

Fig 11. Buffer

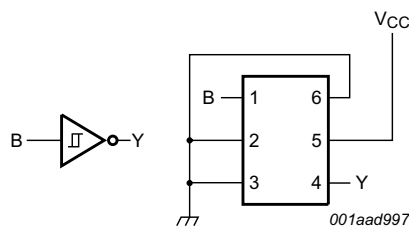

Fig 12. Inverter

8. Limiting values

Table 6. Limiting values

In accordance with the Absolute Maximum Rating System (IEC 60134). Voltages are referenced to GND (ground = 0 V).

| Symbol | Parameter | Conditions | Min | Max | Unit |
|----------|-------------------------|-------------------------------------|------|------|------|
| V_{CC} | supply voltage | | -0.5 | +4.6 | V |
| I_{IK} | input clamping current | $V_I < 0$ V | -50 | - | mA |
| V_I | input voltage | [1] | -0.5 | +4.6 | V |
| I_{OK} | output clamping current | $V_O < 0$ V | -50 | - | mA |
| V_O | output voltage | Active mode and Power-down mode [1] | -0.5 | +4.6 | V |
| I_O | output current | $V_O = 0$ V to V_{CC} | - | ±20 | mA |
| I_{CC} | supply current | | - | 50 | mA |

Table 6. Limiting values ...continued

In accordance with the Absolute Maximum Rating System (IEC 60134). Voltages are referenced to GND (ground = 0 V).

| Symbol | Parameter | Conditions | Min | Max | Unit |
|------------------|-------------------------|--|-----|------|------|
| I_{GND} | ground current | | -50 | - | mA |
| T_{stg} | storage temperature | | -65 | +150 | °C |
| P_{tot} | total power dissipation | $T_{\text{amb}} = -40\text{ °C to }+125\text{ °C}$ [2] | - | 250 | mW |

[1] The minimum input and output voltage ratings may be exceeded if the input and output current ratings are observed.

[2] For SC-88 packages: above 87.5 °C the value of P_{tot} derates linearly with 4.0 mW/K.

For X2SON6 and XSON6 packages: above 118 °C the value of P_{tot} derates linearly with 7.8 mW/K.

9. Recommended operating conditions

Table 7. Recommended operating conditions

| Symbol | Parameter | Conditions | Min | Max | Unit |
|------------------|---------------------|---|-----|-----------------|------|
| V_{CC} | supply voltage | | 0.8 | 3.6 | V |
| V_{I} | input voltage | | 0 | 3.6 | V |
| V_{O} | output voltage | Active mode | 0 | V_{CC} | V |
| | | Power-down mode; $V_{\text{CC}} = 0\text{ V}$ | 0 | 3.6 | V |
| T_{amb} | ambient temperature | | -40 | +125 | °C |

10. Static characteristics

Table 8. Static characteristics

At recommended operating conditions; voltages are referenced to GND (ground = 0 V).

| Symbol | Parameter | Conditions | Min | Typ | Max | Unit |
|---|---------------------------|--|-----------------------|-----|--------------------|------|
| $T_{\text{amb}} = 25\text{ °C}$ | | | | | | |
| V_{OH} | HIGH-level output voltage | $V_{\text{I}} = V_{\text{T+}}$ or $V_{\text{T-}}$ | | | | |
| | | $I_{\text{O}} = -20\text{ }\mu\text{A}$; $V_{\text{CC}} = 0.8\text{ V to }3.6\text{ V}$ | $V_{\text{CC}} - 0.1$ | - | - | V |
| | | $I_{\text{O}} = -1.1\text{ mA}$; $V_{\text{CC}} = 1.1\text{ V}$ | $0.75V_{\text{CC}}$ | - | - | V |
| | | $I_{\text{O}} = -1.7\text{ mA}$; $V_{\text{CC}} = 1.4\text{ V}$ | 1.11 | - | - | V |
| | | $I_{\text{O}} = -1.9\text{ mA}$; $V_{\text{CC}} = 1.65\text{ V}$ | 1.32 | - | - | V |
| | | $I_{\text{O}} = -2.3\text{ mA}$; $V_{\text{CC}} = 2.3\text{ V}$ | 2.05 | - | - | V |
| | | $I_{\text{O}} = -3.1\text{ mA}$; $V_{\text{CC}} = 2.3\text{ V}$ | 1.9 | - | - | V |
| | | $I_{\text{O}} = -2.7\text{ mA}$; $V_{\text{CC}} = 3.0\text{ V}$ | 2.72 | - | - | V |
| V_{OL} | LOW-level output voltage | $V_{\text{I}} = V_{\text{T+}}$ or $V_{\text{T-}}$ | | | | |
| | | $I_{\text{O}} = 20\text{ }\mu\text{A}$; $V_{\text{CC}} = 0.8\text{ V to }3.6\text{ V}$ | - | - | 0.1 | V |
| | | $I_{\text{O}} = 1.1\text{ mA}$; $V_{\text{CC}} = 1.1\text{ V}$ | - | - | $0.3V_{\text{CC}}$ | V |
| | | $I_{\text{O}} = 1.7\text{ mA}$; $V_{\text{CC}} = 1.4\text{ V}$ | - | - | 0.31 | V |
| | | $I_{\text{O}} = 1.9\text{ mA}$; $V_{\text{CC}} = 1.65\text{ V}$ | - | - | 0.31 | V |
| | | $I_{\text{O}} = 2.3\text{ mA}$; $V_{\text{CC}} = 2.3\text{ V}$ | - | - | 0.31 | V |
| | | $I_{\text{O}} = 3.1\text{ mA}$; $V_{\text{CC}} = 2.3\text{ V}$ | - | - | 0.44 | V |
| | | $I_{\text{O}} = 2.7\text{ mA}$; $V_{\text{CC}} = 3.0\text{ V}$ | - | - | 0.31 | V |
| $I_{\text{O}} = 4.0\text{ mA}$; $V_{\text{CC}} = 3.0\text{ V}$ | - | - | 0.44 | V | | |

Table 8. Static characteristics ...continued

At recommended operating conditions; voltages are referenced to GND (ground = 0 V).

| Symbol | Parameter | Conditions | Min | Typ | Max | Unit |
|--|---|---|----------------|------|-------------|---------------|
| I_I | input leakage current | $V_I = \text{GND to } 3.6 \text{ V}; V_{CC} = 0 \text{ V to } 3.6 \text{ V}$ | - | - | ± 0.1 | μA |
| I_{OFF} | power-off leakage current | $V_I \text{ or } V_O = 0 \text{ V to } 3.6 \text{ V}; V_{CC} = 0 \text{ V}$ | - | - | ± 0.2 | μA |
| ΔI_{OFF} | additional power-off leakage current | $V_I \text{ or } V_O = 0 \text{ V to } 3.6 \text{ V}; V_{CC} = 0 \text{ V to } 0.2 \text{ V}$ | - | - | ± 0.2 | μA |
| I_{CC} | supply current | $V_I = \text{GND or } V_{CC}; I_O = 0 \text{ A}; V_{CC} = 0.8 \text{ V to } 3.6 \text{ V}$ | - | - | 0.5 | μA |
| ΔI_{CC} | additional supply current | $V_I = V_{CC} - 0.6 \text{ V}; I_O = 0 \text{ A}; V_{CC} = 3.3 \text{ V}$ [1] | - | - | 40 | μA |
| C_I | input capacitance | $V_{CC} = 0 \text{ V to } 3.6 \text{ V}; V_I = \text{GND or } V_{CC}$ | - | 1.1 | - | pF |
| C_O | output capacitance | $V_O = \text{GND}; V_{CC} = 0 \text{ V}$ | - | 1.7 | - | pF |
| $T_{\text{amb}} = -40 \text{ }^\circ\text{C to } +85 \text{ }^\circ\text{C}$ | | | | | | |
| V_{OH} | HIGH-level output voltage | $V_I = V_{T+} \text{ or } V_{T-}$ | | | | |
| | | $I_O = -20 \mu\text{A}; V_{CC} = 0.8 \text{ V to } 3.6 \text{ V}$ | $V_{CC} - 0.1$ | - | - | V |
| | | $I_O = -1.1 \text{ mA}; V_{CC} = 1.1 \text{ V}$ | $0.7V_{CC}$ | - | - | V |
| | | $I_O = -1.7 \text{ mA}; V_{CC} = 1.4 \text{ V}$ | 1.03 | - | - | V |
| | | $I_O = -1.9 \text{ mA}; V_{CC} = 1.65 \text{ V}$ | 1.30 | - | - | V |
| | | $I_O = -2.3 \text{ mA}; V_{CC} = 2.3 \text{ V}$ | 1.97 | - | - | V |
| | | $I_O = -3.1 \text{ mA}; V_{CC} = 2.3 \text{ V}$ | 1.85 | - | - | V |
| | | $I_O = -2.7 \text{ mA}; V_{CC} = 3.0 \text{ V}$ | 2.67 | - | - | V |
| | $I_O = -4.0 \text{ mA}; V_{CC} = 3.0 \text{ V}$ | 2.55 | - | - | V | |
| V_{OL} | LOW-level output voltage | $V_I = V_{T+} \text{ or } V_{T-}$ | | | | |
| | | $I_O = 20 \mu\text{A}; V_{CC} = 0.8 \text{ V to } 3.6 \text{ V}$ | - | - | 0.1 | V |
| | | $I_O = 1.1 \text{ mA}; V_{CC} = 1.1 \text{ V}$ | - | - | $0.3V_{CC}$ | V |
| | | $I_O = 1.7 \text{ mA}; V_{CC} = 1.4 \text{ V}$ | - | - | 0.37 | V |
| | | $I_O = 1.9 \text{ mA}; V_{CC} = 1.65 \text{ V}$ | - | - | 0.35 | V |
| | | $I_O = 2.3 \text{ mA}; V_{CC} = 2.3 \text{ V}$ | - | - | 0.33 | V |
| | | $I_O = 3.1 \text{ mA}; V_{CC} = 2.3 \text{ V}$ | - | - | 0.45 | V |
| | | $I_O = 2.7 \text{ mA}; V_{CC} = 3.0 \text{ V}$ | - | - | 0.33 | V |
| | $I_O = 4.0 \text{ mA}; V_{CC} = 3.0 \text{ V}$ | - | - | 0.45 | V | |
| I_I | input leakage current | $V_I = \text{GND to } 3.6 \text{ V}; V_{CC} = 0 \text{ V to } 3.6 \text{ V}$ | - | - | ± 0.5 | μA |
| I_{OFF} | power-off leakage current | $V_I \text{ or } V_O = 0 \text{ V to } 3.6 \text{ V}; V_{CC} = 0 \text{ V}$ | - | - | ± 0.5 | μA |
| ΔI_{OFF} | additional power-off leakage current | $V_I \text{ or } V_O = 0 \text{ V to } 3.6 \text{ V}; V_{CC} = 0 \text{ V to } 0.2 \text{ V}$ | - | - | ± 0.6 | μA |
| I_{CC} | supply current | $V_I = \text{GND or } V_{CC}; I_O = 0 \text{ A}; V_{CC} = 0.8 \text{ V to } 3.6 \text{ V}$ | - | - | 0.9 | μA |
| ΔI_{CC} | additional supply current | $V_I = V_{CC} - 0.6 \text{ V}; I_O = 0 \text{ A}; V_{CC} = 3.3 \text{ V}$ [1] | - | - | 50 | μA |

Table 8. Static characteristics ...continued

At recommended operating conditions; voltages are referenced to GND (ground = 0 V).

| Symbol | Parameter | Conditions | Min | Typ | Max | Unit |
|--|--------------------------------------|--|------------------------|-----|---------------------|------|
| T_{amb} = -40 °C to +125 °C | | | | | | |
| V _{OH} | HIGH-level output voltage | V _I = V _{T+} or V _{T-} | | | | |
| | | I _O = -20 μA; V _{CC} = 0.8 V to 3.6 V | V _{CC} - 0.11 | - | - | V |
| | | I _O = -1.1 mA; V _{CC} = 1.1 V | 0.6V _{CC} | - | - | V |
| | | I _O = -1.7 mA; V _{CC} = 1.4 V | 0.93 | - | - | V |
| | | I _O = -1.9 mA; V _{CC} = 1.65 V | 1.17 | - | - | V |
| | | I _O = -2.3 mA; V _{CC} = 2.3 V | 1.77 | - | - | V |
| | | I _O = -3.1 mA; V _{CC} = 2.3 V | 1.67 | - | - | V |
| | | I _O = -2.7 mA; V _{CC} = 3.0 V | 2.40 | - | - | V |
| | | I _O = -4.0 mA; V _{CC} = 3.0 V | 2.30 | - | - | V |
| V _{OL} | LOW-level output voltage | V _I = V _{T+} or V _{T-} | | | | |
| | | I _O = 20 μA; V _{CC} = 0.8 V to 3.6 V | - | - | 0.11 | V |
| | | I _O = 1.1 mA; V _{CC} = 1.1 V | - | - | 0.33V _{CC} | V |
| | | I _O = 1.7 mA; V _{CC} = 1.4 V | - | - | 0.41 | V |
| | | I _O = 1.9 mA; V _{CC} = 1.65 V | - | - | 0.39 | V |
| | | I _O = 2.3 mA; V _{CC} = 2.3 V | - | - | 0.36 | V |
| | | I _O = 3.1 mA; V _{CC} = 2.3 V | - | - | 0.50 | V |
| | | I _O = 2.7 mA; V _{CC} = 3.0 V | - | - | 0.36 | V |
| | | I _O = 4.0 mA; V _{CC} = 3.0 V | - | - | 0.50 | V |
| I _I | input leakage current | V _I = GND to 3.6 V; V _{CC} = 0 V to 3.6 V | - | - | ±0.75 | μA |
| I _{OFF} | power-off leakage current | V _I or V _O = 0 V to 3.6 V; V _{CC} = 0 V | - | - | ±0.75 | μA |
| ΔI _{OFF} | additional power-off leakage current | V _I or V _O = 0 V to 3.6 V; V _{CC} = 0 V to 0.2 V | - | - | ±0.75 | μA |
| I _{CC} | supply current | V _I = GND or V _{CC} ; I _O = 0 A; V _{CC} = 0.8 V to 3.6 V | - | - | 1.4 | μA |
| ΔI _{CC} | additional supply current | V _I = V _{CC} - 0.6 V; I _O = 0 A; V _{CC} = 3.3 V | [1] | - | 75 | μA |

[1] One input at V_{CC} - 0.6 V, other input at V_{CC} or GND.

11. Dynamic characteristics

Table 9. Dynamic characteristics

Voltages are referenced to GND (ground = 0 V); for test circuit see [Figure 14](#).

| Symbol | Parameter | Conditions | T _{amb} = 25 °C | | | T _{amb} = -40 °C to +125 °C | | | Unit |
|------------------------------|-------------------|--|--------------------------|--------------------|------|--------------------------------------|-------------|--------------|------|
| | | | Min | Typ ^[1] | Max | Min | Max (85 °C) | Max (125 °C) | |
| C_L = 5 pF | | | | | | | | | |
| t _{pd} | propagation delay | A, B, C to Y; see Figure 13 ^[2] | | | | | | | |
| | | V _{CC} = 0.8 V | - | 23.3 | - | - | - | - | ns |
| | | V _{CC} = 1.1 V to 1.3 V | 2.9 | 6.7 | 12.9 | 2.7 | 13.2 | 13.4 | ns |
| | | V _{CC} = 1.4 V to 1.6 V | 2.4 | 4.8 | 7.7 | 2.4 | 8.3 | 8.7 | ns |
| | | V _{CC} = 1.65 V to 1.95 V | 2.2 | 4.0 | 6.3 | 1.9 | 7.0 | 7.4 | ns |
| | | V _{CC} = 2.3 V to 2.7 V | 2.0 | 3.2 | 4.6 | 1.8 | 5.2 | 5.4 | ns |
| | | V _{CC} = 3.0 V to 3.6 V | 1.9 | 2.9 | 4.0 | 1.6 | 4.2 | 4.4 | ns |
| C_L = 10 pF | | | | | | | | | |
| t _{pd} | propagation delay | A, B, C to Y; see Figure 13 ^[2] | | | | | | | |
| | | V _{CC} = 0.8 V | - | 27.1 | - | - | - | - | ns |
| | | V _{CC} = 1.1 V to 1.3 V | 3.3 | 7.6 | 14.5 | 3.0 | 15.1 | 15.3 | ns |
| | | V _{CC} = 1.4 V to 1.6 V | 2.7 | 5.4 | 8.8 | 2.8 | 9.5 | 9.9 | ns |
| | | V _{CC} = 1.65 V to 1.95 V | 2.5 | 4.6 | 7.2 | 2.3 | 8.0 | 8.4 | ns |
| | | V _{CC} = 2.3 V to 2.7 V | 2.4 | 3.8 | 5.3 | 2.2 | 5.9 | 6.2 | ns |
| | | V _{CC} = 3.0 V to 3.6 V | 2.3 | 3.5 | 4.7 | 2.0 | 4.9 | 5.2 | ns |
| C_L = 15 pF | | | | | | | | | |
| t _{pd} | propagation delay | A, B, C to Y; see Figure 13 ^[2] | | | | | | | |
| | | V _{CC} = 0.8 V | - | 30.6 | - | - | - | - | ns |
| | | V _{CC} = 1.1 V to 1.3 V | 3.6 | 8.4 | 16.1 | 3.3 | 16.9 | 17.2 | ns |
| | | V _{CC} = 1.4 V to 1.6 V | 3.0 | 6.0 | 9.7 | 3.1 | 10.5 | 11.0 | ns |
| | | V _{CC} = 1.65 V to 1.95 V | 2.8 | 5.1 | 7.9 | 2.5 | 8.9 | 9.3 | ns |
| | | V _{CC} = 2.3 V to 2.7 V | 2.7 | 4.2 | 5.9 | 2.5 | 6.6 | 7.0 | ns |
| | | V _{CC} = 3.0 V to 3.6 V | 2.5 | 3.9 | 5.2 | 2.2 | 5.5 | 5.8 | ns |

Table 9. Dynamic characteristics ...continued

Voltages are referenced to GND (ground = 0 V); for test circuit see [Figure 14](#).

| Symbol | Parameter | Conditions | T _{amb} = 25 °C | | | T _{amb} = -40 °C to +125 °C | | | Unit |
|---|-------------------------------|--|--------------------------|--------------------|------|--------------------------------------|-------------|--------------|------|
| | | | Min | Typ ^[1] | Max | Min | Max (85 °C) | Max (125 °C) | |
| C_L = 30 pF | | | | | | | | | |
| t _{pd} | propagation delay | A, B, C to Y; see Figure 13 ^[2] | | | | | | | |
| | | V _{CC} = 0.8 V | - | 38.7 | - | - | - | - | ns |
| | | V _{CC} = 1.1 V to 1.3 V | 4.5 | 10.7 | 21.1 | 4.1 | 22.0 | 22.4 | ns |
| | | V _{CC} = 1.4 V to 1.6 V | 3.8 | 7.6 | 12.3 | 3.8 | 13.5 | 14.2 | ns |
| | | V _{CC} = 1.65 V to 1.95 V | 3.5 | 6.3 | 10.1 | 3.1 | 11.3 | 11.9 | ns |
| | | V _{CC} = 2.3 V to 2.7 V | 3.4 | 5.3 | 7.5 | 3.2 | 8.4 | 8.9 | ns |
| | | V _{CC} = 3.0 V to 3.6 V | 3.2 | 5.0 | 6.7 | 2.9 | 7.1 | 7.5 | ns |
| C_L = 5 pF, 10 pF, 15 pF and 30 pF | | | | | | | | | |
| C _{PD} | power dissipation capacitance | f _i = 1 MHz; V _I = GND to V _{CC} ^[3] | | | | | | | |
| | | V _{CC} = 0.8 V | - | 2.7 | - | - | - | - | pF |
| | | V _{CC} = 1.1 V to 1.3 V | - | 2.9 | - | - | - | - | pF |
| | | V _{CC} = 1.4 V to 1.6 V | - | 3.0 | - | - | - | - | pF |
| | | V _{CC} = 1.65 V to 1.95 V | - | 3.2 | - | - | - | - | pF |
| | | V _{CC} = 2.3 V to 2.7 V | - | 3.8 | - | - | - | - | pF |
| | | V _{CC} = 3.0 V to 3.6 V | - | 4.4 | - | - | - | - | pF |

[1] All typical values are measured at nominal V_{CC}.

[2] t_{pd} is the same as t_{PLH} and t_{PHL}.

[3] C_{PD} is used to determine the dynamic power dissipation (P_D in μW).

$$P_D = C_{PD} \times V_{CC}^2 \times f_i \times N + \Sigma(C_L \times V_{CC}^2 \times f_o) \text{ where:}$$

f_i = input frequency in MHz;

f_o = output frequency in MHz;

C_L = output load capacitance in pF;

V_{CC} = supply voltage in V;

N = number of inputs switching;

Σ(C_L × V_{CC}² × f_o) = sum of the outputs.

12. Waveforms

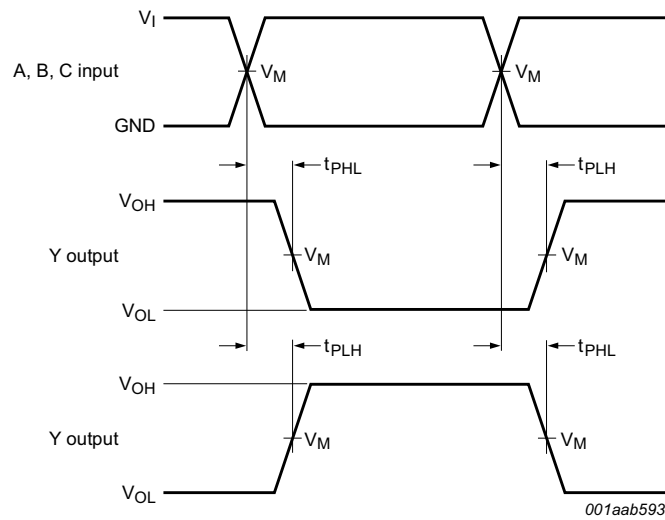

Measurement points are given in [Table 10](#).

V_{OL} and V_{OH} are typical output voltage levels that occur with the output load.

Fig 13. Input A, B and C to output Y propagation delay times.

Table 10. Measurement points

| Supply voltage | Output | Input | | |
|----------------|-------------|-------------|----------|---------------|
| V_{CC} | V_M | V_M | V_I | $t_r = t_f$ |
| 0.8 V to 3.6 V | $0.5V_{CC}$ | $0.5V_{CC}$ | V_{CC} | ≤ 3.0 ns |

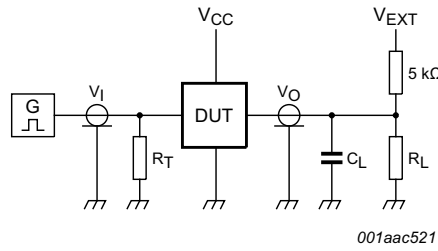

Test data is given in [Table 11](#).

Definitions for test circuit:

R_L = Load resistance.

C_L = Load capacitance including jig and probe capacitance.

R_T = Termination resistance should be equal to the output impedance Z_o of the pulse generator.

V_{EXT} = External voltage for measuring switching times.

Fig 14. Test circuit for measuring switching times

Table 11. Test data

| Supply voltage | Load | | V_{EXT} | | |
|----------------|------------------------------|--------------|-----------------------|-----------------------|-----------------------|
| V_{CC} | C_L | R_L [1] | t_{PLH} , t_{PHL} | t_{PZH} , t_{PHZ} | t_{PZL} , t_{PLZ} |
| 0.8 V to 3.6 V | 5 pF, 10 pF, 15 pF and 30 pF | 5 kΩ or 1 MΩ | open | GND | $2V_{CC}$ |

[1] For measuring enable and disable times $R_L = 5\text{ k}\Omega$, for measuring propagation delays, setup and hold times and pulse width $R_L = 1\text{ M}\Omega$.

13. Transfer characteristics

Table 12. Transfer characteristics

Voltages are referenced to GND (ground = 0 V; for test circuit see [Figure 14](#)).

| Symbol | Parameter | Conditions | $T_{amb} = 25\text{ }^\circ\text{C}$ | | | $T_{amb} = -40\text{ }^\circ\text{C to } +125\text{ }^\circ\text{C}$ | | | Unit |
|----------|----------------------------------|---|--------------------------------------|------|------|--|-------------|--------------|------|
| | | | Min | Typ | Max | Min | Max (85 °C) | Max (125 °C) | |
| V_{T+} | positive-going threshold voltage | see Figure 15 and Figure 16 | | | | | | | |
| | | $V_{CC} = 0.8\text{ V}$ | 0.30 | - | 0.60 | 0.30 | 0.60 | 0.62 | V |
| | | $V_{CC} = 1.1\text{ V}$ | 0.53 | - | 0.90 | 0.53 | 0.90 | 0.92 | V |
| | | $V_{CC} = 1.4\text{ V}$ | 0.74 | - | 1.11 | 0.74 | 1.11 | 1.13 | V |
| | | $V_{CC} = 1.65\text{ V}$ | 0.91 | - | 1.29 | 0.91 | 1.29 | 1.31 | V |
| | | $V_{CC} = 2.3\text{ V}$ | 1.37 | - | 1.77 | 1.37 | 1.77 | 1.80 | V |
| V_{T-} | negative-going threshold voltage | see Figure 15 and Figure 16 | | | | | | | |
| | | $V_{CC} = 0.8\text{ V}$ | 0.10 | - | 0.60 | 0.10 | 0.60 | 0.60 | V |
| | | $V_{CC} = 1.1\text{ V}$ | 0.26 | - | 0.65 | 0.26 | 0.65 | 0.65 | V |
| | | $V_{CC} = 1.4\text{ V}$ | 0.39 | - | 0.75 | 0.39 | 0.75 | 0.75 | V |
| | | $V_{CC} = 1.65\text{ V}$ | 0.47 | - | 0.84 | 0.47 | 0.84 | 0.84 | V |
| | | $V_{CC} = 2.3\text{ V}$ | 0.69 | - | 1.04 | 0.69 | 1.04 | 1.04 | V |
| | $V_{CC} = 3.0\text{ V}$ | 0.88 | - | 1.24 | 0.88 | 1.24 | 1.24 | V | |

Table 12. Transfer characteristics ...continued

Voltages are referenced to GND (ground = 0 V; for test circuit see [Figure 14](#)).

| Symbol | Parameter | Conditions | T _{amb} = 25 °C | | | T _{amb} = -40 °C to +125 °C | | | Unit |
|----------------|--------------------|---|--------------------------|-----|------|--------------------------------------|-------------|--------------|------|
| | | | Min | Typ | Max | Min | Max (85 °C) | Max (125 °C) | |
| V _H | hysteresis voltage | (V _{T+} - V _{T-}); see Figure 15 , Figure 16 , Figure 17 and Figure 18 | | | | | | | |
| | | V _{CC} = 0.8 V | 0.07 | - | 0.50 | 0.07 | 0.50 | 0.50 | V |
| | | V _{CC} = 1.1 V | 0.08 | - | 0.46 | 0.08 | 0.46 | 0.46 | V |
| | | V _{CC} = 1.4 V | 0.18 | - | 0.56 | 0.18 | 0.56 | 0.56 | V |
| | | V _{CC} = 1.65 V | 0.27 | - | 0.66 | 0.27 | 0.66 | 0.66 | V |
| | | V _{CC} = 2.3 V | 0.53 | - | 0.92 | 0.53 | 0.92 | 0.92 | V |
| | | V _{CC} = 3.0 V | 0.79 | - | 1.31 | 0.79 | 1.31 | 1.31 | V |

14. Waveforms transfer characteristics

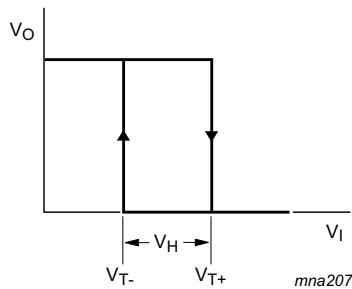
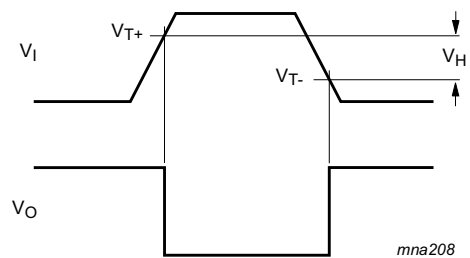

Fig 15. Transfer characteristic



V_{T+} and V_{T-} limits at 70 % and 20 %.

Fig 16. Definition of V_{T+}, V_{T-} and V_H

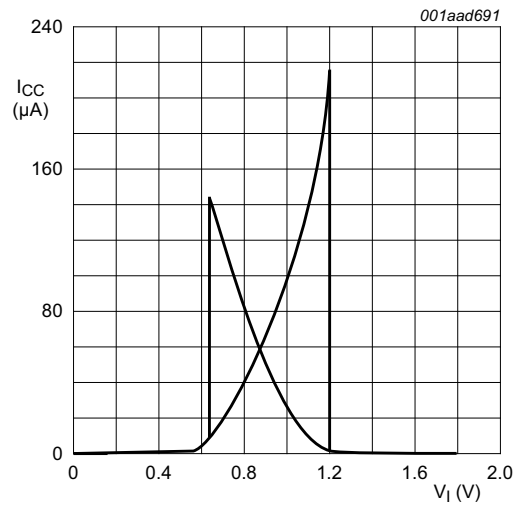

Fig 17. Typical transfer characteristics; V_{CC} = 1.8 V

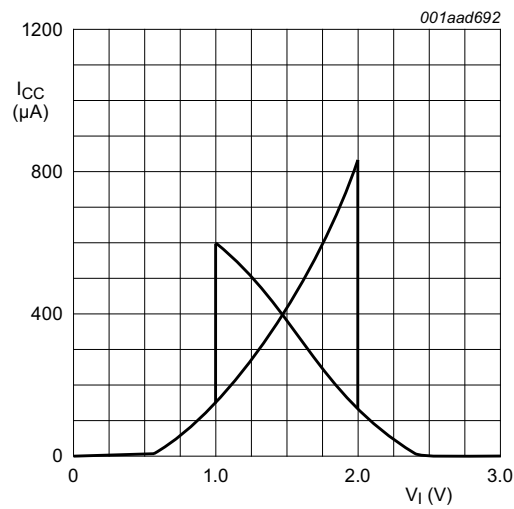

Fig 18. Typical transfer characteristics; V_{CC} = 3.0 V

15. Package outline

Plastic surface-mounted package; 6 leads

SOT363

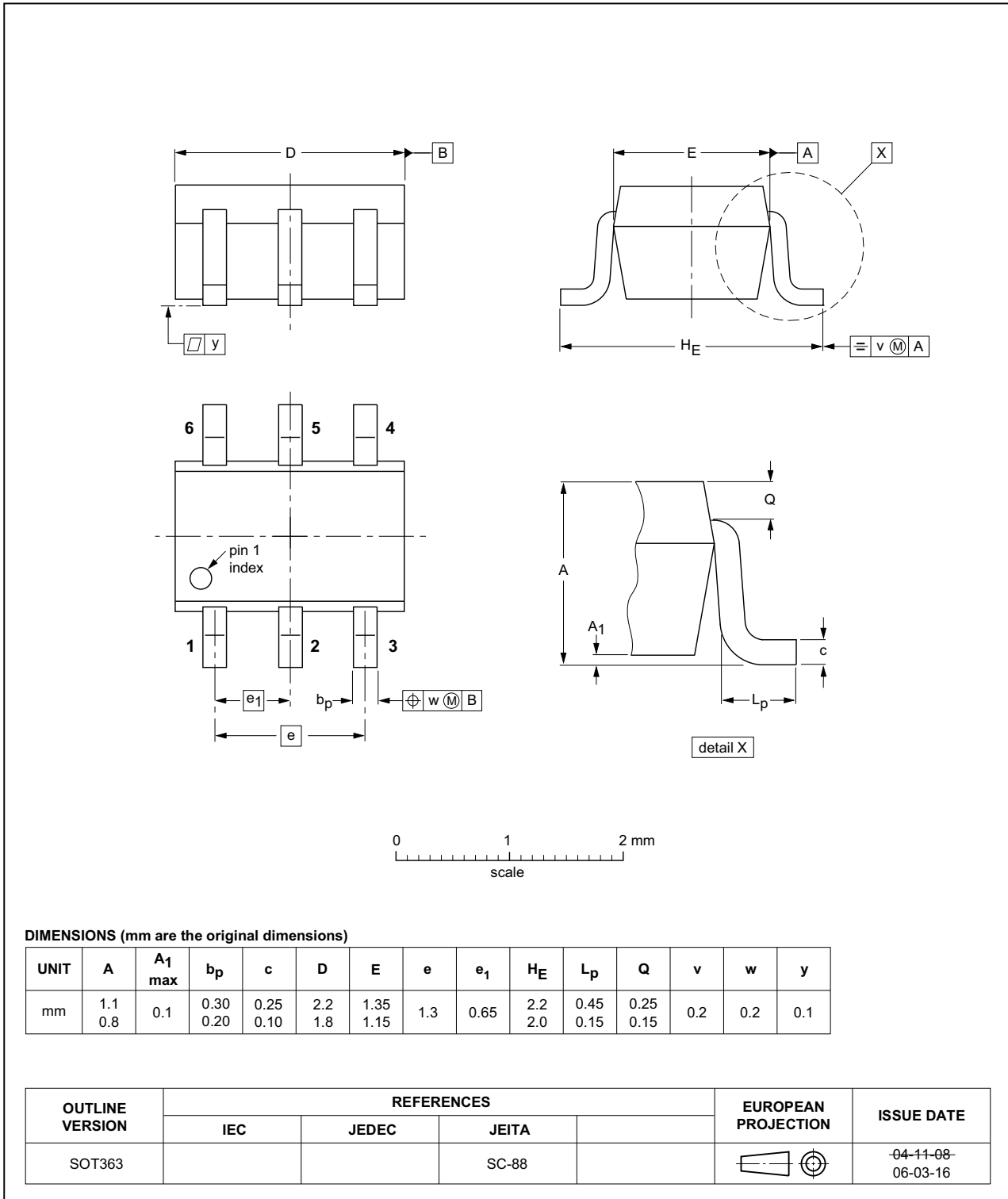

Fig 19. Package outline SOT363 (SC-88)

XSON6: plastic extremely thin small outline package; no leads; 6 terminals; body 1 x 1.45 x 0.5 mm

SOT886

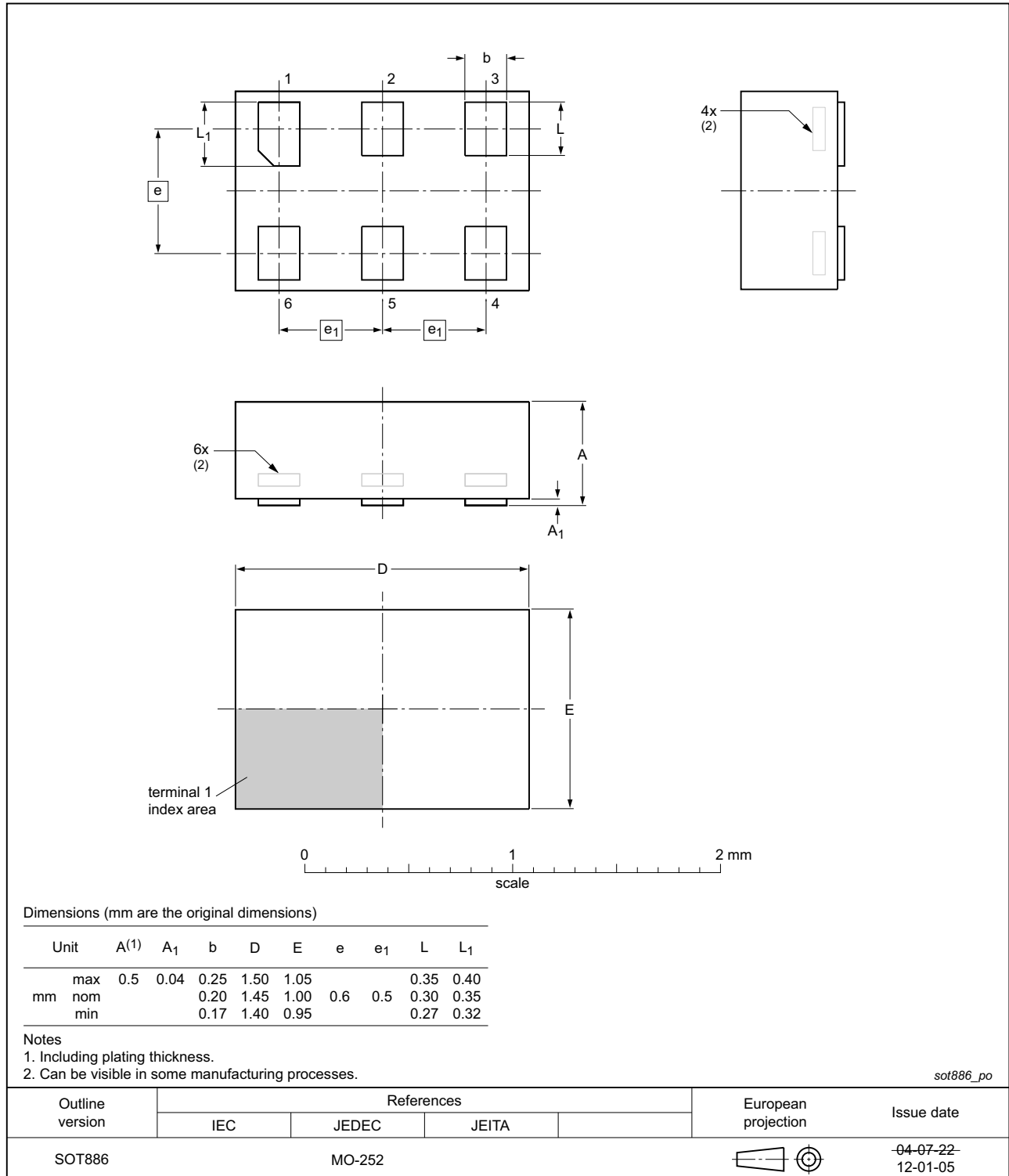

Fig 20. Package outline SOT886 (XSON6)

XSON6: plastic extremely thin small outline package; no leads; 6 terminals; body 1 x 1 x 0.5 mm

SOT891

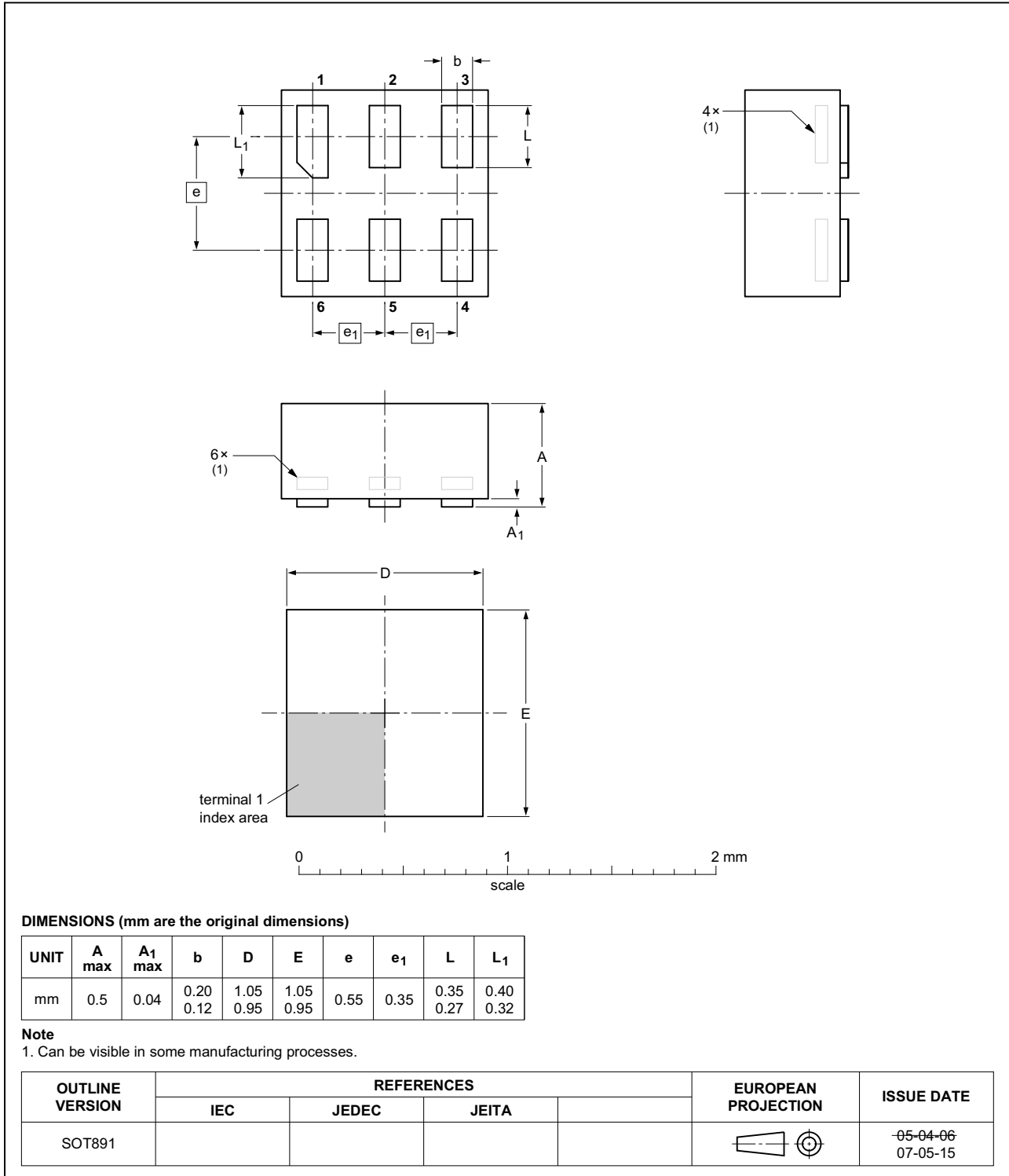

Fig 21. Package outline SOT891 (XSON6)

**XSON6: extremely thin small outline package; no leads;
6 terminals; body 0.9 x 1.0 x 0.35 mm**

SOT1115

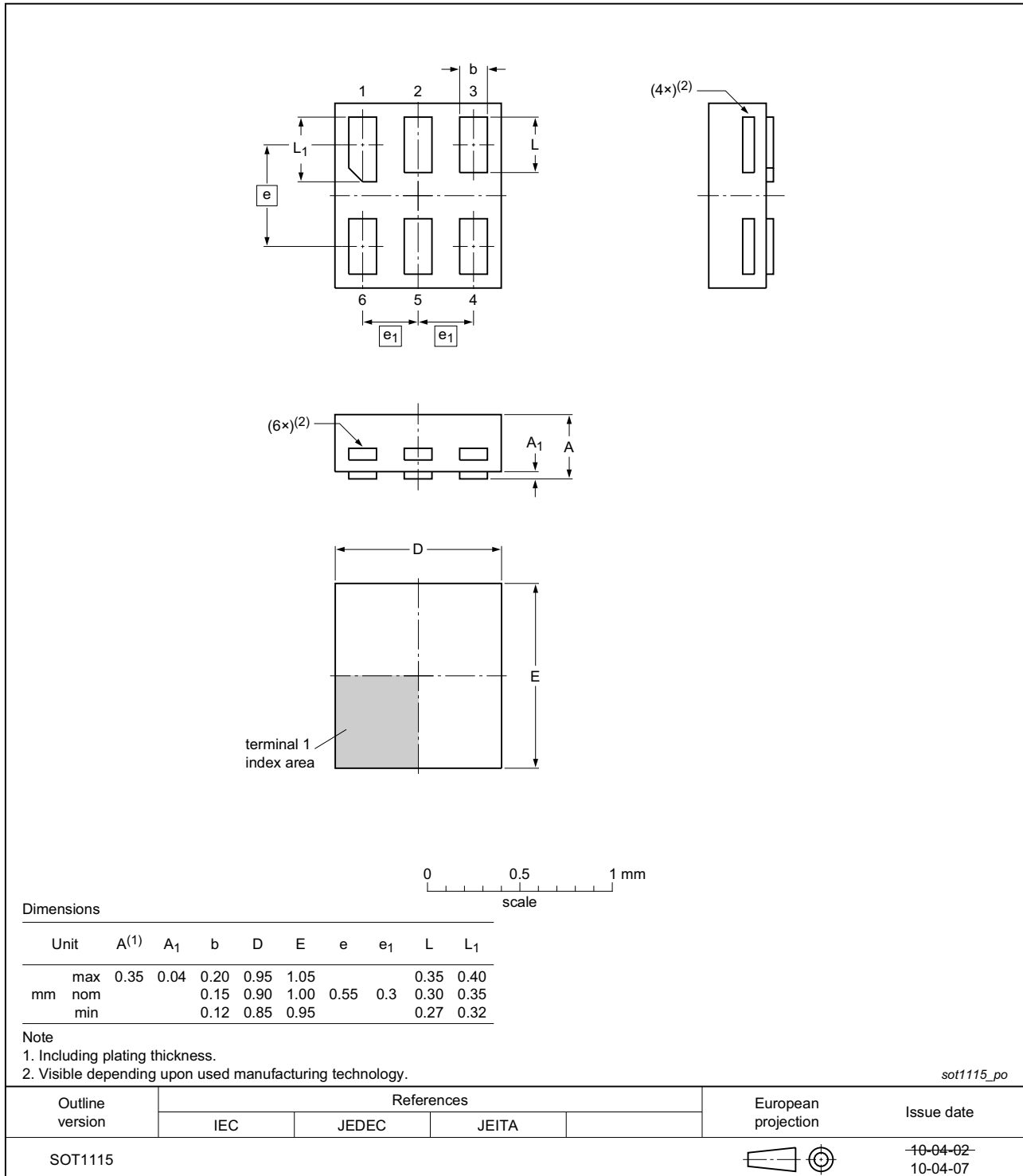

Fig 22. Package outline SOT1115 (XSON6)

**XSON6: extremely thin small outline package; no leads;
6 terminals; body 1.0 x 1.0 x 0.35 mm**

SOT1202

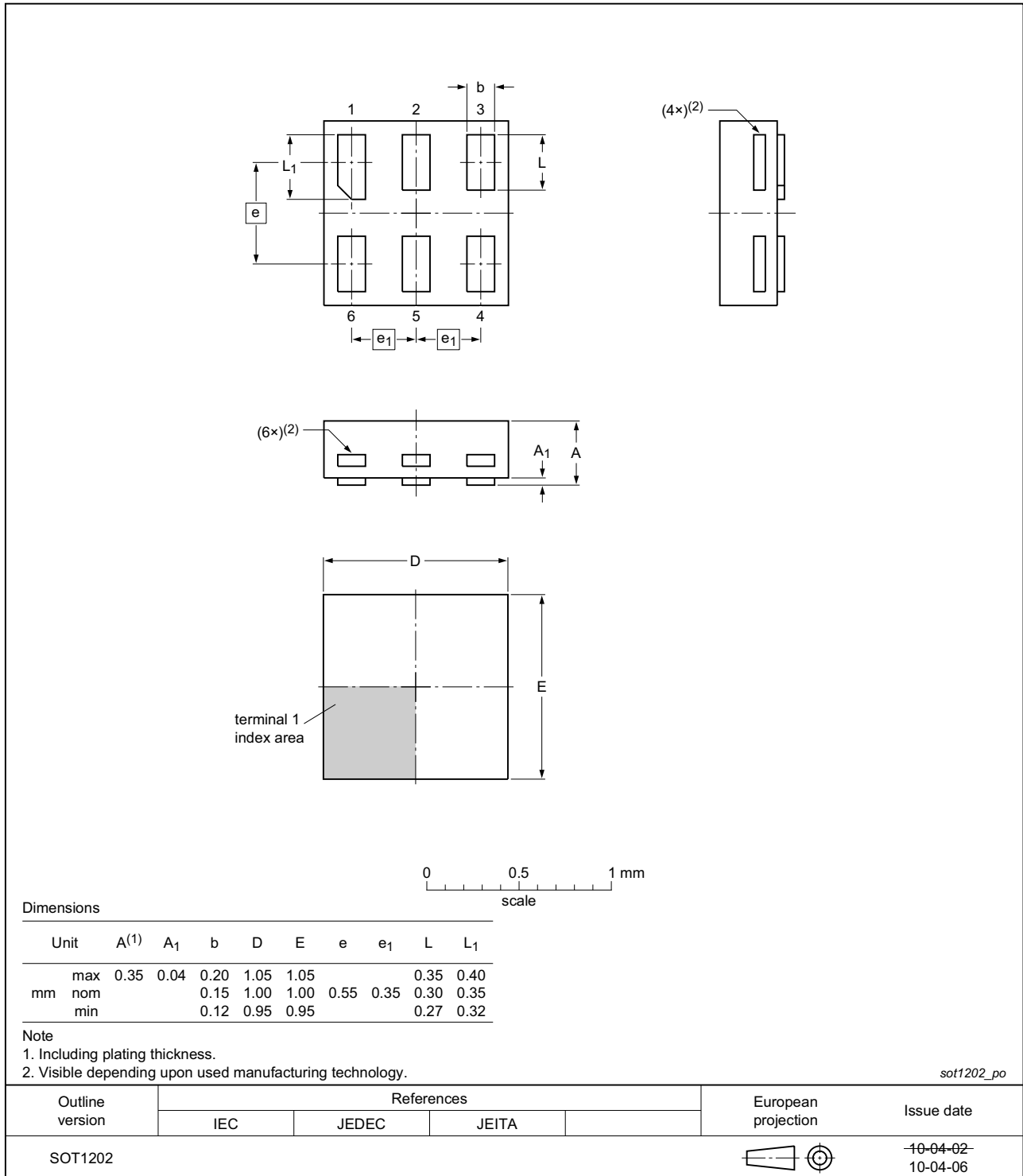

Fig 23. Package outline SOT1202 (XSON6)

**X2SON6: plastic thermal enhanced extremely thin small outline package; no leads;
6 terminals; body 1.0 x 0.8 x 0.35 mm**

SOT1255

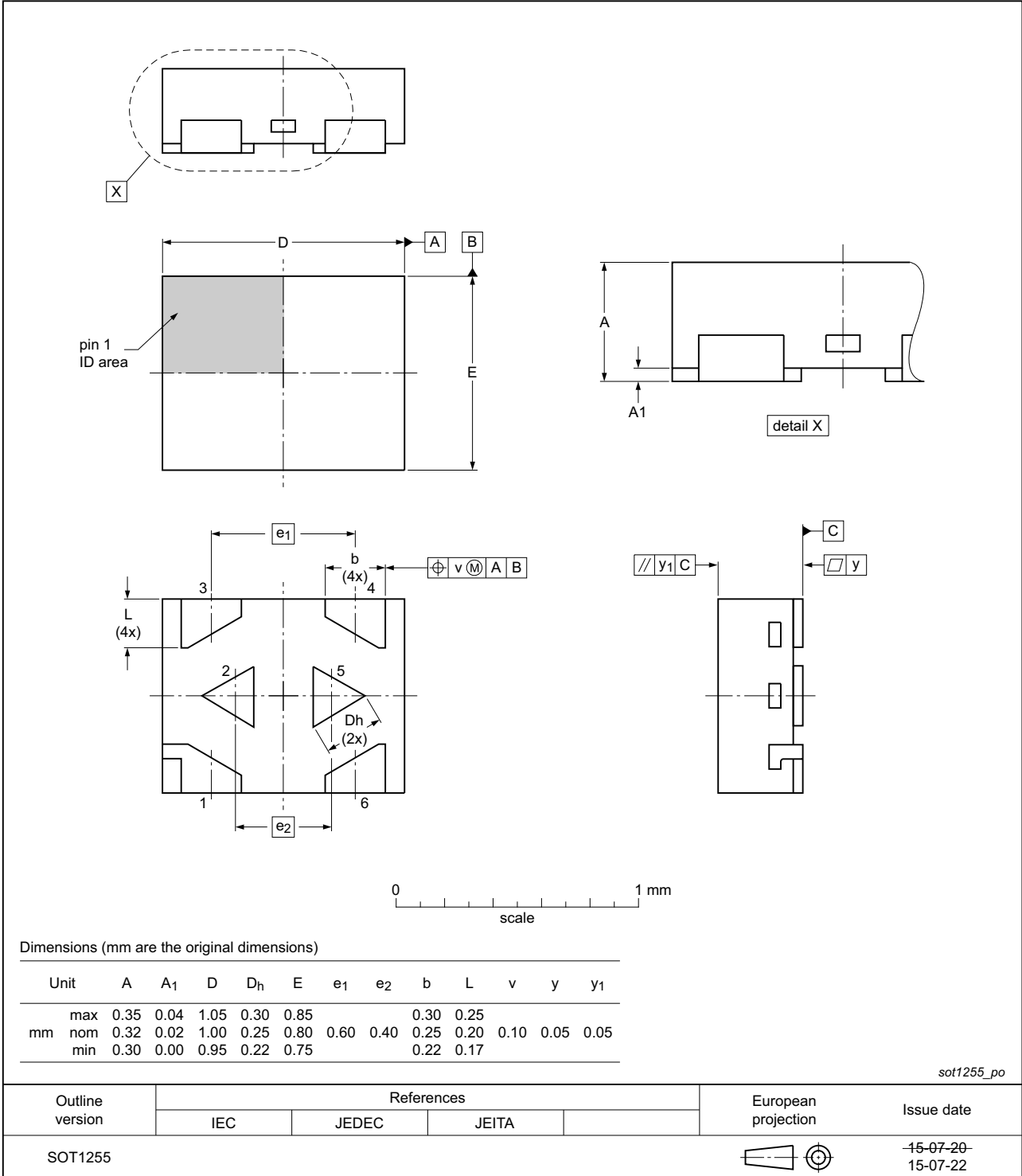

Fig 24. Package outline SOT1255 (X2SON6)

16. Abbreviations

Table 13. Abbreviations

| Acronym | Description |
|---------|-------------------------|
| CDM | Charged Device Model |
| DUT | Device Under Test |
| ESD | ElectroStatic Discharge |
| HBM | Human Body Model |
| MM | Machine Model |

17. Revision history

Table 14. Revision history

| Document ID | Release date | Data sheet status | Change notice | Supersedes |
|----------------|---|--------------------|---------------|---------------|
| 74AUP1G98 v.8 | 20150923 | Product data sheet | - | 74AUP1G98 v.7 |
| Modifications: | <ul style="list-style-type: none"> Added type number 74AUP1G98GX (SOT1255/X2SON6). | | | |
| 74AUP1G98 v.7 | 20120815 | Product data sheet | - | 74AUP1G98 v.6 |
| Modifications: | <ul style="list-style-type: none"> Package outline drawing of SOT886 (Figure 20) modified. | | | |
| 74AUP1G98 v.6 | 20111128 | Product data sheet | - | 74AUP1G98 v.5 |
| 74AUP1G98 v.5 | 20110105 | Product data sheet | - | 74AUP1G98 v.4 |
| 74AUP1G98 v.4 | 20101012 | Product data sheet | - | 74AUP1G98 v.3 |
| 74AUP1G98 v.3 | 20090629 | Product data sheet | - | 74AUP1G98 v.2 |
| 74AUP1G98 v.2 | 20090402 | Product data sheet | - | 74AUP1G98 v.1 |
| 74AUP1G98 v.1 | 20061108 | Product data sheet | - | - |

18. Legal information

18.1 Data sheet status

| Document status ^{[1][2]} | Product status ^[3] | Definition |
|-----------------------------------|-------------------------------|---|
| Objective [short] data sheet | Development | This document contains data from the objective specification for product development. |
| Preliminary [short] data sheet | Qualification | This document contains data from the preliminary specification. |
| Product [short] data sheet | Production | This document contains the product specification. |

[1] Please consult the most recently issued document before initiating or completing a design.

[2] The term 'short data sheet' is explained in section "Definitions".

[3] The product status of device(s) described in this document may have changed since this document was published and may differ in case of multiple devices. The latest product status information is available on the Internet at URL <http://www.nexperia.com>.

18.2 Definitions

Draft — The document is a draft version only. The content is still under internal review and subject to formal approval, which may result in modifications or additions. Nexperia does not give any representations or warranties as to the accuracy or completeness of information included herein and shall have no liability for the consequences of use of such information.

Short data sheet — A short data sheet is an extract from a full data sheet with the same product type number(s) and title. A short data sheet is intended for quick reference only and should not be relied upon to contain detailed and full information. For detailed and full information see the relevant full data sheet, which is available on request via the local Nexperia sales office. In case of any inconsistency or conflict with the short data sheet, the full data sheet shall prevail.

Product specification — The information and data provided in a Product data sheet shall define the specification of the product as agreed between Nexperia and its customer, unless Nexperia and customer have explicitly agreed otherwise in writing. In no event however, shall an agreement be valid in which the Nexperia product is deemed to offer functions and qualities beyond those described in the Product data sheet.

18.3 Disclaimers

Limited warranty and liability — Information in this document is believed to be accurate and reliable. However, Nexperia does not give any representations or warranties, expressed or implied, as to the accuracy or completeness of such information and shall have no liability for the consequences of use of such information. Nexperia takes no responsibility for the content in this document if provided by an information source outside of Nexperia.

In no event shall Nexperia be liable for any indirect, incidental, punitive, special or consequential damages (including - without limitation - lost profits, lost savings, business interruption, costs related to the removal or replacement of any products or rework charges) whether or not such damages are based on tort (including negligence), warranty, breach of contract or any other legal theory.

Notwithstanding any damages that customer might incur for any reason whatsoever, Nexperia's aggregate and cumulative liability towards customer for the products described herein shall be limited in accordance with the *Terms and conditions of commercial sale* of Nexperia.

Right to make changes — Nexperia reserves the right to make changes to information published in this document, including without limitation specifications and product descriptions, at any time and without notice. This document supersedes and replaces all information supplied prior to the publication hereof.

Suitability for use — Nexperia products are not designed, authorized or warranted to be suitable for use in life support, life-critical or safety-critical systems or equipment, nor in applications where failure or malfunction of a Nexperia product can reasonably be expected to result in personal injury, death or severe property or environmental damage. Nexperia and its suppliers accept no liability for inclusion and/or use of Nexperia products in such equipment or applications and therefore such inclusion and/or use is at the customer's own risk.

Applications — Applications that are described herein for any of these products are for illustrative purposes only. Nexperia makes no representation or warranty that such applications will be suitable for the specified use without further testing or modification.

Customers are responsible for the design and operation of their applications and products using Nexperia products, and Nexperia accepts no liability for any assistance with applications or customer product design. It is customer's sole responsibility to determine whether the Nexperia product is suitable and fit for the customer's applications and products planned, as well as for the planned application and use of customer's third party customer(s). Customers should provide appropriate design and operating safeguards to minimize the risks associated with their applications and products.

Nexperia does not accept any liability related to any default, damage, costs or problem which is based on any weakness or default in the customer's applications or products, or the application or use by customer's third party customer(s). Customer is responsible for doing all necessary testing for the customer's applications and products using Nexperia products in order to avoid a default of the applications and the products or of the application or use by customer's third party customer(s). Nexperia does not accept any liability in this respect.

Limiting values — Stress above one or more limiting values (as defined in the Absolute Maximum Ratings System of IEC 60134) will cause permanent damage to the device. Limiting values are stress ratings only and (proper) operation of the device at these or any other conditions above those given in the Recommended operating conditions section (if present) or the Characteristics sections of this document is not warranted. Constant or repeated exposure to limiting values will permanently and irreversibly affect the quality and reliability of the device.

Terms and conditions of commercial sale — Nexperia products are sold subject to the general terms and conditions of commercial sale, as published at <http://www.nexperia.com/profile/terms>, unless otherwise agreed in a valid written individual agreement. In case an individual agreement is concluded only the terms and conditions of the respective agreement shall apply. Nexperia hereby expressly objects to applying the customer's general terms and conditions with regard to the purchase of Nexperia products by customer.

No offer to sell or license — Nothing in this document may be interpreted or construed as an offer to sell products that is open for acceptance or the grant, conveyance or implication of any license under any copyrights, patents or other industrial or intellectual property rights.

Export control — This document as well as the item(s) described herein may be subject to export control regulations. Export might require a prior authorization from competent authorities.

Non-automotive qualified products — Unless this data sheet expressly states that this specific Nexperia product is automotive qualified, the product is not suitable for automotive use. It is neither qualified nor tested in accordance with automotive testing or application requirements. Nexperia accepts no liability for inclusion and/or use of non-automotive qualified products in automotive equipment or applications.

In the event that customer uses the product for design-in and use in automotive applications to automotive specifications and standards, customer (a) shall use the product without Nexperia's warranty of the product for such automotive applications, use and specifications, and (b) whenever customer uses the product for automotive applications beyond

Nexperia's specifications such use shall be solely at customer's own risk, and (c) customer fully indemnifies Nexperia for any liability, damages or failed product claims resulting from customer design and use of the product for automotive applications beyond Nexperia's standard warranty and Nexperia's product specifications.

Translations — A non-English (translated) version of a document is for reference only. The English version shall prevail in case of any discrepancy between the translated and English versions.

18.4 Trademarks

Notice: All referenced brands, product names, service names and trademarks are the property of their respective owners.

19. Contact information

For more information, please visit: <http://www.nexperia.com>

For sales office addresses, please send an email to: salesaddresses@nexperia.com

20. Contents

| | | |
|-----------|---|-----------|
| 1 | General description | 1 |
| 2 | Features and benefits | 1 |
| 3 | Ordering information | 2 |
| 4 | Marking | 2 |
| 5 | Functional diagram | 2 |
| 6 | Pinning information | 3 |
| 6.1 | Pinning | 3 |
| 6.2 | Pin description | 3 |
| 7 | Functional description | 4 |
| 7.1 | Logic configurations | 4 |
| 8 | Limiting values | 5 |
| 9 | Recommended operating conditions | 6 |
| 10 | Static characteristics | 6 |
| 11 | Dynamic characteristics | 9 |
| 12 | Waveforms | 11 |
| 13 | Transfer characteristics | 12 |
| 14 | Waveforms transfer characteristics | 13 |
| 15 | Package outline | 15 |
| 16 | Abbreviations | 21 |
| 17 | Revision history | 21 |
| 18 | Legal information | 22 |
| 18.1 | Data sheet status | 22 |
| 18.2 | Definitions | 22 |
| 18.3 | Disclaimers | 22 |
| 18.4 | Trademarks | 23 |
| 19 | Contact information | 23 |
| 20 | Contents | 24 |

Данный компонент на территории Российской Федерации

Вы можете приобрести в компании MosChip.

Для оперативного оформления запроса Вам необходимо перейти по данной ссылке:

<http://moschip.ru/get-element>

Вы можете разместить у нас заказ для любого Вашего проекта, будь то серийное производство или разработка единичного прибора.

В нашем ассортименте представлены ведущие мировые производители активных и пассивных электронных компонентов.

Нашей специализацией является поставка электронной компонентной базы двойного назначения, продукции таких производителей как XILINX, Intel (ex.ALTERA), Vicor, Microchip, Texas Instruments, Analog Devices, Mini-Circuits, Amphenol, Glenair.

Сотрудничество с глобальными дистрибьюторами электронных компонентов, предоставляет возможность заказывать и получать с международных складов практически любой перечень компонентов в оптимальные для Вас сроки.

На всех этапах разработки и производства наши партнеры могут получить квалифицированную поддержку опытных инженеров.

Система менеджмента качества компании отвечает требованиям в соответствии с ГОСТ Р ИСО 9001, ГОСТ РВ 0015-002 и ЭС РД 009

Офис по работе с юридическими лицами:

105318, г.Москва, ул.Щербаковская д.3, офис 1107, 1118, ДЦ «Щербаковский»

Телефон: +7 495 668-12-70 (многоканальный)

Факс: +7 495 668-12-70 (доб.304)

E-mail: info@moschip.ru

Skype отдела продаж:

moschip.ru

moschip.ru_4

moschip.ru_6

moschip.ru_9