

# High Speed Optocoupler, 1 MBd, Transistor Output

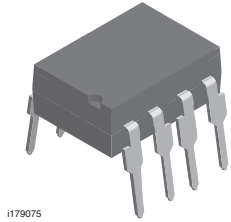

I179075

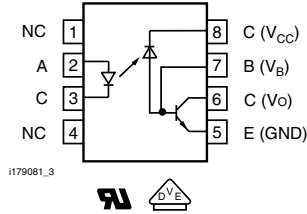

I179081\_3



## FEATURES

- Isolation test voltage 5300 V<sub>RMS</sub>
- TTL compatible
- High bit rates: 1 MBit/s
- High common mode interference immunity
- Bandwidth 2 MHz
- Open collector output
- External base wiring possible
- Compliant to RoHS Directive 2002/95/EC and in accordance to WEEE 2002/96/EC

**RoHS**  
COMPLIANT

## DESCRIPTION

The SFH6135 and SFH6136 optocouplers feature a high signal transmission rate and a high isolation resistance. They have a GaAlAs infrared emitting diode, optically coupled with an integrated photo detector which consists of a photo diode and a high-speed transistor in a DIP-8 plastic package. Signals can be transmitted between two electrically separated circuits up to frequencies of 2 MHz. The potential difference between the circuits to be coupled should not exceed the maximum permissible reference voltages.

## AGENCY APPROVALS

- UL1577, file no. E52744 system code H or J, double protection
- CSA 93751
- DIN EN 60747-5-5 (VDE 0884)

## ORDERING INFORMATION

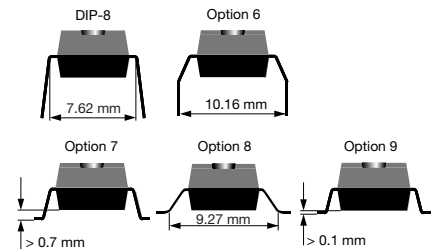
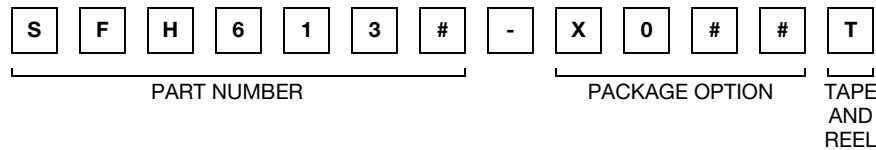

AGENCY CERTIFIED/PACKAGE	CTR (%)	
<b>UL</b>	<b>≥ 7</b>	<b>≥ 19</b>
DIP-8	SFH6135	SFH6136
DIP-8, 400 mil, option 6	SFH6135-X006	SFH6136-X006
SMD-8, option 7	SFH6135-X007T <sup>(1)</sup>	SFH6136-X007
SMD-8, option 9	-	SFH6136-X009T
<b>VDE, UL</b>	<b>≥ 7</b>	<b>≥ 19</b>
DIP-8	SFH6135-X001	SFH6136-X001
DIP-8, 400 mil, option 6	-	SFH6136-X016
SMD-8, option 7	-	SFH6136-X017T <sup>(1)</sup>
SMD-8, option 8	-	SFH6136-X018
SMD-8, option 9	SFH6135-X019	SFH6136-X019T <sup>(1)</sup>

### Note

<sup>(1)</sup> Also available in tubes; do not add T to end

<b>ABSOLUTE MAXIMUM RATINGS</b> ( $T_{amb} = 25\text{ }^{\circ}\text{C}$ , unless otherwise specified)				
PARAMETER	TEST CONDITION	SYMBOL	VALUE	UNIT
<b>INPUT</b>				
Reverse voltage		$V_R$	3	V
Forward current		$I_F$	25	mA
Peak forward current	$t = 1\text{ ms}$ , duty cycle 50 %	$I_{FM}$	50	mA
Maximum surge forward current	$t \leq 1\text{ }\mu\text{s}$ , 300 pulses/s	$I_{FSM}$	1	A
Thermal resistance		$R_{thja}$	700	K/W
Power dissipation		$P_{diss}$	45	mW
<b>OUTPUT</b>				
Supply voltage		$V_S$	- 0.5 to 30	V
Output voltage		$V_O$	- 0.5 to 25	V
Emitter base voltage		$V_{EBO}$	5	V
Output current		$I_O$	8	mA
Maximum output current		$I_O$	16	mA
Base current		$I_B$	5	mA
Thermal resistance		$R_{thja}$	300	K/W
Power dissipation	$T_{amb} = 70\text{ }^{\circ}\text{C}$	$P_{diss}$	100	mW
<b>COUPLER</b>				
Isolation test voltage		$V_{ISO}$	5300	$V_{RMS}$
Pollution degree (DIN VDE 0110)			2	
Isolation resistance	$V_{IO} = 500\text{ V}$ , $T_{amb} = 25\text{ }^{\circ}\text{C}$	$R_{IO}$	$\geq 10^{12}$	$\Omega$
	$V_{IO} = 500\text{ V}$ , $T_{amb} = 100\text{ }^{\circ}\text{C}$	$R_{IO}$	$\geq 10^{11}$	$\Omega$
Storage temperature range		$T_{stg}$	- 55 to + 125	$^{\circ}\text{C}$
Ambient temperature range		$T_{amb}$	- 55 to + 100	$^{\circ}\text{C}$
Soldering temperature <sup>(1)</sup>	max. $\leq 10\text{ s}$ , dip soldering $\geq 0.5\text{ mm}$ distance from case bottom	$T_{sld}$	260	$^{\circ}\text{C}$

### Notes

- Stresses in excess of the absolute maximum ratings can cause permanent damage to the device. Functional operation of the device is not implied at these or any other conditions in excess of those given in the operational sections of this document. Exposure to absolute maximum ratings for extended periods of the time can adversely affect reliability.

<sup>(1)</sup> Refer to wave profile for soldering conditions for through hole devices .

<b>ELECTRICAL CHARACTERISTICS</b> ( $T_{amb} = 25\text{ }^{\circ}\text{C}$ , unless otherwise specified)							
PARAMETER	TEST CONDITION	PART	SYMBOL	MIN.	TYP.	MAX.	UNIT
<b>INPUT</b>							
Forward voltage	$I_F = 16\text{ mA}$		$V_F$		1.6	1.9	V
Breakdown voltage	$I_R = 10\text{ }\mu\text{A}$		$V_{BR}$	3			V
Reverse current	$V_R = 3\text{ V}$		$I_R$		0.5	10	$\mu\text{A}$
Capacitance	$V_R = 0\text{ V}$ , $f = 1\text{ MHz}$		$C_O$		125		pF
Temperature coefficient of forward voltage	$I_F = 16\text{ mA}$		$\Delta V_F / \Delta T_{amb}$		1.7		mV/ $^{\circ}\text{C}$
<b>OUTPUT</b>							
Logic low supply current	$I_F = 16\text{ mA}$ , $V_O = \text{open}$ , $V_{CC} = 15\text{ V}$		$I_{CCL}$		150		$\mu\text{A}$
Logic high supply current	$I_F = 0\text{ V}$ , $V_O = \text{open}$ , $V_{CC} = 15\text{ V}$		$I_{CCH}$		0.01	1	$\mu\text{A}$
Output voltage, output low	$I_F = 16\text{ mA}$ , $V_{CC} = 4.5\text{ V}$ , $I_O = 1.1\text{ mA}$	SFH6135	$V_{OL}$		0.1	0.4	V
	$I_F = 16\text{ mA}$ , $V_{CC} = 4.5\text{ V}$ , $I_O = 2.4\text{ mA}$	SFH6136	$V_{OL}$		0.1	0.4	V
Output current, output high	$I_F = 0\text{ mA}$ , $V_O = V_{CC} = 5.5\text{ V}$		$I_{OH}$		3	500	nA
	$I_F = 0\text{ mA}$ , $V_O = V_{CC} = 15\text{ V}$		$I_{OH}$		0.01	1	$\mu\text{A}$

<b>ELECTRICAL CHARACTERISTICS</b> ( $T_{amb} = 25\text{ }^{\circ}\text{C}$ , unless otherwise specified)							
PARAMETER	TEST CONDITION	PART	SYMBOL	MIN.	TYP.	MAX.	UNIT
<b>COUPLER</b>							
Capacitance (input to output)	$f = 1\text{ MHz}$		$C_{IO}$		0.6		pF

**Note**

- Minimum and maximum values are testing requirements. Typical values are characteristics of the device and are the result of engineering evaluation. Typical values are for information only and are not part of the testing requirements.

<b>CURRENT TRANSFER RATIO</b>							
PARAMETER	TEST CONDITION	PART	SYMBOL	MIN.	TYP.	MAX.	UNIT
Current transfer ratio	$I_F = 16\text{ mA}$ , $V_O = 0.4\text{ V}$ , $V_{CC} = 4.5\text{ V}$	SFH6135	CTR	7	16		%
		SFH6136	CTR	19	35		%
	$I_F = 16\text{ mA}$ , $V_O = 0.5\text{ V}$ , $V_{CC} = 4.5\text{ V}$	SFH6135	CTR	5			%
		SFH6136	CTR	15			%

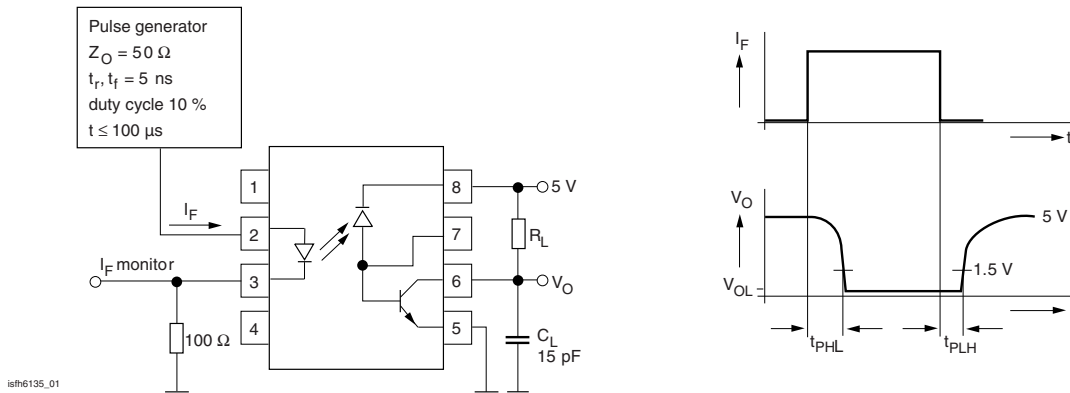

Fig. 1 - Schematics

<b>SWITCHING CHARACTERISTICS</b>							
PARAMETER	TEST CONDITION	PART	SYMBOL	MIN.	TYP.	MAX.	UNIT
High to low	$I_F = 16\text{ mA}$ , $V_{CC} = 5\text{ V}$ , $R_L = 4.1\text{ k}\Omega$	SFH6135	$t_{PHL}$		0.3	1.5	$\mu\text{s}$
	$I_F = 16\text{ mA}$ , $V_{CC} = 5\text{ V}$ , $R_L = 1.9\text{ k}\Omega$	SFH6136	$t_{PHL}$		0.2	0.8	$\mu\text{s}$
Low to high	$I_F = 16\text{ mA}$ , $V_{CC} = 5\text{ V}$ , $R_L = 4.1\text{ k}\Omega$	SFH6135	$t_{PLH}$		0.3	1.5	$\mu\text{s}$
	$I_F = 16\text{ mA}$ , $V_{CC} = 5\text{ V}$ , $R_L = 1.9\text{ k}\Omega$	SFH6136	$t_{PLH}$		0.2	0.8	$\mu\text{s}$

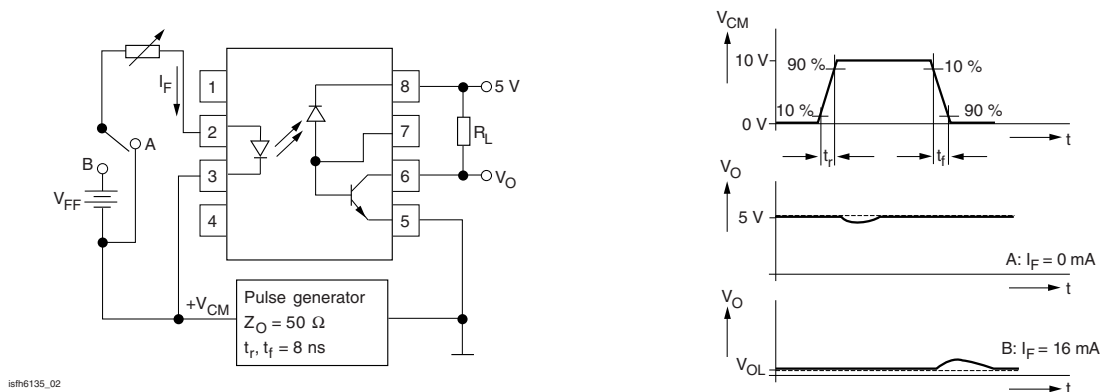

Fig. 2 - Common Mode Interference Immunity

COMMON MODE TRANSIENT IMMUNITY							
PARAMETER	TEST CONDITION	PART	SYMBOL	MIN.	TYP.	MAX.	UNIT
High	$V_{CM} = 10 V_{P-P}, V_{CC} = 5 V,$ $I_F = 0 mA, R_L = 4.1 k\Omega$	SFH6135	CM <sub>H</sub>		1000		V/ $\mu$ s
	$V_{CM} = 10 V_{P-P}, V_{CC} = 5 V,$ $I_F = 0 mA, R_L = 1.9 k\Omega$	SFH6136	CM <sub>H</sub>		1000		V/ $\mu$ s
Low	$V_{CM} = 10 V_{P-P}, V_{CC} = 5 V,$ $I_F = 0 mA, R_L = 4.1 k\Omega$	SFH6135	CM <sub>L</sub>		1000		V/ $\mu$ s
	$V_{CM} = 10 V_{P-P}, V_{CC} = 5 V,$ $I_F = 0 mA, R_L = 1.9 k\Omega$	SFH6136	CM <sub>L</sub>		1000		V/ $\mu$ s

SAFETY AND INSULATION RATINGS							
PARAMETER	TEST CONDITION	SYMBOL	MIN.	TYP.	MAX.	UNIT	
Climatic classification (according to IEC 68 part 1)				55/100/21			
Comparative tracking index		CTI	175		399		
V <sub>IOTM</sub>			8000				V
V <sub>IORM</sub>			890				V
P <sub>SO</sub>					500		mW
I <sub>SI</sub>					300		mA
T <sub>SI</sub>					175		°C
Creepage distance	Standard DIP-8		7				mm
Clearance distance	Standard DIP-8		7				mm
Creepage distance	400 mil DIP-8		8				mm
Clearance distance	400 mil DIP-8		8				mm

**Note**

- As per IEC 60747-5-5, §7.4.3.8.1, this optocoupler is suitable for “safe electrical insulation” only within the safety ratings. Compliance with the safety ratings shall be ensured by means of protective circuits.

**TYPICAL CHARACTERISTICS** (T<sub>amb</sub> = 25 °C, unless otherwise specified)

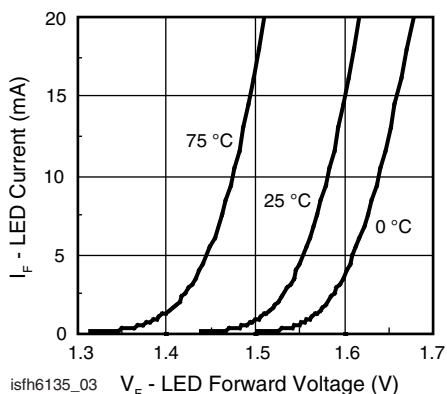

Fig. 3 - LED Forward Current vs. Forward Voltage

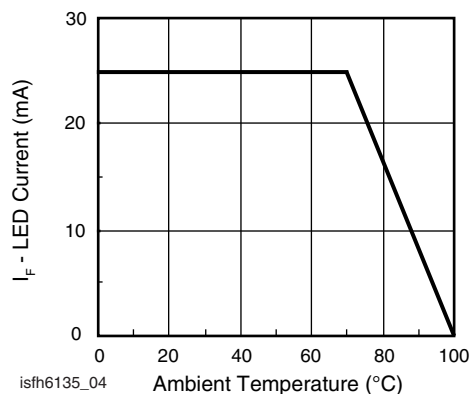

Fig. 4 - Permissible Forward LED Current vs. Temperature

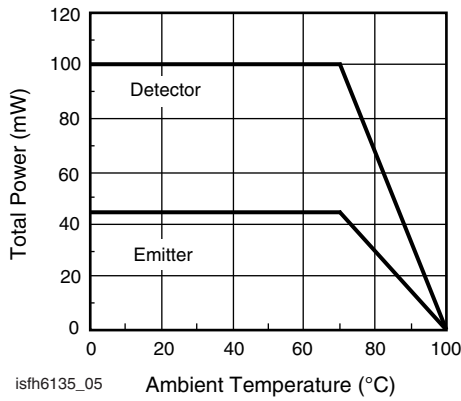

Fig. 5 - Permissible Power Dissipation vs. Temperature

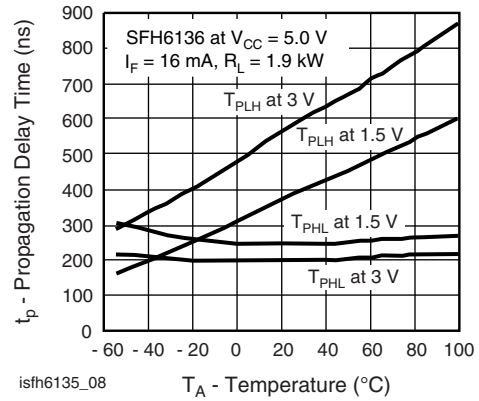

Fig. 8 - Propagation Delay vs. Ambient Temperature - SFH6136

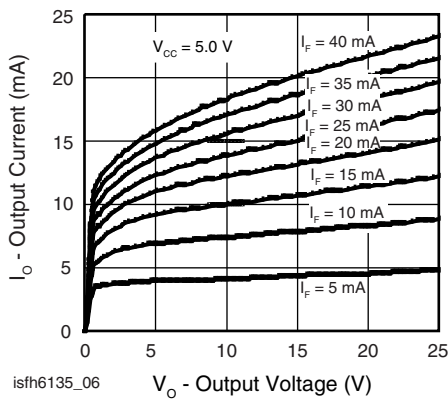

Fig. 6 - Output Current vs. Output Voltage

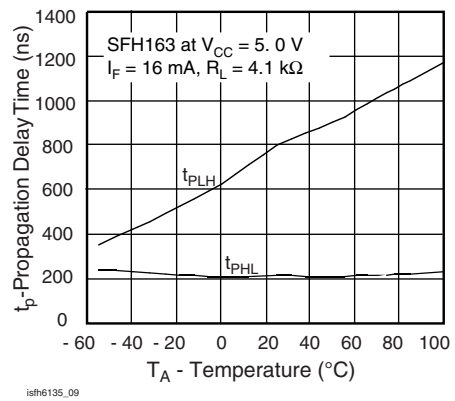

Fig. 9 - Propagation Delay vs. Ambient Temperature - SFH6135

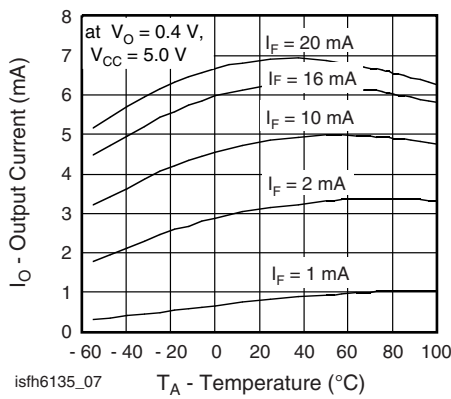

Fig. 7 - Output Current vs. Temperature

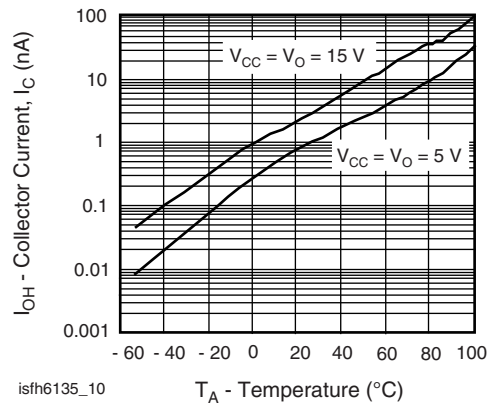

Fig. 10 - Logic High Output Current vs. Temperature

# SFH6135, SFH6136



Vishay Semiconductors High Speed Optocoupler, 1 MBd,  
Transistor Output

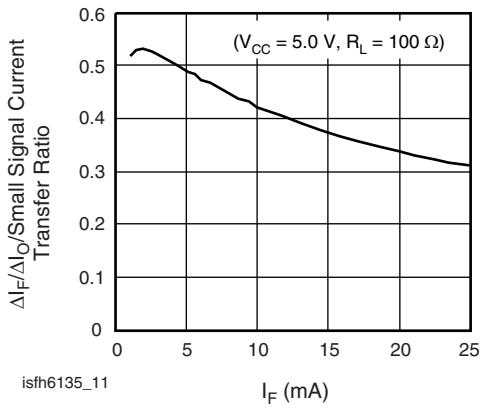
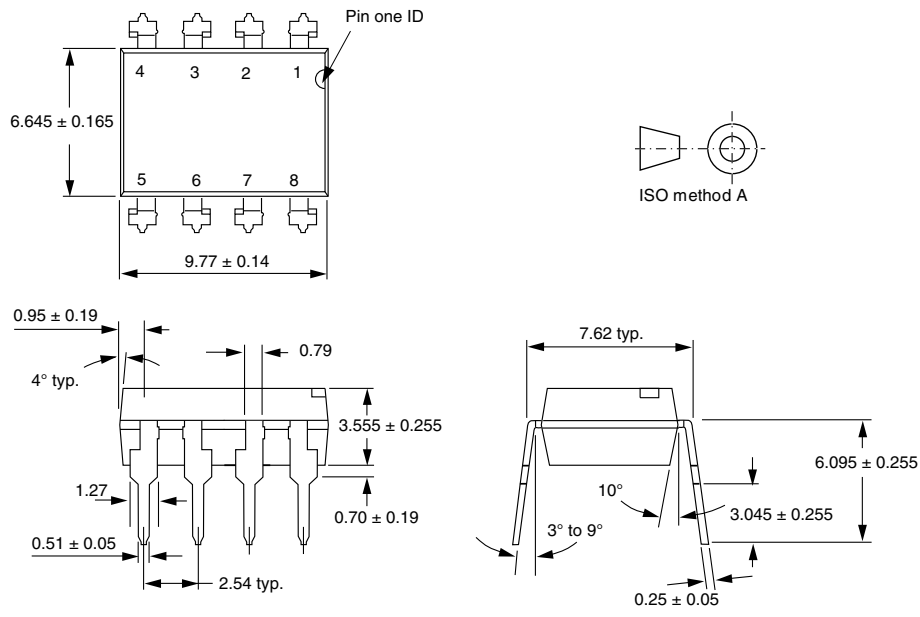

Fig. 11 - Small Signal Current Transfer Ratio vs. Quiescent Input Current

## PACKAGE DIMENSIONS in millimeters





# SFH6135, SFH6136

High Speed Optocoupler, 1 MBd, Transistor Output  
Vishay Semiconductors

Option 6

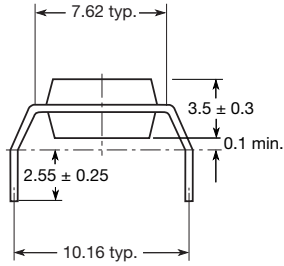

Option 7

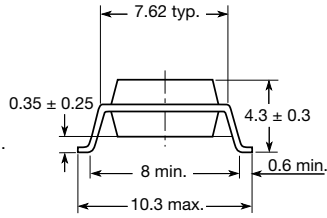

Option 8

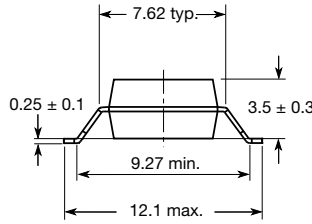

Option 9

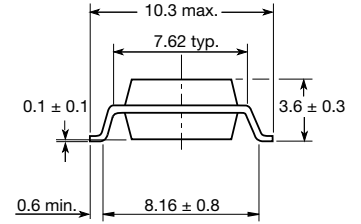

20802-1

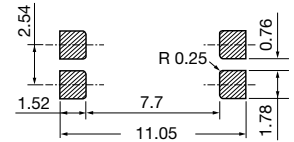
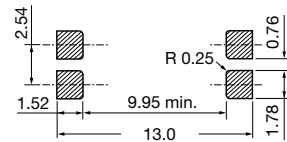
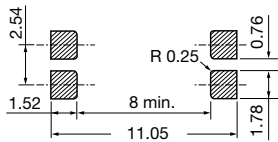

## PACKAGE MARKING

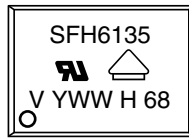

21764-66



## Disclaimer

ALL PRODUCT, PRODUCT SPECIFICATIONS AND DATA ARE SUBJECT TO CHANGE WITHOUT NOTICE TO IMPROVE RELIABILITY, FUNCTION OR DESIGN OR OTHERWISE.

Vishay Intertechnology, Inc., its affiliates, agents, and employees, and all persons acting on its or their behalf (collectively, "Vishay"), disclaim any and all liability for any errors, inaccuracies or incompleteness contained in any datasheet or in any other disclosure relating to any product.

Vishay makes no warranty, representation or guarantee regarding the suitability of the products for any particular purpose or the continuing production of any product. To the maximum extent permitted by applicable law, Vishay disclaims (i) any and all liability arising out of the application or use of any product, (ii) any and all liability, including without limitation special, consequential or incidental damages, and (iii) any and all implied warranties, including warranties of fitness for particular purpose, non-infringement and merchantability.

Statements regarding the suitability of products for certain types of applications are based on Vishay's knowledge of typical requirements that are often placed on Vishay products in generic applications. Such statements are not binding statements about the suitability of products for a particular application. It is the customer's responsibility to validate that a particular product with the properties described in the product specification is suitable for use in a particular application. Parameters provided in datasheets and/or specifications may vary in different applications and performance may vary over time. All operating parameters, including typical parameters, must be validated for each customer application by the customer's technical experts. Product specifications do not expand or otherwise modify Vishay's terms and conditions of purchase, including but not limited to the warranty expressed therein.

Except as expressly indicated in writing, Vishay products are not designed for use in medical, life-saving, or life-sustaining applications or for any other application in which the failure of the Vishay product could result in personal injury or death. Customers using or selling Vishay products not expressly indicated for use in such applications do so at their own risk. Please contact authorized Vishay personnel to obtain written terms and conditions regarding products designed for such applications.

No license, express or implied, by estoppel or otherwise, to any intellectual property rights is granted by this document or by any conduct of Vishay. Product names and markings noted herein may be trademarks of their respective owners.

## Material Category Policy

**Vishay Intertechnology, Inc. hereby certifies that all its products that are identified as RoHS-Compliant fulfill the definitions and restrictions defined under Directive 2011/65/EU of The European Parliament and of the Council of June 8, 2011 on the restriction of the use of certain hazardous substances in electrical and electronic equipment (EEE) - recast, unless otherwise specified as non-compliant.**

**Please note that some Vishay documentation may still make reference to RoHS Directive 2002/95/EC. We confirm that all the products identified as being compliant to Directive 2002/95/EC conform to Directive 2011/65/EU.**

**Vishay Intertechnology, Inc. hereby certifies that all its products that are identified as Halogen-Free follow Halogen-Free requirements as per JEDEC JS709A standards. Please note that some Vishay documentation may still make reference to the IEC 61249-2-21 definition. We confirm that all the products identified as being compliant to IEC 61249-2-21 conform to JEDEC JS709A standards.**



## Данный компонент на территории Российской Федерации

### Вы можете приобрести в компании MosChip.

Для оперативного оформления запроса Вам необходимо перейти по данной ссылке:

<http://moschip.ru/get-element>

Вы можете разместить у нас заказ для любого Вашего проекта, будь то серийное производство или разработка единичного прибора.

В нашем ассортименте представлены ведущие мировые производители активных и пассивных электронных компонентов.

Нашей специализацией является поставка электронной компонентной базы двойного назначения, продукции таких производителей как XILINX, Intel (ex.ALTERA), Vicor, Microchip, Texas Instruments, Analog Devices, Mini-Circuits, Amphenol, Glenair.

Сотрудничество с глобальными дистрибьюторами электронных компонентов, предоставляет возможность заказывать и получать с международных складов практически любой перечень компонентов в оптимальные для Вас сроки.

На всех этапах разработки и производства наши партнеры могут получить квалифицированную поддержку опытных инженеров.

Система менеджмента качества компании отвечает требованиям в соответствии с ГОСТ Р ИСО 9001, ГОСТ РВ 0015-002 и ЭС РД 009

### Офис по работе с юридическими лицами:

105318, г.Москва, ул.Щербаковская д.3, офис 1107, 1118, ДЦ «Щербаковский»

Телефон: +7 495 668-12-70 (многоканальный)

Факс: +7 495 668-12-70 (доб.304)

E-mail: [info@moschip.ru](mailto:info@moschip.ru)

Skype отдела продаж:

moschip.ru

moschip.ru\_4

moschip.ru\_6

moschip.ru\_9