

# High Side Current Sense Amplifier with Reference and Comparator

## FEATURES

- Current Sense Amplifier
  - Fast Step Response: 500ns
  - Low Offset Voltage: 125 $\mu$ V Maximum
  - Low Gain Error: 0.2% Maximum
- Internal 400mV Precision Reference
- Internal Comparator
  - Fast Response Time: 500ns
  - Total Threshold Error:  $\pm$ 1.25% Maximum
  - Latching or Non-Latching Comparator Option
- Wide Supply Range: 2.7V to 60V
- Supply Current: 450 $\mu$ A
- Low Shutdown Current: 5 $\mu$ A Maximum
- Specified for  $-40^{\circ}\text{C}$  to  $125^{\circ}\text{C}$  Temperature Range
- Available in 8-Lead MSOP and 8-Lead (2mm  $\times$  3mm) DFN Packages

## APPLICATIONS

- Overcurrent and Fault Detection
- Current Shunt Measurement
- Battery Monitoring
- Motor Control
- Automotive Monitoring and Control
- Remote Sensing
- Industrial Control

## DESCRIPTION

The LT<sup>®</sup>6108 is a complete high side current sense device that incorporates a precision current sense amplifier, an integrated voltage reference and a comparator. Two versions of the LT6108 are available. The LT6108-1 has a latching comparator and the LT6108-2 has a non-latching comparator. In addition, the current sense amplifier and comparator inputs and outputs are directly accessible. The amplifier gain and comparator trip point are configured by external resistors. The open-drain comparator output allows for easy interface to other system components.

The overall propagation delay of the LT6108 is typically only 1.4 $\mu$ s, allowing for quick reaction to overcurrent conditions. The 1MHz bandwidth allows the LT6108 to be used for error detection in critical applications such as motor control. The high threshold accuracy of the comparator, combined with the ability to latch the comparator, ensures the LT6108 can capture high speed events.

The LT6108 is fully specified for operation from  $-40^{\circ}\text{C}$  to  $125^{\circ}\text{C}$ , making it suitable for industrial and automotive applications. The LT6108 is available in the small 8-lead MSOP and 8-lead DFN packages.

LT, LT, LTC, LTM, TimerBlox, Linear Technology and the Linear logo are registered trademarks of Linear Technology Corporation. All other trademarks are the property of their respective owners.

## TYPICAL APPLICATION

Circuit Fault Protection with Very Fast Latching Load Disconnect

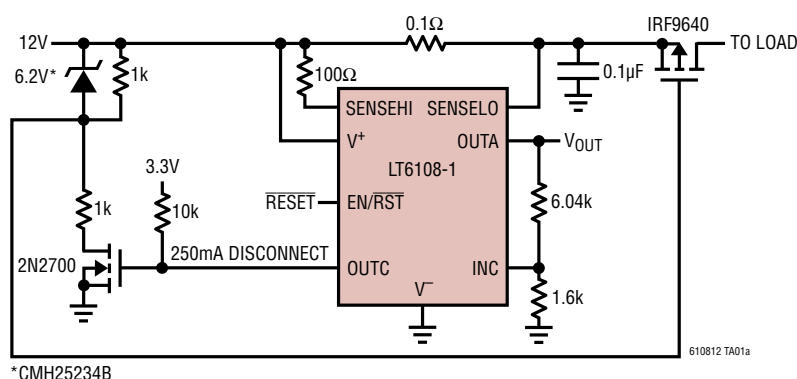

Response to Overcurrent Event

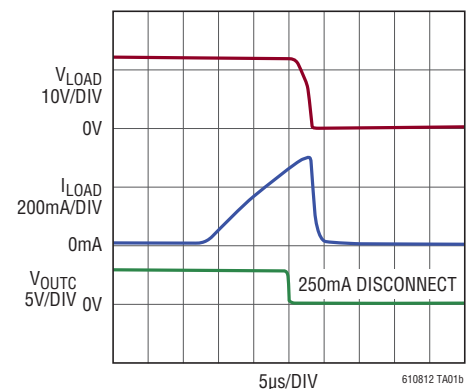

# LT6108-1/LT6108-2

## ABSOLUTE MAXIMUM RATINGS (Note 1)

Total Supply Voltage ( $V^+$ to $V^-$ ) .....	60V	Amplifier Output Short-Circuit Duration (to $V^-$ )..	Indefinite
Maximum Voltage (SENSELO, SENSEHI, OUTA).....	$V^+ + 1V$	Operating Temperature Range (Note 3)	
Maximum $V^+ -$ (SENSELO or SENSEHI).....	33V	LT6108I.....	-40°C to 85°C
Maximum EN, EN/ $\overline{RST}$ Voltage .....	60V	LT6108H .....	-40°C to 125°C
Maximum Comparator Input Voltage .....	60V	Specified Temperature Range (Note 3)	
Maximum Comparator Output Voltage.....	60V	LT6108I.....	-40°C to 85°C
Input Current (Note 2).....	-10mA	LT6108H .....	-40°C to 125°C
SENSEHI, SENSELO Input Current .....	$\pm 10mA$	Maximum Junction Temperature .....	150°C
Differential SENSEHI or SENSELO Input Current ..	$\pm 2.5mA$	Storage Temperature Range .....	-65°C to 150°C
		MSOP Lead Temperature (Soldering, 10 sec).....	300°C

## PIN CONFIGURATION

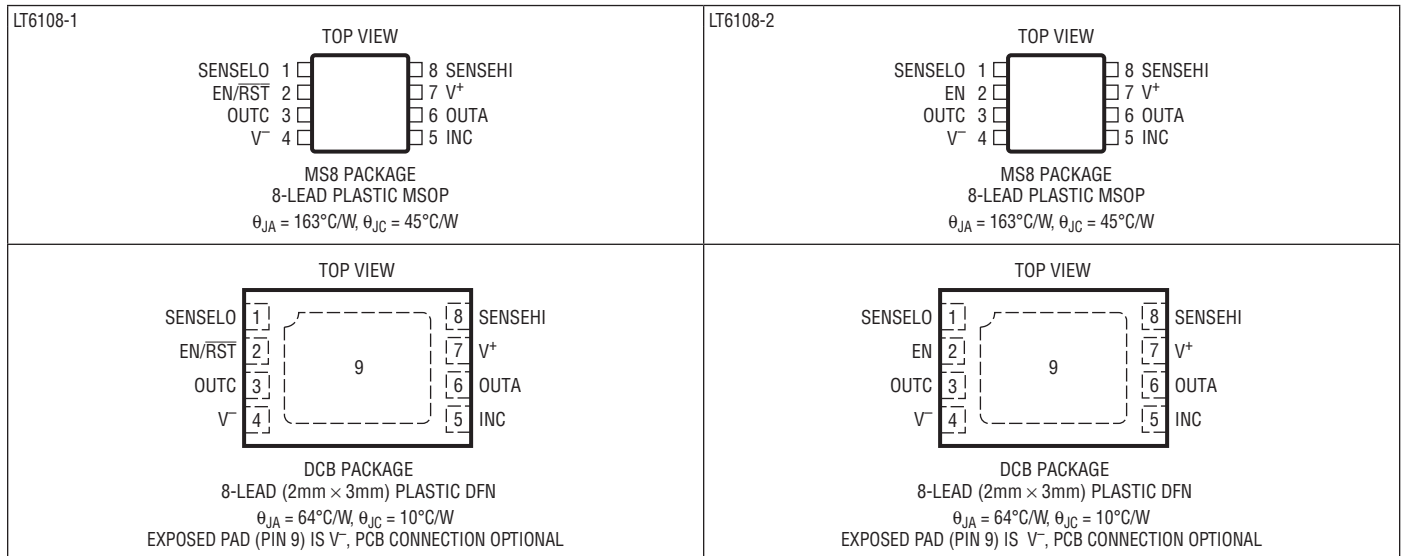

## ORDER INFORMATION

LEAD FREE FINISH	TAPE AND REEL	PART MARKING*	PACKAGE DESCRIPTION	SPECIFIED TEMPERATURE RANGE
LT6108AIMS8-1#PBF	LT6108AIMS8-1#TRPBF	LTfND	8-Lead Plastic MSOP	-40°C to 85°C
LT6108IMS8-1#PBF	LT6108IMS8-1#TRPBF	LTfND	8-Lead Plastic MSOP	-40°C to 85°C
LT6108AHMS8-1#PBF	LT6108AHMS8-1#TRPBF	LTfND	8-Lead Plastic MSOP	-40°C to 125°C
LT6108HMS8-1#PBF	LT6108HMS8-1#TRPBF	LTfND	8-Lead Plastic MSOP	-40°C to 125°C
LT6108AIMS8-2#PBF	LT6108AIMS8-2#TRPBF	LTfNG	8-Lead Plastic MSOP	-40°C to 85°C
LT6108IMS8-2#PBF	LT6108IMS8-2#TRPBF	LTfNG	8-Lead Plastic MSOP	-40°C to 85°C
LT6108AHMS8-2#PBF	LT6108AHMS8-2#TRPBF	LTfNG	8-Lead Plastic MSOP	-40°C to 125°C
LT6108HMS8-2#PBF	LT6108HMS8-2#TRPBF	LTfNG	8-Lead Plastic MSOP	-40°C to 125°C

Consult LTC Marketing for parts specified with wider operating temperature ranges. \*The temperature grade is identified by a label on the shipping container. Consult LTC Marketing for information on non-standard lead based finish parts.

For more information on lead free part marking, go to: <http://www.linear.com/leadfree/>

For more information on tape and reel specifications, go to: <http://www.linear.com/tapeandree/>

### Lead Free Finish

TAPE AND REEL (MINI)	TAPE AND REEL	PART MARKING*	PACKAGE DESCRIPTION	SPECIFIED TEMPERATURE RANGE
LT6108IDCB-1#TRMPBF	LT6108IDCB-1#TRPBF	LFNF	8-Lead (2mm × 3mm) Plastic DFN	-40°C to 85°C
LT6108HDCB-1#TRMPBF	LT6108HDCB-1#TRPBF	LFNF	8-Lead (2mm × 3mm) Plastic DFN	-40°C to 125°C
LT6108IDCB-2#TRMPBF	LT6108IDCB-2#TRPBF	LFNH	8-Lead (2mm × 3mm) Plastic DFN	-40°C to 85°C
LT6108HDCB-2#TRMPBF	LT6108HDCB-2#TRPBF	LFNH	8-Lead (2mm × 3mm) Plastic DFN	-40°C to 125°C

TRM = 500 pieces. \*Temperature grades are identified by a label on the shipping container.

Consult LTC Marketing for parts specified with wider operating temperature ranges.

Consult LTC Marketing for information on lead based finish parts.

For more information on lead free part marking, go to: <http://www.linear.com/leadfree/>

For more information on tape and reel specifications, go to: <http://www.linear.com/tapeandree/>

# LT6108-1/LT6108-2

**ELECTRICAL CHARACTERISTICS** The ● denotes the specifications which apply over the full operating temperature range, otherwise specifications are at  $T_A = 25^\circ\text{C}$ .  $V^+ = 12\text{V}$ ,  $V_{\text{PULLUP}} = V^+$ ,  $V_{\text{EN}} = V_{\text{EN/RST}} = 2.7\text{V}$ ,  $R_{\text{IN}} = 100\Omega$ ,  $R_{\text{OUT}} = R_1 + R_2 = 10\text{k}$ , gain = 100,  $R_C = 25.5\text{k}$ ,  $C_L = C_{\text{LC}} = 2\text{pF}$ , unless otherwise noted. (See Figure 3)

SYMBOL	PARAMETER	CONDITIONS	MIN	TYP	MAX	UNITS
$V^+$	Supply Voltage Range		● 2.7		60	V
$I_S$	Supply Current (Note 4)	$V^+ = 2.7\text{V}$ , $R_{\text{IN}} = 1\text{k}$ , $V_{\text{SENSE}} = 5\text{mV}$		450		$\mu\text{A}$
		$V^+ = 60\text{V}$ , $R_{\text{IN}} = 1\text{k}$ , $V_{\text{SENSE}} = 5\text{mV}$	●	550	650 950	$\mu\text{A}$ $\mu\text{A}$
	Supply Current in Shutdown	$V^+ = 2.7\text{V}$ , $V_{\text{EN/RST}} = 0\text{V}$ , $R_{\text{IN}} = 1\text{k}$ , $V_{\text{SENSE}} = 0.5\text{V}$	●	3	5 7	$\mu\text{A}$ $\mu\text{A}$
		$V^+ = 60\text{V}$ , $V_{\text{EN/RST}} = 0\text{V}$ , $R_{\text{IN}} = 1\text{k}$ , $V_{\text{SENSE}} = 0.5\text{V}$	●	7	11 13	$\mu\text{A}$ $\mu\text{A}$
	EN/RST Pin Current	$V_{\text{EN/RST}} = 0\text{V}$ , $V^+ = 60\text{V}$ (LT6108-1 Only)		-200		nA
	EN Pin Current	$V_{\text{EN}} = 0\text{V}$ , $V^+ = 60\text{V}$ (LT6108-2 Only)		-100		nA
$V_{\text{IH}}$	EN/RST Pin Input High	$V^+ = 2.7\text{V}$ to $60\text{V}$ (LT6108-1 Only)	●	1.9		V
$V_{\text{IL}}$	EN/RST Pin Input Low	$V^+ = 2.7\text{V}$ to $60\text{V}$ (LT6108-1 Only)	●		0.8	V
$V_{\text{IH}}$	EN Pin Input High	$V^+ = 2.7\text{V}$ to $60\text{V}$ (LT6108-2 Only)	●	1.9		V
$V_{\text{IL}}$	EN Pin Input Low	$V^+ = 2.7\text{V}$ to $60\text{V}$ (LT6108-2 Only)	●		0.8	V

## Current Sense Amplifier

$V_{\text{OS}}$	Input Offset Voltage	$V_{\text{SENSE}} = 5\text{mV}$ , LT6108A		-125	125	$\mu\text{V}$
		$V_{\text{SENSE}} = 5\text{mV}$ , LT6108		-350	350	$\mu\text{V}$
		$V_{\text{SENSE}} = 5\text{mV}$ , LT6108A	●	-250	250	$\mu\text{V}$
		$V_{\text{SENSE}} = 5\text{mV}$ , LT6108	●	-450	450	$\mu\text{V}$
$\Delta V_{\text{OS}}/\Delta T$	Input Offset Voltage Drift	$V_{\text{SENSE}} = 5\text{mV}$	●	$\pm 0.8$		$\mu\text{V}/^\circ\text{C}$
$I_B$	Input Bias Current (SENSELO, SENSEHI)	$V^+ = 2.7\text{V}$ to $60\text{V}$	●	60	300 350	nA nA
		$V^+ = 2.7\text{V}$ to $60\text{V}$		$\pm 5$		nA
$I_{\text{OS}}$	Input Offset Current	$V^+ = 2.7\text{V}$ to $60\text{V}$		$\pm 5$		nA
$I_{\text{OUTA}}$	Output Current (Note 5)		●	1		mA
PSRR	Power Supply Rejection Ratio (Note 6)	$V^+ = 2.7\text{V}$ to $60\text{V}$	●	120	127	dB
		$V^+ = 2.7\text{V}$ to $60\text{V}$	●	114		dB
CMRR	Common Mode Rejection Ratio	$V^+ = 36\text{V}$ , $V_{\text{SENSE}} = 5\text{mV}$ , $V_{\text{ICM}} = 2.7\text{V}$ to $36\text{V}$		125		dB
		$V^+ = 60\text{V}$ , $V_{\text{SENSE}} = 5\text{mV}$ , $V_{\text{ICM}} = 27\text{V}$ to $60\text{V}$	●	110 103	125	dB dB
$V_{\text{SENSE(MAX)}}$	Full-Scale Input Sense Voltage (Note 5)	$R_{\text{IN}} = 500\Omega$	●	500		mV
		Gain Error (Note 7)			-0.08	%
	SENSELO Voltage (Note 8)	$V^+ = 2.7\text{V}$ to $12\text{V}$	●	-0.2	0	%
		$V^+ = 12\text{V}$ to $60\text{V}$ , $V_{\text{SENSE}} = 5\text{mV}$ to $100\text{mV}$ , MS8 Package	●	-0.3	0	%
		$V^+ = 12\text{V}$ to $60\text{V}$ , $V_{\text{SENSE}} = 5\text{mV}$ to $100\text{mV}$ , DFN Package	●	-0.3	0	%
	Output Swing High ( $V^+$ to $V_{\text{OUTA}}$ )	$V^+ = 2.7\text{V}$ , $V_{\text{SENSE}} = 27\text{mV}$	●		0.2	V
		$V^+ = 12\text{V}$ , $V_{\text{SENSE}} = 120\text{mV}$	●		0.5	V
BW	Signal Bandwidth	$I_{\text{OUT}} = 1\text{mA}$		1		MHz
		$I_{\text{OUT}} = 100\mu\text{A}$		140		kHz
$t_r$	Input Step Response (to 50% of Final Output Voltage)	$V^+ = 2.7\text{V}$ , $V_{\text{SENSE}} = 24\text{mV}$ Step, Output Rising Edge		500		ns
		$V^+ = 12\text{V}$ to $60\text{V}$ , $V_{\text{SENSE}} = 100\text{mV}$ Step, Output Rising Edge		500		ns
$t_{\text{SETTLE}}$	Settling Time to 1%	$V_{\text{SENSE}} = 10\text{mV}$ to $100\text{mV}$ , $R_{\text{OUT}} = 2\text{k}$		2		$\mu\text{s}$

**ELECTRICAL CHARACTERISTICS** The ● denotes the specifications which apply over the full operating temperature range, otherwise specifications are at  $T_A = 25^\circ\text{C}$ .  $V^+ = 12\text{V}$ ,  $V_{\text{PULLUP}} = V^+$ ,  $V_{\text{EN}} = V_{\text{EN}/\text{RST}} = 2.7\text{V}$ ,  $R_{\text{IN}} = 100\Omega$ ,  $R_{\text{OUT}} = R_1 + R_2 = 10\text{k}$ , gain = 100,  $R_C = 25.5\text{k}$ ,  $C_L = C_{\text{LC}} = 2\text{pF}$ , unless otherwise noted. (See Figure 3)

SYMBOL	PARAMETER	CONDITIONS	MIN	TYP	MAX	UNITS	
<b>Reference and Comparator</b>							
$V_{\text{TH(R)}}$ (Note 9)	Rising Input Threshold Voltage	$V^+ = 2.7\text{V}$ to 60V, LT6108A	●	395	400	405	mV
		$V^+ = 2.7\text{V}$ to 60V, LT6108	●	392	400	408	mV
$V_{\text{HYS}}$	$V_{\text{HYS}} = V_{\text{TH(R)}} - V_{\text{TH(F)}}$	$V^+ = 2.7\text{V}$ to 60V		3	10	15	mV
	Comparator Input Bias Current	$V_{\text{INC}} = 0\text{V}$ , $V^+ = 60\text{V}$	●	-50			nA
$V_{\text{OL}}$	Output Low Voltage	$I_{\text{OUTC}} = 500\mu\text{A}$ , $V^+ = 2.7\text{V}$	●		60	150	mV
						220	mV
	High to Low Propagation Delay	5mV Overdrive 100mV Overdrive			3		$\mu\text{s}$
	Output Fall Time				0.5		$\mu\text{s}$
$t_{\text{RESET}}$	Reset Time	LT6108-1 Only			0.08		$\mu\text{s}$
$t_{\text{RPW}}$	Valid $\overline{\text{RST}}$ Pulse Width	LT6108-1 Only	●	2		15	$\mu\text{s}$

**Note 1:** Stresses beyond those listed under Absolute Maximum Ratings may cause permanent damage to the device. Exposure to any Absolute Maximum Rating condition for extended periods may affect device reliability and lifetime.

**Note 2:** Input and output pins have ESD diodes connected to ground. The SENSEHI and SENSELO pins have additional current handling capability specified as SENSEHI, SENSELO Input Current.

**Note 3:** The LT6108I is guaranteed to meet specified performance from  $-40^\circ\text{C}$  to  $85^\circ\text{C}$ . LT6108H is guaranteed to meet specified performance from  $-40^\circ\text{C}$  to  $125^\circ\text{C}$ .

**Note 4:** Supply current is specified with the comparator output high. When the comparator output goes low the supply current will increase by  $75\mu\text{A}$  typically.

**Note 5:** The full-scale input sense voltage and the maximum output current must be considered to achieve the specified performance.

**Note 6:** Supply voltage and input common mode voltage are varied while amplifier input offset voltage is monitored.

**Note 7:** The specified gain error does not include the effect of external resistors  $R_{\text{IN}}$  and  $R_{\text{OUT}}$ . Although gain error is only guaranteed between 12V and 60V, similar performance is expected for  $V^+ < 12\text{V}$ , as well.

**Note 8:** Refer to SENSELO, SENSEHI Range in the Applications Information section for more information.

**Note 9:** The input threshold voltage which causes the output voltage of the comparator to transition from high to low is specified. The input voltage which causes the comparator output to transition from low to high is the magnitude of the difference between the specified threshold and the hysteresis.

# LT6108-1/LT6108-2

**TYPICAL PERFORMANCE CHARACTERISTICS** Performance characteristics taken at  $T_A = 25^\circ\text{C}$ ,  $V^+ = 12\text{V}$ ,  $V_{\text{PULLUP}} = V^+$ ,  $V_{\text{EN}} = V_{\text{EN/RST}} = 2.7\text{V}$ ,  $R_{\text{IN}} = 100\Omega$ ,  $R_{\text{OUT}} = R_1 + R_2 = 10\text{k}$ , gain = 100,  $R_C = 25.5\text{k}$ ,  $C_L = C_{\text{LC}} = 2\text{pF}$ , unless otherwise noted. (See Figure 3)

**Supply Current vs Supply Voltage**

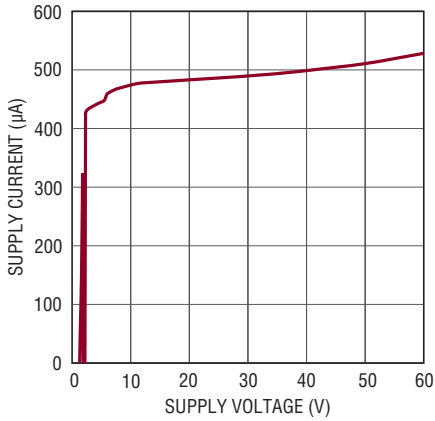

610812 G01

**Start-Up Supply Current**

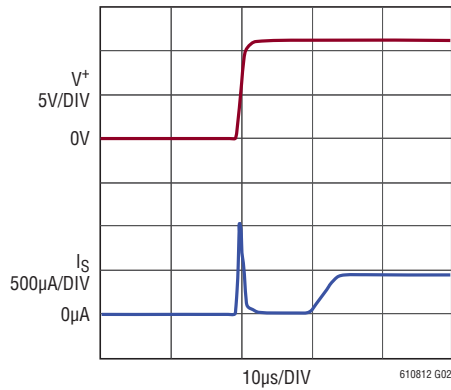

610812 G02

**Enable/Disable Response**

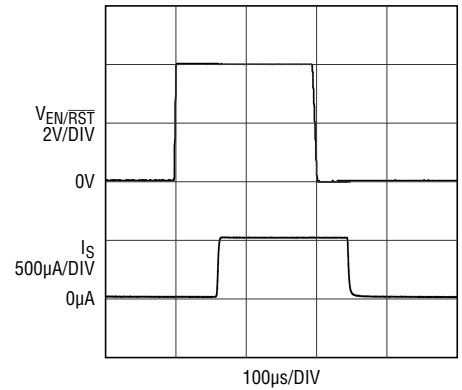

610812 G03

**Input Offset Voltage vs Temperature**

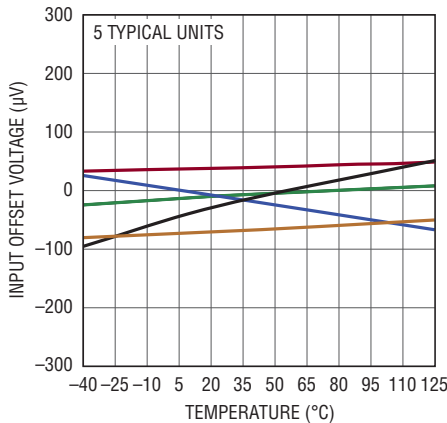

610812 G04

**Amplifier Offset Voltage vs Supply Voltage**

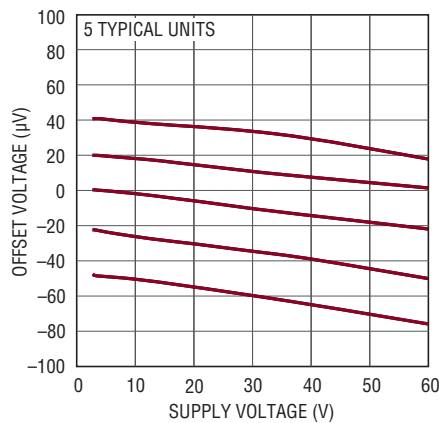

610812 G05

**Offset Voltage Drift Distribution**

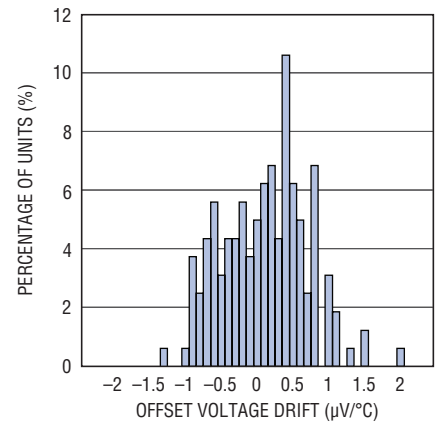

610812 G08

**Amplifier Gain Error vs Temperature**

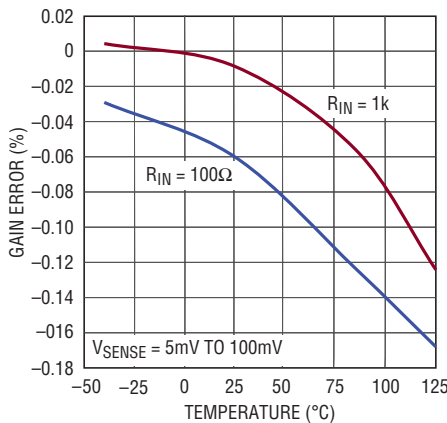

610812 G06

**Amplifier Gain Error Distribution**

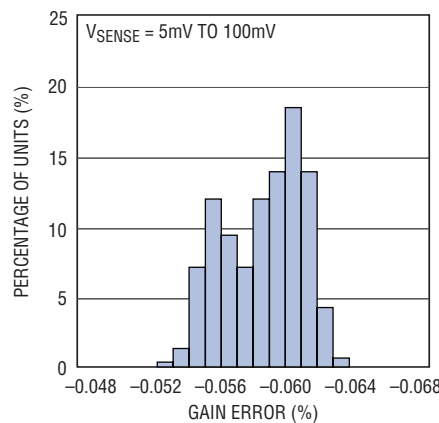

610812 G07

**Amplifier Output Swing vs Temperature**

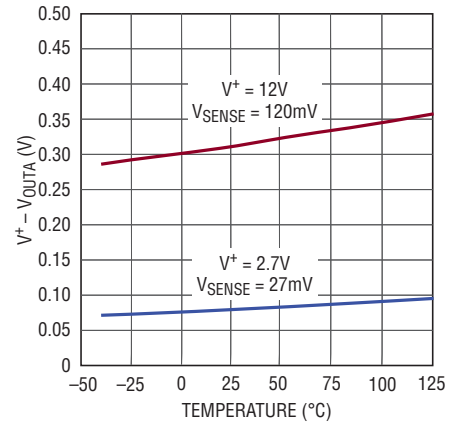

610812 G18

610812fa

**TYPICAL PERFORMANCE CHARACTERISTICS** Performance characteristics taken at  $T_A = 25^\circ\text{C}$ ,  $V^+ = 12\text{V}$ ,  $V_{\text{PULLUP}} = V^+$ ,  $V_{\text{EN}} = V_{\text{EN/RST}} = 2.7\text{V}$ ,  $R_{\text{IN}} = 100\Omega$ ,  $R_{\text{OUT}} = R_1 + R_2 = 10\text{k}$ , gain = 100,  $R_C = 25.5\text{k}$ ,  $C_L = C_{LC} = 2\text{pF}$ , unless otherwise noted. (See Figure 3)

**Common Mode Rejection Ratio vs Frequency**

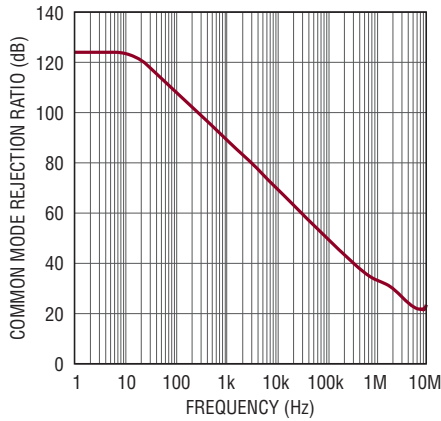

610812 G09

**Amplifier Gain vs Frequency**

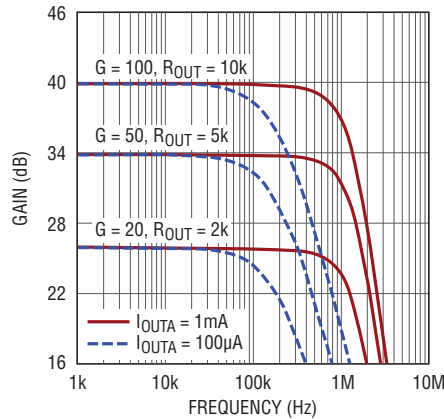

610812 G10

**LT6108-1 Step Response**

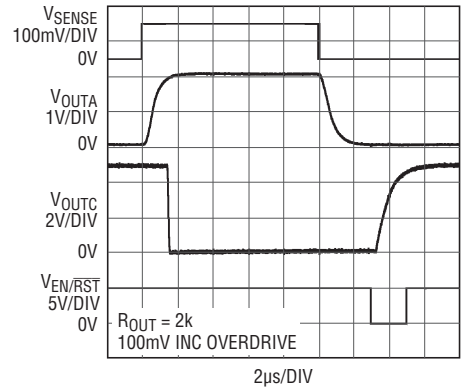

610812 G11

**LT6108-2 Step Response**

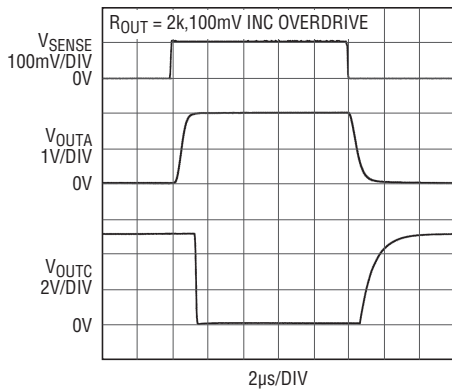

610812 G12

**Amplifier Input Bias Current vs Temperature**

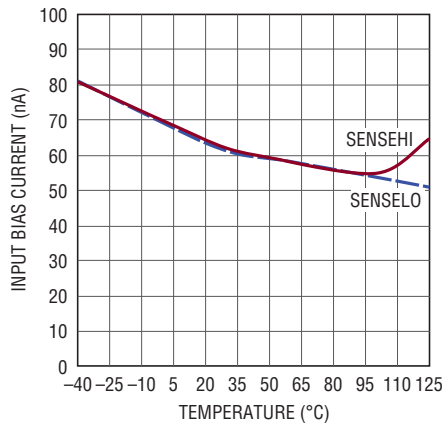

610812 G13

**Amplifier Step Response ( $V_{\text{SENSE}} = 0\text{mV}$  to  $100\text{mV}$ )**

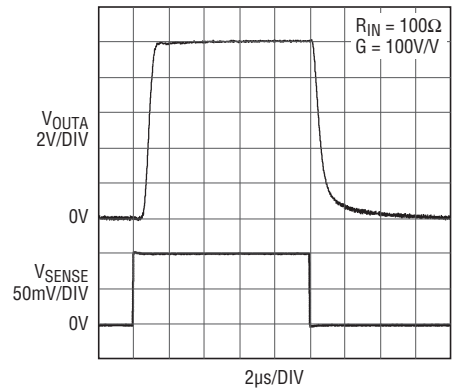

610812 G14

**Amplifier Step Response ( $V_{\text{SENSE}} = 10\text{mV}$  to  $100\text{mV}$ )**

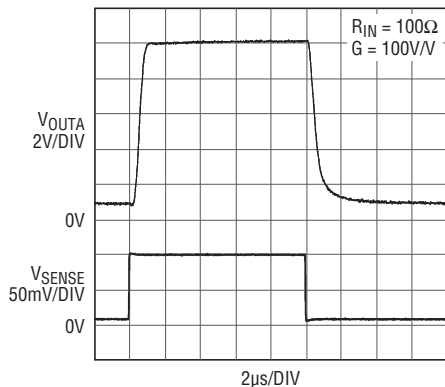

610812 G15

**Amplifier Step Response ( $V_{\text{SENSE}} = 0\text{mV}$  to  $100\text{mV}$ )**

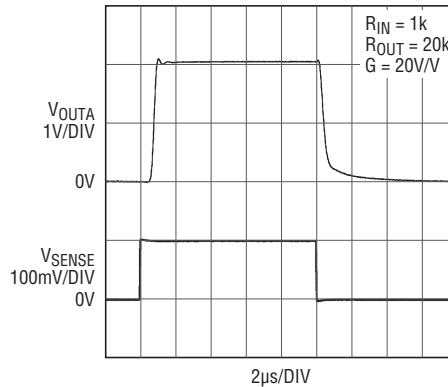

610812 G16

**Amplifier Step Response ( $V_{\text{SENSE}} = 10\text{mV}$  to  $100\text{mV}$ )**

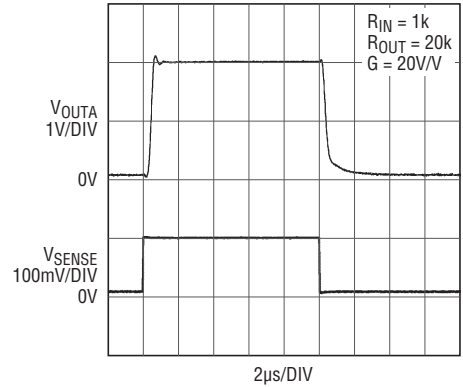

610812 G17

610812fa

# LT6108-1/LT6108-2

**TYPICAL PERFORMANCE CHARACTERISTICS** Performance characteristics taken at  $T_A = 25^\circ\text{C}$ ,  $V^+ = 12\text{V}$ ,  $V_{\text{PULLUP}} = V^+$ ,  $V_{\text{EN}} = V_{\text{EN/RST}} = 2.7\text{V}$ ,  $R_{\text{IN}} = 100\Omega$ ,  $R_{\text{OUT}} = R_1 + R_2 = 10\text{k}$ , gain = 100,  $R_C = 25.5\text{k}$ ,  $C_L = C_{\text{LC}} = 2\text{pF}$ , unless otherwise noted. (See Figure 3)

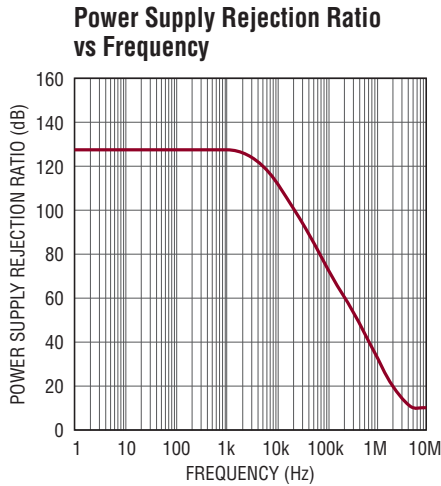

610812 G08

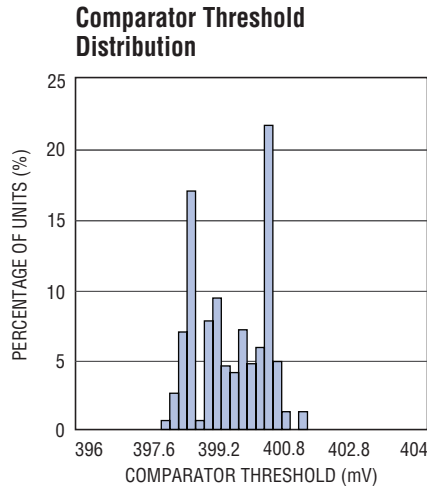

610812 G19

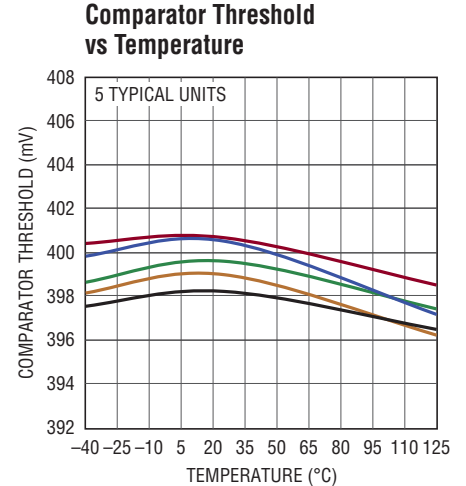

610812 G20

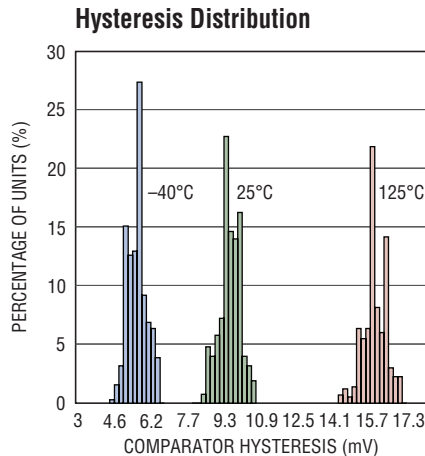

610812 G21

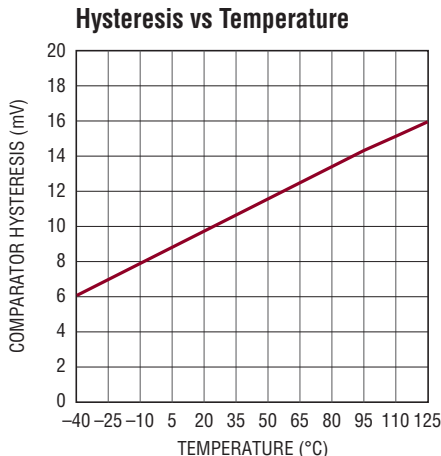

610812 G22

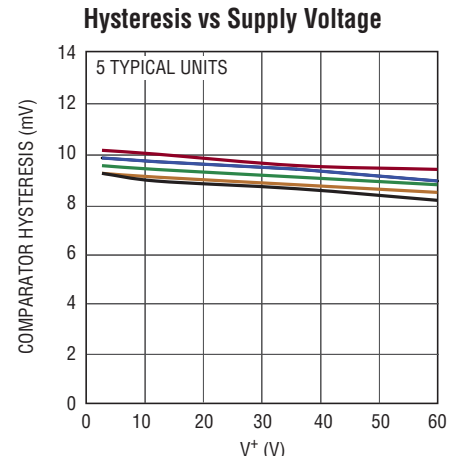

610812 G23

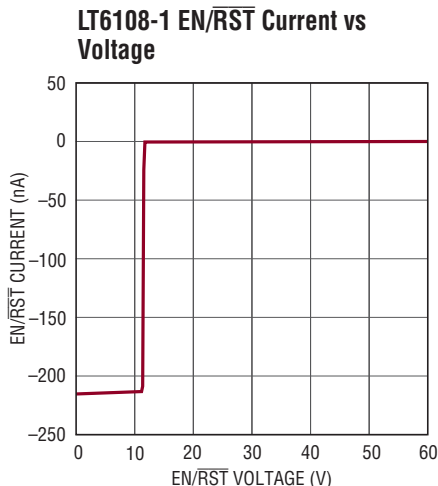

610812 G24

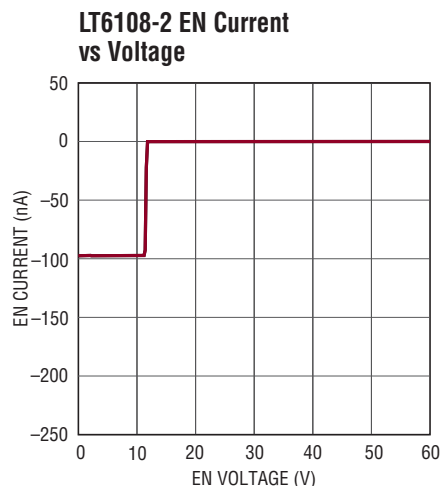

610812 G25



**TYPICAL PERFORMANCE CHARACTERISTICS** Performance characteristics taken at  $T_A = 25^\circ\text{C}$ ,  $V^+ = 12\text{V}$ ,  $V_{\text{PULLUP}} = V^+$ ,  $V_{\text{EN}} = V_{\text{EN/RST}} = 2.7\text{V}$ ,  $R_{\text{IN}} = 100\Omega$ ,  $R_{\text{OUT}} = R1 + R2 = 10\text{k}$ , gain = 100,  $R_C = 25.5\text{k}$ ,  $C_L = C_{LC} = 2\text{pF}$ , unless otherwise noted. (See Figure 3)

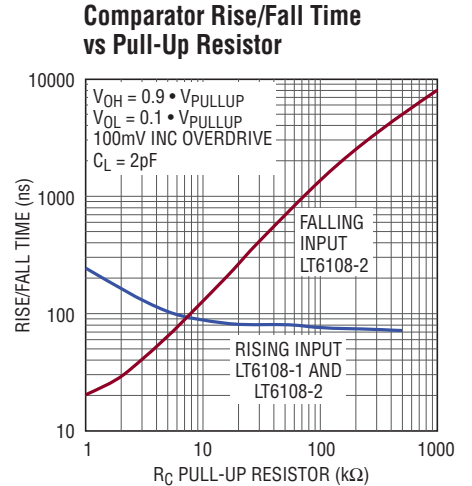
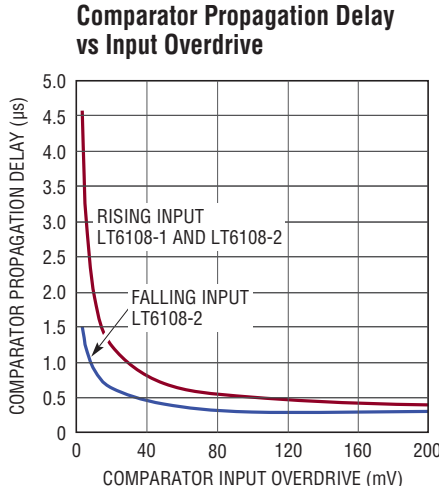
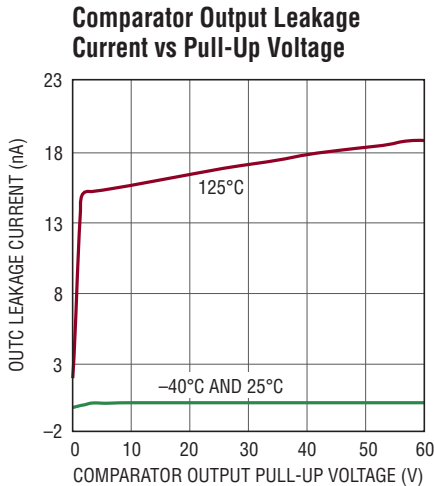
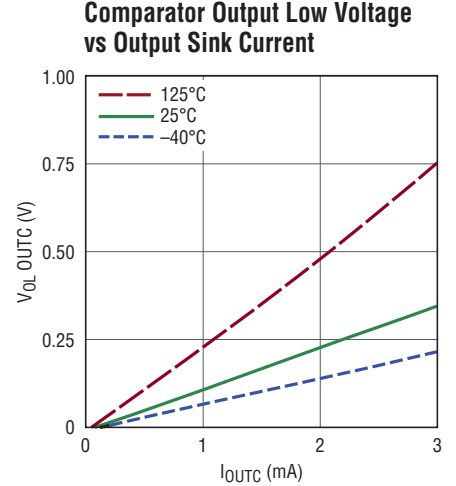
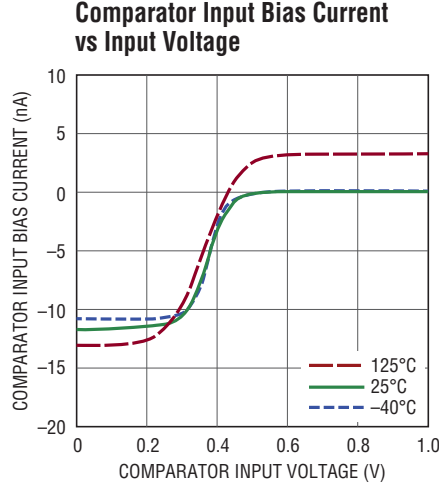
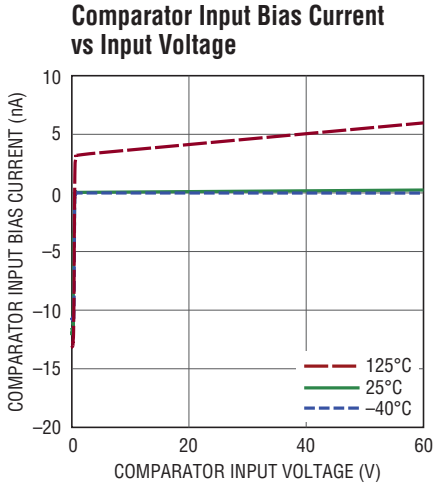

**LT6108-1 Comparator Step Response (5mV INC Overdrive)**

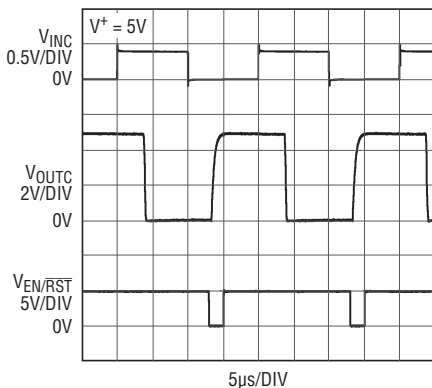

**LT6108-1 Comparator Step Response (100mV INC Overdrive)**

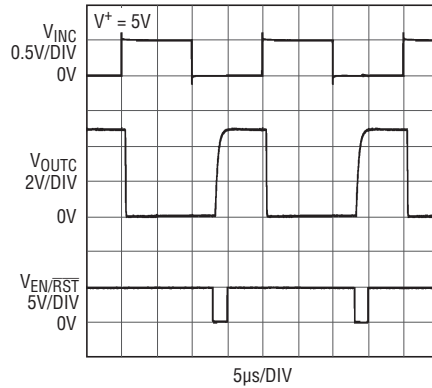

**TYPICAL PERFORMANCE CHARACTERISTICS** Performance characteristics taken at  $T_A = 25^\circ\text{C}$ ,  $V^+ = 12\text{V}$ ,  $V_{\text{PULLUP}} = V^+$ ,  $V_{\text{EN}} = V_{\text{EN}/\text{RST}} = 2.7\text{V}$ ,  $R_{\text{IN}} = 100\Omega$ ,  $R_{\text{OUT}} = R1 + R2 = 10\text{k}$ , gain = 100,  $R_C = 25.5\text{k}$ ,  $C_L = C_{\text{LC}} = 2\text{pF}$ , unless otherwise noted. (See Figure 3)

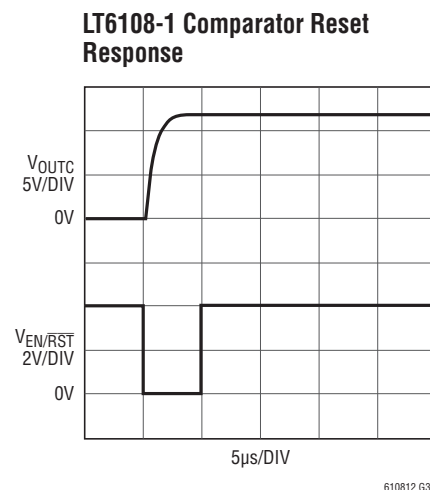
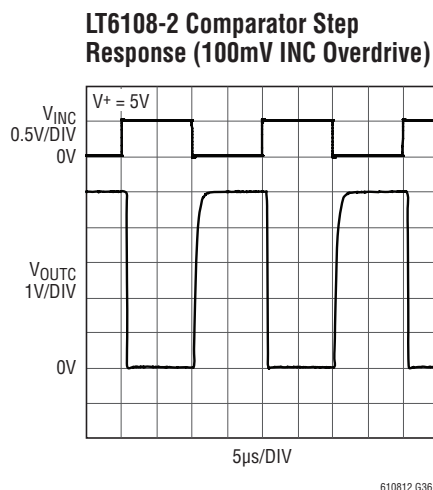
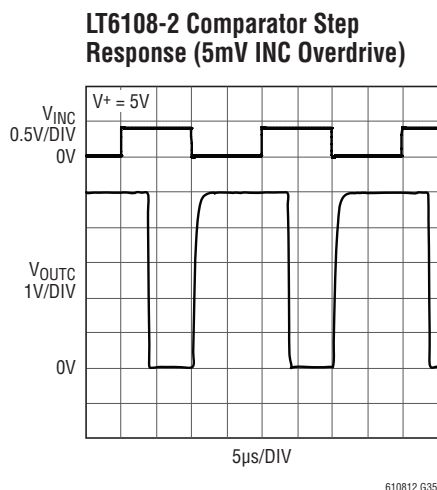

## PIN FUNCTIONS

**SENSELO (Pin 1):** Sense Amplifier Input. This pin must be tied to the load end of the sense resistor.

**EN/ $\overline{\text{RST}}$  (Pin 2, LT6108-1 Only):** Enable and Latch Reset Input. When the EN/ $\overline{\text{RST}}$  pin is pulled high the LT6108-1 is enabled. When the EN/ $\overline{\text{RST}}$  pin is pulled low for longer than typically  $40\mu\text{s}$ , the LT6108-1 will enter the shutdown mode. Pulsing this pin low for between  $2\mu\text{s}$  and  $15\mu\text{s}$  will reset the comparator of the LT6108-1.

**EN (Pin 2, LT6108-2 Only):** Enable Input. When the enable pin is pulled high the LT6108-2 is enabled. When the enable pin is pulled low for longer than typically  $40\mu\text{s}$ , the LT6108-2 will enter the shutdown mode.

**OUTC (Pin 3):** Open-Drain Comparator Output. Off-state voltage may be as high as 60V above  $V^-$ , regardless of  $V^+$  used.

**$V^-$  (Pin 4):** Negative Supply Pin. This pin is normally connected to ground.

**INC (Pin 5):** This is the inverting input of the comparator. The other comparator input is internally connected to the 400mV reference.

**OUTA (Pin 6):** Current Output of the Sense Amplifier. This pin will source a current that is equal to the sense voltage divided by the external gain setting resistor,  $R_{\text{IN}}$ .

**$V^+$  (Pin 7):** Positive Supply Pin. The  $V^+$  pin can be connected directly to either side of the sense resistor,  $R_{\text{SENSE}}$ . When  $V^+$  is tied to the load end of the sense resistor, the SENSEHI pin can go up to 0.2V above  $V^+$ . Supply current is drawn through this pin.

**SENSEHI (Pin 8):** Sense Amplifier Input. The internal sense amplifier will drive SENSEHI to the same potential as SENSELO. A resistor (typically  $R_{\text{IN}}$ ) tied from supply to SENSEHI sets the output current,  $I_{\text{OUT}} = V_{\text{SENSE}}/R_{\text{IN}}$ , where  $V_{\text{SENSE}}$  is the voltage developed across  $R_{\text{SENSE}}$ .

**Exposed Pad (Pin 9, DCB Package Only):**  $V^-$ . The exposed pad may be left open or connected to device  $V^-$ . Connecting the exposed pad to a  $V^-$  plane will improve thermal management in high voltage applications. The exposed pad should not be used as the primary connection for  $V^-$ .

**BLOCK DIAGRAMS**

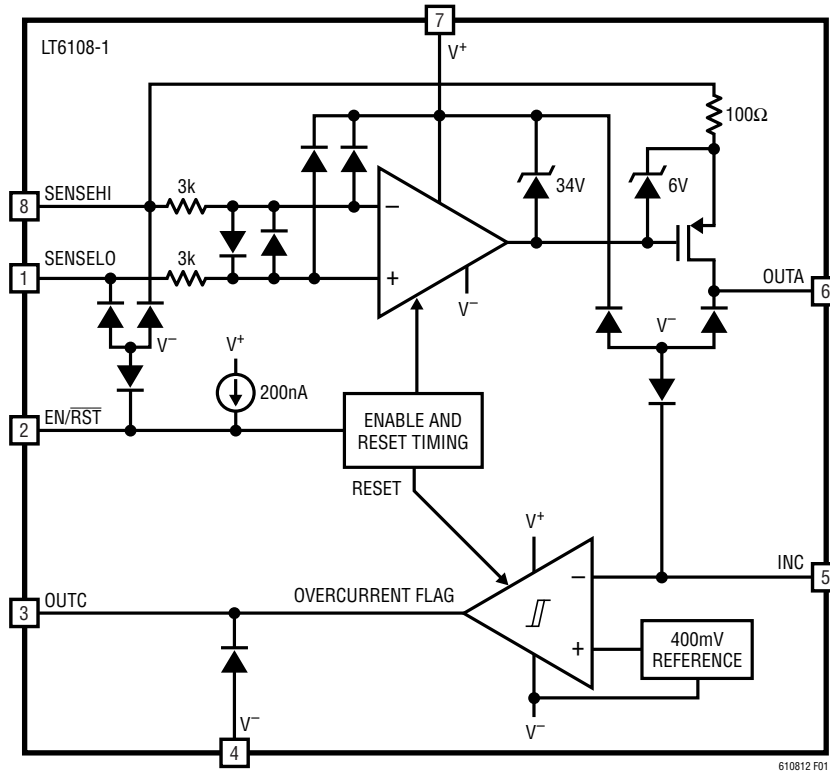

Figure 1. LT6108-1 Block Diagram (Latching Comparator)

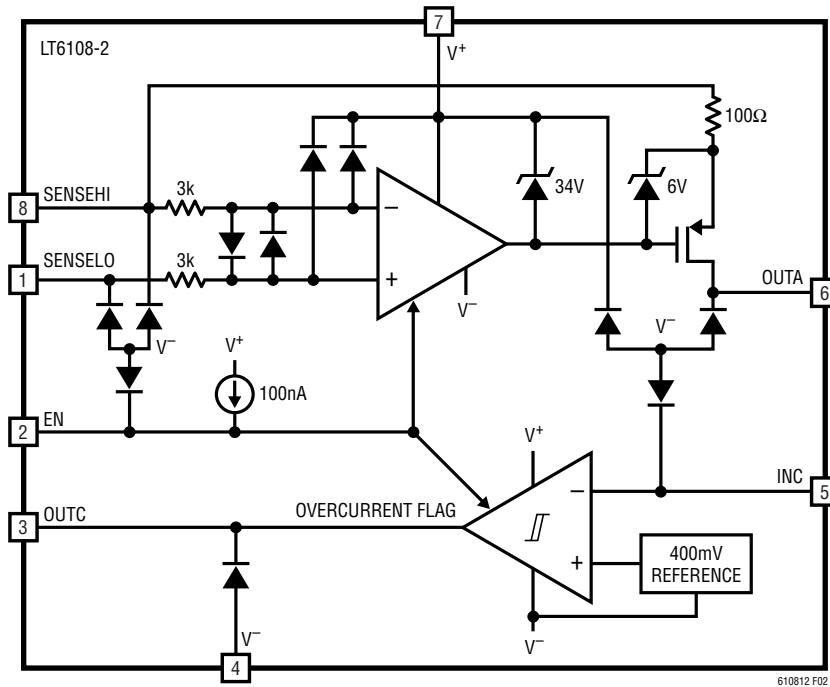

Figure 2. LT6108-2 Block Diagram (Non-Latching Comparator)

## APPLICATIONS INFORMATION

The LT6108 high side current sense amplifier provides accurate monitoring of currents through an external sense resistor. The input sense voltage is level-shifted from the sensed power supply to a ground referenced output and is amplified by a user-selected gain to the output. The output voltage is directly proportional to the current flowing through the sense resistor.

The LT6108 comparator has a threshold set with a built-in 400mV precision reference and has 10mV of hysteresis. The open-drain output can be easily used to level shift to digital supplies.

### Amplifier Theory of Operation

An internal sense amplifier loop forces SENSEHI to have the same potential as SENSELO as shown in Figure 3. Connecting an external resistor,  $R_{IN}$ , between SENSEHI and  $V_{SUPPLY}$  forces a potential,  $V_{SENSE}$ , across  $R_{IN}$ . A corresponding current,  $I_{OUTA}$ , equal to  $V_{SENSE}/R_{IN}$ , will flow through  $R_{IN}$ . The high impedance inputs of the sense amplifier do not load this current, so it will flow through an internal MOSFET to the output pin, OUTA.

The output current can be transformed back into a voltage by adding a resistor from OUTA to  $V^-$  (typically ground). The output voltage is then:

$$V_{OUT} = V^- + I_{OUTA} \cdot R_{OUT}$$

where  $R_{OUT} = R_1 + R_2$  as shown in Figure 3.

**Table 1. Example Gain Configurations**

GAIN	$R_{IN}$	$R_{OUT}$	$V_{SENSE}$ FOR $V_{OUT} = 5V$	$I_{OUTA}$ AT $V_{OUT} = 5V$
20	499 $\Omega$	10k	250mV	500 $\mu$ A
50	200 $\Omega$	10k	100mV	500 $\mu$ A
100	100 $\Omega$	10k	50mV	500 $\mu$ A

### Useful Equations

Input Voltage:  $V_{SENSE} = I_{SENSE} \cdot R_{SENSE}$

Voltage Gain:  $\frac{V_{OUT}}{V_{SENSE}} = \frac{R_{OUT}}{R_{IN}}$

Current Gain:  $\frac{I_{OUTA}}{I_{SENSE}} = \frac{R_{SENSE}}{R_{IN}}$

Note that  $V_{SENSE(MAX)}$  can be exceeded without damaging the amplifier, however, output accuracy will degrade as  $V_{SENSE}$  exceeds  $V_{SENSE(MAX)}$ , resulting in increased output current,  $I_{OUTA}$ .

### Selection of External Current Sense Resistor

The external sense resistor,  $R_{SENSE}$ , has a significant effect on the function of a current sensing system and must be chosen with care.

First, the power dissipation in the resistor should be considered. The measured load current will cause power dissipation as well as a voltage drop in  $R_{SENSE}$ . As a result, the sense resistor should be as small as possible while still providing the input dynamic range required by the measurement. Note that the input dynamic range is the difference between the maximum input signal and the minimum accurately reproduced signal, and is limited primarily by input DC offset of the internal sense amplifier of the LT6108. To ensure the specified performance,  $R_{SENSE}$  should be small enough that  $V_{SENSE}$  does not exceed  $V_{SENSE(MAX)}$  under peak load conditions. As an example, an application may require the maximum sense voltage be 100mV. If this application is expected to draw 2A at peak load,  $R_{SENSE}$  should be set to 50m $\Omega$ .

Once the maximum  $R_{SENSE}$  value is determined, the minimum sense resistor value will be set by the resolution or dynamic range required. The minimum signal that can be accurately represented by this sense amplifier is limited by the input offset. As an example, the LT6108 has a maximum input offset of 125 $\mu$ V. If the minimum current is 20mA, a sense resistor of 6.25m $\Omega$  will set  $V_{SENSE}$  to 125 $\mu$ V. This is the same value as the input offset. A larger sense resistor will reduce the error due to offset by increasing the sense voltage for a given load current. Choosing a 50m $\Omega$   $R_{SENSE}$  will maximize the dynamic range and provide a system that has 100mV across the sense resistor at peak load (2A), while input offset causes an error equivalent to only 2.5mA of load current.

In the previous example, the peak dissipation in  $R_{SENSE}$  is 200mW. If a 5m $\Omega$  sense resistor is employed, then the effective current error is 25mA, while the peak sense voltage is reduced to 10mV at 2A, dissipating only 20mW.

## APPLICATIONS INFORMATION

The low offset and corresponding large dynamic range of the LT6108 make it more flexible than other solutions in this respect. The 125 $\mu$ V maximum offset gives 72dB of dynamic range for a sense voltage that is limited to 500mV max.

### Sense Resistor Connection

Kelvin connection of the SENSEHI and SENSELO inputs to the sense resistor should be used in all but the lowest power applications. Solder connections and PC board interconnections that carry high currents can cause significant error in measurement due to their relatively large resistances. One 10mm  $\times$  10mm square trace of 1oz copper is approximately 0.5m $\Omega$ . A 1mV error can be caused by as little as 2A flowing through this small interconnect. This will cause a 1% error for a full-scale  $V_{SENSE}$  of 100mV. A 10A load current in the same interconnect will cause a 5% error for the same 100mV signal. By isolating the sense traces from the high current paths, this error can be reduced by orders of magnitude. A sense resistor with integrated Kelvin sense terminals will give the best results. Figure 3 illustrates the recommended method for connecting the SENSEHI and SENSELO pins to the sense resistor.

### Selection of External Input Gain Resistor, $R_{IN}$

$R_{IN}$  should be chosen to allow the required speed and resolution while limiting the output current to 1mA. The maximum value for  $R_{IN}$  is 1k to maintain good loop stability. For a given  $V_{SENSE}$ , larger values of  $R_{IN}$  will lower power dissipation in the LT6108 due to the reduction in  $I_{OUT}$  while smaller values of  $R_{IN}$  will result in faster response time due to the increase in  $I_{OUT}$ . If low sense currents must be resolved accurately in a system that has a very wide dynamic range, a smaller  $R_{IN}$  may be used if the maximum  $I_{OUTA}$  current is limited in another way, such as with a Schottky diode across  $R_{SENSE}$  (Figure 4). This will reduce the high current measurement accuracy by limiting the result, while increasing the low current measurement resolution.

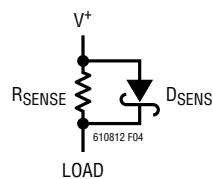

Figure 4. Shunt Diode Limits Maximum Input Voltage to Allow Better Low Input Resolution Without Overranging

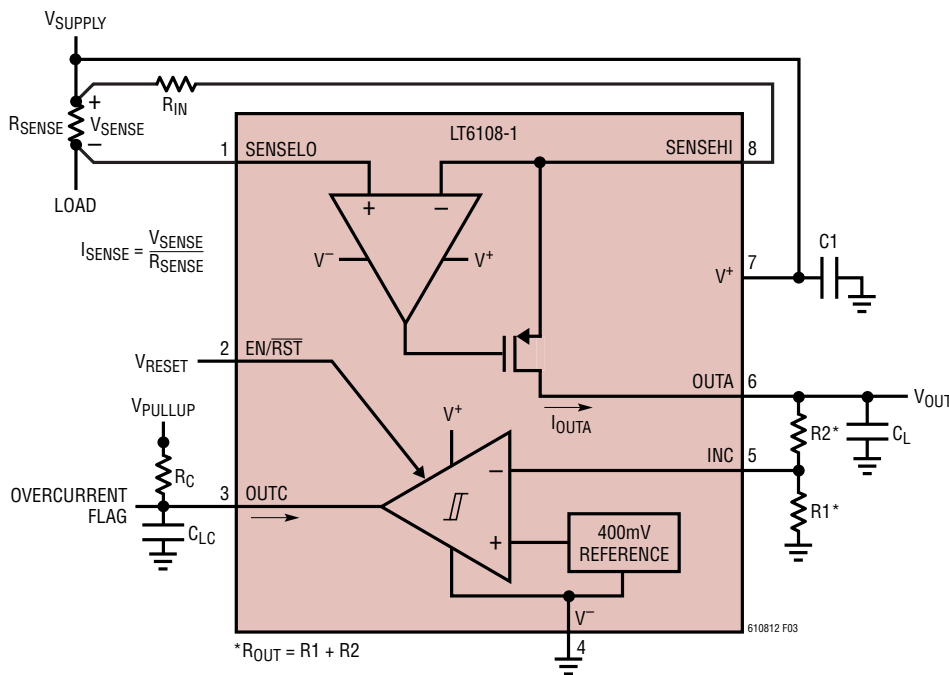

Figure 3. LT6108-1 Typical Connection

## APPLICATIONS INFORMATION

This approach can be helpful in cases where occasional bursts of high currents can be ignored.

Care should be taken when designing the board layout for  $R_{IN}$ , especially for small  $R_{IN}$  values. All trace and interconnect resistances will increase the effective  $R_{IN}$  value, causing a gain error.

The power dissipated in the sense resistor can create a thermal gradient across a printed circuit board and consequently a gain error if  $R_{IN}$  and  $R_{OUT}$  are placed such that they operate at different temperatures. If significant power is being dissipated in the sense resistor then care should be taken to place  $R_{IN}$  and  $R_{OUT}$  such that the gain error due to the thermal gradient is minimized.

### Selection of External Output Gain Resistor, $R_{OUT}$

The output resistor,  $R_{OUT}$ , determines how the output current is converted to voltage.  $V_{OUT}$  is simply  $I_{OUTA} \cdot R_{OUT}$ . Typically,  $R_{OUT}$  is a combination of resistors configured as a resistor divider which has a voltage tap going to the comparator input to set the comparator threshold.

In choosing an output resistor, the maximum output voltage must first be considered. If the subsequent circuit is a buffer or ADC with limited input range, then  $R_{OUT}$  must be chosen so that  $I_{OUTA(MAX)} \cdot R_{OUT}$  is less than the allowed maximum input range of this circuit.

In addition, the output impedance is determined by  $R_{OUT}$ . If another circuit is being driven, then the input impedance of that circuit must be considered. If the subsequent circuit has high enough input impedance, then almost any useful output impedance will be acceptable. However, if the subsequent circuit has relatively low input impedance, or draws spikes of current such as an ADC load, then a lower output impedance may be required to preserve the accuracy of the output. More information can be found in the Output Filtering section. As an example, if the input impedance of the driven circuit,  $R_{IN(DRIVEN)}$ , is 100 times  $R_{OUT}$ , then the accuracy of  $V_{OUT}$  will be reduced by 1% since:

$$\begin{aligned} V_{OUT} &= I_{OUTA} \cdot \frac{R_{OUT} \cdot R_{IN(DRIVEN)}}{R_{OUT} + R_{IN(DRIVEN)}} \\ &= I_{OUTA} \cdot R_{OUT} \cdot \frac{100}{101} = 0.99 \cdot I_{OUTA} \cdot R_{OUT} \end{aligned}$$

### Amplifier Error Sources

The current sense system uses an amplifier and resistors to apply gain and level-shift the result. Consequently, the output is dependent on the characteristics of the amplifier, such as gain error and input offset, as well as the matching of the external resistors.

Ideally, the circuit output is:

$$V_{OUT} = V_{SENSE} \cdot \frac{R_{OUT}}{R_{IN}}; V_{SENSE} = R_{SENSE} \cdot I_{SENSE}$$

In this case, the only error is due to external resistor mismatch, which provides an error in gain only. However, offset voltage, input bias current and finite gain in the amplifier can cause additional errors:

### Output Voltage Error, $\Delta V_{OUT(VOS)}$ , Due to the Amplifier DC Offset Voltage, $V_{OS}$

$$\Delta V_{OUT(VOS)} = V_{OS} \cdot \frac{R_{OUT}}{R_{IN}}$$

The DC offset voltage of the amplifier adds directly to the value of the sense voltage,  $V_{SENSE}$ . As  $V_{SENSE}$  is increased, accuracy improves. This is the dominant error of the system and it limits the available dynamic range.

### Output Voltage Error, $\Delta V_{OUT(IBIAS)}$ , Due to the Bias Currents $I_B^+$ and $I_B^-$

The amplifier bias current  $I_B^+$  flows into the SENSELO pin while  $I_B^-$  flows into the SENSEHI pin. The error due to  $I_B$  is the following:

$$\Delta V_{OUT(IBIAS)} = R_{OUT} \left( I_B^+ \cdot \frac{R_{SENSE}}{R_{IN}} - I_B^- \right)$$

Since  $I_B^+ \approx I_B^- = I_{BIAS}$ , if  $R_{SENSE} \ll R_{IN}$  then,

$$\Delta V_{OUT(IBIAS)} = -R_{OUT} (I_{BIAS})$$

It is useful to refer the error to the input:

$$\Delta V_{VIN(IBIAS)} = -R_{IN} (I_{BIAS})$$

For instance, if  $I_{BIAS}$  is 100nA and  $R_{IN}$  is 1k, the input referred error is 100μV. This error becomes less significant as the value of  $R_{IN}$  decreases. The bias current error can

## APPLICATIONS INFORMATION

be reduced if an external resistor,  $R_{IN}^+$ , is connected as shown in Figure 5, the error is then reduced to:

$$V_{OUT(IBIAS)} = \pm R_{OUT} \cdot I_{OS}; I_{OS} = I_B^+ - I_B^-$$

Minimizing low current errors will maximize the dynamic range of the circuit.

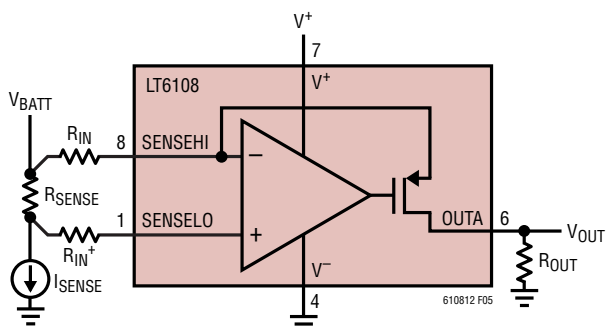

Figure 5.  $R_{IN}^+$  Reduces Error Due to  $I_B$

### Output Voltage Error, $\Delta V_{OUT(GAIN ERROR)}$ , Due to External Resistors

The LT6108 exhibits a very low gain error. As a result, the gain error is only significant when low tolerance resistors are used to set the gain. Note the gain error is systematically negative. For instance, if 0.1% resistors are used for  $R_{IN}$  and  $R_{OUT}$  then the resulting worst-case gain error is  $-0.4\%$  with  $R_{IN} = 100\Omega$ . Figure 6 is a graph of the maximum gain error which can be expected versus the external resistor tolerance.

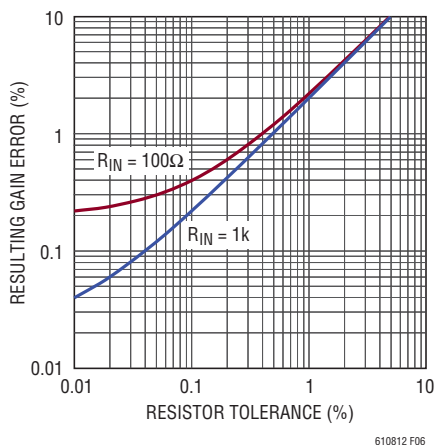

Figure 6. Gain Error vs Resistor Tolerance

### Output Current Limitations Due to Power Dissipation

The LT6108 can deliver a continuous current of 1mA to the OUTA pin. This current flows through  $R_{IN}$  and enters the current sense amplifier via the SENSEHI pin. The power dissipated in the LT6108 due to the output signal is:

$$P_{OUT} = (V_{SENSEHI} - V_{OUTA}) \cdot I_{OUTA}$$

$$\text{Since } V_{SENSEHI} \approx V^+, P_{OUTA} \approx (V^+ - V_{OUTA}) \cdot I_{OUTA}$$

There is also power dissipated due to the quiescent power supply current:

$$P_S = I_S \cdot V^+$$

The comparator output current flows into the comparator output pin and out of the  $V^-$  pin. The power dissipated in the LT6108 due to the comparator is often insignificant and can be calculated as follows:

$$P_{OUTC} = (V_{OUTC} - V^-) \cdot I_{OUTC}$$

The total power dissipated is the sum of these dissipations:

$$P_{TOTAL} = P_{OUTA} + P_{OUTC} + P_S$$

At maximum supply and maximum output currents, the total power dissipation can exceed 150mW. This will cause significant heating of the LT6108 die. In order to prevent damage to the LT6108, the maximum expected dissipation in each application should be calculated. This number can be multiplied by the  $\theta_{JA}$  value,  $163^\circ\text{C/W}$  for the MS8 package or  $64^\circ\text{C/W}$  for the DFN, to find the maximum expected die temperature. Proper heat sinking and thermal relief should be used to ensure that the die temperature does not exceed the maximum rating.

### Output Filtering

The AC output voltage,  $V_{OUT}$ , is simply  $I_{OUTA} \cdot Z_{OUT}$ . This makes filtering straightforward. Any circuit may be used which generates the required  $Z_{OUT}$  to get the desired filter response. For example, a capacitor in parallel with  $R_{OUT}$  will give a lowpass response. This will reduce noise at the output, and may also be useful as a charge reservoir to keep the output steady while driving a switching circuit



## APPLICATIONS INFORMATION

such as a MUX or ADC. This output capacitor in parallel with  $R_{OUT}$  will create an output pole at:

$$f_{-3dB} = \frac{1}{2 \cdot \pi \cdot R_{OUT} \cdot C_L}$$

### SENSELO, SENSEHI Range

The difference between  $V_{BATT}$  (see Figure 7) and  $V^+$ , as well as the maximum value of  $V_{SENSE}$ , must be considered to ensure that the SENSELO pin doesn't exceed the range listed in the Electrical Characteristics table. The SENSELO and SENSEHI pins of the LT6108 can function from 0.2V above the positive supply to 33V below it. These operating voltages are limited by internal diode clamps shown in Figures 1 and 2. On supplies less than 35.5V, the lower range is limited by  $V^- + 2.5V$ . This allows the monitored supply,  $V_{BATT}$ , to be separate from the LT6108 positive supply as shown in Figure 7. Figure 8 shows the range of operating voltages for the SENSELO and SENSEHI inputs, for different supply voltage inputs ( $V^+$ ). The SENSELO and SENSEHI range has been designed to allow the LT6108 to monitor its own supply current (in addition to the load), as long as  $V_{SENSE}$  is less than 200mV. This is shown in Figure 9.

### Minimum Output Voltage

The output of the LT6108 current sense amplifier can produce a non-zero output voltage when the sense voltage is zero. This is a result of the sense amplifier  $V_{OS}$  being forced across  $R_{IN}$  as discussed in the Output Voltage Error,  $\Delta V_{OUT(V_{OS})}$  section. Figure 10 shows the effect of the input offset voltage on the transfer function for parts at the  $V_{OS}$  limits. With a negative offset voltage, zero input

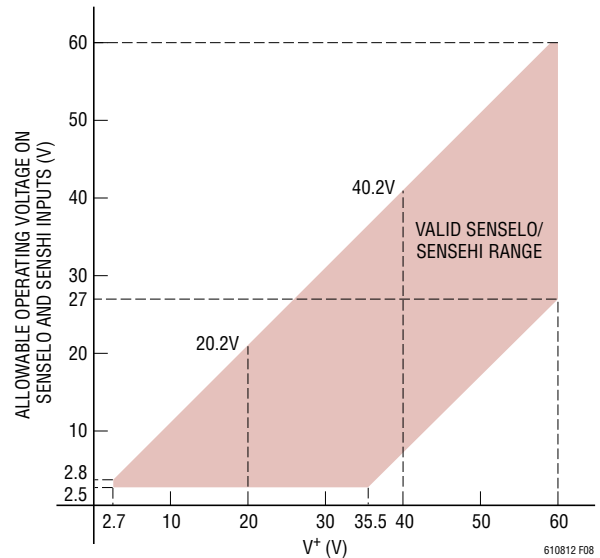

Figure 8. Allowable SENSELO, SENSEHI Voltage Range

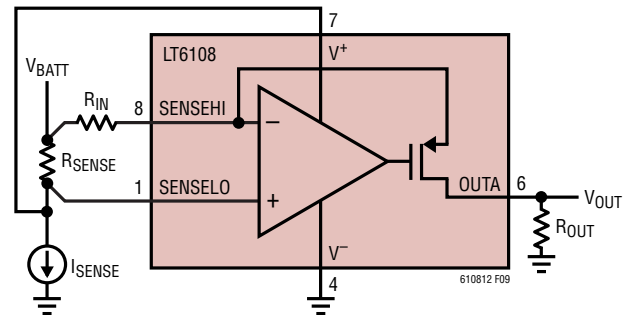

Figure 9. LT6108 Supply Current Monitored with Load

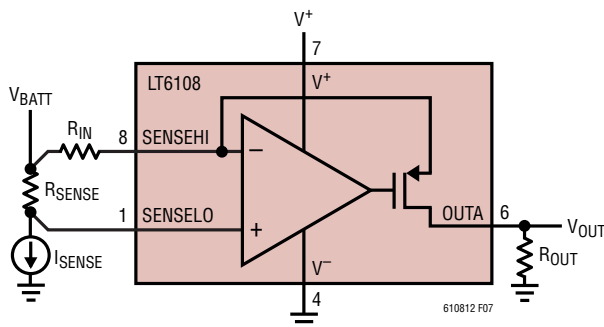

Figure 7.  $V^+$  Powered Separately from Load Supply ( $V_{BATT}$ )

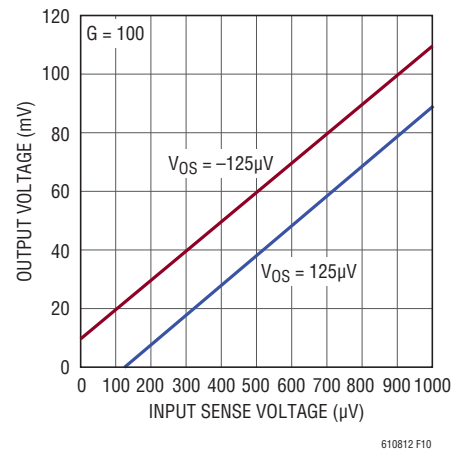

Figure 10. Amplifier Output Voltage vs Input Sense Voltage



## APPLICATIONS INFORMATION

sense voltage produces an output voltage. With a positive offset voltage, the output voltage is zero until the input sense voltage exceeds the input offset voltage. Neglecting  $V_{OS}$ , the output circuit is not limited by saturation of pull-down circuitry and can reach 0V.

### Response Time

The LT6108 amplifier is designed to exhibit fast response to inputs for the purpose of circuit protection or current monitoring. This response time will be affected by the external components in two ways, delay and speed.

If the output current is very low and an input transient occurs, there may be an increased delay before the output voltage begins to change. The Typical Performance Characteristics show that this delay is short and it can be improved by increasing the minimum output current, either by increasing  $R_{SENSE}$  or decreasing  $R_{IN}$ . Note that the Typical Performance Characteristics are labeled with respect to the initial sense voltage.

The speed is also affected by the external components. Using a larger  $R_{OUT}$  will decrease the response time, since  $V_{OUT} = I_{OUTA} \cdot Z_{OUT}$  where  $Z_{OUT}$  is the parallel combination of  $R_{OUT}$  and any parasitic and/or load capacitance. Note that reducing  $R_{IN}$  or increasing  $R_{OUT}$  will both have the effect of increasing the voltage gain of the circuit. If the output capacitance is limiting the speed of the system,  $R_{IN}$  and  $R_{OUT}$  can be decreased together in order to maintain the desired gain and provide more current to charge the output capacitance.

The response time of the comparator is the sum of the propagation delay and the fall time. The propagation delay is a function of the overdrive voltage on the input of the comparator. A larger overdrive will result in a lower propagation delay. This helps achieve a fast system response time to fault events. The fall time is affected by the load on the output of the comparator as well as the pull-up voltage.

The LT6108 amplifier has a typical response time of 500ns and the comparators have a typical response time of 500ns. When configured as a system, the amplifier output drives the comparator input causing a total system response time which is typically greater than that implied by the individually specified response times. This is due to the

overdrive on the comparator input being determined by the speed of the amplifier output.

### Internal Reference and Comparator

The integrated precision reference and comparator combined with the high precision current sense allow for rapid and easy detection of abnormal load currents. This is often critical in systems that require high levels of safety and reliability. The LT6108-1 comparator is optimized for fault detection and is designed with a latching output. The latching output prevents faults from clearing themselves and requires a separate system or user to reset the output. In applications where the comparator output can intervene and disconnect loads from the supply, a latched output is required to avoid oscillation. The latching output is also useful for detecting problems that are intermittent. The comparator output on the LT6108-2 is non-latching and can be used in applications where a latching output is not desired.

The comparator has one input available externally. The other comparator input is connected internally to the 400mV precision reference. The input threshold (the voltage which causes the output to transition from high to low) is designed to be equal to that of the reference. The reference voltage is established with respect to the device  $V^-$  connection.

### Comparator Input

The comparator input can swing from  $V^-$  to 60V regardless of the supply voltage used. The input current for inputs well above the threshold is just a few pAs. With decreasing input voltage, a small bias current begins to be drawn out of the input near the threshold, reaching 50nA max when at ground potential. Note that this change in input bias current can cause a small nonlinearity in the OUTA transfer function if the comparator input is coupled to the amplifier output with a voltage divider. For example, if the maximum comparator input current is 50nA, and the resistance seen looking out of the comparator input is 1k, then a change in output voltage of 50 $\mu$ V will be seen on the analog output when the comparator input voltage passes through its threshold.

## APPLICATIONS INFORMATION

### Setting Comparator Threshold

The comparator has an internal 400mV precision reference. In order to set the trip point of the LT6108 comparator as configured in Figure 11, the input sense voltage at which the comparator will trip,  $V_{SENSE(TRIP)}$  must be calculated:

$$V_{SENSE(TRIP)} = I_{SENSE(TRIP)} \cdot R_{SENSE}$$

The selection of  $R_{IN}$  is discussed in the Selection of External Input Gain Resistor  $R_{IN}$  section. Once  $R_{IN}$  is selected,  $R_{OUT}$  can be calculated:

$$R_{OUT} = R_{IN} \frac{400mV}{V_{SENSE(TRIP)}}$$

Since the amplifier output is connected directly to the comparator input, the gain from  $V_{SENSE}$  to  $V_{OUT}$  is:

$$A_V = \frac{400mV}{V_{SENSE(TRIP)}}$$

As shown in Figure 12,  $R_2$  can be used to increase the gain from  $V_{SENSE}$  to  $V_{OUT}$  without changing  $V_{SENSE(TRIP)}$ . As before,  $R_1$  can be easily calculated:

$$R_1 = R_{IN} \frac{400mV}{V_{SENSE(TRIP)}}$$

The gain is now:

$$A_V = \frac{R_1 + R_2}{R_{IN}}$$

This gain equation can be easily solved for  $R_2$ :

$$R_2 = A_V \cdot R_{IN} - R_1$$

If the configuration of Figure 11 gives too much gain,  $R_2$  can be used to reduce the gain without changing  $V_{SENSE(TRIP)}$  as shown in Figure 13.  $A_V$  can be easily calculated:

$$A_V = \frac{R_1}{R_{IN}}$$

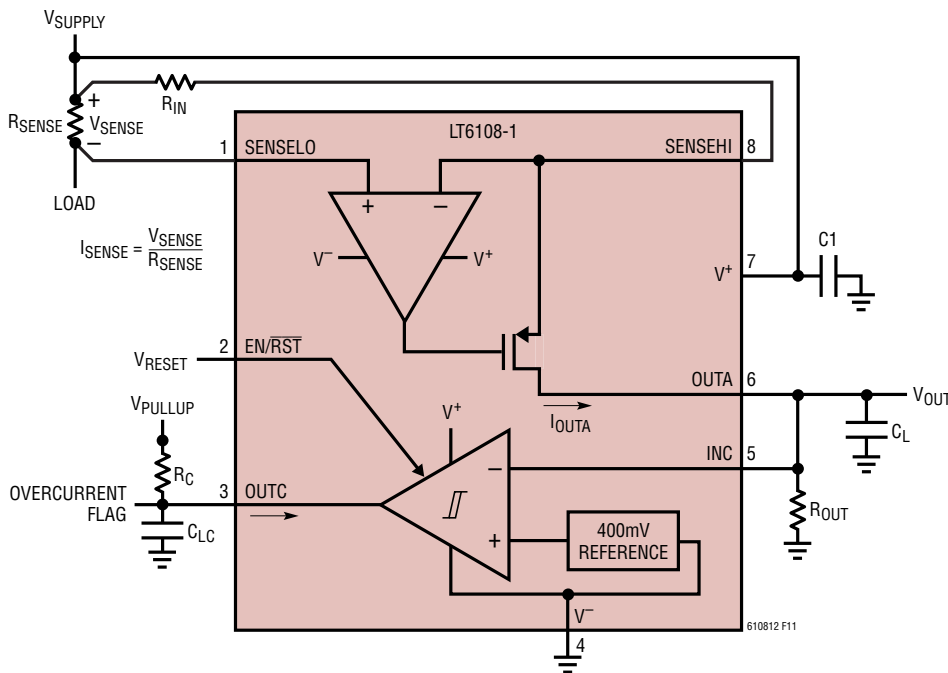

Figure 11. Basic Comparator Configuration

APPLICATIONS INFORMATION

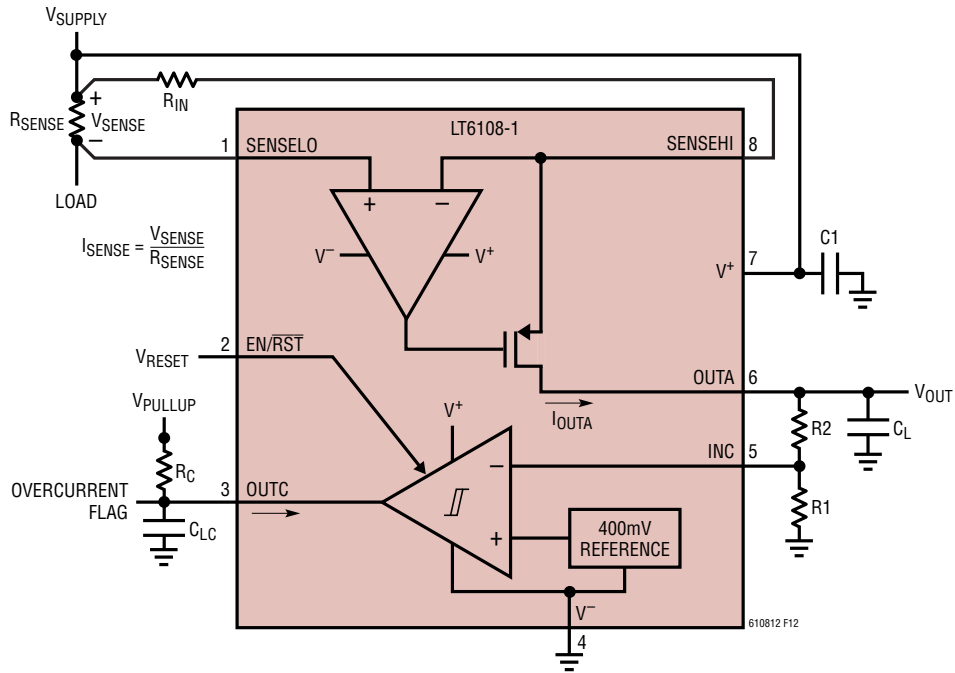

Figure 12: Comparator Configuration with Increased  $A_v$

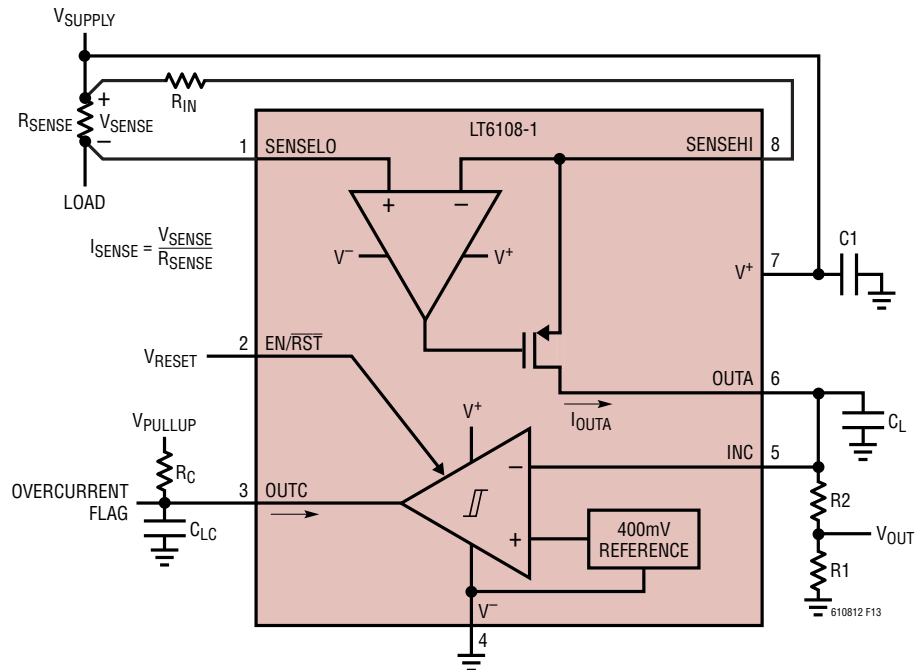

Figure 13: Comparator Configuration with Reduced  $A_v$

## APPLICATIONS INFORMATION

This gain equation can be easily solved for R1:

$$R1 = A_V \cdot R_{IN}$$

The value of R2 can be calculated:

$$R2 = \frac{400\text{mV} \cdot R_{IN} - V_{\text{SENSE(TRIP)}} \cdot R1}{V_{\text{SENSE(TRIP)}}$$

### Hysteresis

The comparator has a typical built-in hysteresis of 10mV to simplify design, ensure stable operation in the presence of noise at the input, and to reject supply noise that might be induced by state change load transients. The hysteresis is designed such that the threshold voltage is altered when the output is transitioning from low to high as is shown in Figure 14.

External positive feedback circuitry can be employed to increase the effective hysteresis if desired, but such

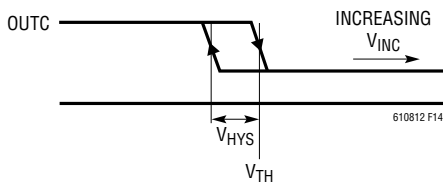

Figure 14. Comparator Output Transfer Characteristics

circuitry will have an effect on both the rising and falling input thresholds,  $V_{TH}$  (the actual internal threshold remains unaffected).

Figure 15 shows how to add additional hysteresis to the comparator.

R5 can be calculated from the amplifier output current which is required to cause the comparator output to trip,  $I_{OVER}$ .

$$R5 = \frac{400\text{mV}}{I_{OVER}}, \text{ Assuming } (R1+R2) \gg R5$$

To ensure  $(R1 + R2) \gg R5$ , R1 should be chosen such that  $R1 \gg R5$  so that  $V_{OUTA}$  does not change significantly when the comparator trips.

R3 should be chosen to allow sufficient  $V_{OL}$  and comparator output rise time due to capacitive loading.

R2 can be calculated:

$$R2 = R1 \cdot \left( \frac{V_{DD} - 390\text{mV}}{V_{\text{HYS(EXTRA)}}} \right)$$

Note that the hysteresis being added,  $V_{\text{HYS(EXTRA)}}$ , is in addition to the typical 10mV of built-in hysteresis. For very large values of R2 PCB related leakage may become an issue. A tee network can be implemented to reduce the required resistor values.

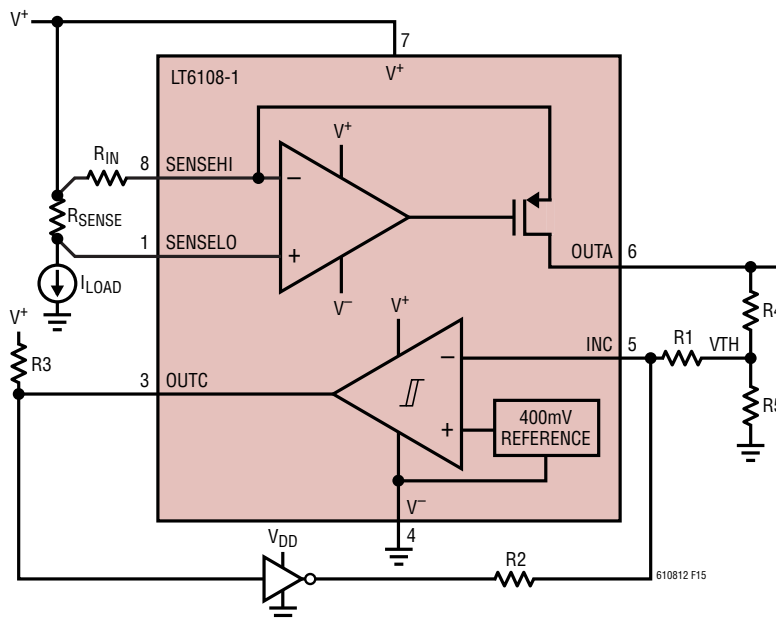

Figure 15. Inverting Comparator with Added Hysteresis

## APPLICATIONS INFORMATION

The approximate total hysteresis is:

$$V_{\text{HYS}} = 10\text{mV} + R1 \cdot \left( \frac{V_{\text{DD}} - 390\text{mV}}{R2} \right)$$

For example, to achieve  $I_{\text{OVER}} = 900\mu\text{A}$  with 50mV of total hysteresis,  $R5 = 442\Omega$ . Choosing  $R1 = 4.42\text{k}$ ,  $R3 = 10\text{k}$  and  $V_{\text{DD}} = 5\text{V}$  results in  $R2 = 513\text{k}$ .

The analog output voltage will also be affected when the comparator trips due to the current injected into  $R5$  by the positive feedback. Because of this, it is desirable to have  $(R1 + R2) \gg R5$ . The maximum  $V_{\text{OUTA}}$  error caused by this can be calculated as:

$$\Delta V_{\text{OUTA}} = V_{\text{DD}} \cdot \left( \frac{R5}{R1 + R2 + R5} \right)$$

In the previous example, this is an error of 4.3mV at the output of the amplifier or  $43\mu\text{V}$  at the input of the amplifier assuming a gain of 100.

When using the comparator with its input decoupled from the output of the amplifier it may be driven directly by a voltage source. It is useful to know the threshold voltage equations with additional hysteresis. The input rising edge threshold which causes the output to transition from high to low is:

$$V_{\text{TH(R)}} = 400\text{mV} \cdot \left( 1 + \frac{R1}{R2} \right)$$

The input falling edge threshold which causes the output to transition from low to high is:

$$V_{\text{TH(F)}} = 390\text{mV} \left( 1 + \frac{R1}{R2} \right) - V_{\text{DD}} \left( \frac{R1}{R2} \right)$$

### Comparator Output

The comparator output can maintain a logic-low level of 150mV while sinking  $500\mu\text{A}$ . The output can sink higher currents at elevated  $V_{\text{OL}}$  levels as shown in the Typical Performance Characteristics. Load currents are conducted to the  $V^-$  pin. The output off-state voltage may range between 0V and 60V with respect to  $V^-$ , regardless of the supply voltage used.

### EN/ $\overline{\text{RST}}$ Pin (LT6108-1 Only)

The EN/ $\overline{\text{RST}}$  pin performs the two functions of resetting the latch on the comparator as well as shutting down the LT6108-1. When this pin is pulled high the LT6108-1 is enabled. After powering on the LT6108-1, the comparator must be reset in order to guarantee a valid state at its output.

Applying a pulse to the EN/ $\overline{\text{RST}}$  pin will reset the comparator from its tripped low state as long as the input on the comparator is below the threshold and hysteresis. For example, if  $V_{\text{INC}}$  is pulled higher than 400mV and latches the comparator, a reset pulse will not reset that comparator unless its input is held below the threshold by a voltage greater than the 10mV typical hysteresis. The comparator output typically unlatches in  $0.5\mu\text{s}$  with 2pF of capacitive load. Increased capacitive loading on the comparator output will cause an increased unlatch time.

Figure 16 shows the reset functionality of the EN/ $\overline{\text{RST}}$  pin. The width of the pulse applied to reset the comparator must be greater than  $t_{\text{RPW(MIN)}}$  ( $2\mu\text{s}$ ) but less than  $t_{\text{RPW(MAX)}}$  ( $15\mu\text{s}$ ). Applying a pulse that is longer than  $40\mu\text{s}$  typically (or tying the pin low) will cause the part to enter shutdown. Once the part has entered shutdown, the supply current will be reduced to  $3\mu\text{A}$  typically and the amplifier, comparator and reference will cease to function until the EN/ $\overline{\text{RST}}$  pin is transitioned high. When the part is disabled, both the amplifier and comparator outputs are high impedance.

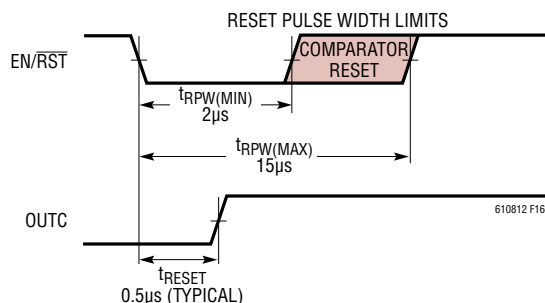

Figure 16. Comparator Reset Functionality

When the EN/ $\overline{\text{RST}}$  pin is transitioned from low to high to enable the part, the amplifier output PMOS can turn on momentarily causing typically 1mA of current to flow into the SENSEHI pin and out of the OUTA pin. Once the amplifier is fully on, the output will go to the correct

610812fa

## APPLICATIONS INFORMATION

current. Figure 17 shows this behavior and the impact it has on  $V_{OUTA}$ . Circuitry connected to  $OUTA$  can be protected from these transients by using an external diode to clamp  $V_{OUTA}$ , or a capacitor to filter  $V_{OUTA}$ .

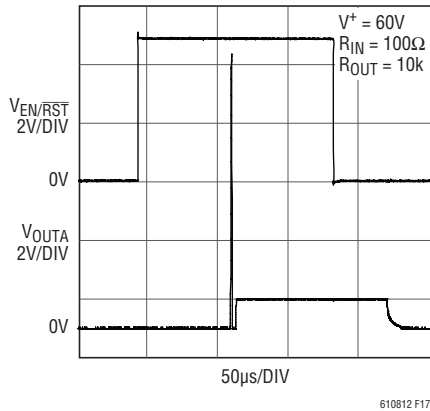

Figure 17. Amplifier Enable Response

### EN Pin (LT6108-2)

When this pin is pulled high, the LT6108-2 is enabled. When the enable pin is pulled low for longer than 40µs typically, the LT6108-2 will enter the shutdown mode.

### Power Up

After powering on the LT6108-1, the comparator must be reset in order to guarantee a valid state at its output. Fast supply ramps may cause a supply current transient during start-up as shown in the Typical Performance Characteristics. This current can be lowered by reducing the edge speed of the supply.

### Reverse-Supply Protection

The LT6108 is not protected internally from external reversal of supply polarity. To prevent damage that may occur during this condition, a Schottky diode should be added in series with  $V^-$  (Figure 18). This will limit the reverse current through the LT6108. Note that this diode will limit the low voltage operation of the LT6108 by effectively reducing the supply voltage to the part by  $V_D$ .

Also note that the comparator reference, comparator output and  $EN/RST$  input are referenced to the  $V^-$  pin. In order to preserve the precision of the reference and to avoid driving the comparator inputs below  $V^-$ ,  $R2$  must connect to the  $V^-$  pin. This will shift the amplifier output voltage up by  $V_D$ .  $V_{OUTA}$  can be accurately measured

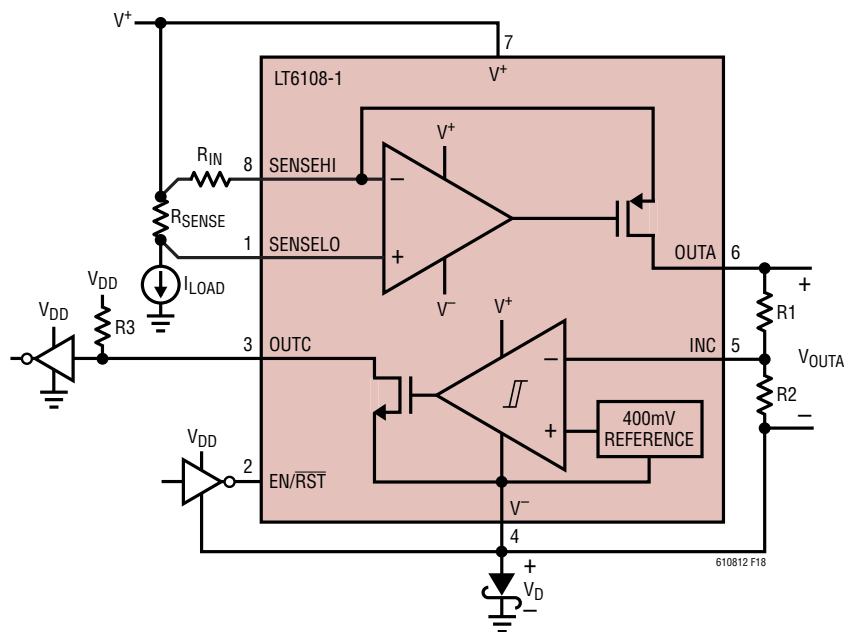

Figure 18. Schottky Prevents Damage During Supply Reversal

## APPLICATIONS INFORMATION

differentially across R1 and R2. The comparator output low voltage will also be shifted up by  $V_D$ . The  $\overline{EN/RST}$  pin threshold is referenced to the  $V^-$  pin. In order to provide

valid input levels to the LT6108 and avoid driving  $\overline{EN/RST}$  below  $V^-$  the negative supply of the driving circuit should be tied to  $V^-$  of the LT6108.

## TYPICAL APPLICATIONS

### Overcurrent Battery Fault Protection

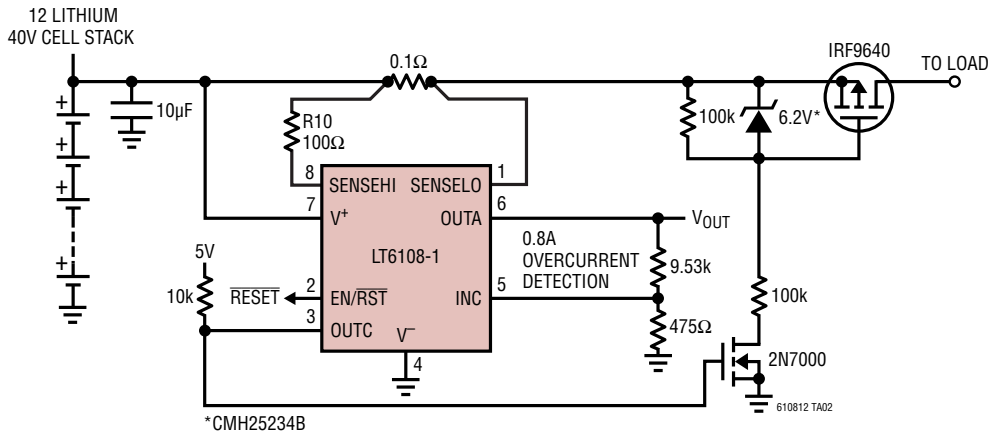

### MCU Interfacing with Hardware Interrupts

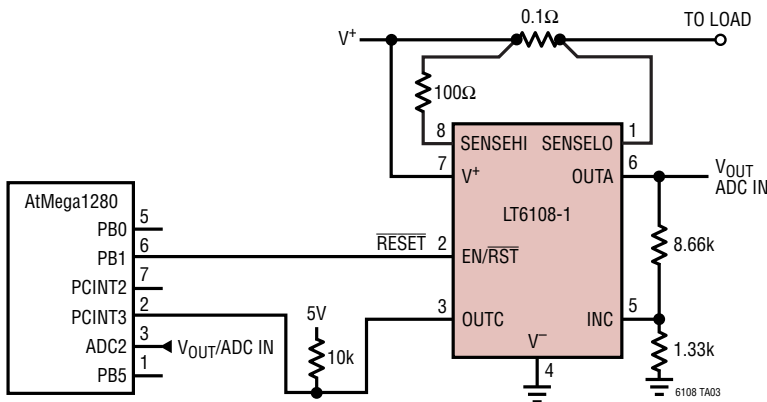

#### Example:

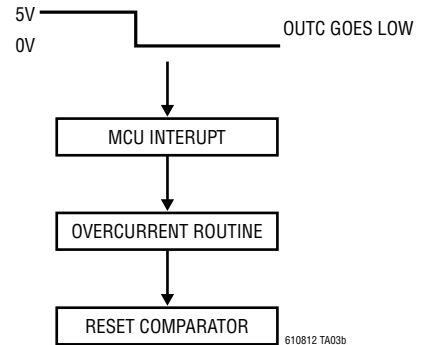

The comparator is set to have a 300mA overcurrent threshold. The MCU will receive the comparator output as

a hardware interrupt and immediately run an appropriate fault routine.

## TYPICAL APPLICATIONS

### Simplified DC Motor Torque Control

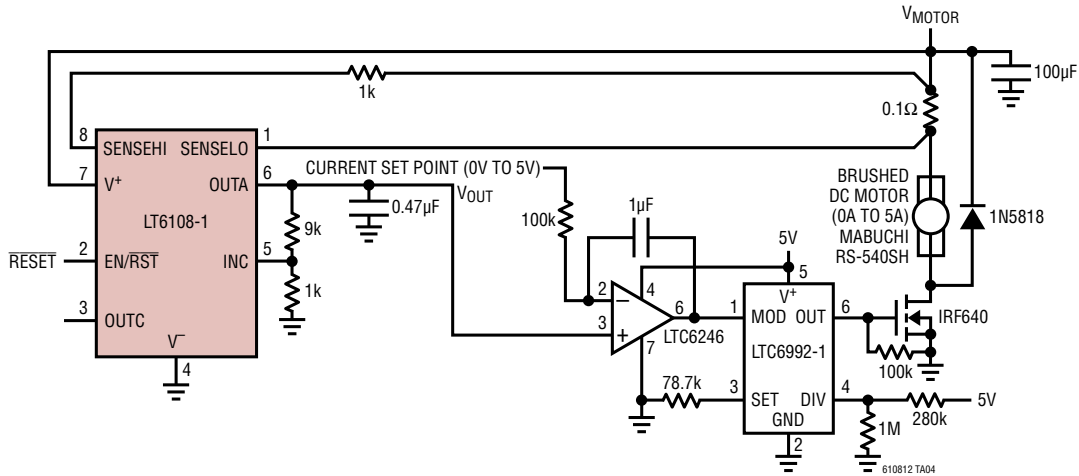

The figure above shows a simplified DC motor control circuit. The circuit controls motor current, which is proportional to motor torque; the LT6108 is used to provide current feedback to an integrator that servos the motor

current to the current set point. The LTC<sup>®</sup>6992 is used to convert the output of the difference amp to the motors PWM control signal.

### Power-On Reset or Disconnect Using TimerBlox<sup>®</sup> Circuit

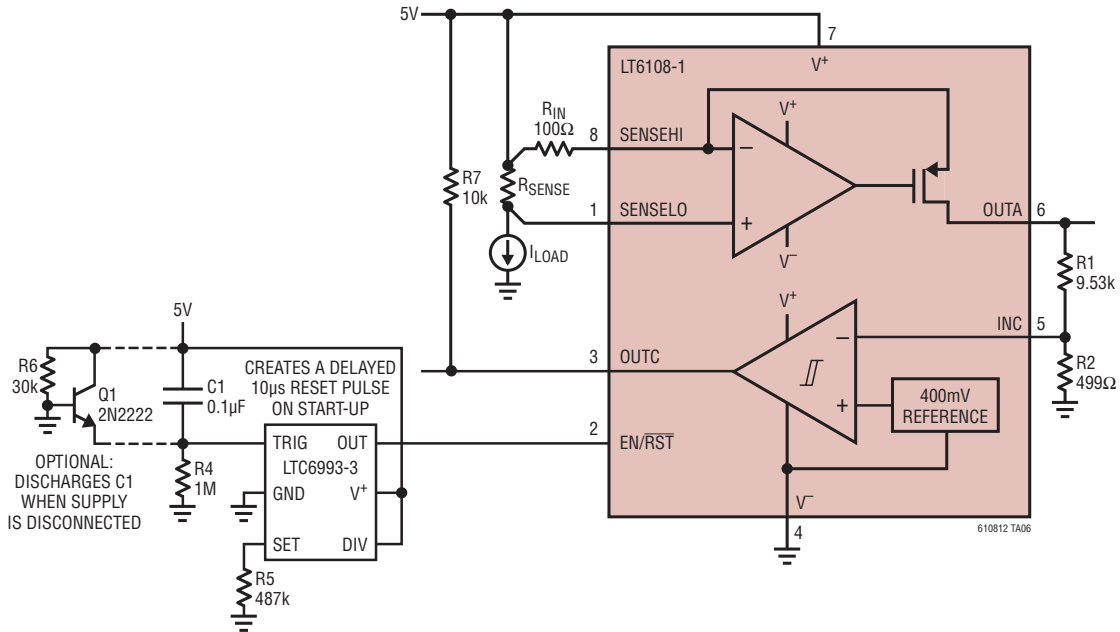

The LTC6993-3 provides a 10μs reset pulse to the LT6108-1. The reset pulse is delayed by R4 and C1 whose time constant must be greater than 10ms and longer than the supply turn-on time. Optional components R6 and Q1 discharge capacitor C1 when the supply and/or ground are disconnected. This ensures that when the power supply and/or

ground are restored, capacitor C1 can fully recharge and trigger the LTC6993-3 to produce another comparator reset pulse. These optional components are particularly useful if the power and/or ground connections are intermittent, as can occur when PCB are plugged into a connector.



## TYPICAL APPLICATIONS

LT6108-2 with External Latch and Power-On Reset or Disconnect

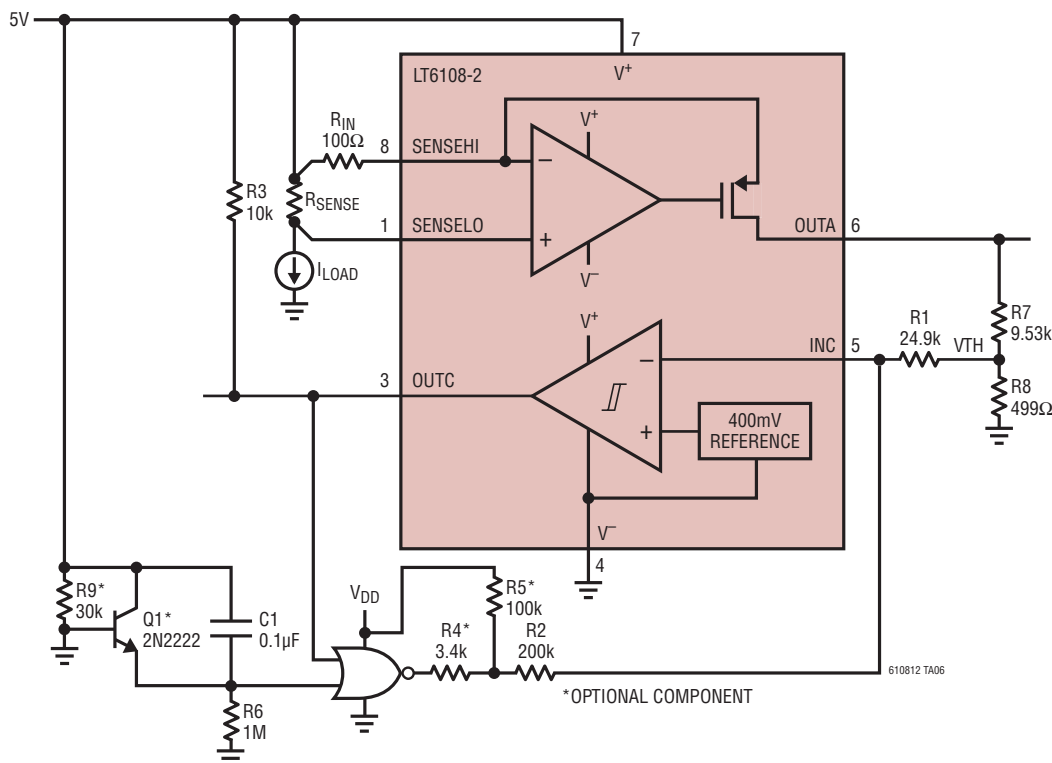

An external latch is implemented with positive feedback. R6 and C1 provide a reset pulse on power-up. The time constant formed by R6 and C1 should be set slower than that of the supply. Optional components R9 and Q1 discharge capacitor C1 when the supply and/or ground are disconnected. This ensures that when the power supply and/or ground are restored, capacitor C1 can fully recharge. While C1 is charging, the NOR gate output is low, ensuring that the comparator powers up in the correct state. These optional components are particularly useful if the power and/or ground connections are intermittent, as can occur when PCB are plugged into a connector. R4 and R5 are optional and minimize the movement of the rising input threshold voltage.

The input rising edge threshold which causes the output to transition from high to low is:

$$V_{TH(R)} = 400\text{mV} \text{ if } R4 = R5 \cdot \left( \frac{400\text{mV}}{V_{DD} - 400\text{mV}} \right)$$

The input falling edge which causes the output to transition from low to high is:

$$V_{TH(F)} = 390\text{mV} \cdot R1 \cdot \left( \frac{1}{R1} + \frac{1}{R2 + R4 || R5} \right) - \left( \frac{V_{DD} \cdot R1}{R2 + R4 || R5} \right)$$



# PACKAGE DESCRIPTION

Please refer to <http://www.linear.com/designtools/packaging/> for the most recent package drawings.

## MS8 Package 8-Lead Plastic MSOP (Reference LTC DWG # 05-08-1660 Rev F)

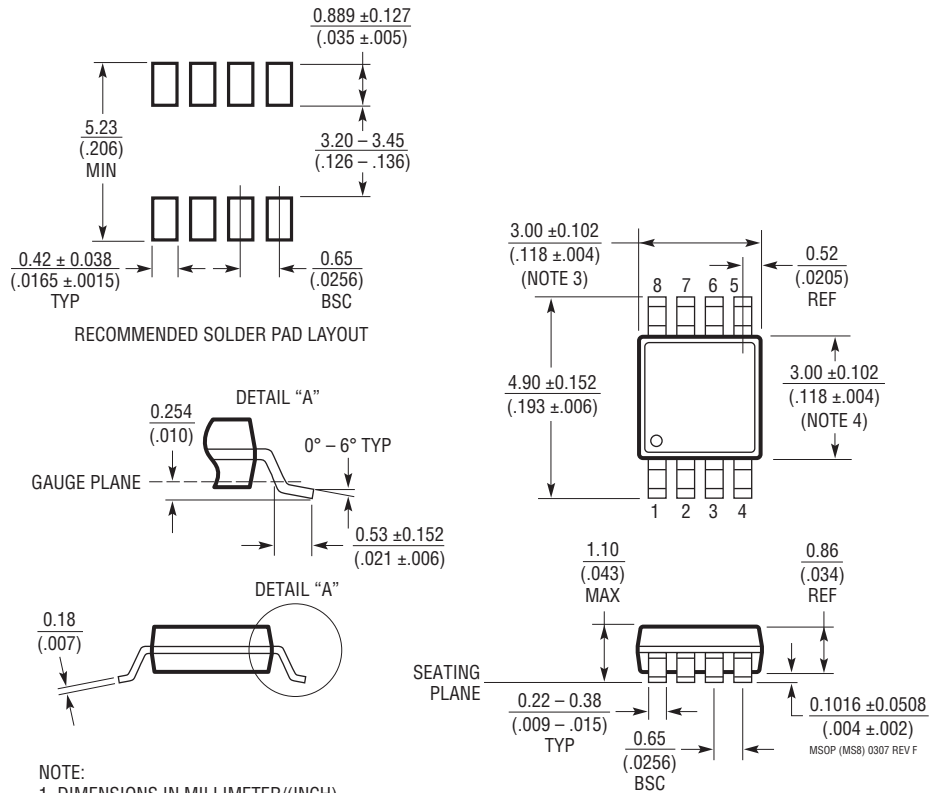

- NOTE:
1. DIMENSIONS IN MILLIMETER/(INCH)
  2. DRAWING NOT TO SCALE
  3. DIMENSION DOES NOT INCLUDE MOLD FLASH, PROTRUSIONS OR GATE BURRS. MOLD FLASH, PROTRUSIONS OR GATE BURRS SHALL NOT EXCEED 0.152mm (.006") PER SIDE
  4. DIMENSION DOES NOT INCLUDE INTERLEAD FLASH OR PROTRUSIONS. INTERLEAD FLASH OR PROTRUSIONS SHALL NOT EXCEED 0.152mm (.006") PER SIDE
  5. LEAD COPLANARITY (BOTTOM OF LEADS AFTER FORMING) SHALL BE 0.102mm (.004") MAX

## PACKAGE DESCRIPTION

Please refer to <http://www.linear.com/designtools/packaging/> for the most recent package drawings.

### DCB Package 8-Lead Plastic DFN (2mm × 3mm) (Reference LTC DWG # 05-08-1718 Rev A)

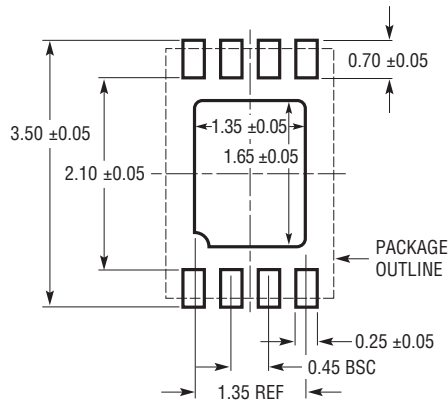

RECOMMENDED SOLDER PAD PITCH AND DIMENSIONS  
APPLY SOLDER MASK TO AREAS THAT ARE NOT SOLDERED

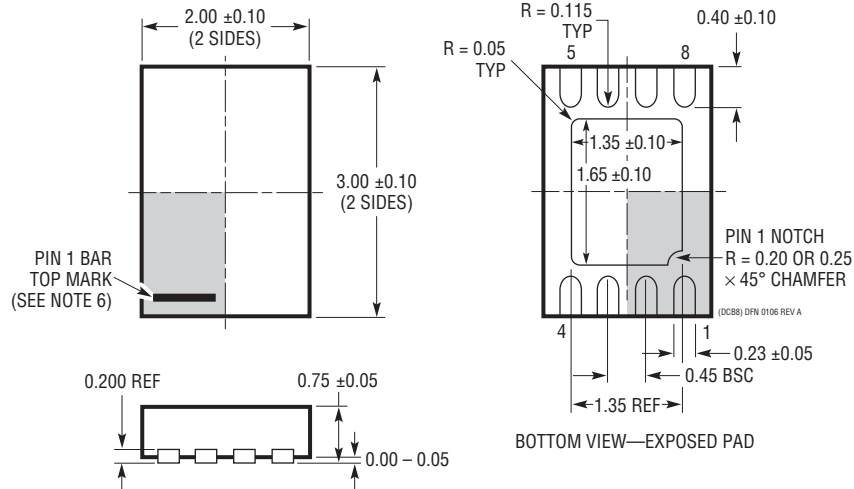

- NOTE:
1. DRAWING IS NOT A JEDEC PACKAGE OUTLINE
  2. DRAWING NOT TO SCALE
  3. ALL DIMENSIONS ARE IN MILLIMETERS
  4. DIMENSIONS OF EXPOSED PAD ON BOTTOM OF PACKAGE DO NOT INCLUDE MOLD FLASH. MOLD FLASH, IF PRESENT, SHALL NOT EXCEED 0.15mm ON ANY SIDE
  5. EXPOSED PAD SHALL BE SOLDER PLATED
  6. SHADED AREA IS ONLY A REFERENCE FOR PIN 1 LOCATION ON THE TOP AND BOTTOM OF PACKAGE

## REVISION HISTORY

REV	DATE	DESCRIPTION	PAGE NUMBER
A	12/12	Addition of A-grade Performance and Electrical Characteristics	1, 3, 4, 5, 12, 13, 16 (Fig10), 28
		Addition of A-grade Order Information	2
		Clarification to Absolute Maximum Short Circuit Duration	2
		Clarification to nomenclature used in Typical Performance Characteristics	6, 7, 9
		Clarification to Description of EN/RST Pin Function	10
		Internal Reference Block redrawn for consistency	11, 13, 18, 19
		Additional information provided to Reverse Supply Protection	22
		Correction to Overcurrent Battery Fault Protection diagram	23

## TYPICAL APPLICATION

ADC Driving Application

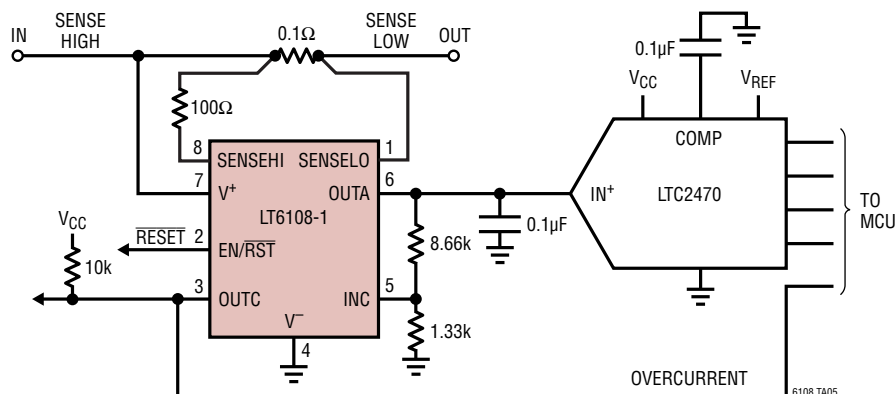

The low sampling current of the LTC2470 16-bit delta sigma ADC is ideal for the LT6108.

## RELATED PARTS

PART NUMBER	DESCRIPTION	COMMENTS
LT1787	Bidirectional High Side Current Sense Amplifier	2.7V to 60V, 75μV Offset, 60μA Quiescent, 8V/V Gain
LTC4150	Coulomb Counter/Battery Gas Gauge	Indicates Charge Quantity and Polarity
LT6100	Gain-Selectable High Side Current Sense Amplifier	4.1V to 48V, Gain Settings: 10, 12.5, 20, 25, 40, 50V/V
LTC6101	High Voltage High Side Current Sense Amplifier	Up to 100V, Resistor Set Gain, 300μV Offset, SOT-23
LTC6102	Zero Drift High Side Current Sense Amplifier	Up to 100V, Resistor Set Gain, 10μV Offset, MSOP8/DFN
LTC6103	Dual High Side Current Sense Amplifier	4V to 60V, Resistor Set Gain, 2 Independent Amps, MSOP8
LTC6104	Bidirectional High Side Current Sense Amplifier	4V to 60V, Separate Gain Control for Each Direction, MSOP8
LT6105	Precision Rail-to-Rail Input Current Sense Amplifier	-0.3V to 44V Input Range, 300μV Offset, 1% Gain Error
LT6106	Low Cost High Side Current Sense Amplifier	2.7V to 36V, 250μV Offset, Resistor Set Gain, SOT-23
LT6107	High Temperature High Side Current Sense Amplifier	2.7V to 36V, -55°C to 150°C, Fully Tested: -55°C, 25°C, 150°C
LT6109	High Side Current Sense Amplifier with Reference and Comparators	2.7V to 60V, 125μV, Resistor Set Gain, ±1.25% Threshold Error
LT6700	Dual Comparator with 400mV Reference	1.4V to 18V, 6.5μA Supply Current

## Данный компонент на территории Российской Федерации

### Вы можете приобрести в компании MosChip.

Для оперативного оформления запроса Вам необходимо перейти по данной ссылке:

<http://moschip.ru/get-element>

Вы можете разместить у нас заказ для любого Вашего проекта, будь то серийное производство или разработка единичного прибора.

В нашем ассортименте представлены ведущие мировые производители активных и пассивных электронных компонентов.

Нашей специализацией является поставка электронной компонентной базы двойного назначения, продукции таких производителей как XILINX, Intel (ex.ALTERA), Vicor, Microchip, Texas Instruments, Analog Devices, Mini-Circuits, Amphenol, Glenair.

Сотрудничество с глобальными дистрибьюторами электронных компонентов, предоставляет возможность заказывать и получать с международных складов практически любой перечень компонентов в оптимальные для Вас сроки.

На всех этапах разработки и производства наши партнеры могут получить квалифицированную поддержку опытных инженеров.

Система менеджмента качества компании отвечает требованиям в соответствии с ГОСТ Р ИСО 9001, ГОСТ РВ 0015-002 и ЭС РД 009

### Офис по работе с юридическими лицами:

105318, г.Москва, ул.Щербаковская д.3, офис 1107, 1118, ДЦ «Щербаковский»

Телефон: +7 495 668-12-70 (многоканальный)

Факс: +7 495 668-12-70 (доб.304)

E-mail: [info@moschip.ru](mailto:info@moschip.ru)

Skype отдела продаж:

moschip.ru

moschip.ru\_4

moschip.ru\_6

moschip.ru\_9