



# KS8721BL/SL

## 3.3V Single Power Supply 10/100BASE-TX/FX MII Physical Layer Transceiver

Rev. 1.3

### General Description

Operating with a 2.5V core to meet low-voltage and low-power requirements, the KS8721BL and KS8721SL are 10BASE-T/100BASE-TX/FX Physical Layer Transceivers that use MII and RMII interfaces to transmit and receive data. They contain 10BASE-T Physical Medium Attachment (PMA), Physical Medium Dependent (PMD), and Physical Coding Sub-layer (PCS) functions. The KS8721BL/SL also have on-chip 10BASE-T output filtering. This eliminates the need for external filters and allows a single set of line magnetics to be used to meet requirements for both 100BASE-TX and 10BASE-T.

The KS8721BL/SL automatically configure themselves for 100 or 10Mbps and full- or half-duplex operation, using an on-chip auto-negotiation algorithm. They are the ideal physical layer transceiver for 100BASE-TX/10BASE-T applications.

### Features

- Single chip 100BASE-TX/100BASE-FX/10BASE-T physical layer solution
- 2.5V CMOS design; 2.5/3.3V tolerance on I/O
- 3.3V single power supply with built-in voltage regulator; Power consumption <340mW (including output driver current)
- Fully compliant to IEEE 802.3u standard
- Supports MII and Reduced MII (RMII)
- Supports 10BASE-T, 100BASE-TX, and 100BASE-FX with Far\_End\_Fault Detection
- Supports power-down and power-saving modes
- Configurable through MII serial management ports or via external control pins

### Functional Diagram

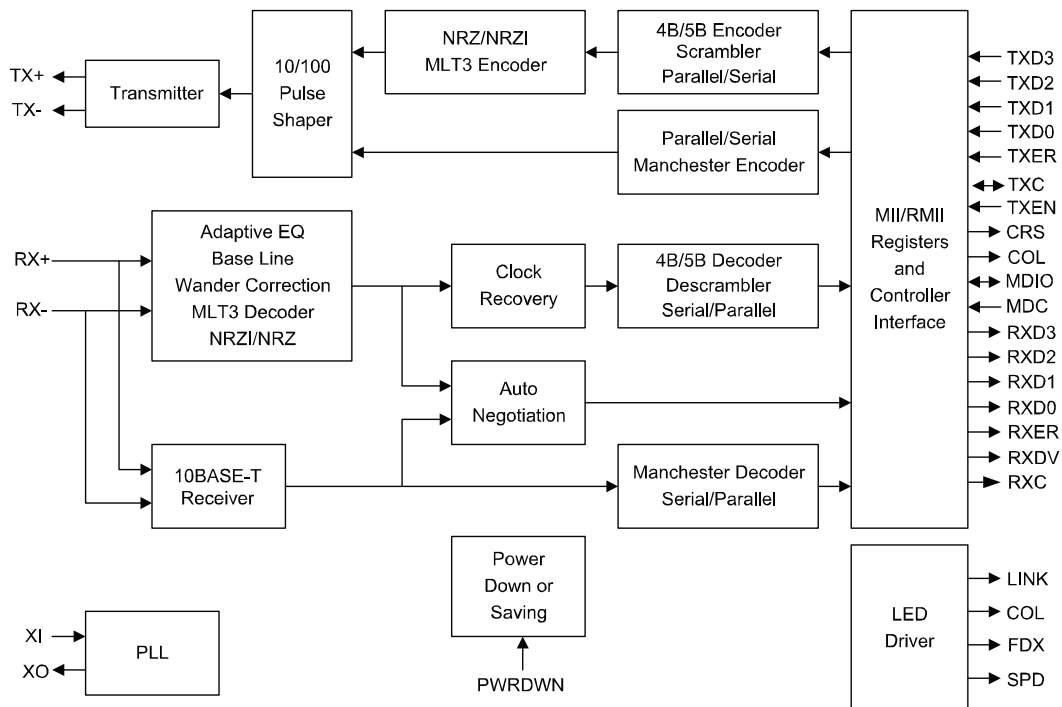

## Features (continued)

- Supports auto-negotiation and manual selection for 10/100Mbps speed and full-/half-duplex modes
- On-chip, built-in, analog front-end filtering for both 10BASE-TX and 10BASE-T
- LED outputs for link, activity, full-/half-duplex, collision, and speed
- Supports back-to-back, FX to TX for media converter applications
- Supports MDI/MDI-X auto-crossover
- KS8721BL is a drop-in replacement for the KS8721BT in the same footprint
- KS8721SL is a drop-in replacement for the KS8721B in the same footprint
- Commercial Temperature Range: 0°C to +70°C
- Industrial Temperature Range: -40°C to +85°C
- Available in 48-pin SSOP and LQFP

## Ordering Information

Part Number	Temp. Range	Package	Lead Finish
KS8721BL	0°C to 70°C	48-Pin LQFP	Standard
KS8721SL	0°C to 70°C	48-Pin SSOP	Standard
KS8721BLI	-40°C to +85°C	48-Pin LQFP	Standard
KSZ8721BL	0°C to 70°C	48-Pin LQFP	Lead-Free
KSZ8721SL	0°C to 70°C	48-Pin SSOP	Lead-Free
KSZ8721BLI	-40°C to +85°C	48-Pin LQFP	Lead-Free
KSZ8721SLI	-40°C to +85°C	48-Pin SSOP	Lead-Free

## Revision History

Revision	Date	Summary of Changes
0.9	01/12/04	Data sheet created.
1.0	03/06/04	Initial release. Change to new format. Added part-ordering information. Editorial changes on pin description, RMII, and media converter operation. Update circuit design, reset timing, thermal resistance, electrical characteristics, and strapping option circuit.
1.1	05/17/04	Added BLI product information.
1.2	01/21/05	MDIO Pull-up resistor value changed to 4.7k $\Omega$ . Added note on strapping option pins. Updated bits 1b.0 - 1b.7 to self clearing. Updated electrical characteristics. Updated reference schematic for strapping option configuration to 3.3V. Crystal spec updated to 40 $\Omega$ series resistance. Added additional magnetics to qualified transformer table. Added 2 lead-free part options. Added recommended reset circuit.
1.3	06/25/09	Update ordering information.

## Contents

<b>Pin Configuration</b> .....	<b>6</b>
<b>Pin Description</b> .....	<b>7</b>
<b>Strapping Options<sup>(1)</sup></b> .....	<b>10</b>
<b>Functional Description</b> .....	<b>11</b>
100BASE-TX Transmit.....	11
100BASE-TX Receive.....	11
PLL Clock Synthesizer.....	11
Scrambler/De-scrambler (100BASE-TX only) .....	11
10BASE-T Transmit.....	11
10BASE-T Receive.....	11
SQE and Jabber Function (10BASE-T only) .....	12
Auto-Negotiation .....	12
MII Management Interface .....	12
MII Data Interface .....	12
<i>Transmit Clock (TXC)</i> .....	12
<i>Receive Clock (RXC)</i> .....	12
<i>Transmit Enable</i> .....	13
<i>Receive Data Valid</i> .....	13
<i>Error Signals</i> .....	13
<i>Carrier Sense (CRS)</i> .....	13
<i>Collision</i> .....	13
RMII (Reduced MII) Data Interface.....	13
RMII Signal Definition .....	13
Reference Clock (REF_CLK).....	14
Carrier Sense/Receive Data Valid (CRS_DV).....	14
Receive Data [1:0] (RXD[1:0]) .....	14
Transmit Enable (TX_EN).....	14
Transmit Data [1:0] (TXD[1:0]).....	14
Collision Detection .....	14
RX_ER.....	14
RMII AC Characteristics.....	15
Unused RMII Pins .....	15
Auto-Crossover (Auto-MDI/MDI-X) .....	15
Power Management.....	16
100BT FX Mode.....	16
Media Converter Operation.....	17
Circuit Design Reference for Power Supply .....	18
<b>Register Map</b> .....	<b>19</b>
Register 0h - Basic Control .....	19
Register 1h - Basic Status .....	19
Register 2h - PHY Identifier 1 .....	20
Register 3h - PHY Identifier 2 .....	20
Register 4h - Auto-Negotiation Advertisement .....	20
Register 5h - Auto-Negotiation Link Partner Ability .....	21
Register 6h - Auto-Negotiation Expansion.....	21
Register 7h - Auto-Negotiation Next Page.....	21
Register 8h - Link Partner Next Page Ability .....	22
Register 15h - RXER Counter.....	22
Register 1bh - Interrupt Control/Status Register .....	22
Register 1fh - 100BASE-TX PHY Controller.....	23
<b>Absolute Maximum Ratings<sup>(1)</sup></b> .....	<b>24</b>
<b>Operating Ratings<sup>(2)</sup></b> .....	<b>24</b>
<b>Electrical Characteristics<sup>(4)</sup></b> .....	<b>24</b>

---

<b>Timing Diagrams .....</b>	<b>26</b>
<b>Selection of Isolation Transformers<sup>(1)</sup> .....</b>	<b>33</b>
<b>Selection of Reference Crystal .....</b>	<b>33</b>
<b>Package Information .....</b>	<b>34</b>

## Pin Configuration

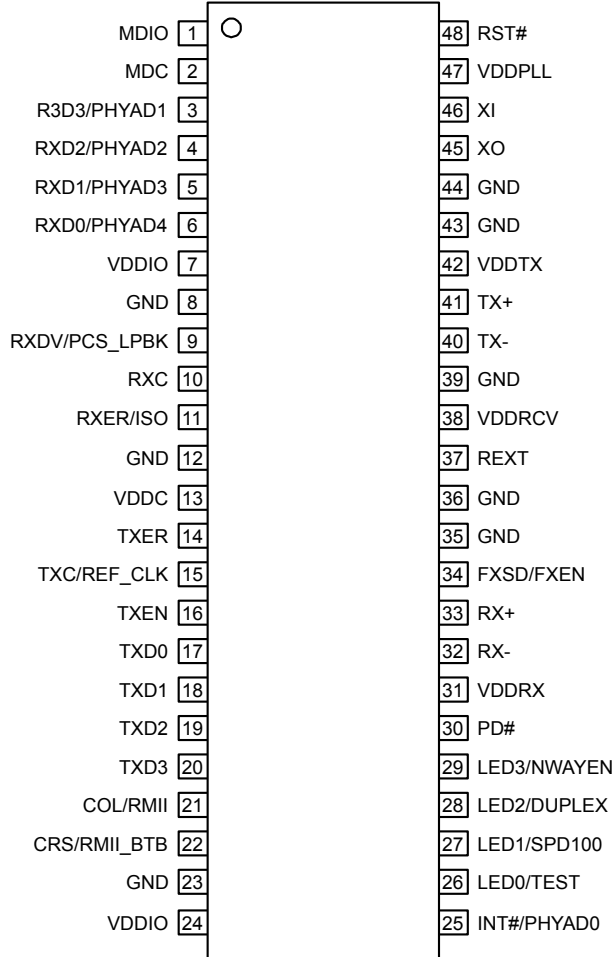

48-Pin SSOP (SM)



48-Pin LQFP (LQ)

## Pin Description

Pin Number	Pin Name	Type <sup>(1)</sup>	Pin Function
1	MDIO	I/O	Management Independent Interface (MII) Data I/O. This pin requires an external 4.7K pull-up resistor.
2	MDC	I	MII Clock Input. This pin is synchronous to the MDIO.
3	RXD3/ PHYAD	lpd/O	MII Receive Data Output. RXD [3..0], these bits are synchronous with RXCLK. When RXDV is asserted, RXD [3..0] presents valid data to MAC through the MII. RXD [3..0] is invalid when RXDV is de-asserted. During reset, the pull-up/pull-down value is latched as PHYADDR [1]. See "Strapping Options" section for details.
4	RXD2/ PHYAD2	lpd/O	MII Receive Data Output. During reset, the pull-up/pull-down value is latched as PHYADDR[2]. See "Strapping Options" section for details.
5	RXD1/ PHYAD3	lpd/O	MII Receive Data Output. During reset, the pull-up/pull-down value is latched as PHYADDR[3]. See "Strapping Options" section for details.
6	RXD0/ PHYAD4	lpd/O	MII Receive Data Output. During reset, the pull-up/pull-down value is latched as PHYADDR[4]. See "Strapping Options" section for details.
7	VDDIO	P	Digital IO 2.5 /3.3V tolerant power supply. 3.3V power Input of voltage regulator. See "Circuit Design Ref. for Power Supply" section for details.
8	GND	Gnd	Ground.
9	RXDV/ CRSDV/ PCS_LPBK	lpd/O	MII Receive Data Valid Output. During reset, the pull-up/pull-down value is latched as PCS_LPBK. See "Strapping Options" section for details.
10	RXC	O	MII Receive Clock Output. Operating at 25MHz = 100Mbps, 2.5MHz = 10Mbps.
11	RXER/ISO	lpd/O	MII Receive Error Output. During reset, the pull-up/pull-down value is latched as ISOLATE during reset. See "Strapping Options" section for details.
12	GND	Gnd	Ground.
13	VDDC	P	Digital core 2.5V only power supply. See "Circuit Design Ref. for Power Supply" section for details.
14	TXER	lpd	MII Transmit Error Input.
15	TXC/ REFCLK	I/O	MII Transmit Clock Output. Input for crystal or an external 50MHz clock. When REFCLK pin is used for REF clock interface, pull up XI to VDDPLL 2.5V via 10kΩ resistor and leave XO pin unconnected.
16	TXEN	lpd	MII Transmit Enable Input.
17	TXD0	lpd	MII Transmit Data Input.
18	TXD1	lpd	MII Transmit Data Input.
19	TXD2	lpd	MII Transmit Data Input.
20	TXD3	lpd	MII Transmit Data Input.
21	COL/ RMII	lpd/O	MII Collision Detect Output. During reset, the pull-up/pull-down value is latched as RMII select. See "Strapping Options" section for details.
22	CRS/ RMII_BT	lpd/O	MII Carrier Sense Output. During reset, the pull-up/pull-down value is latched as RMII back-to-back mode when RMII mode is selected. See "Strapping Options" section for details.
23	GND	Gnd	Ground.

Pin Number	Pin Name	Type <sup>(1)</sup>	Pin Function		
24	VDDIO	P	Digital IO 2.5/3.3V tolerant power supply. 3.3V power input of voltage regulator. See "Circuit Design Ref. for Power Supply" section for details.		
25	INT#/ PHYAD0	lpu/O	Management Interface (MII) Interrupt Out. Interrupt level set by Register 1f, bit 9. During reset, latched as PHYAD[0]. See "Strapping Options" section for details.		
26	LED0/ TEST	lpu/O	Link/Activity LED Output. The external pull-down enable test mode and only used for the factory test. Active low.		
			Link/Act	Pin State	LED Definition PHYAD0
			No Link	H	"Off"
			Link	L	"On"
Act	–	"Toggle"			
27	LED1/ SPD100/ nFEF	lpu/O	Speed LED Output. Latched as SPEED (Register 0, bit 13) during power-up/ reset. See "Strapping Options" section for details. Active low.		
			Speed	Pin State	LED Definition
			10BT	H	"Off"
100BT	L	"On"			
28	LED2	lpu/O	Full-duplex LED Output. Latched as DUPLEX (register 0h, bit 8) during power-up/ reset. See "Strapping DUPLEX Options" section for details. Active low.		
			Duplex	Pin State	LED Definition
			Half	H	"Off"
Full	L	"On"			
29	LED3/ NWAYEN	lpu/O	Collision LED Output. Latched as ANEG_EN (register 0h, bit 12) during power-up/ reset. See "Strapping Options" section for details.		
			Collision	Pin State	LED Definition
			No Collision	H	"Off"
Collision	L	"On"			
30	PD#	lpu	Power Down. 1 = Normal operation, 0 = Power-down. Active low.		
31	VDDRX	P	Analog 2.5V power supply. See "Circuit Design Ref. for Power Supply" section for details.		
32	RX-	I	Receive Input. Differential receive input pins for 100FX, 100BASE-TX, or 10BASE-T.		
33	RX+	I	Receive Input: Differential receive input pin for 100FX, 100BASE-TX, or 10BASE-T.		
34	FXSD/ FXEN	lpu/O	Fiber Mode Enable / Signal Detect in Fiber Mode. If FXEN = 0, FX mode is disable. The default is "0". See "100BT FX Mode" section for more details.		
35	GND	Gnd	Ground.		
36	GND	Gnd	Ground.		
37	REXT	I	External resistor (6.49kW ) connects to REXT and GND.		
38	VDDRCV	P	Analog 2.5V power supply. 2.5V power output of voltage regulator. See "Circuit Design Ref. for Power Supply" section for details.		
39	GND	Gnd	Ground.		
40	TX-	O	Transmit Outputs: Differential transmit output for 100FX, 100BASE-TX, or 10BASE-T.		
41	TX+	O	Transmit Outputs: Differential transmit output for 100FX, 100BASE-TX, or 10BASE-T.		
42	VDDTX	P	Transmitter 2.5V power supply. See "Circuit Design Ref. for Power Supply" section for details.		
43	GND	Gnd	Ground.		



Pin Number	Pin Name	Type <sup>(1)</sup>	Pin Function
44	GND	Gnd	Ground.
45	XO	O	XTAL feedback: Used with XI for Xtal application.
46	XI	I	Crystal Oscillator Input: Input for a crystal or an external 25MHz clock. If an oscillator is used, XI connects to a 3.3V tolerant oscillator, and X2 is a no-connect.
47	VDDPLL	P	Analog PLL 2.5V power supply. See "Circuit Design Ref. for Power Supply" section for details.
48	RST#	Ipu	Chip Reset. Active low, minimum of 50µs pulse is required.

**Note:**

- P = Power supply.  
 Gnd = Ground.  
 I = Input.  
 O = Output.  
 I/O = Bi-directional.  
 Ipd = Input with internal pull-down.  
 Ipu = Input with internal pull-up.  
 Ipd/O = Input with internal pull-down during reset; output pin otherwise.  
 Ipu/O = Input with internal pull-up during reset; output pin otherwise.

## Strapping Options<sup>(1)</sup>

Pin Number	Pin Name	Type <sup>(2)</sup>	Pin Function
6, 5, 4, 3	PHYAD[4:1]/ RXD[0:3]	lpd/O	PHY Address latched at power-up/reset. The default PHY address is 00001.
25	PHYAD0/ INT#	lpu/O	
9 <sup>(3)</sup>	PCS_LPBK/ RXDV	lpd/O	Enables PCS_LPBK mode at power-up/reset. PD (default) = Disable, PU = Enable.
11 <sup>(3)</sup>	ISO/RXER	lpd/O	Enables ISOLATE mode at power-up/reset. PD (default) = Disable, PU = Enable.
21 <sup>(3)</sup>	RMII/COL	lpd/O	Enables RMII mode at power-up/reset. PD (default) = Disable, PU = Enable.
22 <sup>(3)</sup>	RMII_BT CRS	lpd/O	Enable RMII back-to-back mode at power-up/reset. PD (default) = Disable, PU = Enable.
27	SPD100/ No FEF/	lpu/O	Latched into Register 0h bit 13 during power-up/reset. PD = 10Mbps, PU (default) = 100Mbps. If SPD100 is asserted during power-up/reset, this pin is also latched as LED1 the Speed Support in register 4h. (If FXEN is pulled up, the latched value 0 means no Far_End_Fault.)
28	DUPLEX/ LED2	lpu/O	Latched into Register 0h bit 8 during power-up/reset. PD = Half-duplex, PU (default) = Full-duplex. If Duplex is pulled up during reset, this pin is also latched as the Duplex support in register 4h.
29	NWAYEN/ LED3	lpu/O	Nway (auto-negotiation) Enable. Latched into Register 0h bit 12 during power-up/reset. PD = Disable Auto-Negotiation, PU (default) = Enable Auto-Negotiation.
30	PD#	lpu	Power-Down Enable. PU (default) = Normal operation, PD = Power-Down mode.

### Notes:

- Strap-in is latched during power-up or reset.
- lpu = Input with internal pull-up.  
lpd/O = Input with internal pull-down during reset; output pin otherwise.  
lpu/O = Input with internal pull-up during reset; output pin otherwise.  
See "Reference Circuit" section for pull-up/pull-down and float information.
- Some devices may drive MII pins that are designated as output (PHY) on power-up, resulting in incorrect strapping values latched at reset. It is recommended that an external pull-down via 1kΩ resistor be used in these applications to augment the 8721's internal pull-down.

## Functional Description

### 100BASE-TX Transmit

The 100BASE-TX transmit function performs parallel to serial conversion, NRZ-to-NRZI conversion, and MLT-3 encoding and transmission. The circuitry starts with a parallel to serial conversion that converts the 25MHz, 4-bit nibbles into a 125MHz serial bit stream. The incoming data is clocked in at the positive edge of the TXC signal. The serialized data is further converted from NRZ to NRZI format, and then transmitted in MLT3 current output. The output current is set by an external 1% 6.49k $\Omega$  resistor for the 1:1 transformer ratio. Its typical rise/fall time of 4ns complies with the ANSI TP-PMD standard regarding amplitude balance, overshoot, and timing jitter. The wave-shaped 10BASE-T output driver is also incorporated into the 100BASE-TX driver.

### 100BASE-TX Receive

The 100BASE-TX receive function performs adaptive equalization, DC restoration, MLT-3 to NRZI conversion, data and clock recovery, NRZI-to-NRZ conversion, and serial-to-parallel conversion. The receiving side starts with the equalization filter to compensate inter-symbol interference (ISI) over the twisted pair cable. Since the amplitude loss and phase distortion are a function of the length of the cable, the equalizer has to adjust its characteristic to optimize performance. In this design, the variable equalizer will make an initial estimation based on comparisons of incoming signal strength against some known cable characteristics, then tunes itself for optimization. This is an ongoing process and can self-adjust for environmental changes such as temperature variations.

The equalized signal then goes through a DC restoration and data conversion block. The DC restoration circuit is used to compensate for the effects of base line wander and improve dynamic range. The differential data conversion circuit converts the MLT3 format back to NRZI. The slicing threshold is also adaptive.

The clock recovery circuit extracts the 125MHz clock from the edges of the NRZI signal. This recovered clock is then used to convert the NRZI signal into the NRZ format. Finally, the NRZ serial data is converted to 4-bit parallel 4B nibbles. A synchronized 25MHz RXC is generated so that the 4B nibbles are clocked out at the negative edge of RCK25 and is valid for the receiver at the positive edge. When no valid data is present, the clock recovery circuit is locked to the 25MHz reference clock and both TXC and RXC clocks continue to run.

### PLL Clock Synthesizer

The KS8721BL/SL generates 125MHz, 25MHz, and 20MHz clocks for system timing. An internal crystal oscillator circuit provides the reference clock for the synthesizer.

### Scrambler/De-scrambler (100BASE-TX only)

The purpose of the scrambler is to spread the power spectrum of the signal in order to reduce electromagnetic interference (EMI) and baseline wander.

### 10BASE-T Transmit

When TXEN (transmit enable) goes high, data encoding and transmission begins. The KS8721BL/SL continues to encode and transmit data as long as TXEN remains high. The data transmission ends when TXEN goes low. The last transition occurs at the boundary of the bit cell if the last bit is zero, or at the center of the bit cell if the last bit is one. The output driver is incorporated into the 100BASE-T driver to allow transmission with the same magnetics. They are internally wave-shaped and pre-emphasized into outputs with typical 2.5V amplitude. The harmonic contents are at least 27dB below the fundamental when driven by all-ones, Manchester-encoded signal.

### 10BASE-T Receive

On the receive side, input buffer and level detecting squelch circuits are employed. A differential input receiver circuit and a PLL performs the decoding function. The Manchester-encoded data stream is separated into clock signal and NRZ data. A squelch circuit rejects signals with levels less than 300mV or with short pulse widths in order to prevent noise at the RX+ or RX- input from falsely triggering the decoder. When the input exceeds the squelch limit, the PLL locks onto the incoming signal and the KS8721BL/SL decodes a data frame. This activates the carrier sense (CRS) and RXDV signals and makes the receive data (RXD) available. The receive clock is maintained active during idle periods in between data reception.

### **SQE and Jabber Function (10BASE-T only)**

In 10BASE-T operation, a short pulse is put out on the COL pin after each packet is transmitted. This is required as a test of the 10BASE-T transmit/receive path and is called an SQE test. The 10BASE-T transmitter is disabled and COL goes high if TXEN is high for more than 20ms (Jabbering). If TXEN then goes low for more than 250ms, the 10BASE-T transmitter is re-enabled and COL goes low.

### **Auto-Negotiation**

The KS8721BL/SL performs auto-negotiation by hardware strapping option (pin 29) or software (Register 0.12). It automatically chooses its mode of operation by advertising its abilities and comparing them with those received from its link partner whenever auto-negotiation is enabled. It can also be configured to advertise 100BASE-TX or 10BASE-T in either full- or half-duplex mode (please refer to “Auto-Negotiation”). Auto-negotiation is disabled in the FX mode.

During auto-negotiation, the contents of Register 4, coded in fast link pulse (FLP), are sent to its link partner under the conditions of power-on, link-loss, or restart. At the same time, the KS8721BL/SL monitors incoming data to determine its mode of operation. The parallel detection circuit is enabled as soon as either 10BASE-T normal link pulse (NLP) or 100BASE-TX idle is detected. The operation mode is configured based on the following priority:

- Priority 1: 100BASE-TX, full-duplex
- Priority 2: 100BASE-TX, half-duplex
- Priority 3: 10BASE-T, full-duplex
- Priority 4: 10BASE-T, half-duplex

When the KS8721BL/SL receives a burst of FLP from its link partner with three identical link code words (ignoring acknowledge bit), it will store these code words in Register 5 and wait for the next three identical code words. Once the KS8721BL/SL detects the second code words, it then configures itself according to the above-mentioned priority. In addition, the KS8721BL/SL also checks for 100BASE-TX idle or 10BASE-T NLP symbols. If either is detected, the KS8721BL/SL automatically configures to match the detected operating speed.

### **MII Management Interface**

The KS8721BL/SL supports the IEEE 802.3 MII Management Interface, also known as the Management Data Input/Output (MDIO) Interface. This interface allows upper-layer devices to monitor and control the state of the KS8721BL/SL. The MDIO interface consists of the following:

- A physical connection including a data line (MDIO), a clock line (MDC), and an optional interrupt line (INTRPT).
- A specific protocol that runs across the above-mentioned physical connection that allows one controller to communicate with multiple KS8721BL/SL devices. Each KS8721BL/SL is assigned an MII address between 0 and 31 by the PHYAD inputs.
- An internal addressable set of fourteen 16-bit MDIO registers. Registers [0:6] are required and their functions are specified by the IEEE 802.3 specifications. Additional registers are provided for expanded functionality.

The INTRPT pin functions as a management data interrupt in the MII. An active Low or High in this pin indicates a status change on the KS8721BL/SL based on 1fh.9 level control. Register bits at 1bh[15:8] are the interrupt enable bits. Register bits at 1bh[7:0] are the interrupt condition bits. This interrupt is cleared by reading Register 1bh.

### **MII Data Interface**

The data interface consists of separate channels for transmitting data from a 10/100 802.3 compliant Media Access Controller (MAC) to the KS8721BL/SL, and for receiving data from the line. Normal data transmission is implemented in 4B nibble mode (4-bit wide nibbles).

#### *Transmit Clock (TXC)*

The transmit clock is normally generated by the KS8721BL/SL from an external 25MHz reference source at the X1 input. The transmit data and control signals must always be synchronized to the TXC by the MAC. The KS8721BL/SL normally samples these signals on the rising edge of the TXC.

#### *Receive Clock (RXC)*

For 100BASE-TX links, the receive clock is continuously recovered from the line. If the link goes down, and auto-negotiation is disabled, the receive clock operates off the master input clock (X1 or TXC). For 10BASE-T links, the

receive clock is recovered from the line while carrier is active, and operates from the master input clock when the line is idle. The KS8721BL/SL synchronizes the receive data and control signals on the falling edge of RXC in order to stabilize the signals at the rising edge of the clock with 10ns setup and hold times.

#### *Transmit Enable*

The MAC must assert TXEN at the same time as the first nibble of the preamble, and de-assert TXEN after the last bit of the packet.

#### *Receive Data Valid*

The KS8721BL/SL asserts RXDV when it receives a valid packet. Line operating speed and MII mode will determine timing changes in the following way:

- For 100BASE-TX links with the MII in 4B mode, RXDV is asserted from the first nibble of the preamble to the last nibble of the data packet.
- For 10BASE-T links, the entire preamble is truncated. RXDV is asserted with the first nibble of the SFD “5D” and remains asserted until the end of the packet.

#### *Error Signals*

Whenever the KS8721BL/SL receives an error symbol from the network, it asserts RXER and drives “1110” (4B) on the RXD pins. When the MAC asserts TXER, the KS8721BL/SL will drive “H” symbols (a Transmit Error defined in the IEEE 802.3 4B/5B code group) out on the line to force signaling errors.

#### *Carrier Sense (CRS)*

For 100BASE-TX links, a start-of-stream delimiter, or /J/K symbol pair causes assertion of Carrier Sense (CRS). An end-of-stream delimiter, or /T/R symbol pair, causes de-assertion of CRS. The PMA layer will also de-assert CRS if IDLE symbols are received without /T/R, yet in this case RXER will be asserted for one clock cycle when CRS is de-asserted. For 10BASE-T links, CRS assertion is based on reception of valid preamble, and de-assertion on reception of an end-of-frame (EOF) marker.

#### *Collision*

Whenever the line state is half-duplex and the transmitter and receiver are active at the same time, the KS8721BL/SL asserts its collision signal, which is asynchronous to any clock.

### **RMII (Reduced MII) Data Interface**

RMII interface specifies a low-pin count, Reduced Media Independent Interface (RMII) intended for use between Ethernet PHYs and Switch or Repeater ASICs. It is fully compliant with IEEE 802.3u [2].

This interface has the following characteristics:

- It is capable of supporting 10Mbps and 100Mbps data rates.
- A single clock reference is sourced from the MAC to PHY (or from an external source).
- It provides independent 2-bit wide (di-bit) transmit and receive data paths.
- It uses TTL signal levels compatible with common digital CMOS ASIC processes.

### **RMII Signal Definition**

<b>Signal Name</b>	<b>Direction (w/respect to the PHY)</b>	<b>Direction (w/respect to the MAC)</b>	<b>Use</b>
REF_CLK	Input	Input or Output	Synchronous clock reference for receive, transmit and control interface
CRS_DV	Output	Input	Carrier Sense/Receive Data Valid
RXD[1:0]	Output	Input	Receive Data
TX_EN	Input	Output	Transmit Enable
TXD[1:0]	Input	Output	Transmit Data
RX_ER	Output	Input (Not Required)	Receive Error

**Reference Clock (REF\_CLK)**

REF\_CLK is a continuous 50MHz clock that provides the timing reference for CRS\_DV, RXD[1:0], TX\_EN, TXD[1:0], and RX\_E. REF\_CLK is sourced by the MAC or an external source. Switch implementations may choose to provide REF\_CLK as an input or an output depending on whether they provide a REF\_CLK output or rely on an external clock distribution device. Each PHY device must have an input corresponding to this clock but may use a single clock input for multiple PHYs implemented on a single IC.

**Carrier Sense/Receive Data Valid (CRS\_DV)**

CRS\_DV is asserted asynchronously on detection of carrier due to the criteria relevant to the operating mode. That is, in 10BASE-T mode, when squelch is passed or in 100BASE-X mode when 2 noncontiguous zeroes in 10 bits are detected, the carrier is detected.

Loss-of-carrier results in the de-assertion of CRS\_DV synchronous to REF\_CLK. As carrier criteria are met, CRS\_DV remains continuously asserted from the first recovered di-bit of the frame through the final recovered di-bit and is negated prior to the first REF\_CLK that follows the final di-bit.

The data on RXD[1:0] is considered valid once CRS\_DV is asserted. However, since the assertion of CRS\_DV is asynchronous relative to REF\_CLK, the data on RXD[1:0] remains as "00" until proper receive signal decoding takes place (see "Definition of RXD[1:0] Behavior").

**Receive Data [1:0] (RXD[1:0])**

RXD[1:0] transitions synchronously to REF\_CLK. For each clock period in which CRS\_DV is asserted, RXD[1:0] transfers two bits of recovered data from the PHY. In some cases (e.g., before data recovery or during error conditions), a predetermined value for RXD[1:0] is transferred instead of recovered data. RXD[1:0] remains as "00" to indicate idle when CRS\_DV is de-asserted. Values of RXD[1:0] other than "00" when CRS\_DV is de-asserted are reserved for out-of-band signaling (to be defined). Values other than "00" on RXD[1:0] while CRS\_DV is de-asserted are ignored by the MAC/repeater. Upon assertion of CRS\_DV, the PHY ensures that RXD[1:0]=00 until proper receive decoding takes place.

**Transmit Enable (TX\_EN)**

Transmit Enable TX\_EN indicates that the MAC is presenting di-bits on TXD[1:0] on the RMII for transmission. TX\_EN is asserted synchronously with the first nibble of the preamble and remains asserted while all transmitted di-bits are presented to the RMII. TX\_EN is negated prior to the first REF\_CLK following the final di-bit of a frame. TX\_EN transitions synchronously with respect to REF\_CLK.

**Transmit Data [1:0] (TXD[1:0])**

Transmit Data TXD[1:0] transitions synchronously with respect to REF\_CLK. When TX\_EN is asserted, TXD[1:0] are accepted for transmission by the PHY. TXD[1:0] remains as "00" to indicate idle when TX\_EN is de-asserted. Values of TXD[1:0] other than "00" when TX\_EN is de-asserted are reserved for out-of-band signaling (to be defined). Values other than "00" on TXD[1:0] while TX\_EN is de-asserted are ignored by the PHY.

**Collision Detection**

Since the definition of CRS\_DV and TX\_EN both contain an accurate indication of the start of frame, the MAC reliably re-generates the COL signal of the MII by ANDing TX\_EN and CRS\_DV.

During the IPG time following the successful transmission of a frame, the COL signal is asserted by some transceivers as a self-test. The Signal Quality Error (SQE) function is not supported by the reduced MII due to the lack of the COL signal. Historically, SQE was present to indicate that a transceiver located physically remote from the MAC was functioning. Since the reduced MII only supports chip-to-chip connections on a PCB, SQE functionality is not required.

**RX\_ER**

The PHY provides RX\_ER as an output according to the rules specified in IEEE 802.3u [2] (see Clause 24, Figure 24-11– Receive State Diagram). RX\_ER is asserted for one or more REF\_CLK periods to indicate that an error (e.g., a coding error or any error that a PHY is capable of detecting, and that may otherwise be undetectable by the MAC sub-layer) is detected somewhere in the frame presently being transferred from the PHY. RX\_ER transitions synchronously with respect to REF\_CLK. While CRS\_DV is de-asserted, RX\_ER has no effect on the MAC.

**RMII AC Characteristics**

Symbol	Parameter	Min	Typ	Max	Units
	REF_CLK Frequency		50		MHz
	REF_CLK Duty Cycle	35		65	%
t <sub>SU</sub>	TXD[1:0], TX_EN, RXD[1:0], CRS_DV, RXER	4			ns
t <sub>H</sub>	TXD[1:0], TX_EN, RXD[1:0], CRS_DV, RXER Data Hold from REF_CLK Rising Edge	2			ns

**Unused RMII Pins**

Input Pins TXD[2:3] and TXER are pull-down to GND.

Output Pins RXD[2:3] and RXC are no connect.

Note that the RMII pin needs to be pulled up to enable RMII mode.

**Auto-Crossover (Auto-MDI/MDI-X)**

Automatic MDI/MDI-X configuration is intended to eliminate the need for crossover cables between similar devices. The assignment of pinouts for a 10/100 BASE-T crossover function cable is shown below.

This feature eliminates the confusion in applications by allowing the use of both straight and crossover cables. This feature is controlled by register 1f:13. See “Register 1f–100BASE-TX PHY Controller” section for details.

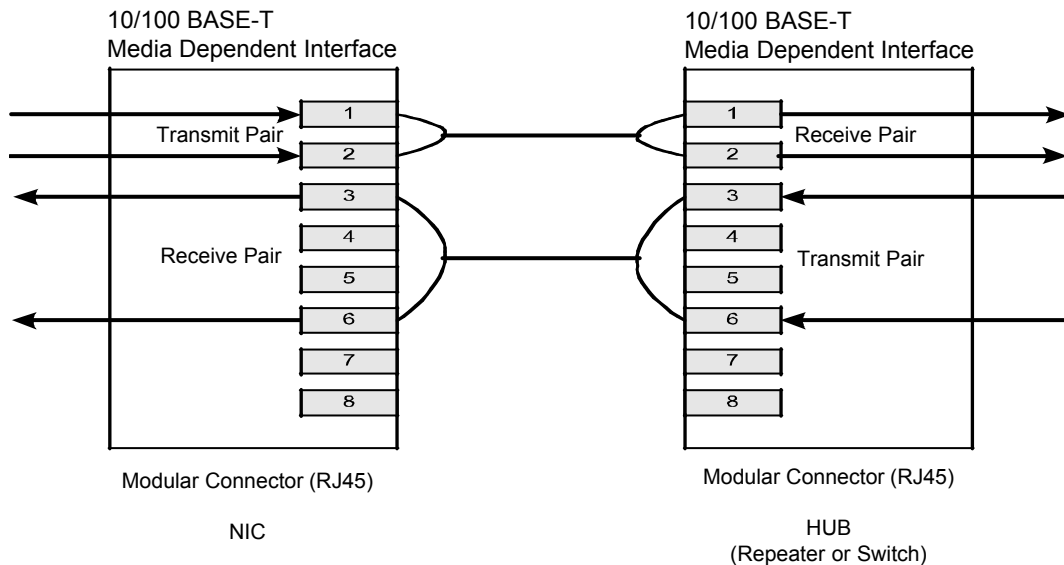

**Figure 1. Straight Through Cable**



Figure 2. Crossover Cable

**Power Management**

The KS8721BL/SL offers the following modes for power management:

- Power-Down Mode: This mode can be achieved by writing to Register 0.11 or pulling pin 30 PD# low.
- Power-Saving Mode: This mode can be disabled by writing to Register 1fh.10. The KS8721BL/SL turns off everything except for the Energy Detect and PLL circuits when the cable is not installed. In other words, the KS8721BL/SL shuts down most of the internal circuits to save power if there is no link. Power-saving mode is in the most effective state when auto-negotiation mode is enabled.

**100BT FX Mode**

Please contact your local field application engineer (FAE) for a reference schematic on fiber connection.

100BT FX mode is activated when FXSD/FXEN is higher than 0.6V (this pin has a default pull down). Under this mode, the auto-negotiation and auto-MDI-X features are disabled.

In fiber operation, the FXSD pin should connect to the signal detect (SD) output of the fiber module. The internal threshold of FXSD is around  $1/2 V_{DD} \pm 50mV$  (1.25V  $\pm 0.05V$ ). Above this level, the fiber signal is considered detected.

The operation is summarized in the following table:

FXSD/FXEN	Condition
Less than 0.6V	100TX mode
Less than 1.25V, but greater than 0.6V	FX mode No signal detected FEF generated
Greater than 1.25	FX mode Signal detected

Table 1. 100BT FX Mode

To ensure proper operation, the swing of fiber module SD should cover the threshold variation. A resistive voltage divider is recommended to adjust the SD voltage range.

Far End Fault (FEF), repetition of a special pattern which consists of 84-one and 1-zero, is generated under “FX mode with no signal detected.” The purpose of FEF is to notify the sender of a faulty link. When receiving an FEF, the LINK will go down to indicate a fault, even with fiber signal detected. The transmitter is not affected by receiving an FEF and



still sends out its normal transmit pattern from MAC. FEF can be disabled by strapping pin 27 low. Refer to the “Strapping Options” section.

**Media Converter Operation**

The KS8721BL/SL is capable of performing media conversion with two parts in a back-to-back RMII loop-back mode as indicated in the diagram. Both parts are in RMII mode and with RMII BTB asserted (pins 21 and 22 strapped high). One part is operating in TX mode and the other is operating in FX mode. Both parts can share a common 50MHz oscillator.

Under this operation, auto-negotiation on the TX side prohibits 10BASE-T link-up. Additional options can be implemented under this operation. Disable the transmitter and set it at tri-state by controlling the high TXD2 pin. In order to do this, RXD2 and TXD2 pins need to be connected via inverter. When TXD2 pin is high in both the copper and fiber operation, it is disabled transmit. Meanwhile, the RXD2 pin on the copper side serves as the energy detect and can indicate if a line signal is detected. TXD3 should be tied low and RXD3 let float. Please contact your Micrel FAE for a media converter reference design.



**Figure 3. Fiber Module**

**Circuit Design Reference for Power Supply**

Micrel’s integrated built-in, voltage regulator technology and thoughtful implementation allows the user to save BOM cost on both existing and future designs with the use of the new KS8721BL/SL single supply, single port 10/100 Ethernet PHY.



**Figure 4. Circuit Design**

The circuit design in Figure 4 shows the power connections for the power supply: the 3.3V to VDDI/O is the only input power source and the 2.5V at VDDRCV, pin 38, is the output of the voltage regulator that needs to supply through the rest of the 2.5V VDD pins via the 2.5V power plane.

The 2.5V VDD pins make the drop-in replacement with the existing KS8721B/BT part. Table 2 shows the drop-in replacement from the existing KS8721B/BT to the KS8721SL/BL. Please contact your local Micrel FAE for Application Note AN-117, “Drop-in Replacement with KS8721BT.”

2.5V/3.3V Supply		3.3V Supply with Built-in Regulator	
Part Number	Package	Part Number	Package
KS8721B	48-SSOP	KS8721SL	48-SSOP
KS8721BT	48-TQFP	KS8721BL	48-LQFP
KS8721BI	48-SSOP	KS8721SLI	48-SSOP

**Table 2. Drop-In Replacement**

## Register Map

Register No.	Description
0h	Basic Control Register
1h	Basic Status Register
2h	PHY Identifier I
3h	PHY Identifier II
4h	Auto-Negotiation Advertisement Register
5h	Auto-Negotiation Link Partner Ability Register
6h	Auto-Negotiation Expansion Register
7h	Auto-Negotiation Next Page Register
8h	Link Partner Next Page Ability
15h	RXER Counter Register
1bh	Interrupt Control/Status Register
1fh	100BASE-TX PHY Control Register

Address	Name	Description	Default <sup>(1)</sup>	Mode
<b>Register 0h - Basic Control</b>				
0.15	Reset	1 = software reset. Bit is self-clearing	RW/SC	0
0.14	Loop-Back	1 = loop-back mode 0 = normal operation	RW	0
0.13	Speed Select (LSB)	1 = 100Mbps 0 = 10Mbps Ignored if Auto-Negotiation is enabled (0.12 = 1)	RW	Set by SPD100
0.12	Auto-Negotiation Enable	1 = enable auto-negotiation process (override 0.13 and 0.8) 0 = disable auto-negotiation process	RW	Set by NWAYEN
0.11	Power Down	1 = power-down mode 0 = normal operation	RW	0
0.10	Isolate	1 = electrical isolation of PHY from MII and TX+/TX- 0 = normal operation	RW	Set by ISO
0.9	Restart Auto-Negotiation	1 = restart auto-negotiation process 0 = normal operation. Bit is self-clearing	RW/SC	0
0.8	Duplex Mode	1 = full-duplex 0 = half-duplex	RW	Set by DUPLEX
0.7	Collision Test	1 = enable COL test 0 = disable COL test	RW	0
0.6:1	Reserved		RO	0
0.0	Disable Transmitter	0 = enable transmitter 1 = disable transmitter	RW	0
<b>Register 1h - Basic Status</b>				
1.15	100BASE-T4	1 = T4 capable 0 = not T4 capable	RO	0
1.14	100BASE-TX Full-Duplex	1 = capable of 100BASE-X full-duplex 0 = not capable of 100BASE-X full-duplex	RO	1

Address	Name	Description	Default <sup>(1)</sup>	Mode
1.13	100BASE-TX Half-Duplex	1 = capable of 100BASE-X half-duplex 0 = not capable of 100BASE-X half-duplex	RO	1
1.12	10BASE-T Full-Duplex	1 = 10Mbps with full-duplex 0 = no 10Mbps with full-duplex capability	RO	1
1.11	10BASE-T Half-Duplex	1 = 10Mbps with half-duplex 0 = no 10Mbps with half-duplex capability	RO	1
1.10:7	Reserved		RO	0
1.6	No Preamble	1 = preamble suppression 0 = normal preamble	RO	1
1.5	Auto-Negotiation Complete	1 = auto-negotiation process completed 0 = auto-negotiation process not completed	RO	0
1.4	Remote Fault	1 = remote fault 0 = no remote fault	RO/LH	0
1.3	Auto-Negotiation Ability	1 = capable to perform auto-negotiation 0 = unable to perform auto-negotiation	RO	1
1.2	Link Status	1 = link is up 0 = link is down	RO/LL	0
1.1	Jabber Detect	1 = jabber detected 0 = jabber not detected. Default is low	RO/LH	0
1.0	Extended Capability	1 = supports extended capabilities registers	RO	1
<b>Register 2h - PHY Identifier 1</b>				
2.15:0	PHY ID Number	Assigned to the 3rd through 18th bits of the organizationally unique identifier (OUI). Micrel's OUI is 0010A1 (hex).	RO	0022h
<b>Register 3h - PHY Identifier 2</b>				
3.15:0	PHY ID Number	Assigned to the 19th through 24th bits of the organizationally unique identifier (OUI). Micrel's OUI is 0010A1 (hex).	RO	000101
3.9:4	Model Number	Six bit manufacturer's model number	RO	100001
3.3:0	Revision Number	Four bit manufacturer's model number	RO	1001
<b>Register 4h - Auto-Negotiation Advertisement</b>				
4.15	Next Page	1 = next page capable 0 = no next page capability	RW	0
4.14	Reserved		RO	0
4.13	Remote Fault	1 = remote fault supported 0 = no remote fault	RW	0
4.12:11	Reserved		RO	0
4.10	Pause	1 = pause function supported 0 = no pause function	RW	0
4.9	100BASE-T4	1 = T4 capable 0 = no T4 capability	RO	0
4.8	100BASE-TX Full-Duplex	1 = TX with full-duplex 0 = no TX full-duplex capability	RW	Set by SPD100 & DUPLEX
4.7	100BASE-TX	1 = TX capable 0 = no TX capability	RW	Set by SPD100
4.6	10BASE-T Full-Duplex	1 = 10Mbps with full-duplex 0 = no 10Mbps full-duplex capability	RW	Set by DUPLEX

Address	Name	Description	Default <sup>(1)</sup>	Mode
4.5	10BASE-T	1 = 10Mbps capable 0 = no 10Mbps capability	RW	1
4.4:0	Selector Field	[00001] = IEEE 802.3	RW	00001
<b>Register 5h - Auto-Negotiation Link Partner Ability</b>				
5.15	Next Page	1 = next page capable 0 = no next page capability	RO	0
5.14	Acknowledge	1 = link code word received from partner 0 = link code word not yet received	RO	0
5.13	Remote Fault	1 = remote fault detected; 0 = no remote fault	RO	0
5.12	Reserved		RO	0
5.11:10	Pause	5.10 5 .11 0 0 <u>No PAUSE</u> 0 1 <u>Asymmetric PAUSE (link partner)</u> 1 0 <u>Symmetric PAUSE</u> 1 1 <u>Symmetric &amp; Asymmetric PAUSE (local device)</u>	RO	0
5.9	100 BASE-T4	1 = T4 capable 0 = no T4 capability	RO	0
5.8	100BASE-TX Full-Duplex	1 = TX with full-duplex 0 = no TX full-duplex capability	RO	0
5.7	100BASE-TX	1 = TX capable 0 = no TX capability	RO	0
5.6	10BASE-T Full-Duplex	1 = 10Mbps with full-duplex 0 = no 10Mbps full-duplex capability	RO	0
5.5	10BASE-T	1 = 10Mbps capable 0 = no 10Mbps capability	RO	0
5.4:0	Selector Field	[00001] = IEEE 802.3	RO	00001
<b>Register 6h - Auto-Negotiation Expansion</b>				
6.15:5	Reserved		RO	0
6.4	Parallel Detection Fault	1 = fault detected by parallel detection 0 = no fault detected by parallel detection	RO/LH	0
6.3	Link Partner Next Page Able	1 = link partner has next page capability 0 = link partner does not have next page capability	RO	0
6.2	Next Page Able	1 = local device has next page capability 0 = local device does not have next page capability	RO	1
6.1	Page Received	1 = new page received 0 = new page not yet received	RO/LH	0
6.0	Link Partner Auto-Negotiation Able	1 = link partner has auto-negotiation capability 0 = link partner does not have auto-negotiation capability	RO	0
<b>Register 7h - Auto-Negotiation Next Page</b>				
7.15	Next Page	1 = additional next page(s) will follow 0 = last page	RW	0
7.14	Reserved		RO	0
7.13	Message Page	1 = message page 0 = unformatted page	RW	1

Address	Name	Description	Default <sup>(1)</sup>	Mode
7.12	Acknowledge 2	1 = will comply with message 0 = cannot comply with message	RW	0
7.11	Toggle	1 = previous value of the transmitted link code word equaled logic One 0 = logic Zero	RO	0
7.10:0	Message Field	11-bit wide field to encode 2048 messages	RW	001
<b>Register 8h - Link Partner Next Page Ability</b>				
8.15	Next Page	1 = additional next page(s) will follow 0 = last page	RO	0
8.14	Acknowledge	1 = successful receipt of link word 0 = no successful receipt of link word	RO	0
8.13	Message Page	1 = Message Page 0 = unformatted page	RO	0
8.12	Acknowledge 2	1 = able to act on the information 0 = not able to act on the information	RO	0
8.11	Toggle	1 = previous value of transmitted link code word equal to logic zero 0 = previous value of transmitted link code word equal to logic one	RO	0
8.10:0	Message Field		RO	0
<b>Register 15h - RXER Counter</b>				
15.15:0	RXER Counter	RX Error counter for the RX_ER in each package	RO	000
<b>Register 1bh - Interrupt Control/Status Register</b>				
1b.15	Jabber Interrupt Enable	1 = Enable jabber interrupt 0 = Disable jabber interrupt	RW	0
1b.14	Receive Error Interrupt Enable	1 = Enable receive error interrupt 0 = Disable receive error interrupt	RW	0
1b.13	Page Received Interrupt Enable	1 = Enable page received interrupt 0 = Disable page received interrupt	RW	0
1b.12	Parallel Detect Fault Interrupt Enable	1 = Enable parallel detect fault interrupt 0 = Disable parallel detect fault interrupt	RW	0
1b.11	Link Partner Acknowledge Interrupt Enable	1 = Enable link partner acknowledge interrupt 0 = Disable link partner acknowledge interrupt	RW	0
1b.10	Link Down Interrupt Enable	1 = Enable link down interrupt 0 = Disable link down interrupt	RW	0
1b.9	Remote Fault Interrupt Enable	1 = Enable remote fault interrupt 0 = Disable remote fault interrupt	RW	0
1b.8	Link Up Interrupt Enable	1 = Enable link up interrupt 0 = Disable link up interrupt	RW	0
1b.7	Jabber Interrupt	1 = Jabber interrupt occurred 0 = Jabber interrupt has not occurred	RO/SC	0
1b.6	Receive Error Interrupt	1 = Receive error occurred 0 = Receive error has not occurred	RO/SC	0
1b.5	Page Receive Interrupt	1 = Page receive occurred 0 = Page receive has not occurred	RO/SC	0
1b.4	Parallel Detect Fault Interrupt	1 = Parallel detect fault occurred 0 = Parallel detect fault has not occurred	RO/SC	0

Address	Name	Description	Default <sup>(1)</sup>	Mode
1b.3	Link Partner Acknowledge Interrupt	1 = Link partner acknowledge occurred 0 = Link partner acknowledge has not occurred	RO/SC	0
1b.2	Link Down Interrupt	1 = Link down occurred 0 = Link down has not occurred	RO/SC	0
1b.1	Remote Fault Interrupt	1 = Remote fault occurred 0 = Remote fault has not occurred	RO/SC	0
1b.0	Link Up Interrupt	1 = Link up interrupt occurred 0 = Link up interrupt has not occurred	RO/SC	0
<b>Register 1fh - 100BASE-TX PHY Controller</b>				
1f.15:14	Reserved		RO	0
1f.13	Pairswap Disable	1 = Disable MDI/MDI-X 0 = Enable MDI/MDI-X	RW	0
1f.12	Energy Detect	1 = Presence of signal on RX+/RX- analog wire pair 0 = No signal detected on RX+/RX-	RO	0
1f.11	Force Link	1 = Force link pass 0 = Normal link operation This bit bypasses the control logic and allow transmitter to send pattern even if there is no link.	RW	0
1f.10	Power-Saving	1 = Enable power-saving 0 = Disable	RW	1
1f.9	Interrupt Level	1 = Interrupt pin active high 0 = Active low	RW	0
1f.8	Enable Jabber	1 = Enable jabber counter 0 = Disable	RW	1
1f.7	Auto-Negotiation Complete	1 = Auto-negotiation complete 0 = Not complete	RW	0
1f.6	Enable Pause (Flow-Control Result)	1 = Flow control capable 0 = No flow control	RO	0
1f.5	PHY Isolate	1 = PHY in isolate mode 0 = Not isolated	RO	0
1f.4:2	Operation Mode Indication	[000] = Still in auto-negotiation [001] = 10BASE-T half-duplex [010] = 100BASE-TX half-duplex [011] = Reserved [101] = 10BASE-T full-duplex [110] = 100BASE-TX full-duplex [111] = PHY/MII isolate	RO	0
1f.1	Enable SQE Test	1 = Enable SQE test 0 = Disable	RW	0
1f.0	Disable Data Scrambling	1 = Disable scrambler 0 = Enable	RW	0

**Note:**

1. RW = Read/Write.  
RO = Read Only.  
SC = Self Clear.  
LH = Latch High.  
LL = Latch Low.

Some of the default values are set by strap-in. See "Strapping Options."

### Absolute Maximum Ratings<sup>(1)</sup>

Storage Temperature (T<sub>s</sub>) ..... -55°C to +150°C  
 Supply Referenced to GND..... -0.5V to +4.0V  
 All Pins ..... -0.5V to +4.0V

### Operating Ratings<sup>(2)</sup>

Supply Voltage  
 (V<sub>DD\_PLL</sub>, V<sub>DD\_TX</sub>, V<sub>DD\_RXC</sub>, V<sub>DD\_RCV</sub>, V<sub>DDC</sub>) ..... +2.5V  
 (V<sub>DDIO</sub>)..... +3.3V  
 Ambient Temperature (T<sub>A</sub>)  
 Commercial ..... 0°C to +70°C  
 Industrial ..... -40°C to +85°C  
 Package Thermal Resistance<sup>(3)</sup>  
 LQFP(θ<sub>JA</sub>)  
 No Airflow ..... 83.56°C/W  
 SSOP(θ<sub>JA</sub>)  
 No Airflow ..... 75.19°C/W

### Electrical Characteristics<sup>(4)</sup>

V<sub>DD</sub> = 3.3V ±10%

Symbol	Parameter	Condition	Min	Typ	Max	Units
<b>Total Supply Current (including TX output driver current)<sup>(5)</sup></b>						
I <sub>DD1</sub>	Normal 100BASE-TX	Including 43mA output current		116		mA
I <sub>DD2</sub>	Normal 100BASE-TX (Independent of utilization)	Including 103mA output current		151		mA
I <sub>DD3</sub>	Power Saving Mode 1	Auto-negotiation is Enable		47		mA
I <sub>DD5</sub>	Power Down Mode			4		mA
<b>TTL Inputs</b>						
V <sub>IH</sub>	Input High Voltage		1/2V <sub>DD(I/O)</sub> +0.2			V
V <sub>IL</sub>	Input Low Voltage				0.8	V
I <sub>IN</sub>	Input Current	V <sub>IN</sub> = GND ~ V <sub>DDIO</sub>	-10		10	µA
<b>TTL Outputs</b>						
V <sub>OH</sub>	Output High Voltage	I <sub>OH</sub> = -4mA	1/2V <sub>DD(I/O)</sub> +0.6			V
V <sub>OL</sub>	Output Low Voltage	I <sub>OL</sub> = 4mA			0.4	V
I <sub>OZ</sub>	Output Tri-state Leakage				10	µA
<b>100Base-TX Receive</b>						
R <sub>IN</sub>	RX+/RX- Differential Input Resistance			8		kΩ
	Propagation Delay	from magnetics to RDTX		50	110	ns
<b>10Base-TX Transmit (measured differentially after 1:1 transformer)</b>						
V <sub>O</sub>	Peak Differential Output Voltage	50Ω from each output to V <sub>DD</sub>	0.95		1.05	V
V <sub>IMB</sub>	Output Voltage Imbalance	50Ω from each output to V <sub>DD</sub>			2	%
t <sub>r</sub> , t <sub>f</sub>	Rise/Fall Time		3		5	ns
	Rise/Fall Time Imbalance		0		0.5	ns
	Duty Cycle Distortion				±0.5	ns
	Overshoot				5	%
V <sub>SET</sub>	Reference Voltage of ISET			0.75		V
	Propagation Delay	from TDTX to magentics		45	60	ns
	Jitters			0.7	1.4	ns(pp)



<b>10Base-TX Receive</b>						
$R_{IN}$	RX+/RX- Differential Input Resistance			8		kW
$V_{SQ}$	Squelch Threshold	5MHz square wave		400		mV
<b>10Base-TX Transmit (measured differentially after 1:1 transformer)</b>						
$V_P$	Peak Differential Output Voltage	50W from each output to $V_{DD}$	2.2		2.8	V
	Jitters Added	50W from each output to $V_{DD}$			$\pm 3.5$	ns
$t_r, t_f$	Rise/Fall Time			25		ns
<b>Clock Outputs</b>						
X1, X2	Crystal Oscillator			25		MHz
$RXC_{100}$	Receive Clock, 100TX			25		MHz
$RXC_{10}$	Receive Clock, 10T			2.5		MHz
	Receive Clock Jitters			3.0		ns <sub>(pp)</sub>
$TXC_{100}$	Transmit Clock, 100TX			25		MHz
$TXC_{10}$	Transmit Clock, 10T			2.5		MHz
	Transmit Clock Jitters			1.8		ns <sub>(pp)</sub>

**Notes:**

1. Exceeding the absolute maximum rating may damage the device. Operating at maximum conditions for extended periods may affect device reliability.
2. The device is not guaranteed to function outside its operating rating. Unused inputs must always be tied to an appropriate logic voltage level (Ground to  $V_{DD}$ )
3. No (HS) heat spreader in this package.
4. Specification for packaged product only.
5. There is 100% data transmission in full-duplex mode and a minimum IPG with a 130-meter cable.

## Timing Diagrams



Figure 4. 10BASE-T MII Transmit Timing

Symbol	Parameter	Min	Typ	Max	Units
$t_{SU1}$	TXD [3:0] Set-Up to TXC High	10			ns
$t_{SU2}$	TXEN Set-Up to TXC High	10			ns
$t_{LD1}$	TXD [3:0] Hold After TXC High	0			ns
$t_{LD2}$	TXEN Hold After TXC High	0			ns
$t_{CR1}$	TXEN High to CRS Asserted Latency		4		BT <sup>(1)</sup>
$t_{CR2}$	TXEN Low to CRS De-Asserted Latency		8		BT
$t_{LAT}$	TXEN High to TXP/TXM Output (TX Latency)		4		BT
$t_{SQE}$	COL (SQE) Delay After TXEN De-Asserted		2.5		$\mu$ s
$t_{SQEP}$	COL (SQE) Pulse Duration		1.0		$\mu$ s

Table 3. 10BASE-T MII Transmit Timing Parameters

Note:

- 1BT = 10ns at 10BASE-TX



Figure 5. 100BASE-T MII Transmit Timing

Symbol	Parameter	Min	Typ	Max	Units
$t_{SU1}$	TXD [3:0] Set-Up to TXC High	10			ns
$t_{SU2}$	TXEN Set-Up to TXC High	10			ns
$t_{HD1}$	TXD [3:0] Hold After TXC High	0			ns
$t_{HD2}$	TXER Hold After TXC High	0			ns
$t_{HD3}$	TXEN Hold After TXC High	0			ns
$t_{CRS1}$	TXEN High to CRS Asserted Latency		4		BT <sup>(1)</sup>
$t_{CRS2}$	TXEN Low to CRS De-Asserted Latency		4		BT
$t_{LAT}$	TXEN High to TXP/TXM Output (TX Latency)		9		BT

Table 4. 100BASE-T MII Transmit Timing Parameters

Note:

- 1BT = 10ns at 100BASE-TX



Figure 6. 100BASE-T MII Receive Timing

Symbol	Parameter	Min	Typ	Max	Units
$t_P$	RXC Period		40		ns
$t_{WL}$	RXC Pulse Width	20			ns
$t_{WH}$	RXC Pulse Width	20			ns
$t_{SU}$	RXD [3:0], RXER, RXDV Set-Up to Rising Edge of RXC		20		ns
$t_{HD}$	RXD [3:0], RXER, RXDV Hold from Rising Edge of RXC		20		ns
$t_{RLAT}$	CRS to RXD Latency, 4B or 5B Aligned		6		BT
$t_{CRS1}$	“Start of Stream” to CSR Asserted	106		138	ns
$t_{CRS2}$	“End of Stream” to CSR De-Asserted	154		186	ns

Table 5. 100BASE-T MII Receive Timing Parameters

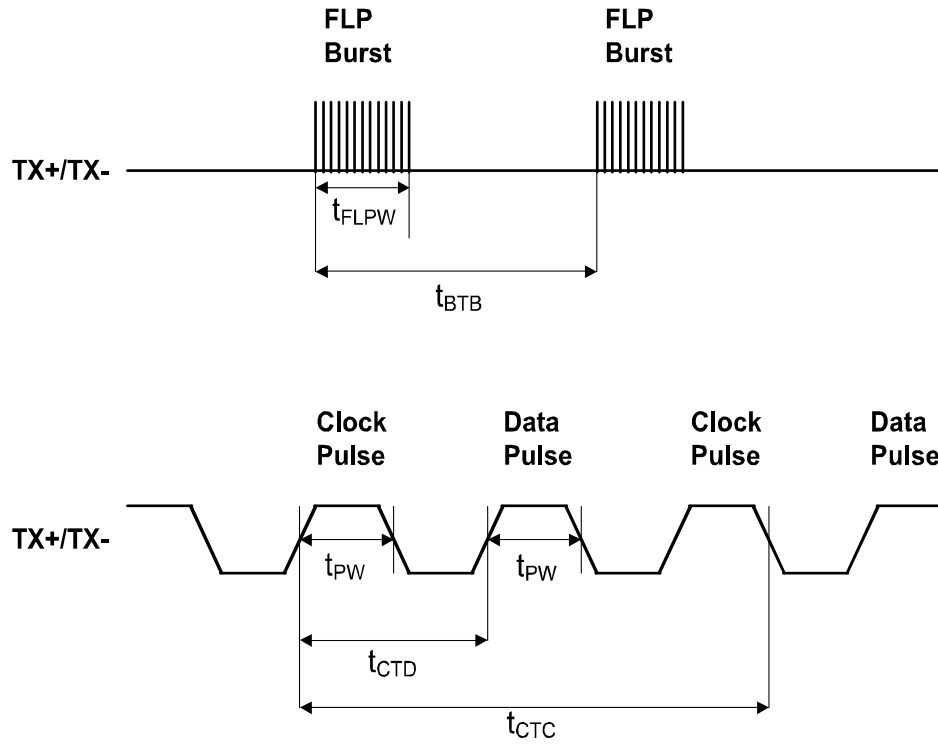

Figure 7. Auto-Negotiation/Fast Link Pulse Timing

Symbol	Parameter	Min	Typ	Max	Units
$t_{BTB}$	FLP Burst to FLP Burst	8	16	24	ms
$t_{FLPW}$	FLP Burst Width		2		ms
$t_{PW}$	Clock/Data Pulse Width		100		ns
$t_{CTD}$	Clock Pulse to Data Pulse		69		$\mu$ s
$t_{CTC}$	Clock Pulse to Clock Pulse Number of Clock/Data Pulses per Burst	17	136	33	$\mu$ s $\mu$ s

Table 6. Auto-Negotiation/Fast Link Pulse Timing Parameters



Figure 8. Serial Management Interface Timing

Symbol	Parameter	Min	Typ	Max	Units
$t_P$	MDC Period		400		ns
$t_{MD1}$	MDIO Set-Up to MDC (MDIO as Input)	10			ns
$t_{MD2}$	MDIO Hold After MDC (MDIO as Input)	10			ns
$t_{MD3}$	MDC to MDIO Valid (MDIO as Output)		222		ns

Table 7. Serial Management Interface Timing Parameters



Figure 9. Reset Timing

Symbol	Parameter	Min	Typ	Max	Units
$t_{sr}$	Stable Supply Voltages to Reset High	50			$\mu s$

Table 8. Reset Timing Parameters

**Reset Circuit Diagram**

Micrel recommends the following discrete reset circuit as shown in Figure 10 when powering up the KS8721BL/SL device. For the application where the reset circuit signal comes from another device (e.g., CPU, FPGA, etc), we recommend the reset circuit as shown in Figure 11.



Figure 10. Recommended Reset Circuit



**Figure 11. Recommended Circuit for Interfacing with CPU/FPGA Reset**

At power-on-reset, R, C, and D1 provide the necessary ramp rise time to reset the Micrel device. The reset out from CPU/FPGA provides warm reset after power up. It is also recommended to power up the VDD core voltage earlier than VDDIO voltage. At worst case, the both VDD core and VDDIO voltages should come up at the same time.

**Reference Circuit for Strapping Option Configuration**

Figure 12 shows the reference circuit for strapping option pins.



Reference circuits for unmanaged programming through LED ports.

**Figure 12. Reference Circuit, Strapping Option Pins**



## Selection of Isolation Transformers<sup>(1)</sup>

One simple 1:1 isolation transformer is needed at the line interface. An isolation transformer with integrated common-mode choke is recommended for exceeding FCC requirements. The following table gives recommended transformer characteristics.

Parameter	Value	Test Condition
Turns ratio	1 CT : 1 CT	
Open-circuit inductance (min)	350 $\mu$ H	100mV, 100kHz, 8mA
Leakage inductance (max)	0.4 $\mu$ H	1MHz (min)
Inter-winding capacitance (max)	12pF	
D.C. resistance (max)	0.9 $\Omega$	
Insertion loss (max)	1.0dB	0MHz – 65MHz
HIPOT (min)	1500Vrms	

### Note:

- The IEEE 802.3u standard for 100BASE-TX assumes a transformer loss of 0.5dB. For the transmit line transformer, insertion loss of up to 1.3dB can be compensated or by increasing the line drive current by means of reducing the ISET resistor value. Please select the transformer that supports auto-MDI/MDI-X.

## Selection of Reference Crystal

An oscillator or crystal with the following typical characteristics is recommended.

Characteristics	Value	Units
Frequency	25	MHz
Frequency tolerance (max)	$\pm$ 100	ppm
Load capacitance (max)	20	pF
Series resistance (max)	40	$\Omega$

Single Port Magnetic Manufacturer	Part Number	Auto MDIX	Number of Ports
Pulse	H1102	Yes	1
Bel Fuse	S558-5999-U7	Yes	1
YCL	PT163020	Yes	1
Transpower	HB726	Yes	1
Delta	LF8505	Yes	1
LanKom	LF-H41S	Yes	1
Integrated Transformers			
Pulse	J0011D21	Yes	1
Pulse	J00-0061	Yes	1

Table 9. Qualified Transformer Lists

**Package Information**

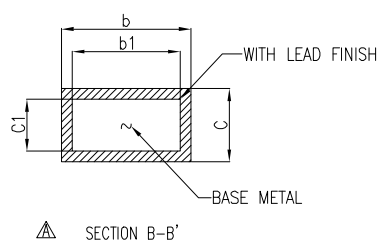
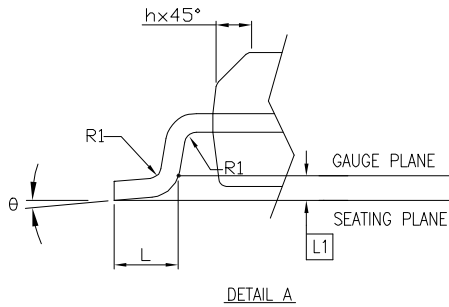

SYMBOL	DIMENSION IN MM			DIMENSION IN INCH		
	MIN.	NOM	MAX.	MIN.	NOM	MAX.
A	2.413	2.591	2.794	0.095	0.102	0.110
A1	0.203	0.305	0.406	0.008	0.012	0.016
b	0.203		0.343	0.008		0.014
b1	0.203	0.254	0.305	0.008	0.010	0.012
c	0.127		0.254	0.005		0.010
c1	0.127		0.216	0.005		0.009
E	10.058	10.312	10.566	0.396	0.406	0.416
E1	7.391	7.493	7.595	0.291	0.295	0.299
e	0.635 BASIC			0.025 BASIC		
h	0.381		0.635	0.015		0.025
L	0.508		1.016	0.020		0.040
L1	0.254 BASIC			0.010 BASIC		
R1						
θ	0		5	0		5

N	D (MM)			JEDEC
	MIN.	NOM	MAX.	
48	15.748	15.875	16.002	MO-118AA
56	18.288	18.415	18.542	MO-118AB

**48-Pin SSOP (SM)**

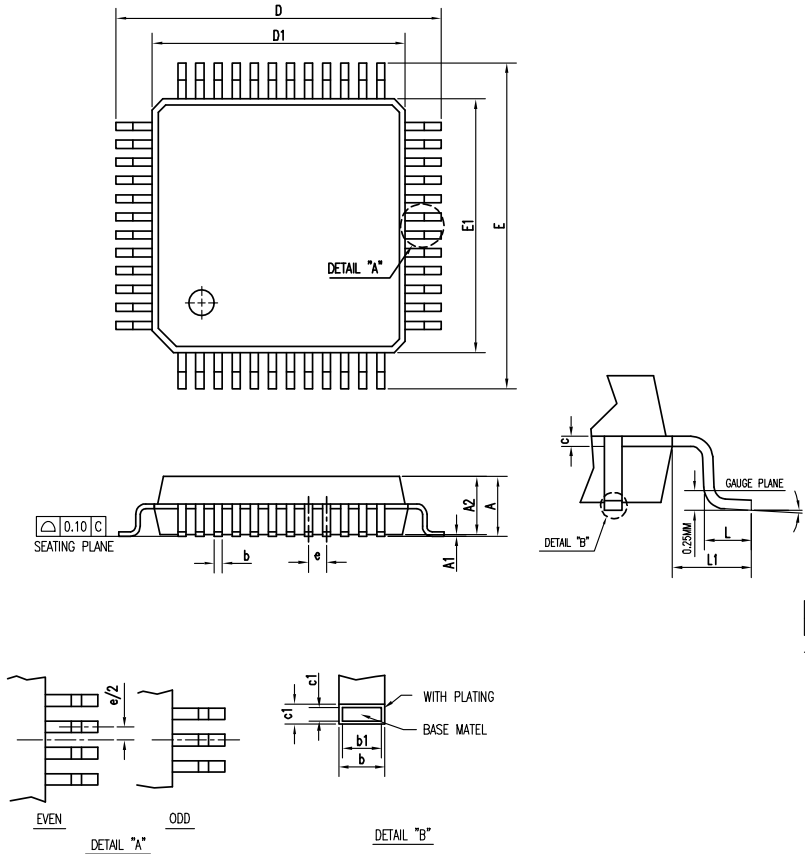

SYMBOL	DIMENSION IN MM			DIMENSION IN INCH		
	MIN.	NOM	MAX.	MIN.	NOM	MAX.
A			1.60			0.063
A1	0.05		0.15	0.002		0.006
A2	1.35	1.40	1.45	0.053	0.055	0.057
D	8.90	9.00	9.10	0.350	0.354	0.358
D1	6.90	7.00	7.10	0.272	0.276	0.280
E	8.90	9.00	9.10	0.350	0.354	0.358
E1	6.90	7.00	7.10	0.272	0.276	0.280
c	0.129 TYP.			0.007 TYP.		
c1	0.127 TYP.			0.005 TYP.		
L	0.50	0.60	0.70	0.020	0.024	0.028
L1	1.00 REF.			0.039 REF.		
θ	0	3.5	7	0	3.5	7
JEDEC						

N	b (MM)			b1 (MM)			e (MM)			JEDEC
	MIN.	NOM	MAX.	MIN.	NOM	MAX.	MIN.	NOM	MAX.	
48L	0.19	0.22	0.25	0.17	0.20	0.23	0.50 BSC.			

**48-Pin LQFP (LQ)**

**MICREL, INC. 2180 FORTUNE DRIVE SAN JOSE, CA 95131 USA**  
 TEL +1 (408) 944-0800 FAX +1 (408) 474-1000 WEB <http://www.micrel.com>

The information furnished by Micrel in this data sheet is believed to be accurate and reliable. However, no responsibility is assumed by Micrel for its use. Micrel reserves the right to change circuitry and specifications at any time without notification to the customer.

Micrel Products are not designed or authorized for use as components in life support appliances, devices or systems where malfunction of a product can reasonably be expected to result in personal injury. Life support devices or systems are devices or systems that (a) are intended for surgical implant into the body or (b) support or sustain life, and whose failure to perform can be reasonably expected to result in a significant injury to the user. A Purchaser's use or sale of Micrel Products for use in life support appliances, devices or systems is a Purchaser's own risk and Purchaser agrees to fully indemnify Micrel for any damages resulting from such use or sale.

© 2004 Micrel, Incorporated.

## Данный компонент на территории Российской Федерации

### Вы можете приобрести в компании MosChip.

Для оперативного оформления запроса Вам необходимо перейти по данной ссылке:

<http://moschip.ru/get-element>

Вы можете разместить у нас заказ для любого Вашего проекта, будь то серийное производство или разработка единичного прибора.

В нашем ассортименте представлены ведущие мировые производители активных и пассивных электронных компонентов.

Нашей специализацией является поставка электронной компонентной базы двойного назначения, продукции таких производителей как XILINX, Intel (ex.ALTERA), Vicor, Microchip, Texas Instruments, Analog Devices, Mini-Circuits, Amphenol, Glenair.

Сотрудничество с глобальными дистрибьюторами электронных компонентов, предоставляет возможность заказывать и получать с международных складов практически любой перечень компонентов в оптимальные для Вас сроки.

На всех этапах разработки и производства наши партнеры могут получить квалифицированную поддержку опытных инженеров.

Система менеджмента качества компании отвечает требованиям в соответствии с ГОСТ Р ИСО 9001, ГОСТ РВ 0015-002 и ЭС РД 009

### Офис по работе с юридическими лицами:

105318, г.Москва, ул.Щербаковская д.3, офис 1107, 1118, ДЦ «Щербаковский»

Телефон: +7 495 668-12-70 (многоканальный)

Факс: +7 495 668-12-70 (доб.304)

E-mail: [info@moschip.ru](mailto:info@moschip.ru)

Skype отдела продаж:

moschip.ru

moschip.ru\_4

moschip.ru\_6

moschip.ru\_9