

Data Sheet

Overview

The Broadcom[®] ASMW-FWGO surface-mount LEDs use InGaN chip technology with superior package design to enable them to produce higher light output with better flux performance. They can be driven at high current and are able to dissipate the heat more efficiently, which results in better performance with higher reliability.

These LEDs can operate under a wide range of environmental conditions, making them ideal for various applications, including fluorescent replacement, under-cabinet lighting, retail display lighting, and panel lights.

To facilitate easy pick-and-place assembly, the LEDs are packed in tape and reel. Every reel is shipped in single flux and color bin to provide close uniformity.

Features

- Available in 3000K, 4000K and 6500K per ANSI
- CRI \geq 80
- Moisture Sensitivity Level 3
- High reliability with silicone encapsulation
- Low package profile and large emitting area for better uniformity in linear lighting

Applications

- For lighting and luminaires
- Channel letter and advertisement board backlighting
- Office automation, home appliances, industrial equipment
 - Front panel backlighting
 - Pushbutton backlighting
 - Display backlighting
 - Scanner lighting

CAUTION: This LED is ESD sensitive. Please observe appropriate precautions during handling and processing. Refer to Application Note AN-1142 for additional details.

Figure 1 Package Dimensions

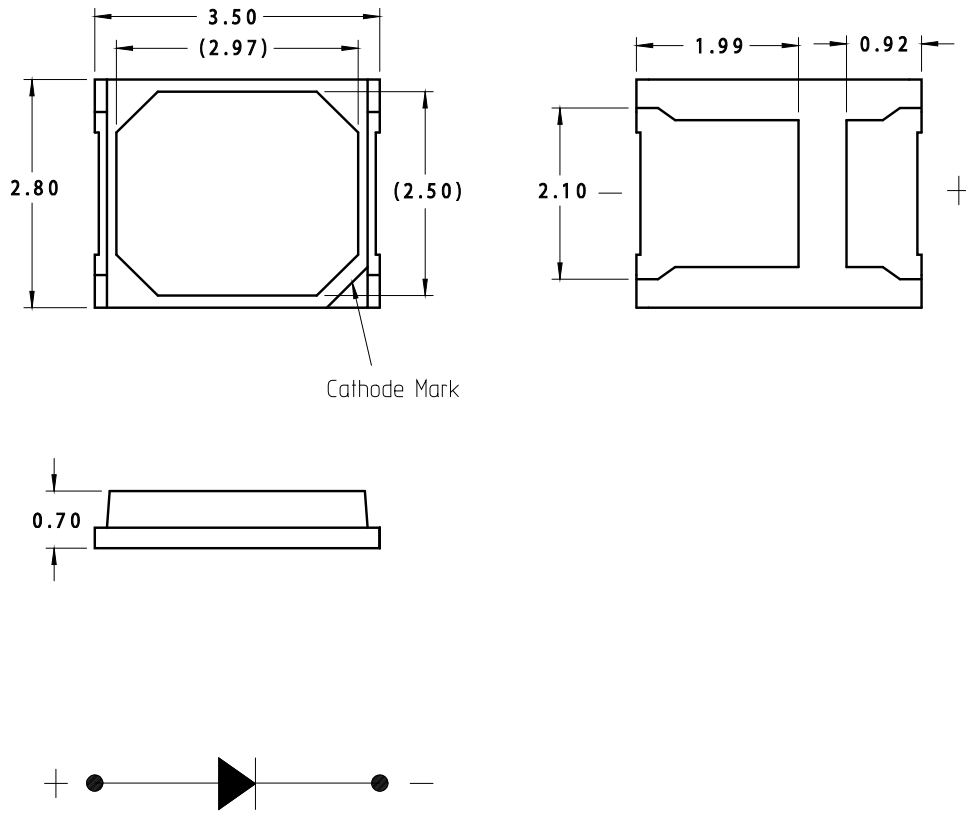

NOTE

1. All dimensions are in mm.
2. Tolerance is ± 0.20 mm unless otherwise specified.
3. Encapsulation = silicone.
4. Terminal finish = silver plating.
5. Dimensions in brackets are for reference only.

Device Selection Guide ($T_J = 25^\circ\text{C}$, $I_F = 60\text{ mA}$)

Part Number	Correlated Color Temperature, CCT (Kelvin)	Luminous Flux Φ_V (lm) ^{a, b}			Luminous Intensity (cd) ^c
	Typ.	Min.	Typ.	Max.	Typ.
ASMW-FWG0-NHKKH6	3000	19.0	21.5	24.0	7.2
ASMW-FWG0-NJLH6	3000	20.0	24.5	26.0	8.2
ASMW-FWG0-NJLF6	4000	20.0	23.0	26.0	7.7
ASMW-FWG0-NKMF6	4000	22.0	25.5	28.0	8.5
ASMW-FWG0-NJLB6	6500	20.0	23.0	26.0	7.7
ASMW-FWG0-NKMB6	6500	22.0	25.5	28.0	8.5

- a. The luminous flux, Φ_V , is measure at the mechanical axis of the package, and it is tested with a single current pulse condition.
 b. Tolerance = $\pm 12\%$.
 c. For reference only.

Absolute Maximum Ratings

Parameter	ASMW-FWG0-Nxxx6	Units
DC Forward Current ^a	100	mA
Peak Forward Current ^b	180	mA
Power Dissipation	330	mW
Reverse Voltage	Not designed for reverse bias operation	
LED Junction Temperature	125	$^\circ\text{C}$
Operating Temperature Range	-40 to +100	$^\circ\text{C}$
Storage Temperature Range	-40 to +100	$^\circ\text{C}$

- a. Derate linearly as shown in [Figure 15](#) and [Figure 16](#).
 b. Duty factor = 10%, frequency = 1 kHz.

Optical and Electrical Characteristics ($T_J = 25^\circ\text{C}$, $I_F = 60\text{ mA}$)

Parameter	Min.	Typ.	Max.	Units
Viewing Angle, $\theta_{1/2}$ ^a	—	120	—	$^\circ$
Forward Voltage, V_F ^b	2.80	2.92	3.30	V
Reverse Current, I_R at $V_R = 5\text{V}$ ^c	—	—	10	μA
Color Rendering Index, CRI	80	—	—	—
Thermal Resistance, $R_{\theta J-S}$ ^d	—	40	—	$^\circ\text{C}/\text{W}$

- a. $\theta_{1/2}$ is the off axis angle where the luminous intensity is half of the peak intensity.
 b. Forward voltage tolerance is $\pm 0.1\text{V}$.
 c. Indicates production final test condition only. Long term reverse bias is not recommended.
 d. Thermal resistance from the LED junction to the solder point.

Performance Characteristics (T_J = 25°C)

Forward Current (mA)	Relative Luminous Flux (Normalized at 60 mA)	Luminous Flux, Φ_V (lm)	Forward Voltage, V _F (V)	Luminous Efficiency (lm/W)
		Typ.	Typ.	Typ.
ASMW-FWG0-NHKH6				
20	0.367	7.9	2.74	144.2
30	0.537	11.5	2.80	137.6
40	0.698	15.0	2.84	132.1
50	0.852	18.3	2.88	127.3
60 (Test current)	1.000	21.5	2.92	122.7
65	1.072	23.0	2.94	120.6
70	1.142	24.6	2.96	118.5
80	1.279	27.5	2.99	115.1
90	1.411	30.3	3.02	111.8
100	1.538	33.1	3.04	108.7
ASMW-FWG0-NJLF6, ASMW-FWG0-NJLB6				
20	0.367	8.5	2.74	154.2
30	0.537	12.3	2.80	147.2
40	0.698	16.1	2.84	141.3
50	0.852	19.6	2.88	136.1
60 (Test current)	1.000	23.0	2.92	131.3
65	1.072	24.7	2.94	129.0
70	1.142	26.3	2.96	126.8
80	1.279	29.4	2.99	123.2
90	1.411	32.5	3.02	119.6
100	1.538	35.4	3.04	116.2
ASMW-FWG0-NJLH6				
20	0.367	9.0	2.74	164.3
30	0.537	13.2	2.80	156.9
40	0.698	17.1	2.84	150.6
50	0.852	20.9	2.88	145.0
60 (Test current)	1.000	24.5	2.92	139.9
65	1.072	26.3	2.94	137.4
70	1.142	28.0	2.96	135.1
80	1.279	31.3	2.99	131.2
90	1.411	34.6	3.02	127.4
100	1.538	37.7	3.04	123.8

Forward Current (mA)	Relative Luminous Flux (Normalized at 60 mA)	Luminous Flux, Φ_V (lm)	Forward Voltage, V_F (V)	Luminous Efficiency (lm/W)
		Typ.	Typ.	Typ.
ASMW-FWG0-NKMF6, ASMW-FWG0-NKMB6				
20	0.367	9.4	2.74	171.0
30	0.537	13.7	2.80	163.3
40	0.698	17.8	2.84	156.7
50	0.852	21.7	2.88	150.9
60 (Test current)	1.000	25.5	2.92	145.6
65	1.072	27.3	2.94	143.0
70	1.142	29.1	2.96	140.6
80	1.279	32.6	2.99	136.6
90	1.411	36.0	3.02	132.6
100	1.538	39.2	3.04	128.9

Part Numbering System

A S M W - F W x₁ 0 - N x₂ x₃ x₄ x₅

Code	Description	Options	
x ₁	Color Rendering Index	G	CRI ≥ 80
x ₂	Minimum Flux Bin	Refer to Flux Bin Limits (CAT) taboe	
x ₃	Maximum Flux Bin		
x ₄	Color Bin	H	3000K
		F	4000K
		B	6500K
x ₅	Test Option	6	Test current = 60 mA

Part Number Example

ASMW-FWG0-NJLH6

- x₁: G - CRI ≥ 80
- x₂: J - Minimum flux bin J
- x₃: L - Maximum flux bin L
- x₄: H - CCT 3000K withbins 8A, 8B, 8C, 8D
- x₅: 6 - Test current = 60 mA

Bin Information

Flux Bin Limits (CAT)

Bin ID	Luminous Flux, Φ_V (lm)	
	Min.	Max.
H	19.0	20.0
J	20.0	22.0
K	22.0	24.0
L	24.0	26.0
M	26.0	28.0

Tolerance: $\pm 12\%$

Forward Bin Limits (V_F)

Bin ID	Forward Voltage, V_F (V)	
	Min.	Max.
G03	2.8	2.9
G04	2.9	3.0
G05	3.0	3.1
G06	3.1	3.2
G07	3.2	3.3

Tolerance: $\pm 0.1V$

Color Bins (BIN)

CCT	Bin ID	Chromacity Coordinates	
		x	y
3000K	8A	0.4147	0.3814
		0.4221	0.3984
		0.4342	0.4028
		0.4259	0.3853
	8B	0.4221	0.3984
		0.4299	0.4165
		0.4430	0.4212
		0.4342	0.4028
	8C	0.4342	0.4028
		0.4430	0.4212
		0.4562	0.4260
		0.4465	0.4071
	8D	0.4259	0.3853
		0.4342	0.4028
		0.4465	0.4071
		0.4373	0.3893

CCT	Bin ID	Chromacity Coordinates	
		x	y
4000K	6A	0.3670	0.3578
		0.3702	0.3722
		0.3825	0.3798
		0.3783	0.3646
	6B	0.3702	0.3722
		0.3736	0.3874
		0.3869	0.3958
		0.3825	0.3798
	6C	0.3825	0.3798
		0.3869	0.3958
		0.4006	0.4044
		0.3950	0.3875
	6D	0.3783	0.3646
		0.3825	0.3798
		0.3950	0.3875
		0.3898	0.3716

CCT	Bin ID	Chromacity Coordinates	
		x	y
6500K	2A	0.3048	0.3207
		0.3130	0.3290
		0.3144	0.3186
		0.3068	0.3113
	2B	0.3028	0.3304
		0.3115	0.3391
		0.3130	0.3290
		0.3048	0.3207
	2C	0.3115	0.3391
		0.3205	0.3481
		0.3213	0.3373
		0.3130	0.3290
	2D	0.3130	0.3290
		0.3213	0.3373
		0.3221	0.3261
		0.3144	0.3186

Tolerance: ± 0.01

Example of bin information on reel and packaging label:

CAT: H - Flux bin H
 BIN: 8A - Color bin 8A
 VF: G05 - VF bin G05

Figure 2 Chromaticity Diagram

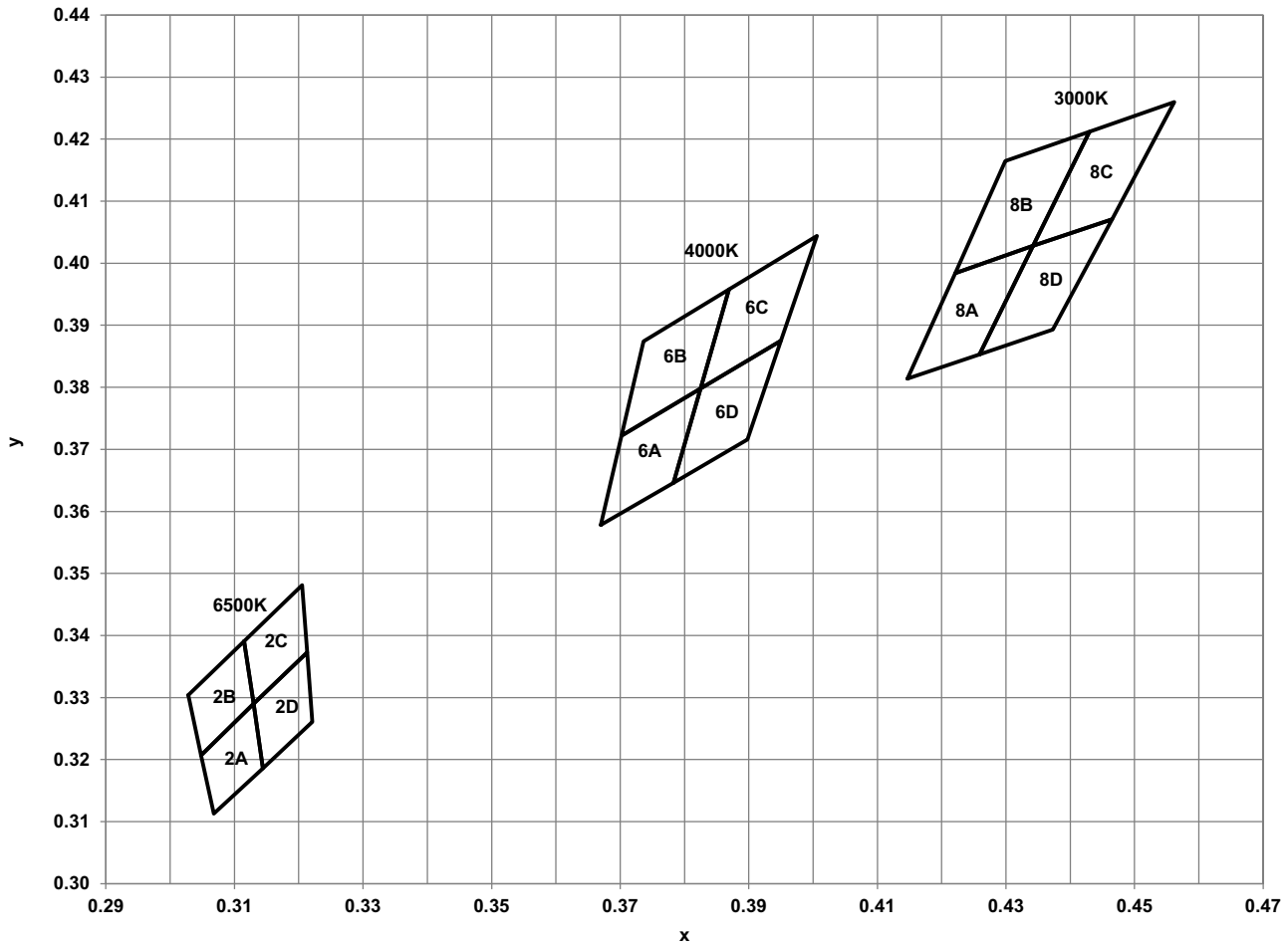

Figure 3 Spectral Power Distribution

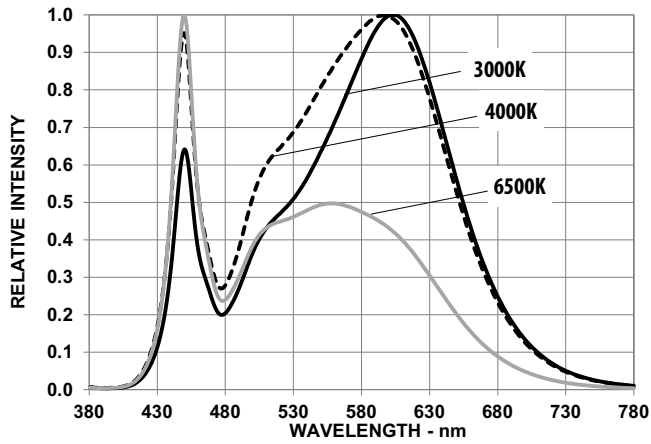

Figure 4 Forward Current vs. Forward Voltage

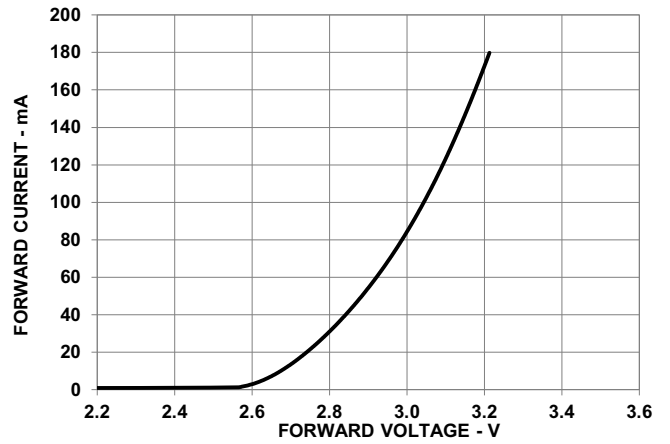

Figure 5 Relative Luminous Flux vs. Mono Pulse Current

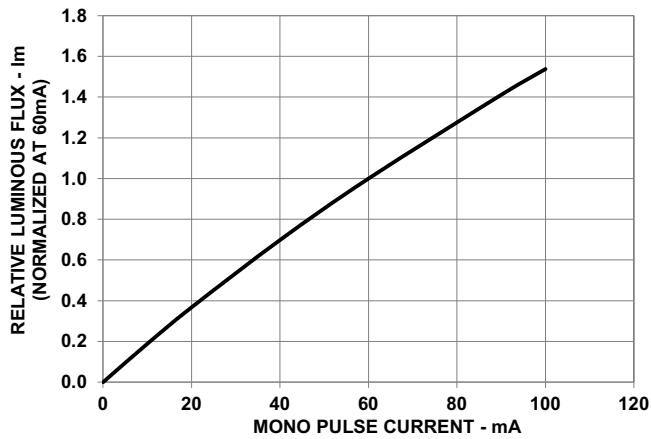

Figure 6 Radiation Pattern

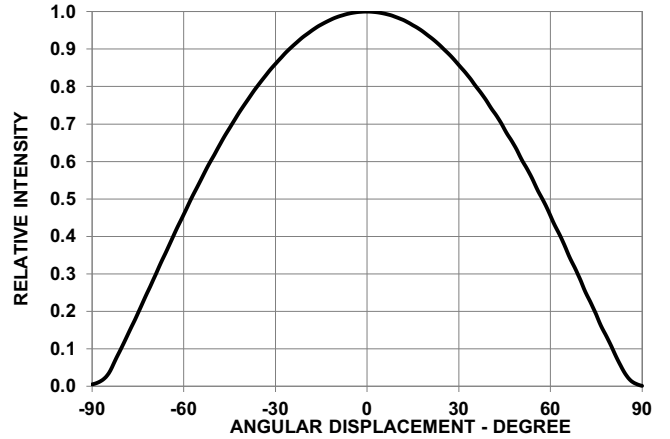

Figure 7 Chromaticity Coordinate Shift vs. Mono Pulse Current (3000K)

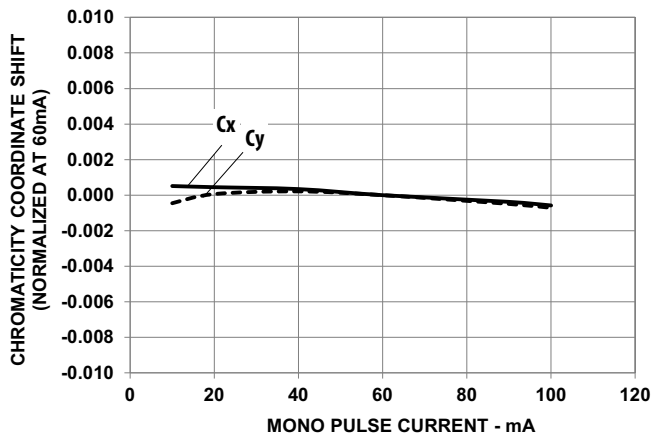

Figure 8 Chromaticity Coordinate Shift vs. Mono Pulse Current (4000K)

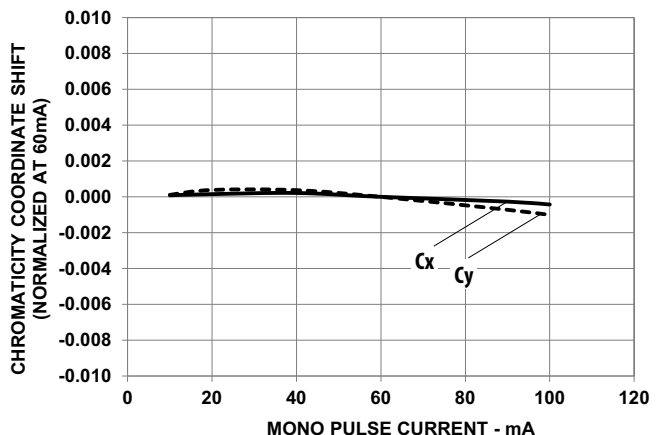

Figure 9 Chromaticity Coordinate Shift vs. Mono Pulse Current (6500K)

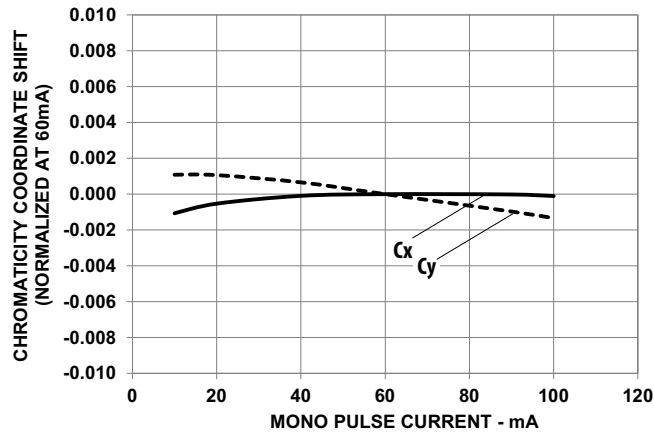

Figure 10 Relative Light Output vs. Junction Temperature

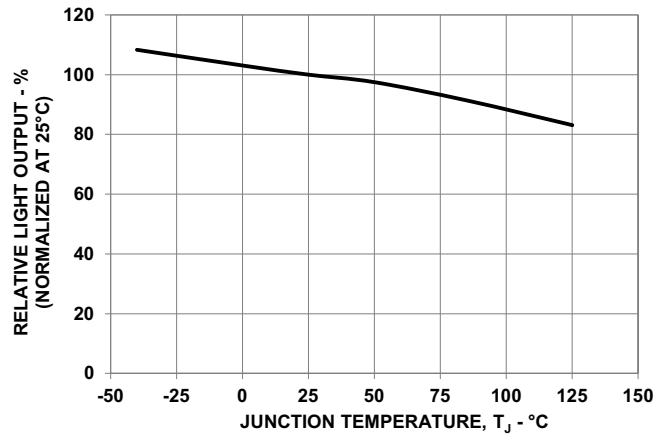

Figure 11 Forward Voltage Shift vs. Junction Temperature

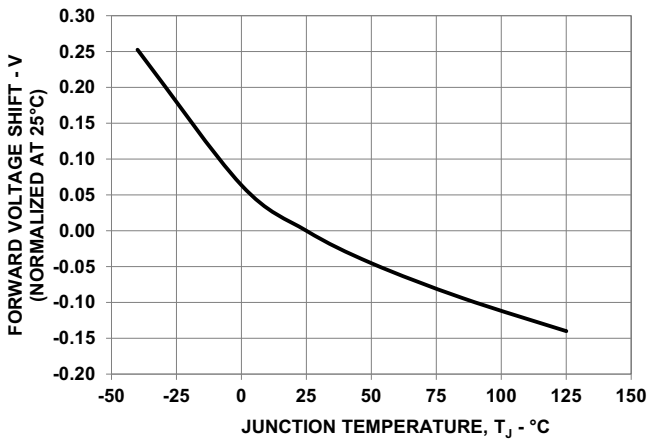

Figure 12 Chromaticity Coordinate Shift vs. Junction Temperature (3000K)

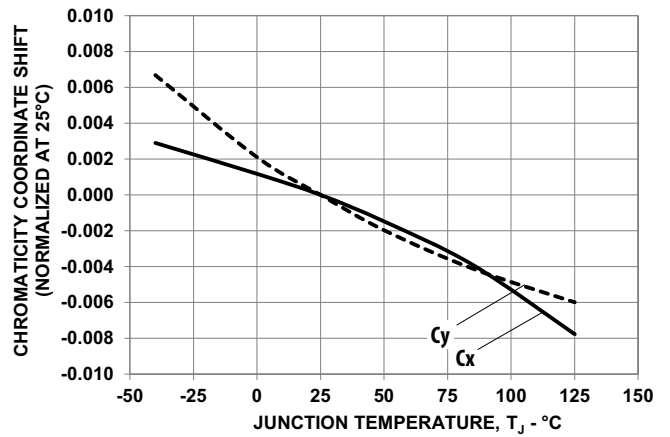

Figure 13 Chromaticity Coordinate Shift vs. Junction Temperature (4000K)

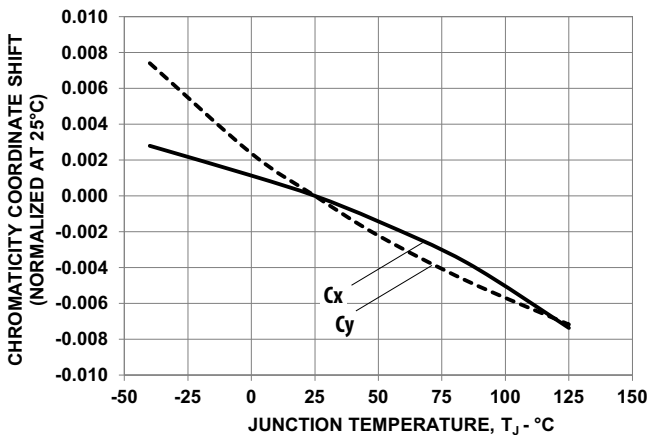

Figure 14 Chromaticity Coordinate Shift vs. Junction Temperature (6500K)

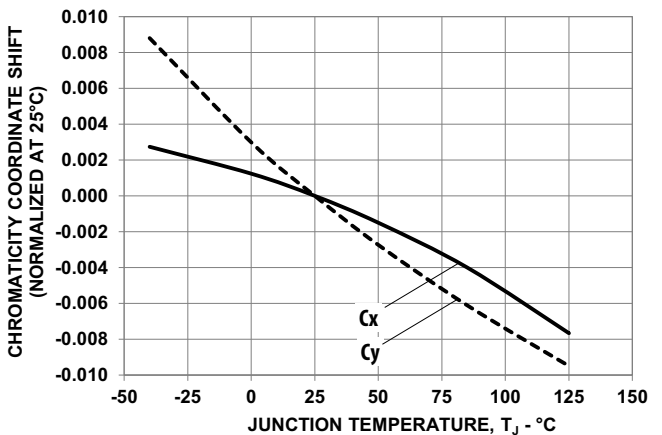

Figure 15 Maximum Forward Current vs. Ambient Temperature. Derated based on $T_{JMAX} = 125^{\circ}C$

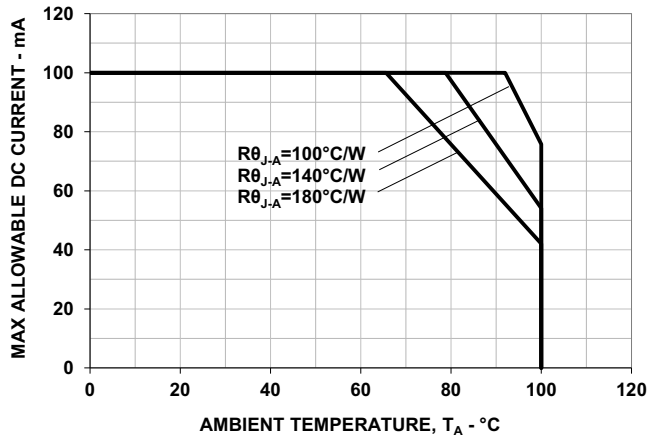

Figure 16 Maximum Forward Current vs. Solder Point Temperature. Derated based on $T_{JMAX} = 125^{\circ}C$, $R_{\theta J-S} = 40^{\circ}C/W$

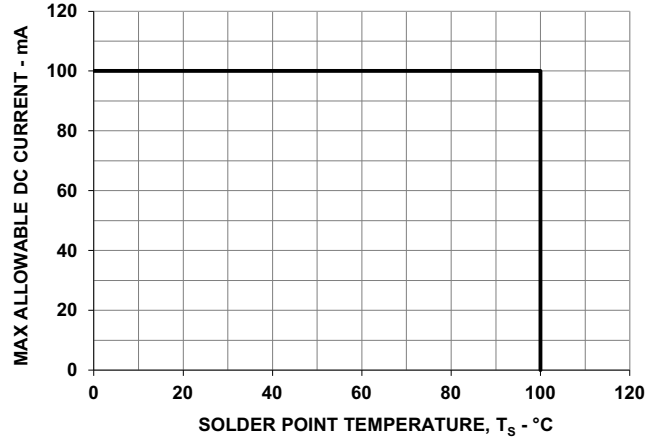

Figure 17 Pulse Handling Capability at $T_S \leq 100^{\circ}C$

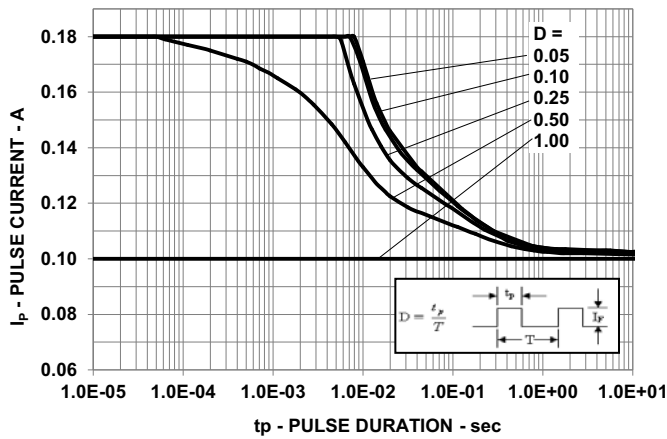
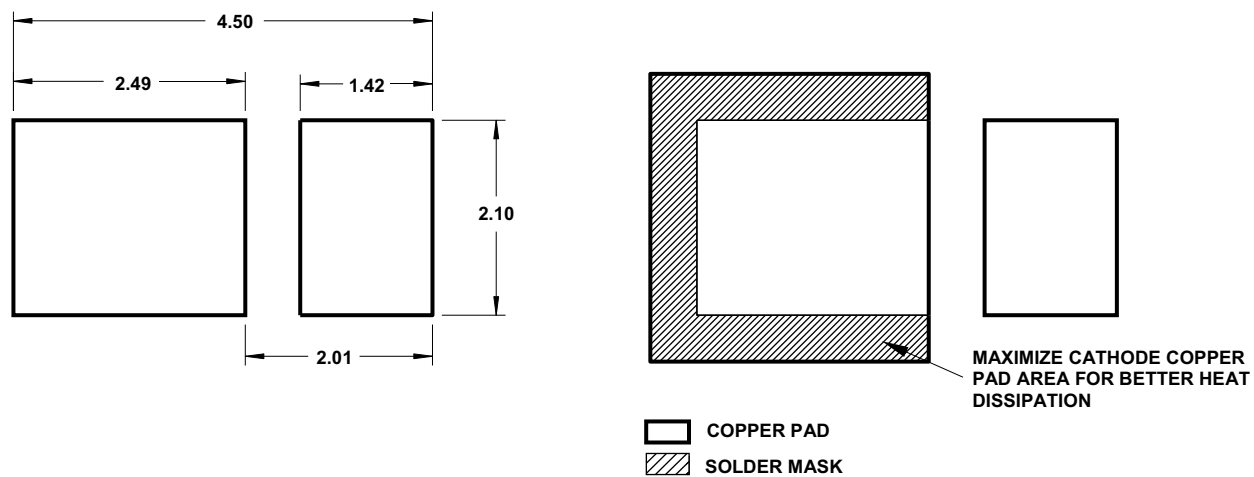
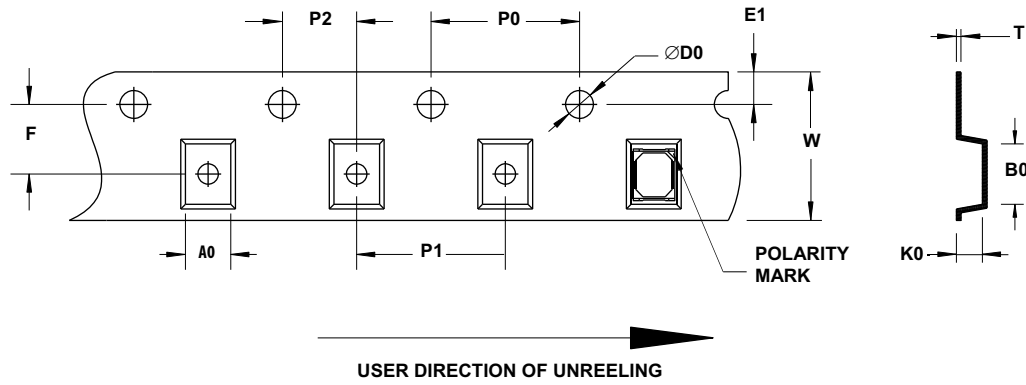

Figure 18 Recommended Soldering Land Pattern



NOTE All dimensions are in millimeters (mm).

Figure 19 Carrier Tape Dimensions



F	P0	P1	P2	D0	E1	W	T	B0	K0	A0
3.5 ± 0.05	4.0 ± 0.1	4.0 ± 0.1	2.0 ± 0.05	1.55 ± 0.05	1.75 ± 0.10	8.0 ± 0.2	0.2 ± 0.05	3.8 ± 0.1	1.05 ± 0.1	3.1 ± 0.1

NOTE All dimensions are in millimeters (mm).

Figure 20 Reel Dimension

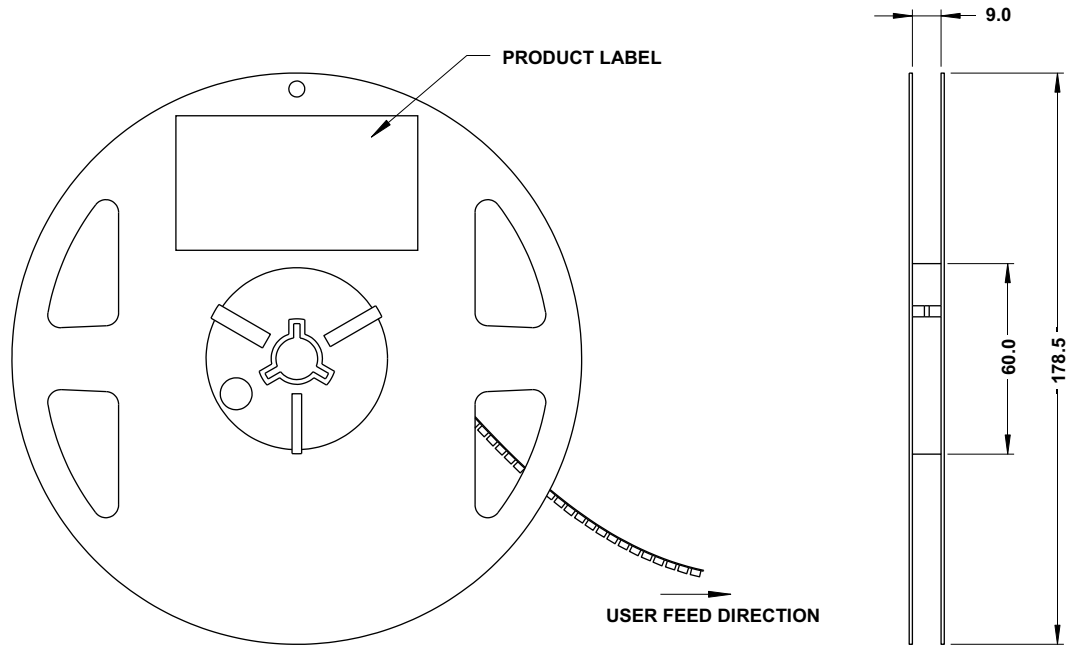

NOTE All dimensions are in millimeters (mm).

Precautionary Notes

Soldering

- Do not perform reflow soldering more than twice. Observe necessary precautions of handling moisture-sensitive device as stated in the following section.
- Do not apply any pressure or force on the LED during reflow and after reflow when the LED is still hot.
- Use reflow soldering to solder the LED. Use hand soldering only for rework if unavoidable, but it must be strictly controlled to following conditions:
 - Soldering iron tip temperature = 315°C maximum
 - Solder duration = 3 seconds maximum
 - Number of cycles = 1 only
 - Power of soldering iron = 50W maximum
- Do not touch the LED package body with the soldering iron except for the soldering terminals, as it may cause damage to the LED.
- Confirm beforehand whether the functionality and performance of the LED is affected by soldering with hand soldering.

Figure 21 Recommended Lead-Free Reflow Soldering Profile

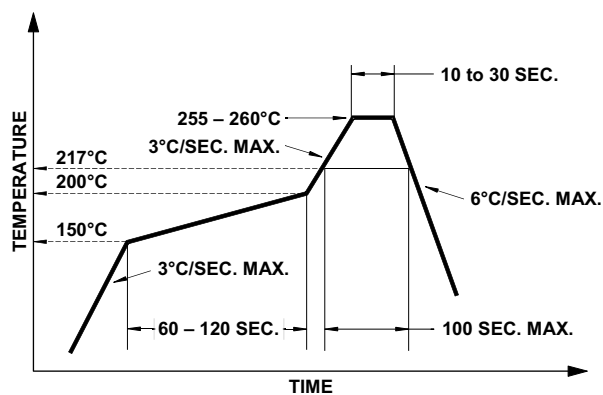
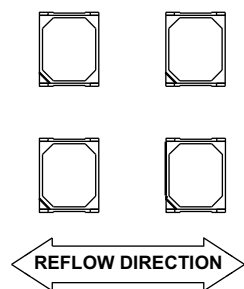

Figure 22 Recommended Board Reflow Direction



Handling Precautions

The encapsulation material of the LED is made of silicone for better product reliability. Compared to epoxy encapsulant that is hard and brittle, silicone is softer and flexible. Observe special handling precautions during assembly of silicone encapsulated LED products. Failure to comply might lead to damage and premature failure of the LED. Refer to Broadcom Application Note AN5288, *Silicone Encapsulation for LED: Advantages and Handling Precautions*, for more information.

- Do not poke sharp objects into the silicone encapsulant. Sharp objects, such as tweezers or syringes, might apply excessive force or even pierce through the silicone and induce failures to the LED die or wire bond.
- Do not touch the silicone encapsulant. Uncontrolled force acting on the silicone encapsulant might result in excessive stress on the wire bond. Hold the LED only by the body.
- Do not stack assembled PCBs together. Use an appropriate rack to hold the PCBs.
- The surface of the silicone material attracts dust and dirt easier than epoxy due to its surface tackiness. To remove foreign particles on the surface of the silicone, use a cotton bud with isopropyl alcohol (IPA). During cleaning, rub the surface gently without putting much pressure on the silicone. Ultrasonic cleaning is not recommended.
- For automated pick-and-place, Broadcom has tested a nozzle size with OD 3.5 mm to work well with this LED. However, due to the possibility of variations in other parameters, such as pick-and-place machine maker/model and other settings of the machine, verify that the selected nozzle will not damage the LED.

Handling of Moisture-Sensitive Devices

This product has a Moisture Sensitive Level 3 rating per JEDEC J-STD-020. Refer to Broadcom Application Note AN5305, *Handling of Moisture Sensitive Surface Mount Devices*, for additional details and a review of proper handling procedures.

- Before use:
 - An unopened moisture barrier bag (MBB) can be stored at < 40°C / 90% RH for 12 months. If the actual shelf life has exceeded 12 months and the humidity indicator card (HIC) indicates that baking is not required, then it is safe to reflow the LEDs per the original MSL rating.
 - Do not open the MBB prior to assembly (for example, for IQC). If unavoidable, MBB must be properly resealed with fresh desiccant and HIC. The exposed duration must be taken in as floor life.

- Control after opening the MBB:
 - Read the HIC immediately upon opening of MBB.
 - Keep the LEDs at < 30°C / 60% RH at all times, and complete all high temperature-related processes, including soldering, curing, or rework, within 168 hours.
- Control for unfinished reel:

Store unused LEDs in a sealed MBB with desiccant or desiccators at < 5% RH.
- Control of assembled boards:

If the PCB soldered with the LEDs is to be subjected to other high-temperature processes, store the PCB in a sealed MBB with desiccant or desiccators at < 5% RH to ensure that all LEDs have not exceeded their floor life of 168 hours.
- Baking is required if the following conditions exist:
 - The HIC indicator indicates a change in color for 10% and 5%, as stated on the HIC.
 - The LEDs are exposed to condition of > 30°C / 60% RH at any time.
 - The LED's floor life exceeded 168 hours.

The recommended baking condition is: 60°C ±5°C for 20 hours.

Baking should only be done once.
- Storage:

The soldering terminals of these Broadcom LEDs are silver plated. If the LEDs are exposed in ambient environment for too long, the silver plating might be oxidized, thus affecting its solderability performance. As such, keep unused LEDs in a sealed MBB with desiccant or in desiccators at < 5% RH.

Application Precautions

- The drive current of the LED must not exceed the maximum allowable limit across temperature as stated in the data sheet. Constant current driving is recommended to ensure consistent performance.
- Circuit design must cater to the whole range of forward voltage (V_F) of the LEDs to ensure the intended drive current can always be achieved.
- The LED exhibits slightly different characteristics at different drive currents, which may result in a larger variation of performance (meaning intensity, wavelength, and forward voltage). Set the application current as close as possible to the test current to minimize these variations.
- Do not use the LED in the vicinity of material with sulfur content or in environments of high gaseous sulfur compounds and corrosive elements. Examples of materials that might contain sulfur are rubber gaskets,

room-temperature vulcanizing (RTV) silicone rubber, rubber gloves, and so on. Prolonged exposure to such environments may affect the optical characteristics and product life.

- White LEDs must not be exposed to acidic environment and must not be used in the vicinity of compounds that may have acidic outgas, such as, but not limited to, acrylate adhesive. These environments have an adverse effect on LED performance.
- Avoid rapid change in ambient temperature, especially in high-humidity environments, because they cause condensation on the LED.
- If the LED is intended to be used in harsh or outdoor environment, protect the LED against damages caused by rain water, water, dust, oil, corrosive gases, external mechanical stress, and so on.

Thermal Management

The optical, electrical and reliability characteristics of LED are affected by temperature. Keep the junction temperature (T_J) of the LED below the allowable limit at all times. T_J can be calculated as follows:

$$T_J = T_A + R_{\theta J-A} \times I_F \times V_{Fmax}$$

- where
- T_A = Ambient temperature (°C)
 - $R_{\theta J-A}$ = Thermal resistance from the LED junction to ambient (°C/W)
 - I_F = Forward current (A)
 - V_{Fmax} = Maximum forward voltage (V)

The complication of using this formula lies in T_A and $R_{\theta J-A}$. Actual T_A is sometimes subjective and hard to determine. $R_{\theta J-A}$ varies from system to system depending on design and is usually not known.

Another way of calculating T_J is by using the solder point temperature, T_S as follows:

$$T_J = T_S + R_{\theta J-S} \times I_F \times V_{Fmax}$$

- where
- T_S = LED solder point temperature as shown in [Figure 23](#) (°C)
 - $R_{\theta J-S}$ = Thermal resistance from the junction to the solder point (°C/W)
 - I_F = Forward current (A)
 - V_{Fmax} = Maximum forward voltage (V)

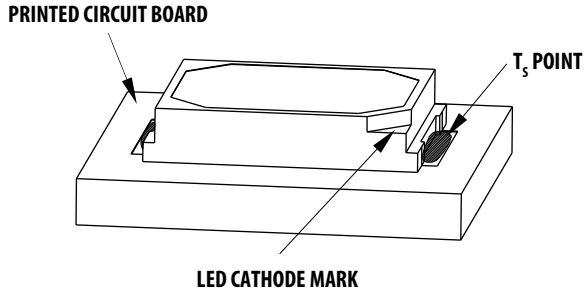
Figure 23 Solder Point Temperature on PCB

T_s can be easily measured by mounting a thermocouple on the soldering joint as shown in [Figure 23](#). Verify the T_s of the LED in the final product to ensure that the LEDs are operated within all maximum ratings stated in the data sheet.

Eye Safety and Precautions

LEDs may pose optical hazards when in operation. Do not look directly at operating LEDs because it might be harmful to the eyes. For safety reasons, use appropriate shielding or personal protective equipment.

Disclaimer

Broadcom's products are not specifically designed, manufactured, or authorized for sale as parts, components, or assemblies for the planning, construction, maintenance, or direct operation of a nuclear facility or for use in medical devices or applications. The customer is solely responsible, and waives all rights to make claims against Broadcom or its suppliers, for all loss, damage, expense, or liability in connection with such use.

For product information and a complete list of distributors, please go to our web site: www.broadcom.com.

Broadcom, the pulse logo, Connecting everything, Avago Technologies, Avago, and the A logo are among the trademarks of Broadcom and/or its affiliates in the United States, certain other countries and/or the EU.

Copyright © 2017 by Broadcom. All Rights Reserved.

The term "Broadcom" refers to Broadcom Limited and/or its subsidiaries. For more information, please visit www.broadcom.com.

Broadcom reserves the right to make changes without further notice to any products or data herein to improve reliability, function, or design.

Information furnished by Broadcom is believed to be accurate and reliable. However, Broadcom does not assume any liability arising out of the application or use of this information, nor the application or use of any product or circuit described herein, neither does it convey any license under its patent rights nor the rights of others.

ASMW-FWG0-Nxxx6-DS101 – October 13, 2017



Данный компонент на территории Российской Федерации

Вы можете приобрести в компании MosChip.

Для оперативного оформления запроса Вам необходимо перейти по данной ссылке:

<http://moschip.ru/get-element>

Вы можете разместить у нас заказ для любого Вашего проекта, будь то серийное производство или разработка единичного прибора.

В нашем ассортименте представлены ведущие мировые производители активных и пассивных электронных компонентов.

Нашей специализацией является поставка электронной компонентной базы двойного назначения, продукции таких производителей как XILINX, Intel (ex.ALTERA), Vicor, Microchip, Texas Instruments, Analog Devices, Mini-Circuits, Amphenol, Glenair.

Сотрудничество с глобальными дистрибьюторами электронных компонентов, предоставляет возможность заказывать и получать с международных складов практически любой перечень компонентов в оптимальные для Вас сроки.

На всех этапах разработки и производства наши партнеры могут получить квалифицированную поддержку опытных инженеров.

Система менеджмента качества компании отвечает требованиям в соответствии с ГОСТ Р ИСО 9001, ГОСТ РВ 0015-002 и ЭС РД 009

Офис по работе с юридическими лицами:

105318, г.Москва, ул.Щербаковская д.3, офис 1107, 1118, ДЦ «Щербаковский»

Телефон: +7 495 668-12-70 (многоканальный)

Факс: +7 495 668-12-70 (доб.304)

E-mail: info@moschip.ru

Skype отдела продаж:

moschip.ru

moschip.ru_4

moschip.ru_6

moschip.ru_9