

HLMP-3351, HLMP-3366, HLMP-3451, HLMP-3466, HLMP-3554, HLMP-3568

T-1³/₄ (5 mm) Low Profile LED Lamps



Data Sheet



Description

The HLMP-335x/-336x Series are Gallium Arsenide Phosphide on Gallium Phosphide High Efficiency Red Light Emitting Diodes.

The HLMP-345x/-346x Series are Gallium Arsenide Phosphide on Gallium Phosphide Yellow Light Emitting Diodes.

The HLMP-355x/-356x Series are Gallium Phosphide Green Light Emitting Diodes.

The Low Profile T-1³/₄ package provides space savings and is excellent for backlighting applications.

Features

- High intensity
- Low profile: 5.8 mm (0.23 in.) nominal
- T-1³/₄ diameter package
- Diffused and non-diffused types
- General purpose leads
- IC compatible/low current requirements
- Reliable and rugged

Package Dimensions

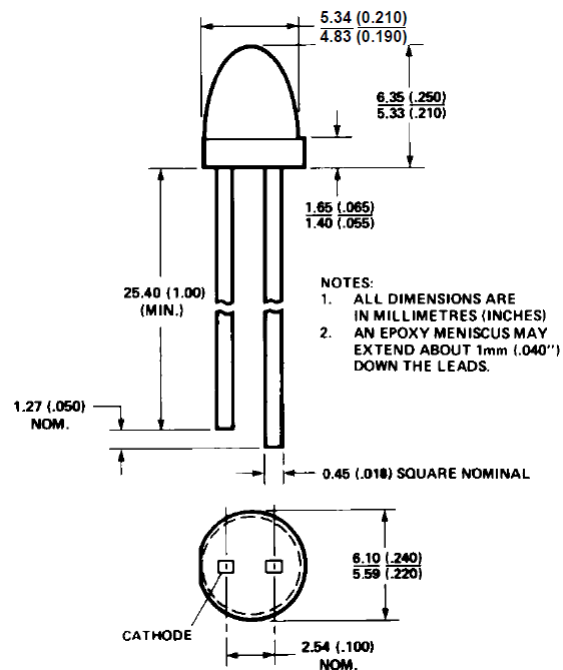

Selection Guide

| Color | Package Description | 2θ ^{1/2} [1] | Part Number HLMP- | Luminous Intensity I _v (mcd) | |
|--------|---|-----------------------|----------------------|---|------|
| | | | | Min. | Max. |
| Red | T-1 ^{3/4} Tinted, diffused | 50 | 3351 | 5.4 | - |
| | | | 3351-D00xx | 2.1 | - |
| | | | 3351-F00xx | 5.4 | - |
| | T-1 ^{3/4} Tinted, non-diffused | 45 | 3366 | 13.8 | - |
| | | | 3366-H00xx | 13.8 | - |
| | | | | | |
| Yellow | T-1 ^{3/4} Tinted, diffused | 50 | 3451 | 3.6 | - |
| | | | 3451-D00xx | 3.6 | - |
| | | | 3451-EFBxx | 5.7 | 18.4 |
| | | | 3451-F00xx | 9.2 | - |
| | T-1 ^{3/4} Tinted, non-diffused | 45 | 3466 | 9.2 | - |
| | | | 3466-F00xx | 9.2 | - |
| Green | T-1 ^{3/4} Tinted, diffused | 50 | 3554 | 6.7 | - |
| | | | 3554-E00xx | 6.7 | - |
| | T-1 ^{3/4} Tinted, non-diffused | 40 | 3568 | 10.6 | - |
| | | | 3568-F00xx | 10.6 | - |

Part Numbering System

HLMP - 3 x xx - x x x xx

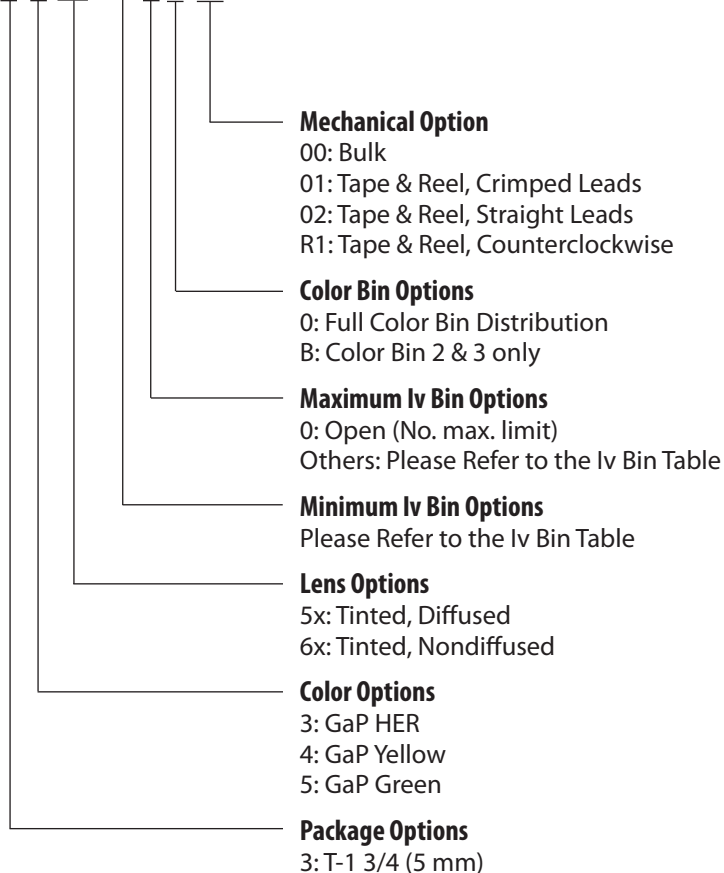

Absolute Maximum Ratings at $T_A = 25^\circ\text{C}$

| Parameter | 3350 Series | 3450 Series | 3550 Series | Units |
|---|------------------------------------|-------------|-------------|------------------|
| Peak Forward Current | 90 | 60 | 90 | mA |
| Average Forward Current ^[1] | 25 | 20 | 25 | mA |
| DC Current ^[2] | 30 | 20 | 30 | mA |
| Power Dissipation ^[3] | 135 | 85 | 135 | mW |
| Reverse Voltage ($I_R = 100 \mu\text{A}$) | 5 | 5 | 5 | V |
| Transient Forward Current ^[4] (10 μs Pulse) | 500 | 500 | 500 | mA |
| Operating Temperature Range | -40 to +100 | -40 to +100 | -20 to +100 | $^\circ\text{C}$ |
| Storage Temperature Range | -40 to +100 | -40 to +100 | -40 to +100 | |
| Wave Soldering Temperature [1.59 mm (0.063 in.) from Body] | 250 $^\circ\text{C}$ for 3 seconds | | | |
| Solder Dipping Temperature [1.59 mm (0.063 in.) from Body] | 260 $^\circ\text{C}$ for 5 seconds | | | |

Notes:

- See Figure 10 (High Efficiency Red), 15 (Yellow), or 20 (Green) to establish pulsed operating conditions.
- For High Efficiency Red and Green Series, derate linearly from 50 $^\circ\text{C}$ at 0.5 mA/ $^\circ\text{C}$. For Red and Yellow Series, derate linearly from 50 $^\circ\text{C}$ at 0.2 mA/ $^\circ\text{C}$.
- For High Efficiency Red and Green Series, derate power linearly from 25 $^\circ\text{C}$ at 1.8 mW/ $^\circ\text{C}$. For Red and Yellow Series, derate power linearly from 50 $^\circ\text{C}$ at 1.6 mW/ $^\circ\text{C}$.
- The transient peak current is the maximum non-recurring peak current that can be applied to the device without damaging the LED die and wirebond. It is not recommended that the device be operated at peak current beyond the peak forward current listed in the Absolute Maximum Ratings.



Figure 1. Relative intensity vs. wavelength.

High Efficiency Red HLMP-335x/-336x Series Electrical Specifications at $T_A = 25^\circ\text{C}$

| Symbol | Description | Device HLMP- | Min. | Typ. | Max. | Units | Test Conditions |
|--------------------------|--|-----------------|------|----------------------|------|--------------------|--------------------------------|
| $2\theta_{1/2}$ | Including Angle Between Half Luminous Intensity Points | 3366 | | 50 50 45 45 | | Deg. | Note 1 (Figure 11) |
| λ_{PEAK} | Peak Wavelength | | | 635 | | nm | Measurement at Peak (Figure 1) |
| λ_d | Dominant Wavelength | | | 626 | | nm | Note 2 |
| $\Delta\lambda_{1/2}$ | Spectral Line Halfwidth | | | 40 | | nm | |
| τ_s | Speed of Response | | | 90 | | ns | |
| C | Capacitance | | | 11 | | pF | $V_F = 0$; $f = 1$ MHz |
| $R\theta_{\text{J-PIN}}$ | Thermal Resistance | | | 260 | | $^\circ\text{C/W}$ | Junction to Cathode Lead |
| V_F | Forward Voltage | | | 1.9 | 2.4 | V | $I_F = 10$ mA (Figure 7) |
| V_R | Reverse Breakdown Voltage | | 5.0 | | | V | $I_R = 100$ μA |
| η_V | Luminous Efficacy | | | 145 | | lm/W | Note 3 |

Notes:

- $\theta_{1/2}$ is the off-axis angle at which the luminous intensity is half the axial luminous intensity.
- Dominant wavelength, λ_d , is derived from the CIE chromaticity diagram and represents the single wavelength which defines the color of the device.
- Radiant Intensity, I_e , in watts/steradian may be found from the equation $I_e = I_v/\eta_v$, where I_v is the luminous intensity in candelas and η_v is the luminous efficacy in lumens/watt.



Figure 7. Forward current vs. forward voltage.

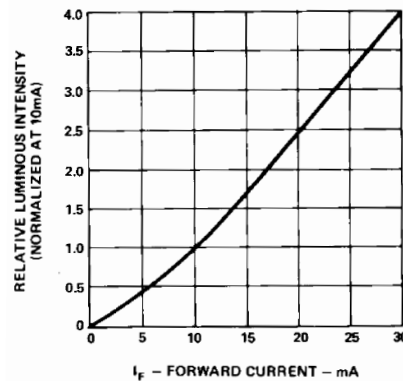

Figure 8. Relative luminous intensity vs. forward current.



Figure 9. Relative efficiency (luminous intensity per unit current) vs. peak current.



Figure 10. Maximum tolerable peak current vs. pulse duration. (I_{DC} MAX as per MAX ratings).



Figure 11. Relative luminous intensity vs. angular displacement.

Yellow HLMP-345x/-346x Series Electrical Specifications at $T_A = 25^\circ\text{C}$

| Symbol | Description | Device HLMP- | Min. | Typ. | Max. | Units | Test Conditions |
|-----------------------|--|-----------------|------|----------------------|------|---------------------------|--------------------------------|
| $2\theta_{1/2}$ | Including Angle Between Half Luminous Intensity Points | 3466 | | 50 50 45 45 | | Deg. | Note 1 (Figure 16) |
| λ_{PEAK} | Peak Wavelength | | | 583 | | nm | Measurement at Peak (Figure 1) |
| λ_d | Dominant Wavelength | | | 585 | | nm | Note 2 |
| $\Delta\lambda_{1/2}$ | Spectral Line Halfwidth | | | 36 | | nm | |
| τ_s | Speed of Response | | | 90 | | ns | |
| C | Capacitance | | | 15 | | pF | $V_F = 0$; $f = 1$ MHz |
| $R\theta_{J-PIN}$ | Thermal Resistance | | | 260 | | $^\circ\text{C}/\text{W}$ | Junction to Cathode Lead |
| V_F | Forward Voltage | | | 2.0 | 2.4 | V | $I_F = 10$ mA (Figure 12) |
| V_R | Reverse Breakdown Voltage | | 5.0 | | | V | $I_R = 100$ μA |
| η_V | Luminous Efficacy | | | 500 | | lm/W | Note 3 |

Notes:

- $\theta_{1/2}$ is the off-axis angle at which the luminous intensity is half the axial luminous intensity.
- Dominant wavelength, λ_d , is derived from the CIE chromaticity diagram and represents the single wavelength which defines the color of the device.
- Radiant Intensity, I_e , in watts/steradian may be found from the equation $I_e = I_v/\eta_v$, where I_v is the luminous intensity in candelas and η_v is the luminous efficacy in lumens/watt.



Figure 12. Forward current vs. forward voltage.



Figure 13. Relative luminous intensity vs. forward current.



Figure 14. Relative efficiency (luminous intensity per unit current) vs. peak current.



Figure 15. Maximum tolerable peak current vs. pulse duration. (I_{DC} MAX as per MAX ratings).

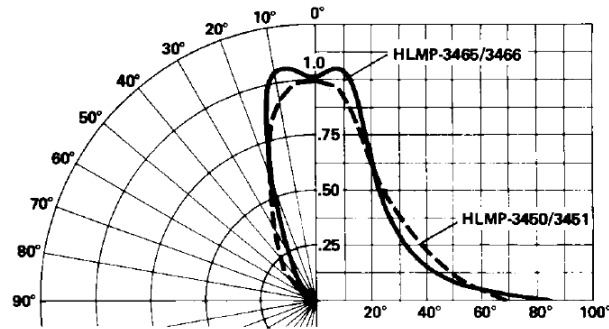

Figure 16. Relative luminous intensity vs. angular displacement.

Green HLMP-355x/-356x Series
Electrical Specifications at $T_A = 25^\circ\text{C}$

| Symbol | Description | Device HLMP- | Min. | Typ. | Max. | Units | Test Conditions |
|--------------------------|--|-----------------|------|----------|------|--------------------|--------------------------------|
| $2\theta_{1/2}$ | Including Angle Between Half Luminous Intensity Points | 3554 3568 | | 50 40 | | Deg. | Note 1 (Figure 21) |
| λ_{PEAK} | Peak Wavelength | | | 565 | | nm | Measurement at Peak (Figure 1) |
| λ_d | Dominant Wavelength | | | 569 | | nm | Note 2 |
| $\Delta\lambda_{1/2}$ | Spectral Line Halfwidth | | | 28 | | nm | |
| τ_s | Speed of Response | | | 500 | | ns | |
| C | Capacitance | | | 18 | | pF | $V_F = 0$; $f = 1$ MHz |
| $R\theta_{\text{J-PIN}}$ | Thermal Resistance | | | 260 | | $^\circ\text{C/W}$ | Junction to Cathode Lead |
| V_F | Forward Voltage | | | 2.1 | 2.7 | V | $I_F = 10$ mA (Figure 17) |
| V_R | Reverse Breakdown Voltage | | 5.0 | | | V | $I_R = 100$ μA |
| η_V | Luminous Efficacy | | | 595 | | lm/W | Note 3 |

Notes:

- $\theta_{1/2}$ is the off-axis angle at which the luminous intensity is half the axial luminous intensity.
- Dominant wavelength, λ_d , is derived from the CIE chromaticity diagram and represents the single wavelength which defines the color of the device.
- Radiant Intensity, I_e , in watts/steradian may be found from the equation $I_e = I_v/\eta_v$, where I_v is the luminous intensity in candelas and η_v is the luminous efficacy in lumens/watt.

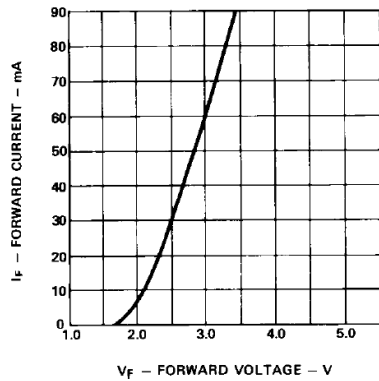

Figure 17. Forward current vs. forward voltage.

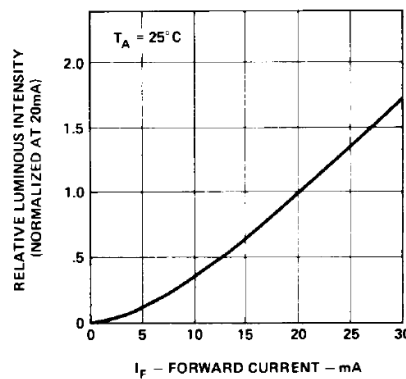

Figure 18. Relative luminous intensity vs. forward current.

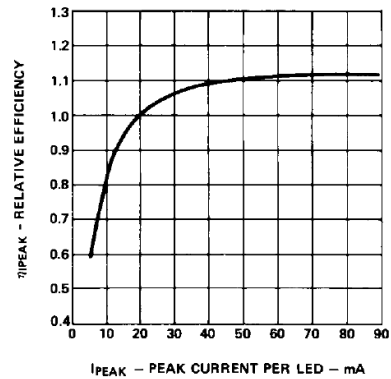

Figure 19. Relative efficiency (luminous intensity per unit current) vs. peak current.



Figure 20. Maximum tolerable peak current vs. pulse duration. (I_{DC} MAX as per MAX ratings).



Figure 21. Relative luminous intensity vs. angular displacement.

Intensity Bin Limits

| Color | Bin | Intensity Range (mcd) | |
|-------|---------|-----------------------|---------|
| | | Min. | Max. |
| Red | D | 2.4 | 3.8 |
| | E | 3.8 | 6.1 |
| | F | 6.1 | 9.7 |
| | G | 9.7 | 15.5 |
| | H | 15.5 | 24.8 |
| | I | 24.8 | 39.6 |
| | J | 39.6 | 63.4 |
| | K | 63.4 | 101.5 |
| | L | 101.5 | 162.4 |
| | M | 162.4 | 234.6 |
| | N | 234.6 | 340.0 |
| | O | 340.0 | 540.0 |
| | P | 540.0 | 850.0 |
| | Q | 850.0 | 1200.0 |
| | R | 1200.0 | 1700.0 |
| | S | 1700.0 | 2400.0 |
| | T | 2400.0 | 3400.0 |
| | U | 3400.0 | 4900.0 |
| | V | 4900.0 | 7100.0 |
| | W | 7100.0 | 10200.0 |
| X | 10200.0 | 14800.0 | |
| Y | 14800.0 | 21400.0 | |
| Z | 21400.0 | 30900.0 | |

| Color | Bin | Intensity Range (mcd) | |
|--------|---------|-----------------------|--------|
| | | Min. | Max. |
| Yellow | D | 4.0 | 6.5 |
| | E | 6.5 | 10.3 |
| | F | 10.3 | 16.6 |
| | G | 16.6 | 26.5 |
| | H | 26.5 | 42.3 |
| | I | 42.3 | 67.7 |
| | J | 67.7 | 108.2 |
| | K | 108.2 | 173.2 |
| | L | 173.2 | 250.0 |
| | M | 250.0 | 360.0 |
| | N | 360.0 | 510.0 |
| | O | 510.0 | 800.0 |
| | P | 800.0 | 1250.0 |
| Q | 1250.0 | 1800.0 | |
| R | 1800.0 | 2900.0 | |
| S | 2900.0 | 4700.0 | |
| T | 4700.0 | 7200.0 | |
| U | 7200.0 | 11700.0 | |
| V | 11700.0 | 18000.0 | |
| W | 18000.0 | 27000.0 | |

Maximum tolerance for each bin limit is $\pm 18\%$.

Intensity Bin Limits, continued

| Color | Bin | Intensity Range (mcd) | |
|-------|---------|-----------------------|---------|
| | | Min. | Max. |
| Green | E | 7.6 | 12.0 |
| | F | 12.0 | 19.1 |
| | G | 19.1 | 30.7 |
| | H | 30.7 | 49.1 |
| | I | 49.1 | 78.5 |
| | J | 78.5 | 125.7 |
| | K | 125.7 | 201.1 |
| | L | 201.1 | 289.0 |
| | M | 289.0 | 417.0 |
| | N | 417.0 | 680.0 |
| | O | 680.0 | 1100.0 |
| | P | 1100.0 | 1800.0 |
| | Q | 1800.0 | 2700.0 |
| | R | 2700.0 | 4300.0 |
| | S | 4300.0 | 6800.0 |
| | T | 6800.0 | 10800.0 |
| | U | 10800.0 | 16000.0 |
| V | 16000.0 | 25000.0 | |
| W | 25000.0 | 40000.0 | |

Maximum tolerance for each bin limit is $\pm 18\%$.

Color Categories

| Color | Cat# | Lambda (nm) | |
|-------|--------|-------------|-------|
| | | Min. | Max. |
| Green | 6 | 561.5 | 564.5 |
| | 5 | 564.5 | 567.5 |
| | 4 | 567.5 | 570.5 |
| | 3 | 570.5 | 573.5 |
| | 2 | 573.5 | 576.5 |
| | Yellow | 1 | 582.0 |
| 3 | | 584.5 | 587.0 |
| 2 | | 587.0 | 589.5 |
| 4 | | 589.5 | 592.0 |
| 5 | | 592.0 | 593.0 |

Maximum tolerance for each bin limit is ± 0.5 nm.

Mechanical Option Matrix

| Mechanical Option Code | Definition |
|------------------------|---|
| 00 | Bulk Packaging, minimum increment 500 pcs/bag |
| 01 | Tape & Reel, crimped leads, minimum increment 1300 pcs/bag |
| 02 | Tape & Reel, straight leads, minimum increment 1300 pcs/bag |
| R1 | Tape & Reel, crimped leads, reeled counterclockwise, anode leaves first |

Note:

All categories are established for classification of products. Products may not be available in all categories. Please contact your local Avago representative for further clarification/information.

For product information and a complete list of distributors, please go to our web site: www.avagotech.com

Данный компонент на территории Российской Федерации

Вы можете приобрести в компании MosChip.

Для оперативного оформления запроса Вам необходимо перейти по данной ссылке:

<http://moschip.ru/get-element>

Вы можете разместить у нас заказ для любого Вашего проекта, будь то серийное производство или разработка единичного прибора.

В нашем ассортименте представлены ведущие мировые производители активных и пассивных электронных компонентов.

Нашей специализацией является поставка электронной компонентной базы двойного назначения, продукции таких производителей как XILINX, Intel (ex.ALTERA), Vicor, Microchip, Texas Instruments, Analog Devices, Mini-Circuits, Amphenol, Glenair.

Сотрудничество с глобальными дистрибьюторами электронных компонентов, предоставляет возможность заказывать и получать с международных складов практически любой перечень компонентов в оптимальные для Вас сроки.

На всех этапах разработки и производства наши партнеры могут получить квалифицированную поддержку опытных инженеров.

Система менеджмента качества компании отвечает требованиям в соответствии с ГОСТ Р ИСО 9001, ГОСТ РВ 0015-002 и ЭС РД 009

Офис по работе с юридическими лицами:

105318, г.Москва, ул.Щербаковская д.3, офис 1107, 1118, ДЦ «Щербаковский»

Телефон: +7 495 668-12-70 (многоканальный)

Факс: +7 495 668-12-70 (доб.304)

E-mail: info@moschip.ru

Skype отдела продаж:

moschip.ru

moschip.ru_4

moschip.ru_6

moschip.ru_9