

XBP14E5UFN-G

ETR29021-001

Low Capacitance TVS Diode Array

FEATURES

Terminal Capacitance	: 0.8pF (Line-to-GND)
ESD Protection	: 8kV Contact (IEC61000-4-2)
Environmentally Friendly	: EU RoHS Compliant, Pb Free

APPLICATIONS

- USB 3.0
- DVI
- Set Top Box

PRODUCT NAME

PRODUCT NAME	PACKAGE	ORDER UNIT
XBP14E5UFN-G *	DFN2510-10A	5,000pcs/Reel

* The "-G" suffix denotes Halogen and Antimony free as well as being fully EU RoHS compliant.

PIN CONFIGURATION

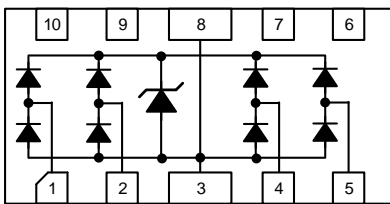

1. I/O 1
2. I/O 2
3. GND
4. I/O 3
5. I/O 4
6. NC
7. NC
8. GND
9. NC
10. NC

PACKAGING INFORMATION

● DFN2510-10A

Unit : inch (mm)

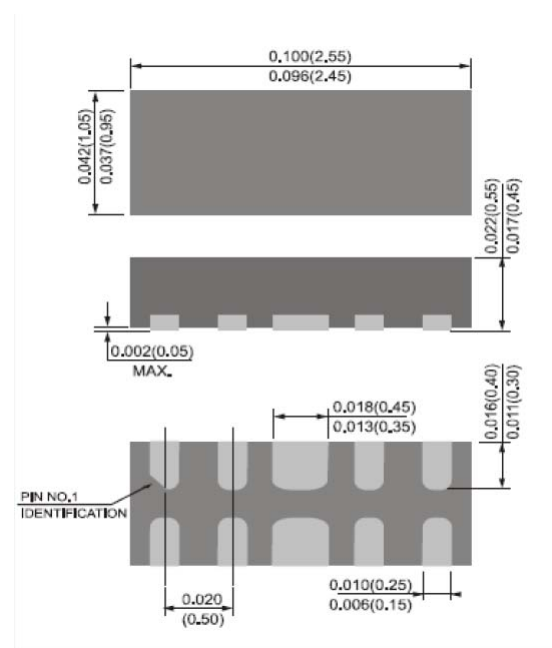

ABSOLUTE MAXIMUM RATINGS

Ta=25°C

PARAMETER	SYMBOL	RATINGS	UNIT
Junction Temperature	T _j	125	°C
Storage Temperature	T _{stg}	-55 to +150	°C
IEC61000-4-2 (ESD) Air	V _{ESD_A}	±15	kV
IEC61000-4-2 (ESD) Contact	V _{ESD_C}	±8	kV

ELECTRICAL CHARACTERISTICS

Ta=25°C

PARAMETER	SYMBOL	TEST CONDITIONS	LIMITS			UNIT
			MIN.	TYP.	MAX.	
Stand-Off Voltage	V _{RWM}		-	-	5	V
Breakdown Voltage	V _{BR}	I _R =1mA, I/O pin to Pin3	6	-	9	V
Leakage Current	I _R	V _R =5V, I/O pin to Pin3	-	-	1	μA
Clamping Voltage (8/20 μs)	V _C	I _{PP} =2.5A, I/O pin to Pin3	-	11	13	V
Terminal Capacitance	C _t	V _R =0V, f=1MHz Between I/O pin to Pin3	-	0.6	0.8	pF
	C _t	V _R =0V, f=1MHz Between I/O pins	-	0.35	0.4	pF

NOTES ON USE

1. Please use this IC within the absolute maximum ratings.

Even within the ratings, in case of high load use continuously such as high temperature, high voltage, high current and thermal stress may cause reliability degradation of the IC.

2. Torex places an importance on improving our products and their reliability.

We request that users incorporate fail-safe designs and post-aging protection treatment when using Torex products in their systems.

TYPICAL PERFORMANCE CHARACTERISTICS

(1) Clamping Voltage vs. Peak Pulse Current

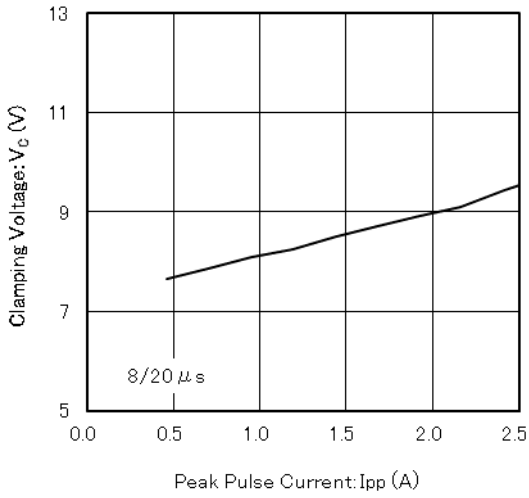

(2) Reverse Current vs. Reverse Voltage

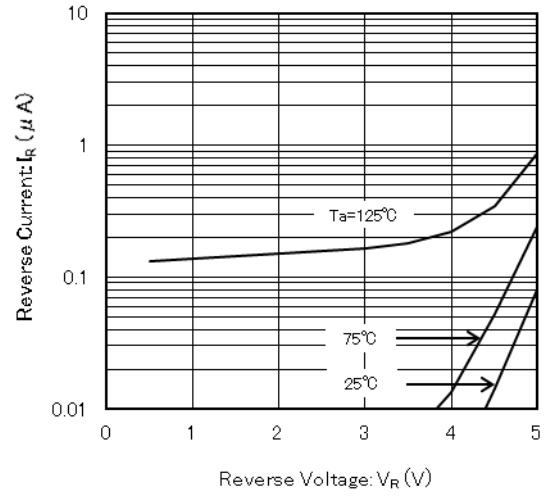

(3) Transmission Line Pulse (TLP) Measurement

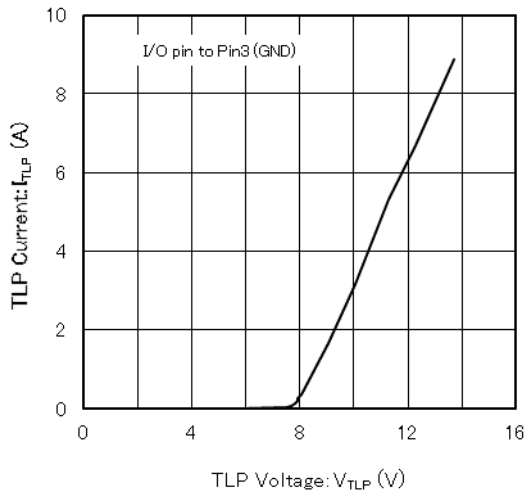

XBP14E5UFN-G

REFERENCE PATTERN LAYOUT

●DFN2510-10A

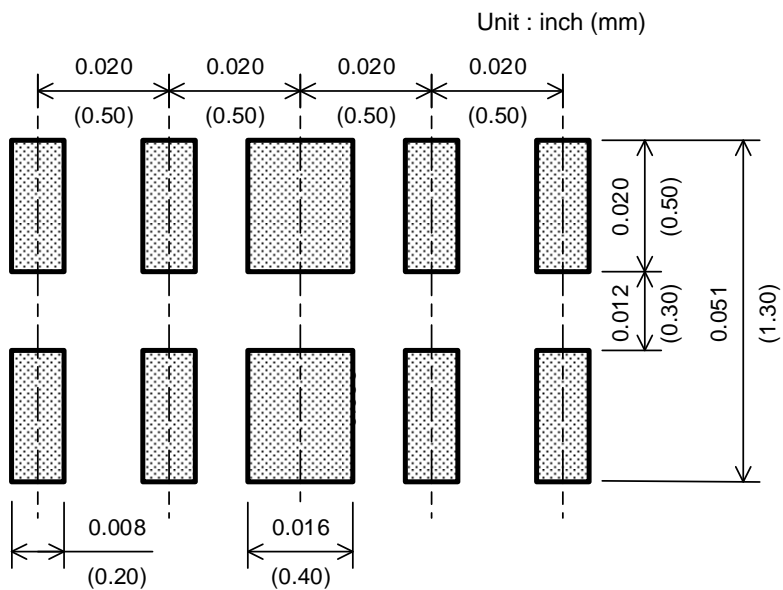

MARKING

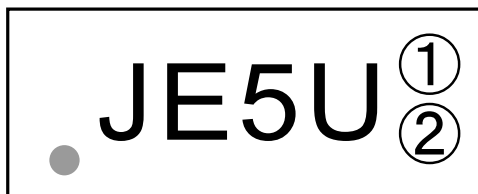

①② : Control Number

TAPING SPECIFICATIONS

●DFN2510-10A

Unit : mm

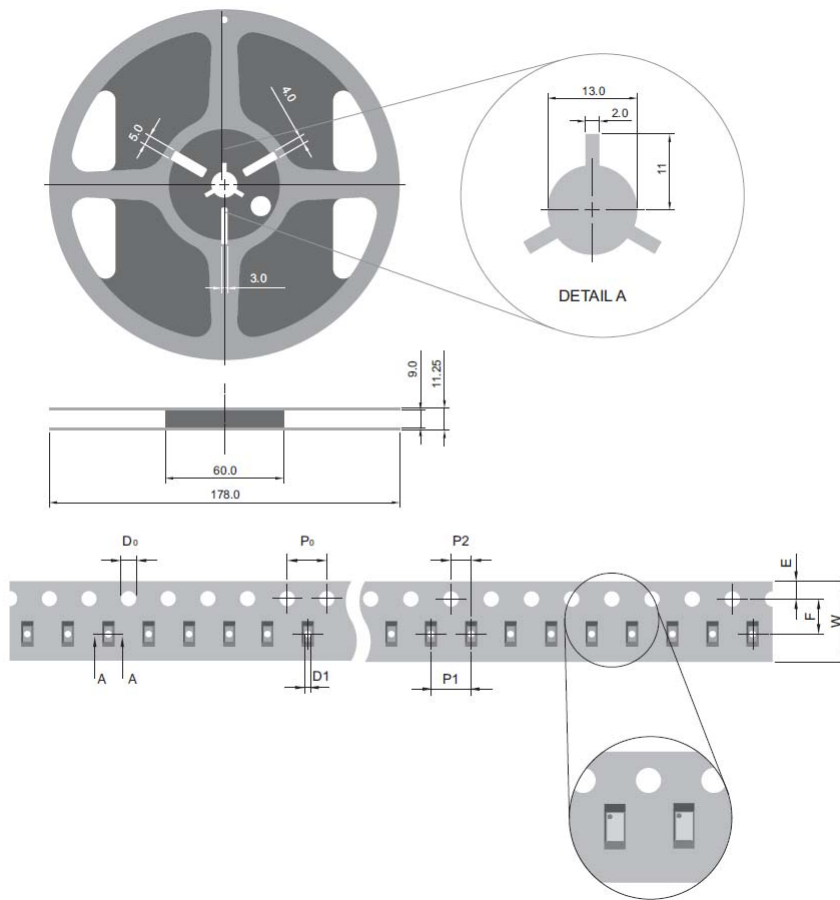

SYMBOL	mm
D ₀	1.55 ± 0.05
D ₁	0.50 ± 0.05
E	1.75 ± 0.10
F	3.50 ± 0.05
P ₀	4.00 ± 0.10
P ₁	4.00 ± 0.10
P ₂	2.00 ± 0.05
W	8.00 + 0.30 - 0.15

1. The product and product specifications contained herein are subject to change without notice to improve performance characteristics. Consult us, or our representatives before use, to confirm that the information in this datasheet is up to date.
2. The information in this datasheet is intended to illustrate the operation and characteristics of our products. We neither make warranties or representations with respect to the accuracy or completeness of the information contained in this datasheet nor grant any license to any intellectual property rights of ours or any third party concerning with the information in this datasheet.
3. Applicable export control laws and regulations should be complied and the procedures required by such laws and regulations should also be followed, when the product or any information contained in this datasheet is exported.
4. The product is neither intended nor warranted for use in equipment of systems which require extremely high levels of quality and/or reliability and/or a malfunction or failure which may cause loss of human life, bodily injury, serious property damage including but not limited to devices or equipment used in 1) nuclear facilities, 2) aerospace industry, 3) medical facilities, 4) automobile industry and other transportation industry and 5) safety devices and safety equipment to control combustions and explosions. Do not use the product for the above use unless agreed by us in writing in advance.
5. Although we make continuous efforts to improve the quality and reliability of our products; nevertheless Semiconductors are likely to fail with a certain probability. So in order to prevent personal injury and/or property damage resulting from such failure, customers are required to incorporate adequate safety measures in their designs, such as system fail safes, redundancy and fire prevention features.
6. Our products are not designed to be Radiation-resistant.
7. Please use the product listed in this datasheet within the specified ranges.
8. We assume no responsibility for damage or loss due to abnormal use.
9. All rights reserved. No part of this datasheet may be copied or reproduced unless agreed by Torex Semiconductor Ltd in writing in advance.

TOREX SEMICONDUCTOR LTD.

Данный компонент на территории Российской Федерации

Вы можете приобрести в компании MosChip.

Для оперативного оформления запроса Вам необходимо перейти по данной ссылке:

<http://moschip.ru/get-element>

Вы можете разместить у нас заказ для любого Вашего проекта, будь то серийное производство или разработка единичного прибора.

В нашем ассортименте представлены ведущие мировые производители активных и пассивных электронных компонентов.

Нашей специализацией является поставка электронной компонентной базы двойного назначения, продукции таких производителей как XILINX, Intel (ex.ALTERA), Vicor, Microchip, Texas Instruments, Analog Devices, Mini-Circuits, Amphenol, Glenair.

Сотрудничество с глобальными дистрибьюторами электронных компонентов, предоставляет возможность заказывать и получать с международных складов практически любой перечень компонентов в оптимальные для Вас сроки.

На всех этапах разработки и производства наши партнеры могут получить квалифицированную поддержку опытных инженеров.

Система менеджмента качества компании отвечает требованиям в соответствии с ГОСТ Р ИСО 9001, ГОСТ РВ 0015-002 и ЭС РД 009

Офис по работе с юридическими лицами:

105318, г.Москва, ул.Щербаковская д.3, офис 1107, 1118, ДЦ «Щербаковский»

Телефон: +7 495 668-12-70 (многоканальный)

Факс: +7 495 668-12-70 (доб.304)

E-mail: info@moschip.ru

Skype отдела продаж:

moschip.ru

moschip.ru_4

moschip.ru_6

moschip.ru_9