

# IS31LT3172/73

## 10-TO-200MA CONSTANT-CURRENT LED DRIVER

July 2016

### GENERAL DESCRIPTION

The IS31LT3172 and IS31LT3173 are adjustable linear current devices with excellent temperature stability. A single resistor is all that is required to set the operating current from 10mA to 200mA. The devices can operate from an input voltage from 2.5V to 42V with a minimal voltage headroom of 1V (typical). Designed with a low dropout voltage; the device can drive LED strings close to the supply voltage without switch capacitors or inductors.

The IS31LT3172/73 simplifies designs by providing a stable current without the additional requirement of input or output capacitors, inductors, FETs or diodes. The complete constant current driver requires only a current set resistor and a small PCB area making designs both efficient and cost effective.

The EN pin (3) of the IS31LT3172 can be tied to Vbat or BCM PWM signal for high side dimming. The EN Pin (3) of the IS31LT3173 can function as the PWM signal input used for low side dimming.

As a current sink it is ideal for LED lighting applications or current limiter for power supplies.

The device is provided in a lead (Pb) free, SOP-8-EP package.

### FEATURES

- Low-side current sink
  - Current preset to 10mA
  - Adjustable from 10mA to 200mA with external resistor selection
- Wide input voltage range from
  - 2.5V to 42V (IS31LT3173)
  - 5V to 42V (IS31LT3172)
 with a low dropout of typical 1V
- Up to 10kHz PWM input (IS31LT3173 only)
- Protection features:
  - 0.26%/K negative temperature coefficient at high temp for thermal protection
- Up to 1.8W power dissipation in a small SOP-8-EP package
- RoHS compliant (Pb-free) package

### APPLICATIONS

- Architectural LED lighting
- Channel letters for advertising, LED strips for decorative lighting
- Retail lighting in fridge, freezer case and vending machines
- Emergency lighting (e.g. steps lighting, exit way sign etc.)

### TYPICAL APPLICATION CIRCUIT

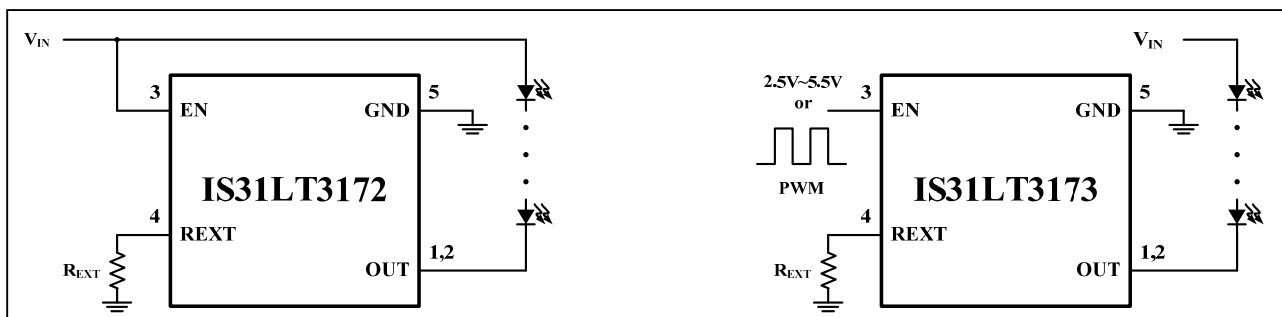
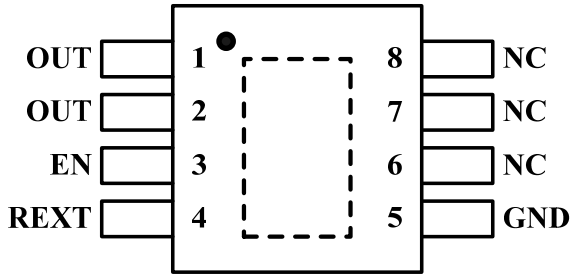

Figure 1 Typical Application Circuit

# IS31LT3172/73

## PIN CONFIGURATION

Package	Pin Configuration (Top View)
SOP-8-EP	

## PIN DESCRIPTION

No.	Pin	Description
1, 2	OUT	Current sink.
3	EN	Enable pin (PWM input IS31LT3173 only).
4	REXT	Optional current adjust.
5	GND	Ground.
6 ~ 8	NC	Floating or connect to GND.
	Thermal Pad	Connect to GND.



# IS31LT3172/73

## ORDERING INFORMATION

Industrial Range: -40°C to +125°C

Order Part No.	Package	QTY/Reel
IS31LT3172-GRLS4-TR IS31LT3173-GRLS4-TR	SOP-8-EP, Lead-free	2500

Copyright © 2016 Integrated Silicon Solution, Inc. All rights reserved. ISSI reserves the right to make changes to this specification and its products at any time without notice. ISSI assumes no liability arising out of the application or use of any information, products or services described herein. Customers are advised to obtain the latest version of this device specification before relying on any published information and before placing orders for products. Integrated Silicon Solution, Inc. does not recommend the use of any of its products in life support applications where the failure or malfunction of the product can reasonably be expected to cause failure of the life support system or to significantly affect its safety or effectiveness. Products are not authorized for use in such applications unless Integrated Silicon Solution, Inc. receives written assurance to its satisfaction, that:

- a.) the risk of injury or damage has been minimized;
- b.) the user assume all such risks; and
- c.) potential liability of Integrated Silicon Solution, Inc is adequately protected under the circumstances

# IS31LT3172/73

## ABSOLUTE MAXIMUM RATINGS (Note 1)

Maximum enable voltage, $V_{EN(MAX)}$ only for IS31LT3172-GRLS4-TR $V_{EN(MAX)}$ only for IS31LT3173-GRLS4-TR	45V 6V
Maximum output current, $I_{OUT(MAX)}$	200mA
Maximum output voltage, $V_{OUT(MAX)}$	45V
Reverse voltage between all terminals, $V_R$	0.5V
Power dissipation, $P_{D(MAX)}$ (Note 2)	1.8W
Maximum junction temperature, $T_{JMAX}$	150°C
Storage temperature range, $T_{STG}$	-65°C ~ +150°C
Operating temperature range, $T_A$	-40°C ~ +125°C
ESD (HBM) IS31LT3172-GRLS4-TR	±2kV
ESD (HBM) IS31LT3173-GRLS4-TR	±1.5kV
ESD (CDM)	±500V

### Note 1:

Stresses beyond those listed under “Absolute Maximum Ratings” may cause permanent damage to the device. These are stress ratings only and functional operation of the device at these or any other condition beyond those indicated in the operational sections of the specifications is not implied. Exposure to absolute maximum rating conditions for extended periods may affect device reliability.

### Note 2:

Detail information please refer to package thermal de-rating curve on Page 14.

## THERMAL CHARACTERISTICS

Characteristic	Test Conditions	Value
Package Thermal Resistance (Junction to Ambient), $R_{\theta JA}$	On 4-layer PCB based on JEDEC standard at 1W, $T_A=25^\circ\text{C}$	55.4°C/W
Package Thermal Resistance (Junction to Pad), $R_{\theta JP}$		2.24°C/W

## ELECTRICAL CHARACTERISTICS

“●” This symbol in the table means these parameters are for IS31LT3172-GRLS4-TR.

“○” This symbol in the table means these parameters are for IS31LT3173-GRLS4-TR.

Test condition is  $T_A = T_J = 25^\circ\text{C}$ , unless otherwise specified. (Note 3)

Symbol	Parameter	Condition	Min.	Typ.	Max.	Unit	
$V_{BD\_OUT}$	OUT pin breakdown voltage	$V_{EN} = 0V$		42		V	
$I_{EN}$	Enable current	$V_{EN} = 24V$	●		0.35	Ma	
		$V_{EN} = 3.3V$	○		0.35		
$R_{INT}$	Internal resistor	$I_{RINT} = 10\text{Ma}$			106	Ω	
$I_{OUT}$	Output current	$V_{OUT} = 1.4V, V_{EN} = 24V, R_{EXT} \text{ OPEN}$	●	9	10	11	Ma
		$V_{OUT} = 1.4V, V_{EN} = 3.3V, R_{EXT} \text{ OPEN}$	○	9	10	11	
		$V_{OUT} > 2.0V, V_{EN} = 24V, R_{EXT} = 10\Omega$	●	105	118	130	Ma
		$V_{OUT} > 2.0V, V_{EN} = 3.3V, R_{EXT} = 10\Omega$	○	105	118	130	
	Output current Range (Note 4, 5)	$V_{OUT} > 2.0V, V_{EN} = 24V$	●	10		200	Ma
		$V_{OUT} > 2.0V, V_{EN} = 3.3V$	○	10		200	

# IS31LT3172/73

## DC CHARACTERISTICS WITH STABILIZED LED LOAD

“●” This symbol in the table means these parameters are for IS31LT3172-GRLS4-TR.

“○” This symbol in the table means these parameters are for IS31LT3173-GRLS4-TR.

Test condition is  $T_A = T_J = 25^{\circ}\text{C}$ , unless otherwise specified. (Note 3)

Symbol	Parameter	Condition		Min.	Typ.	Max.	Unit
$V_S$	Sufficient supply voltage on EN pin		●	5		42	V
			○	2.5		5.5	
$V_{HR}$	Lowest sufficient headroom voltage on OUT pin	$I_{OUT} = 100\text{Ma}$			1	1.2	V
$\Delta I_{OUT}/I_{OUT}$ (Note 4)	Output current change versus ambient temp change	$V_{OUT} > 2.0\text{V}, V_{EN} = 24\text{V}, R_{EXT} = 10\Omega$	●		-0.26		%K
			○		-0.26		
	Output current change versus $V_{out}$	$V_{OUT} > 2.0\text{V}, V_{EN} = 24\text{V}, R_{EXT} = 10\Omega$	●		1.9		%V
			○		1.9		

**Note 3:**

Production testing of the device is performed at  $25^{\circ}\text{C}$ . Functional operation of the device and parameters specified over  $-40^{\circ}\text{C}$  to  $+125^{\circ}\text{C}$  temperature range, are guaranteed by design and characterization.

**Note 4:**

Guaranteed by design.

**Note 5:**

The maximum output current is dependent on the PCB board design, air flow, ambient temperature and power dissipation in the device. Please refer to the package thermal de-rating curve on Page 14 for more detail information.

# IS31LT3172/73

## FUNCTIONAL BLOCK DIAGRAM

IS31LT3172

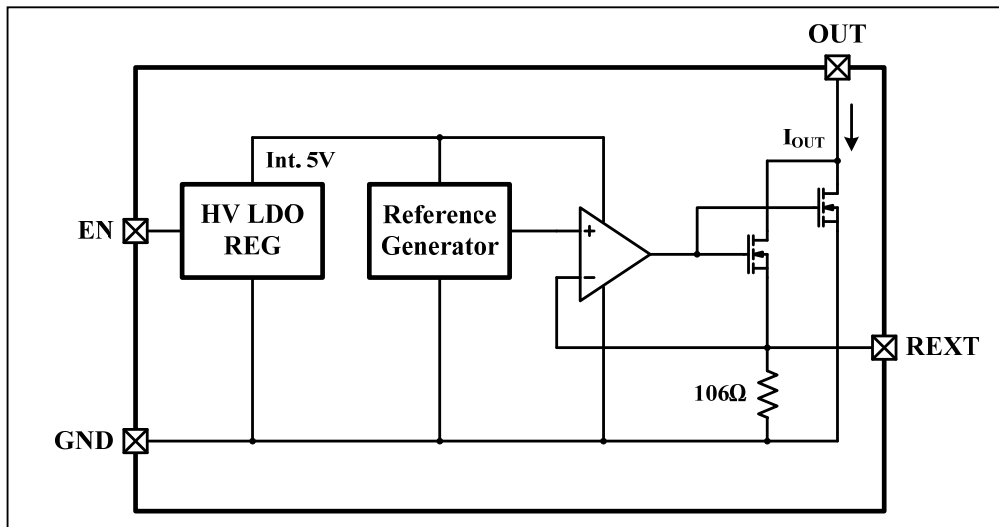

IS31LT3173

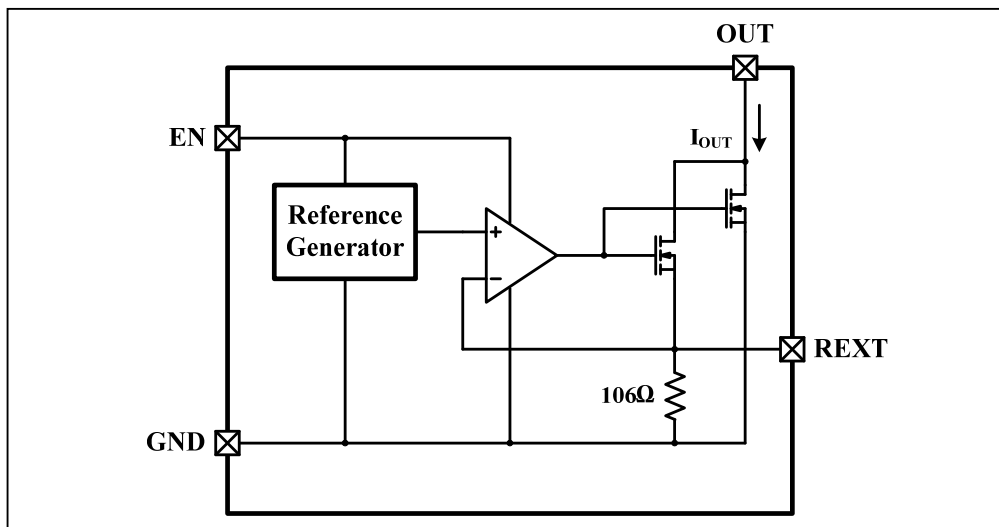

# IS31LT3172/73

## TYPICAL PERFORMANCE CHARACTERISTICS

### IS31LT3172

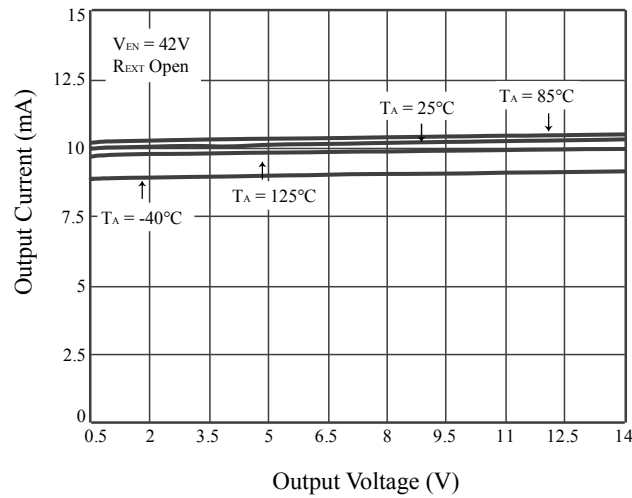

Figure 2 I<sub>OUT</sub> vs. V<sub>OUT</sub>

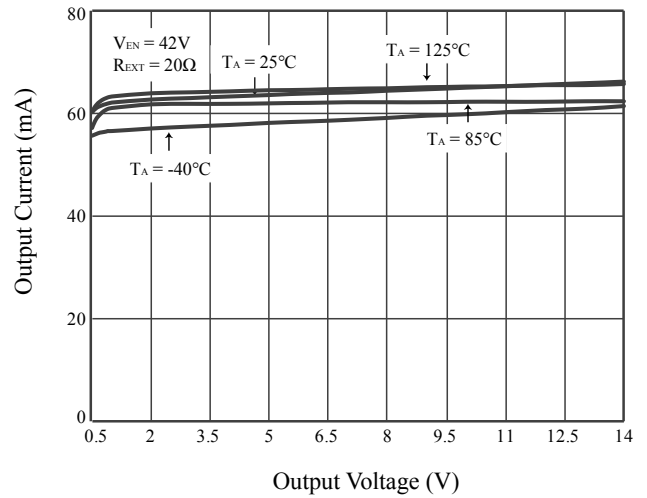

Figure 3 I<sub>OUT</sub> vs. V<sub>OUT</sub>

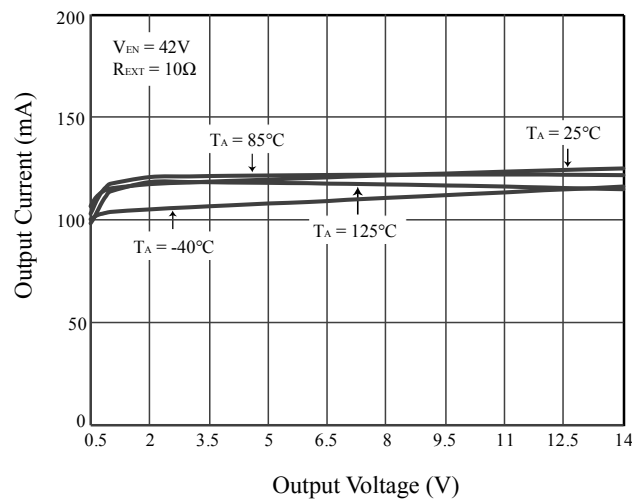

Figure 4 I<sub>OUT</sub> vs. V<sub>OUT</sub>

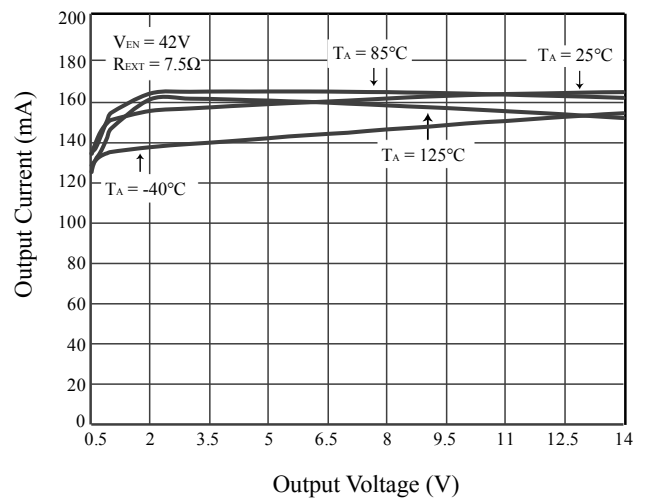

Figure 5 I<sub>OUT</sub> vs. V<sub>OUT</sub>

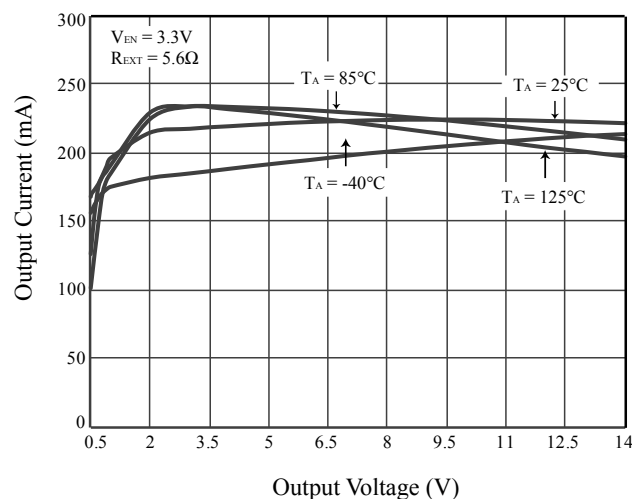

Figure 6 I<sub>OUT</sub> vs. V<sub>OUT</sub>

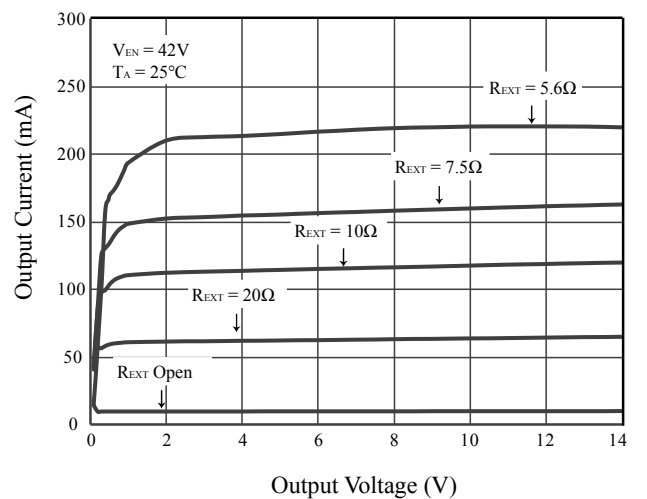
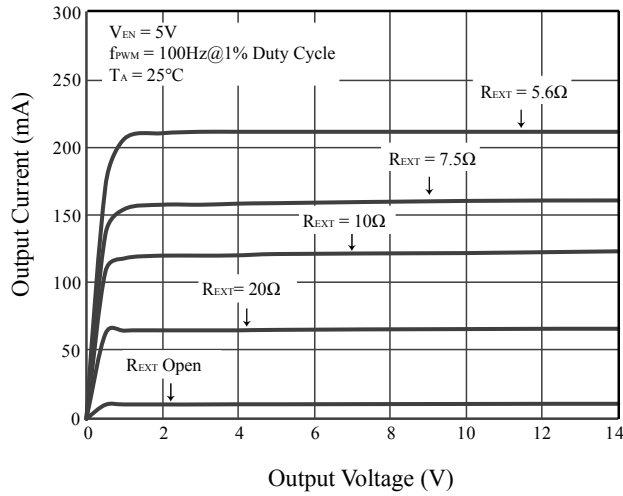
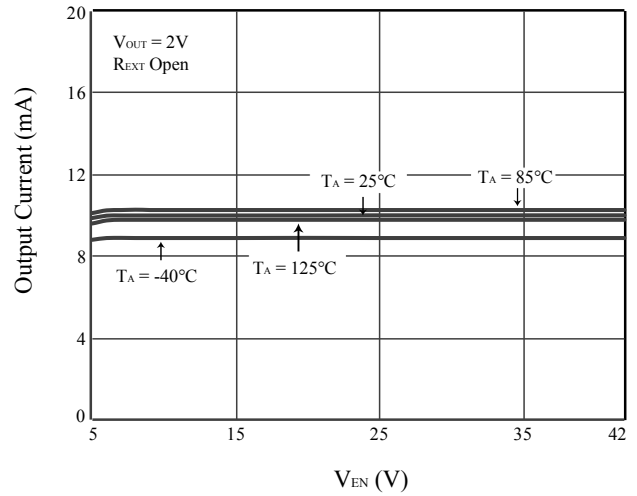

Figure 7 I<sub>OUT</sub> vs. V<sub>OUT</sub>



**Figure 8**  $I_{OUT}$  vs.  $V_{OUT}$



**Figure 9**  $I_{OUT}$  vs.  $V_{EN}$

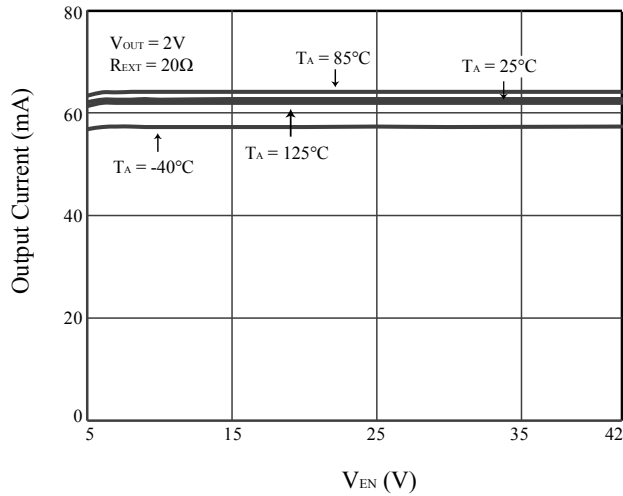

**Figure 10**  $I_{OUT}$  vs.  $V_{EN}$

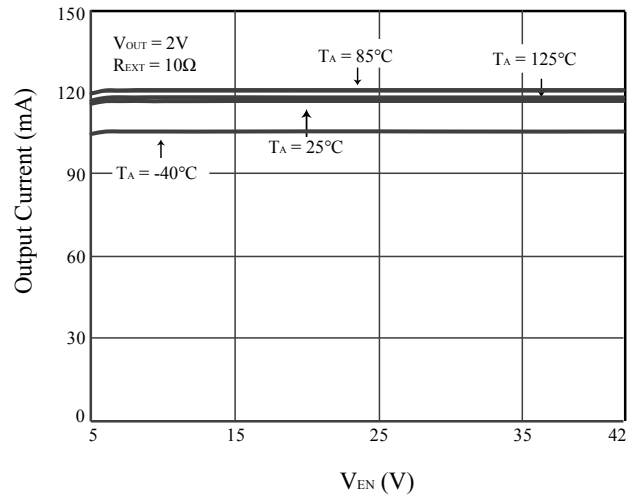

**Figure 11**  $I_{OUT}$  vs.  $V_{EN}$

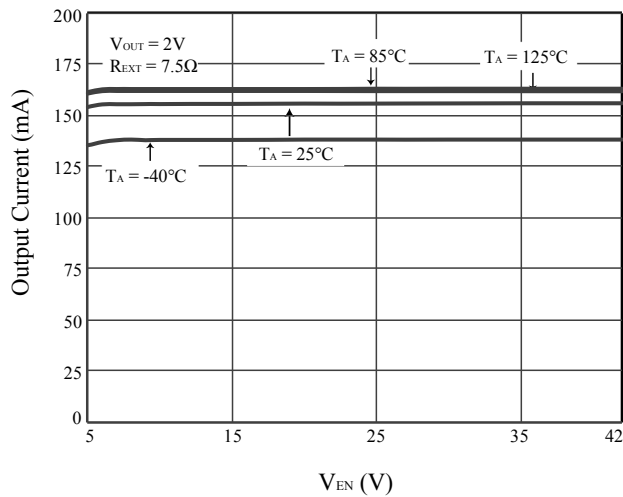

**Figure 12**  $I_{OUT}$  vs.  $V_{EN}$

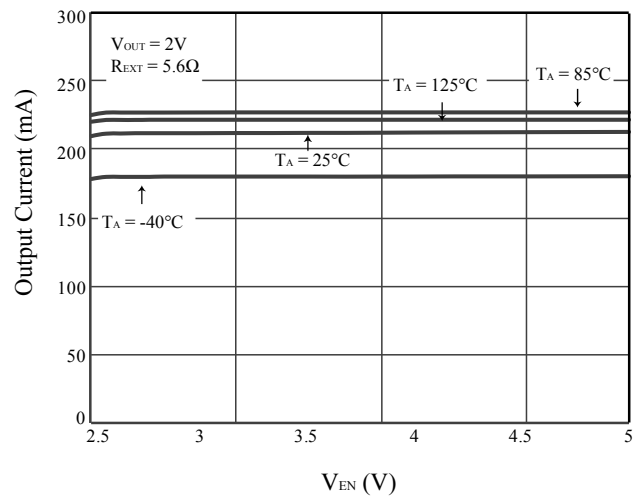

**Figure 13**  $I_{OUT}$  vs.  $V_{EN}$



# IS31LT3172/73

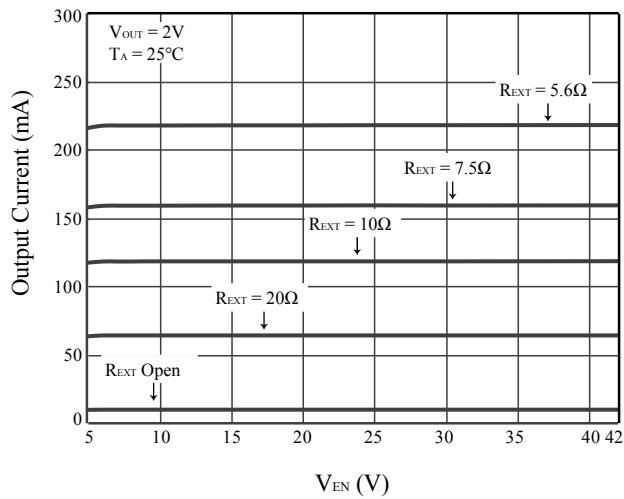

Figure 14  $I_{OUT}$  vs.  $V_{EN}$

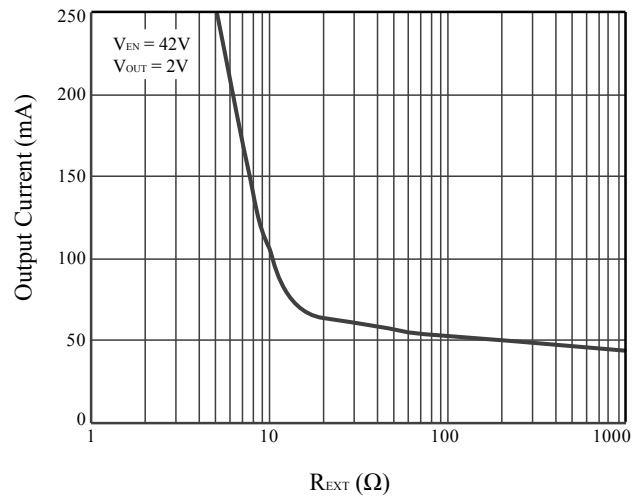

Figure 15  $I_{OUT}$  vs.  $R_{EXT}$

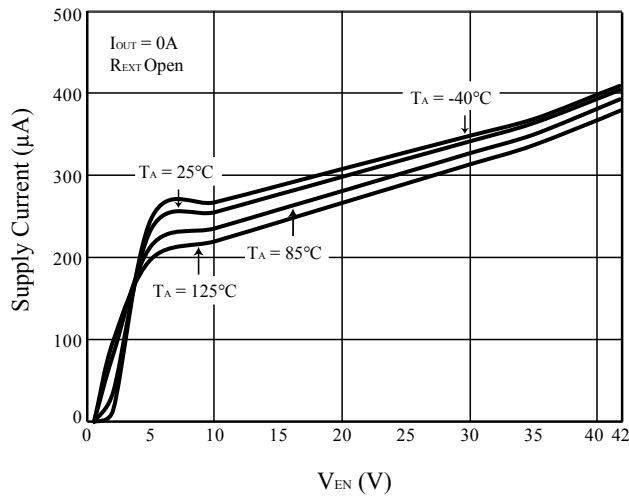

Figure 16  $I_{EN}$  vs.  $V_{EN}$

# IS31LT3172/73

## IS31LT3173

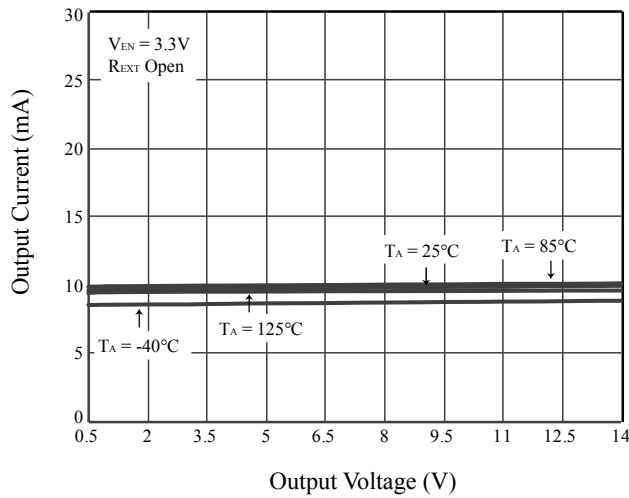

Figure 17  $I_{OUT}$  vs.  $V_{OUT}$

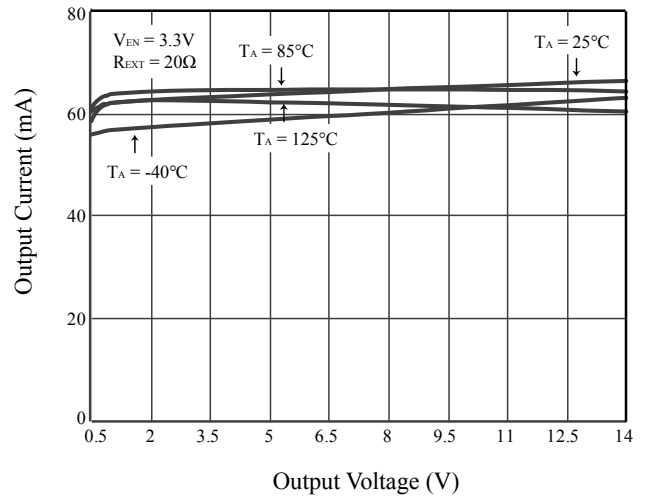

Figure 18  $I_{OUT}$  vs.  $V_{OUT}$

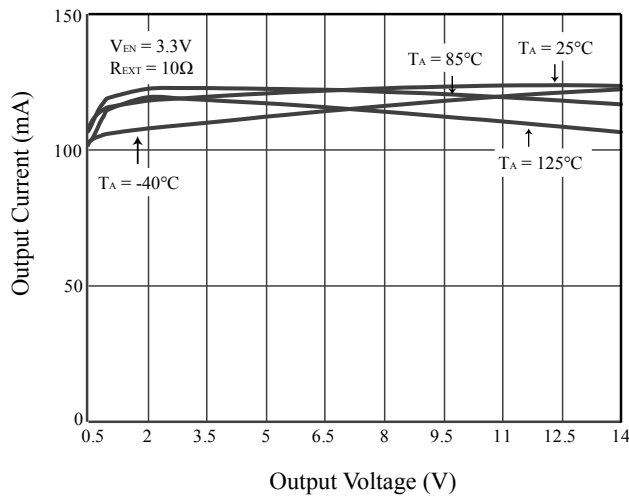

Figure 19  $I_{OUT}$  vs.  $V_{OUT}$

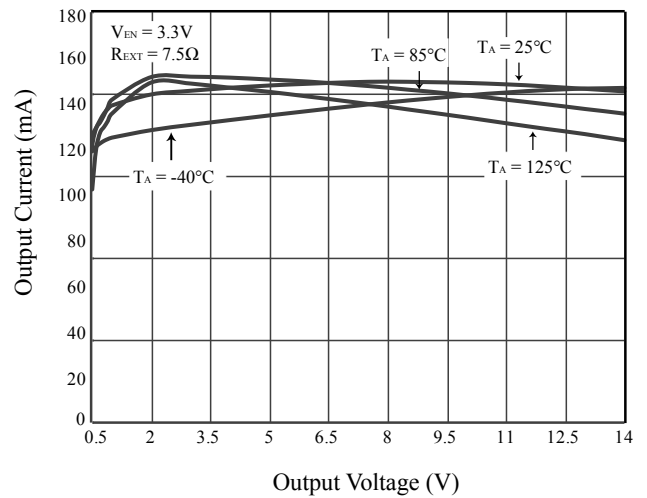

Figure 20  $I_{OUT}$  vs.  $V_{OUT}$

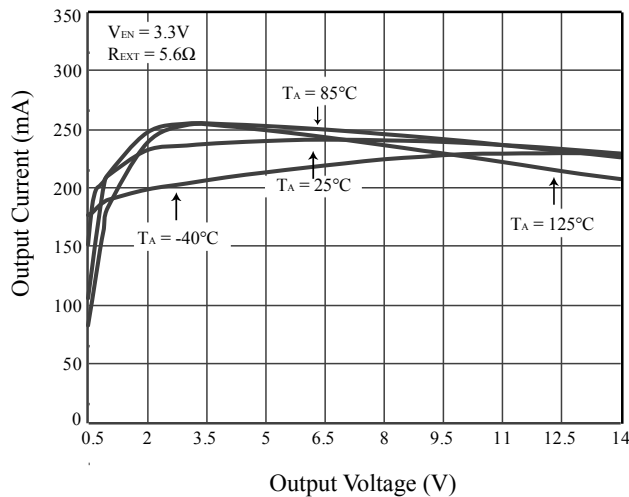

Figure 21  $I_{OUT}$  vs.  $V_{OUT}$

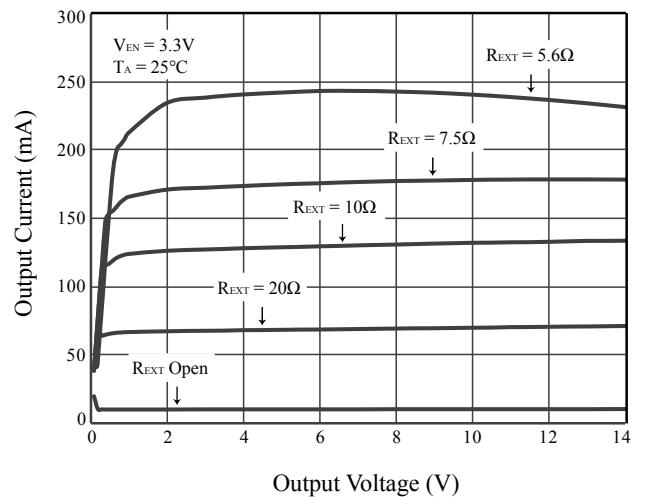
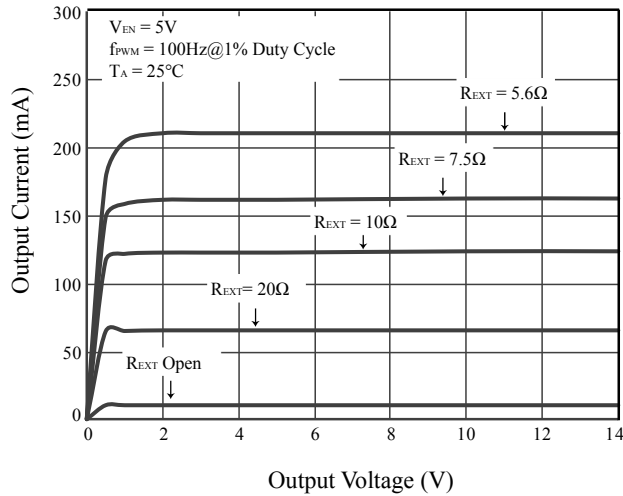
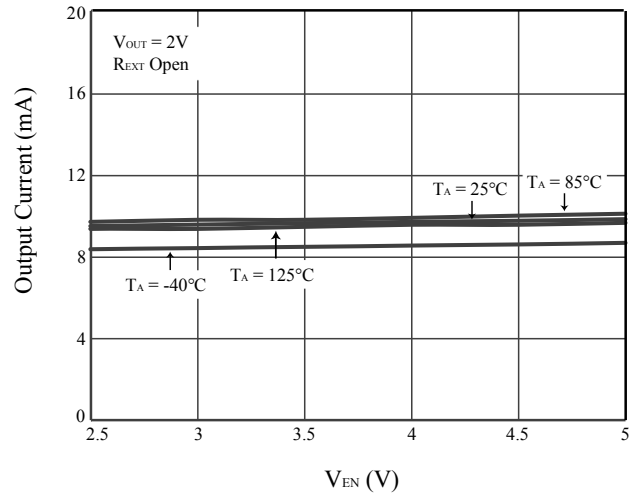

Figure 22  $I_{OUT}$  vs.  $V_{OUT}$



**Figure 23**  $I_{OUT}$  vs.  $V_{OUT}$



**Figure 24**  $I_{OUT}$  vs.  $V_{EN}$

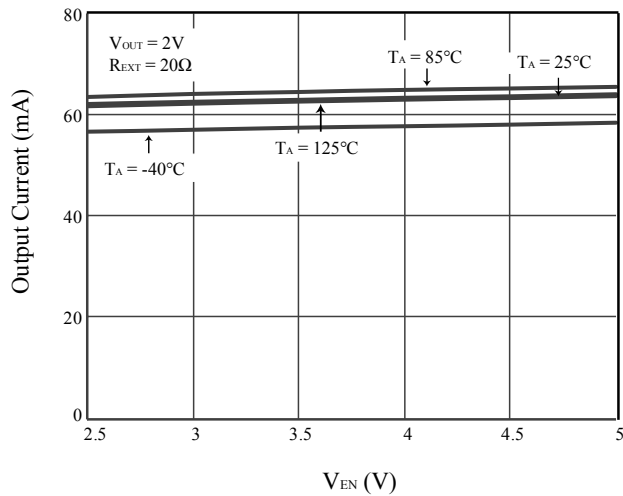

**Figure 25**  $I_{OUT}$  vs.  $V_{EN}$

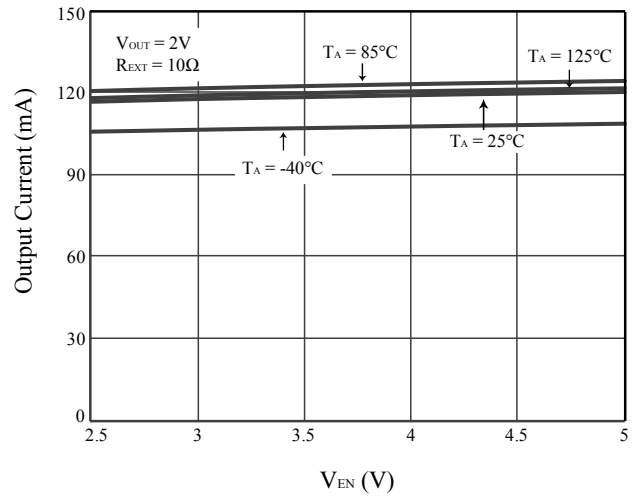

**Figure 26**  $I_{OUT}$  vs.  $V_{EN}$

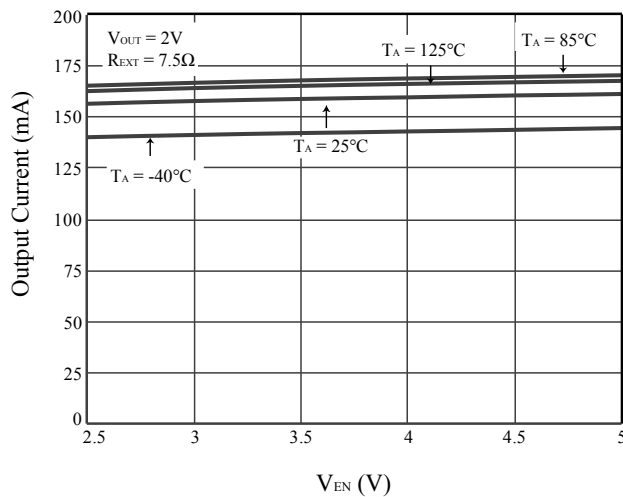

**Figure 27**  $I_{OUT}$  vs.  $V_{EN}$

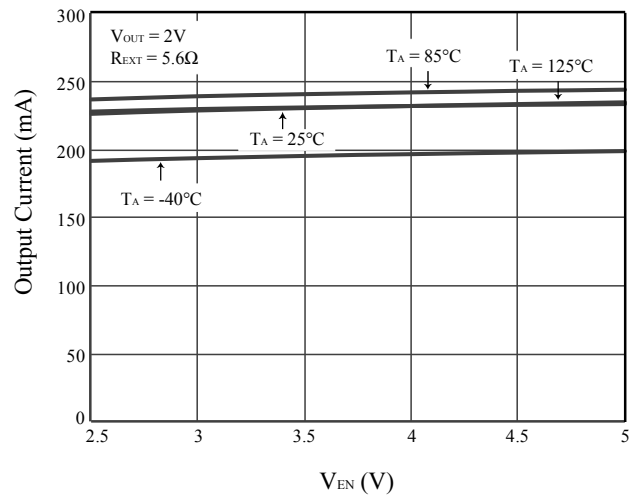

**Figure 28**  $I_{OUT}$  vs.  $V_{EN}$

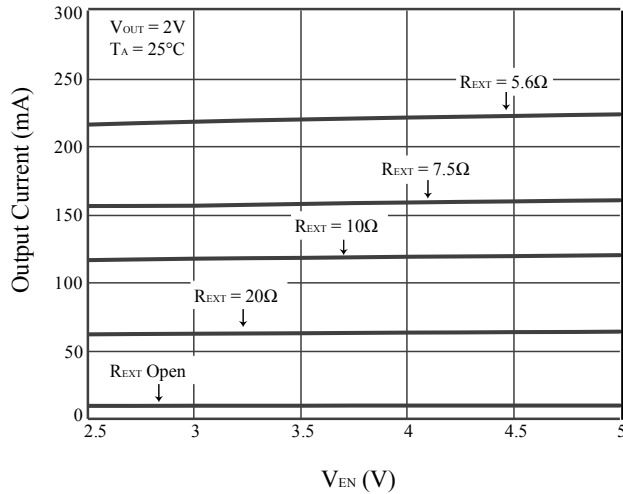

**Figure 29** I<sub>OUT</sub> vs. V<sub>EN</sub>

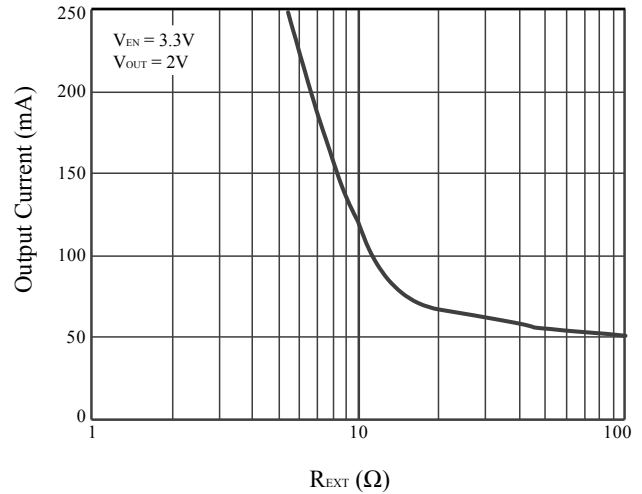

**Figure 30** I<sub>OUT</sub> vs. R<sub>EXT</sub>

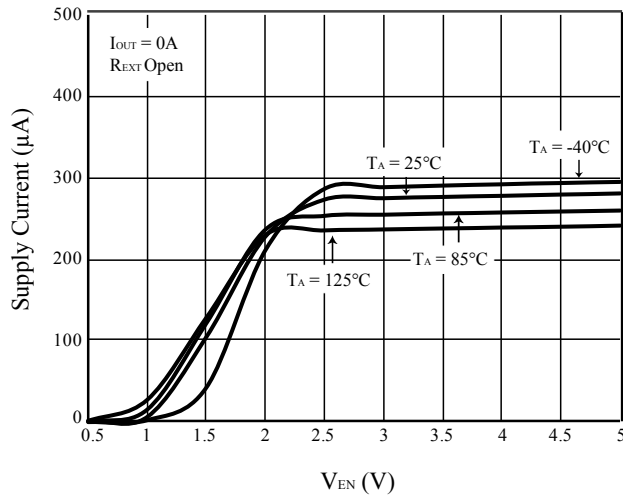

**Figure 31** I<sub>EN</sub> vs. V<sub>EN</sub>

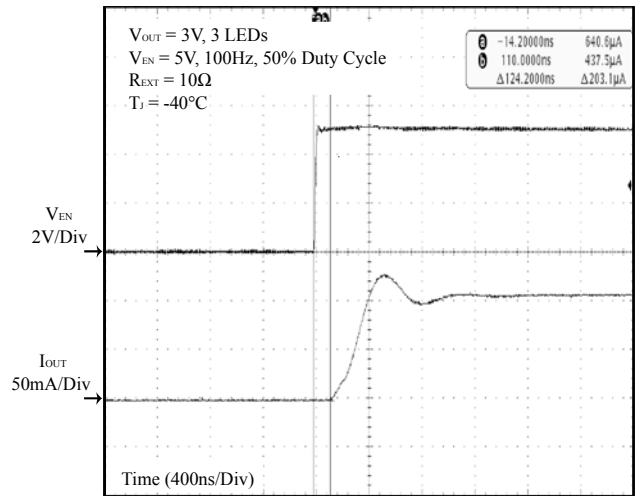

**Figure 32** V<sub>EN</sub> vs. I<sub>OUT</sub> Delay and Rising Edge

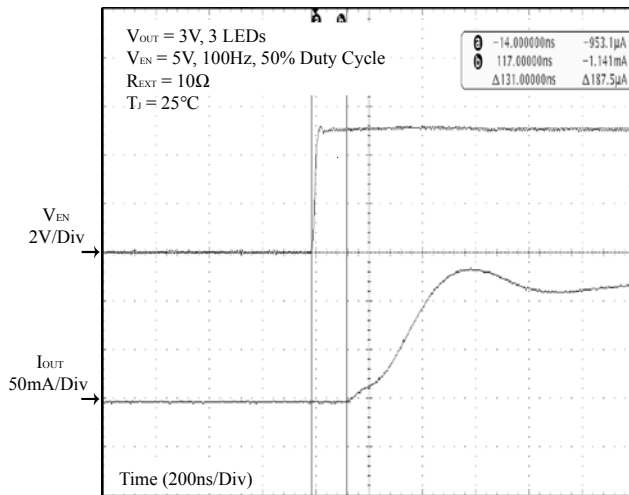

**Figure 33** V<sub>EN</sub> vs. I<sub>OUT</sub> Delay and Rising Edge

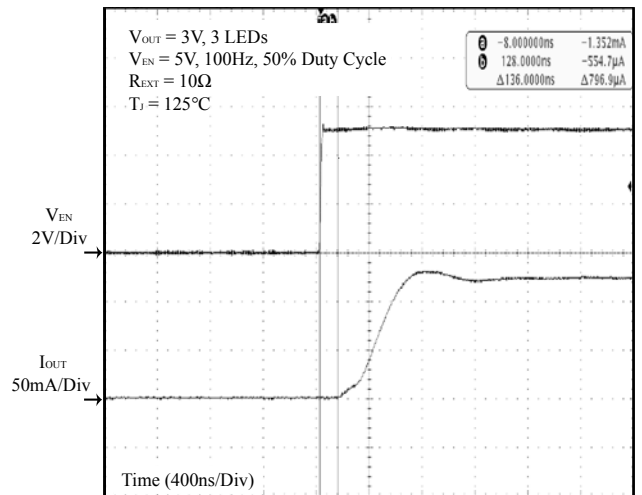

**Figure 34** V<sub>EN</sub> vs. I<sub>OUT</sub> Delay and Rising Edge

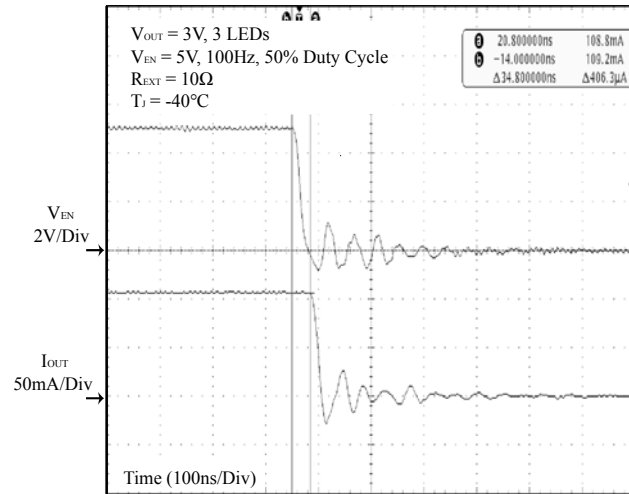

Figure 35  $V_{EN}$  vs.  $I_{OUT}$  Delay and Falling Edge

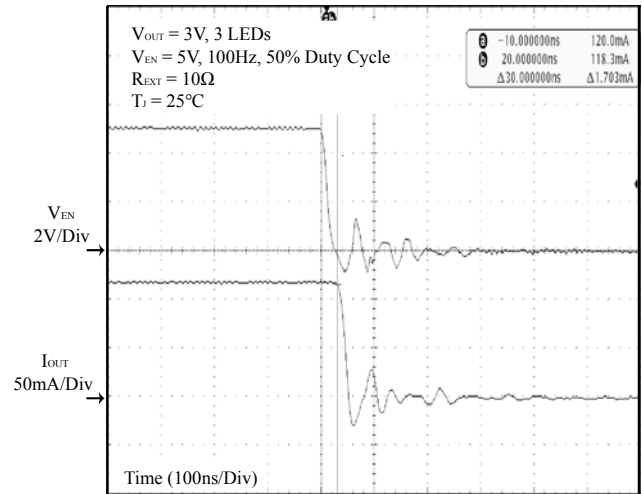

Figure 36  $V_{EN}$  vs.  $I_{OUT}$  Delay and Falling Edge

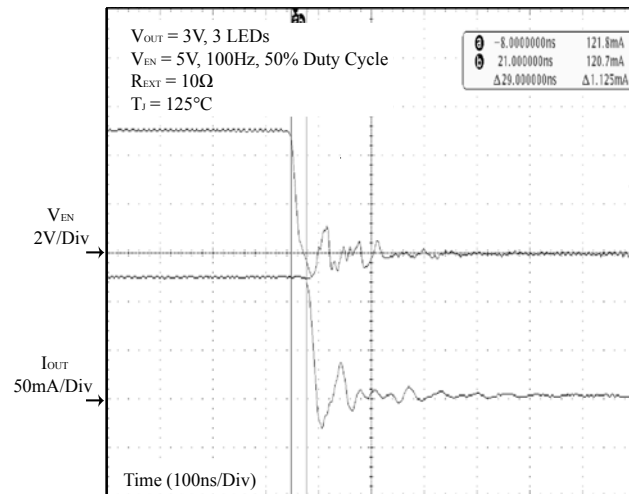

Figure 37  $V_{EN}$  vs.  $I_{OUT}$  Delay and Falling Edge

# IS31LT3172/73

## APPLICATIONS INFORMATION

IS31LT3172/73 provides an easy constant current source solution for LED lighting applications. It uses an external resistor to adjust the LED current from 10Ma to 200Ma. The LED current can be determined by the external resistor  $R_{EXT}$  as Equation (1):

$$R_{EXT} = \frac{10mA \times 106\Omega}{I_{SET} - 10mA} \quad (1)$$

Where  $I_{SET}$  is in Ma.

Paralleling a low tolerance resistor  $R_{EXT}$  with the internal resistor  $R_{INT}$  will improve the overall accuracy of the current sense resistance. The resulting output current will vary slightly lower due to the negative temperature coefficient (NTC) resulting from the self heating of the IS31LT3172/73.

### HIGH INPUT VOLTAGE APPLICATION

When driving a long string of LEDs whose total forward voltage drop exceeds the IS31LT3172  $V_{BD\_OUT}$  limit of 42V, it is possible to stack several LEDs (such as 2 LEDs) between the EN pin and the OUT pins, and so the voltage on the EN pin is higher than 5V. The remaining string of LEDs can then be placed between power supply  $+V_S$  and EN pin, (Figure 38). The number of LEDs required to stack at EN pin will depend on the LED's forward voltage drop ( $V_F$ ) and the  $+V_S$  value.

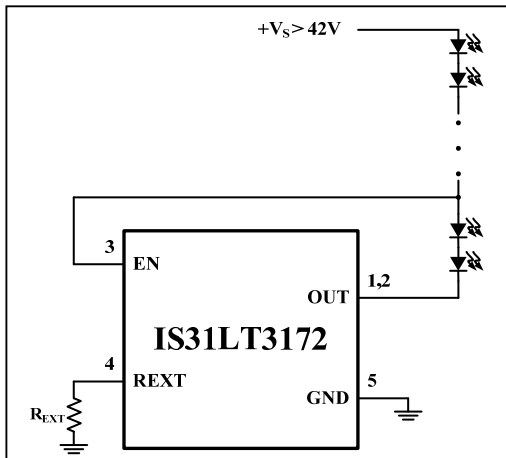

Figure 38 High Input Voltage Application Circuit

Note: when operating the IS31LT3172 at voltages exceeding the device operating limits, care needs to be taken to keep the EN pin and OUT pin voltage below 42V.

### THERMAL PROTECTION AND DISSIPATION

The IS31LT3172/73 implements thermal foldback protection to reduce the LED current when the package's thermal dissipation is exceeded and prevent "thermal runaway". The thermal foldback implements a negative temperature coefficient (NTC) of  $-0.26\%/K$ .

When operating the chip at high ambient temperatures, or when driving maximum load current, care must be taken to avoid exceeding the package power dissipation limits. Exceeding the package dissipation will cause the device to enter thermal protection mode. The maximum package power dissipation can be calculated using the following Equation (2):

$$P_{D(MAX)} = \frac{T_{J(MAX)} - T_A}{\theta_{JA}} \quad (2)$$

Where  $T_{J(MAX)}$  is the maximum junction temperature,  $T_A$  is the ambient temperature, and  $\theta_{JA}$  is the junction to ambient thermal resistance; a metric for the relative thermal performance of a package.

The recommended maximum operating junction temperature,  $T_{J(MAX)}$ , is  $125^\circ C$  and so the maximum ambient temperature is determined by the package parameter;  $\theta_{JA}$ . The  $\theta_{JA}$  for the IS31LT3172/73 SOP-8-EP package is  $55.4^\circ C/W$ .

Therefore the maximum power dissipation at  $T_A = 25^\circ C$  is:

$$P_{D(MAX)} = \frac{125^\circ C - 25^\circ C}{55.4^\circ C/W} \approx 1.8W$$

The actual power dissipation  $P_D$  is:

$$P_D = V_{OUT} \times I_{OUT} + V_{EN} \times I_{EN} \quad (3)$$

To ensure the performance, the die temperature ( $T_J$ ) of the IS31LT3172/73 should not exceed  $125^\circ C$ . The graph below gives details for the package power derating.

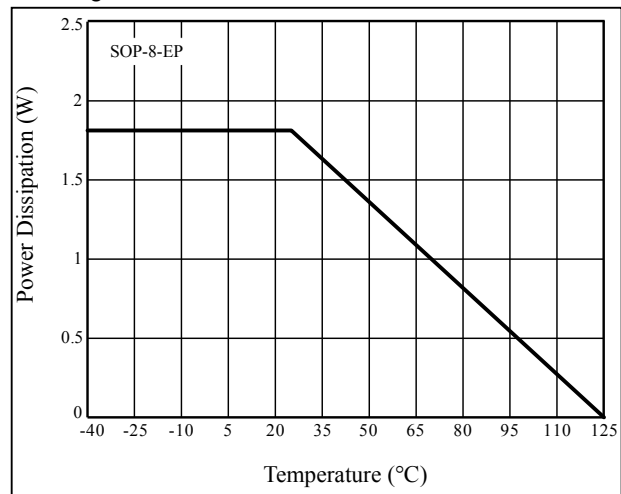
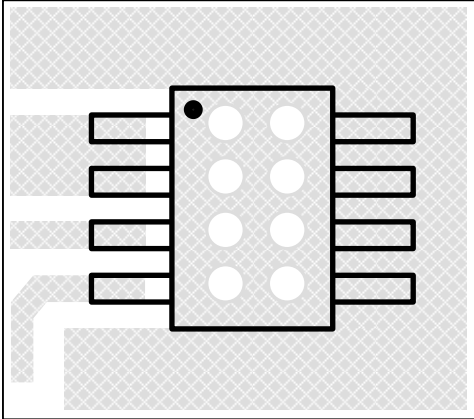

Figure 39  $P_D$  vs.  $T_A$  (SOP-8-EP)

The thermal resistance is achieved by mounting the IS31LT3172/73 on a standard FR4 double-sided printed circuit board (PCB) with a copper area of a few square inches on each side of the board under

## IS31LT3172/73

the IS31LT3172/73. Multiple thermal vias, as shown in Figure 40, help to conduct the heat from the exposed pad of the IS31LT3172/73 to the copper on each side of the board. The thermal resistance can be reduced by using a metal substrate or by adding a heatsink.



**Figure 40** Board Via Layout For Thermal Dissipation

# IS31LT3172/73

## CLASSIFICATION REFLOW PROFILES

Profile Feature	Pb-Free Assembly
Preheat & Soak	
Temperature min (T <sub>smin</sub> )	150°C
Temperature max (T <sub>smax</sub> )	200°C
Time (T <sub>smin</sub> to T <sub>smax</sub> ) (t <sub>s</sub> )	60-120 seconds
Average ramp-up rate (T <sub>smax</sub> to T <sub>p</sub> )	3°C/second max.
Liquidous temperature (T <sub>L</sub> )	217°C
Time at liquidous (T <sub>L</sub> )	60-150 seconds
Peak package body temperature (T <sub>p</sub> )*	Max 260°C
Time (t <sub>p</sub> )** within 5°C of the specified classification temperature (T <sub>c</sub> )	Max 30 seconds
Average ramp-down rate (T <sub>p</sub> to T <sub>smax</sub> )	6°C/second max.
Time 25°C to peak temperature	8 minutes max.

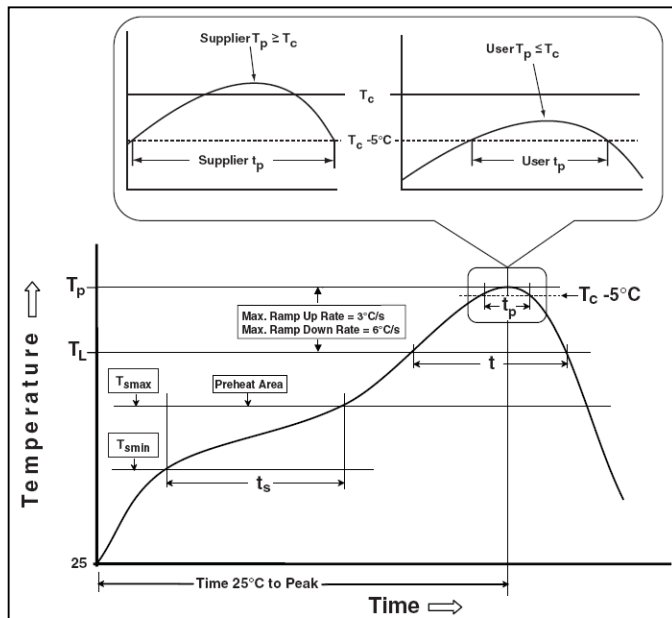

Figure 41 Classification Profile



# IS31LT3172/73

## PACKAGE INFORMATION

### SOP-8-EP

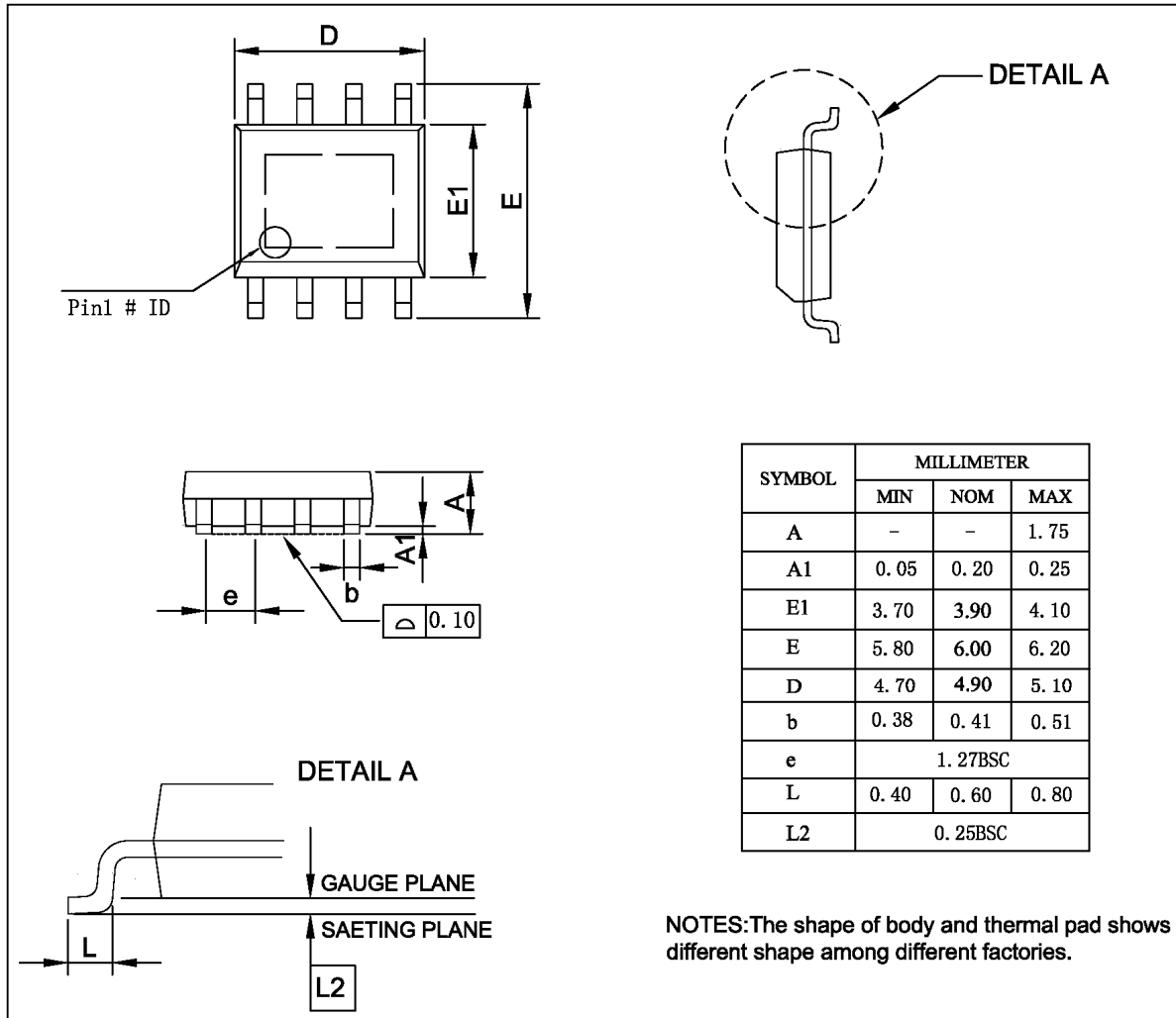

# IS31LT3172/73

## RECOMMENDED LAND PATTERN

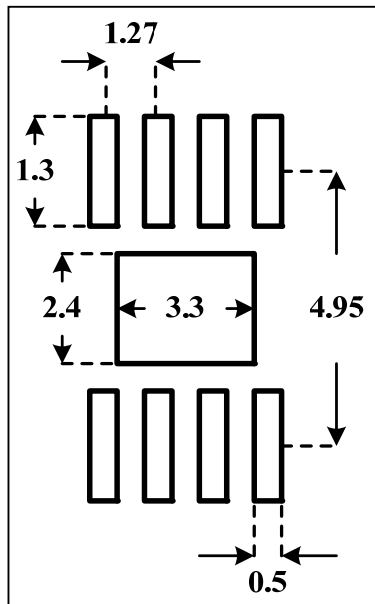

**Note:**

1. Land pattern complies to IPC-7351.
2. All dimensions in MM.
3. This document (including dimensions, notes & specs) is a recommendation based on typical circuit board manufacturing parameters. Since land pattern design depends on many factors unknown (eg. User's board manufacturing specs), user must determine suitability for use.



# IS31LT3172/73

## REVISION HISTORY

Revision	Detail Information	Date
A	Initial release	2016.03.01
B	Update EC table	2016.05.04
C	Add Package Thermal Resistance (Junction to Pad), $R_{\theta JP}$ in THERMAL CHARACTERISTICS	2016.07.01

## Данный компонент на территории Российской Федерации

### Вы можете приобрести в компании MosChip.

Для оперативного оформления запроса Вам необходимо перейти по данной ссылке:

<http://moschip.ru/get-element>

Вы можете разместить у нас заказ для любого Вашего проекта, будь то серийное производство или разработка единичного прибора.

В нашем ассортименте представлены ведущие мировые производители активных и пассивных электронных компонентов.

Нашей специализацией является поставка электронной компонентной базы двойного назначения, продукции таких производителей как XILINX, Intel (ex.ALTERA), Vicor, Microchip, Texas Instruments, Analog Devices, Mini-Circuits, Amphenol, Glenair.

Сотрудничество с глобальными дистрибьюторами электронных компонентов, предоставляет возможность заказывать и получать с международных складов практически любой перечень компонентов в оптимальные для Вас сроки.

На всех этапах разработки и производства наши партнеры могут получить квалифицированную поддержку опытных инженеров.

Система менеджмента качества компании отвечает требованиям в соответствии с ГОСТ Р ИСО 9001, ГОСТ РВ 0015-002 и ЭС РД 009

### Офис по работе с юридическими лицами:

105318, г.Москва, ул.Щербаковская д.3, офис 1107, 1118, ДЦ «Щербаковский»

Телефон: +7 495 668-12-70 (многоканальный)

Факс: +7 495 668-12-70 (доб.304)

E-mail: [info@moschip.ru](mailto:info@moschip.ru)

Skype отдела продаж:

moschip.ru

moschip.ru\_4

moschip.ru\_6

moschip.ru\_9