



A New Direction in Mixed-Signal

July 2013

# XRP7740EVB-HIC

## Four Channel Digital PWM Demo Boards

Rev. 1.0.0

### GENERAL DESCRIPTION

The XRP7740EVB-HIC Demo board is a complete, four channel, power system measuring 3.25" x 5" capable of delivering over 60 watts. It provides 1.5V, 1.0V 1.8V and 1.0V at a maximum of 8A, 30A, 5A and 12A on channels 1 through 4 respectively. All power supply operations can be controlled over an I<sup>2</sup>C interface. The supplies can be adjusted in 50mV increments for voltages up to 2.5V and in 100mV increments for voltages from 2.6V to 5.1V. The order and ramp rates for each supply can be programmed to accommodate any sequencing requirement. Faults, output voltages and currents can also be monitored. Four GPIOs are available and can be programmed to provide status of power good signals, faults, and warnings or as enable inputs. Unused GPIO pins can be programmed as I/O expansion for a microcontroller. The board is supported by PowerArchitect™ 4.21 and plugs directly onto the Exar Configuration Module (XRP77XXEVB-XCM).

### EVALUATION BOARD MANUAL

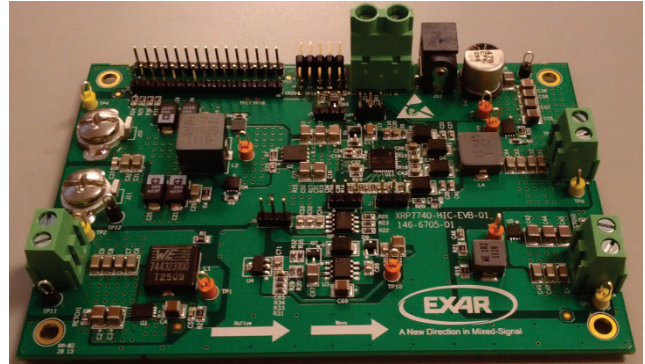

Figure 1: XRP7740EVB-HiC Demo Board

### FEATURES

- **XRP7740 Programmable Controller**
- **4 Channel Power System**
- **Wide Input Voltage Range: 4.5V-20V**
- **Over 60W Capable**
- **Form Factor: 3.25" x 5"**
- **Uses PowerArchitect™ 4.21**
- **I<sup>2</sup>C Interface**
  - Programming
  - Monitoring
  - Control



A New Direction in Mixed-Signal

# XRP7740EVB-HIC

## Four Channel Digital PWM Demo Boards

### EVALUATION BOARD

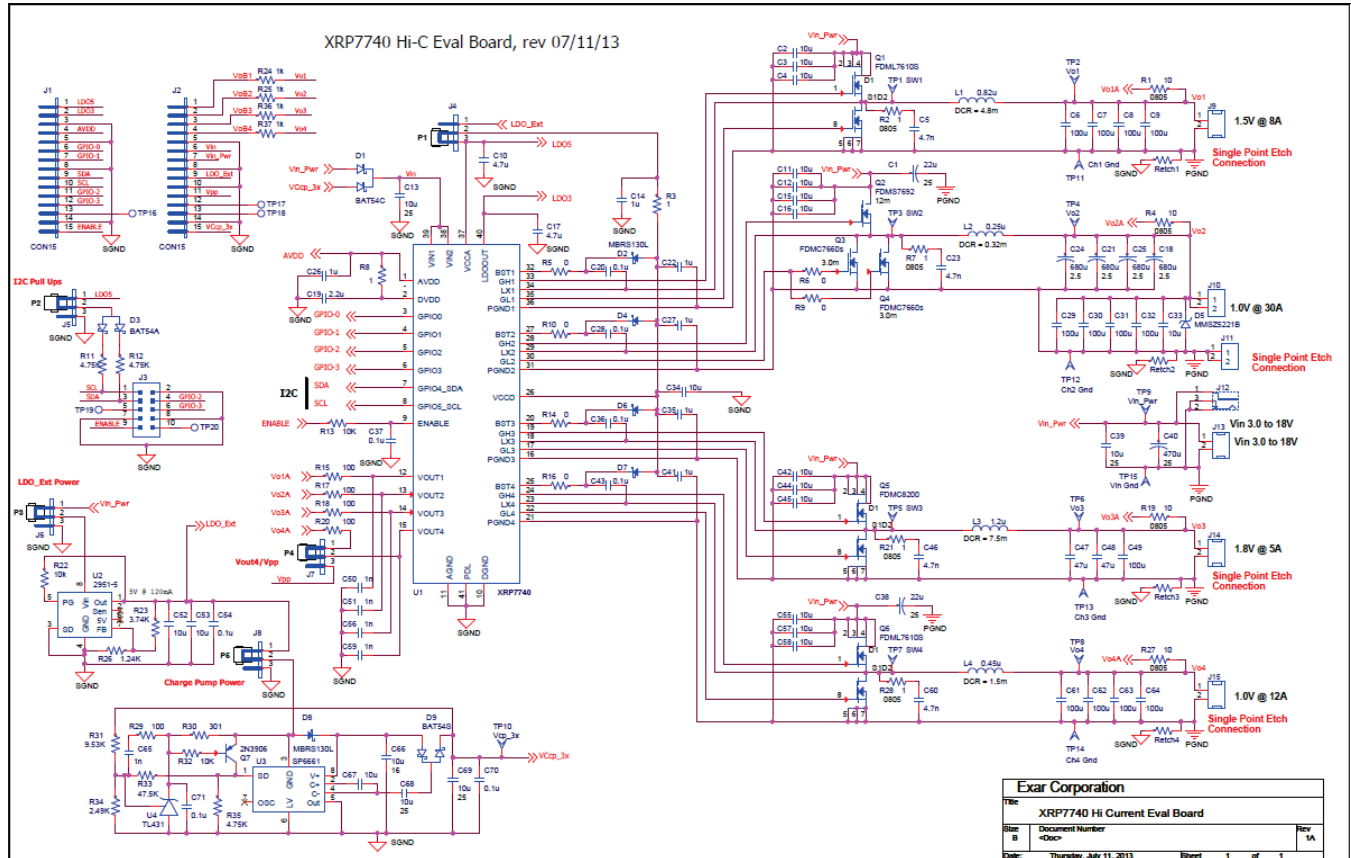

Figure 2: XRP7740EVB-HIC Schematic

**PIN ASSIGNMENT**

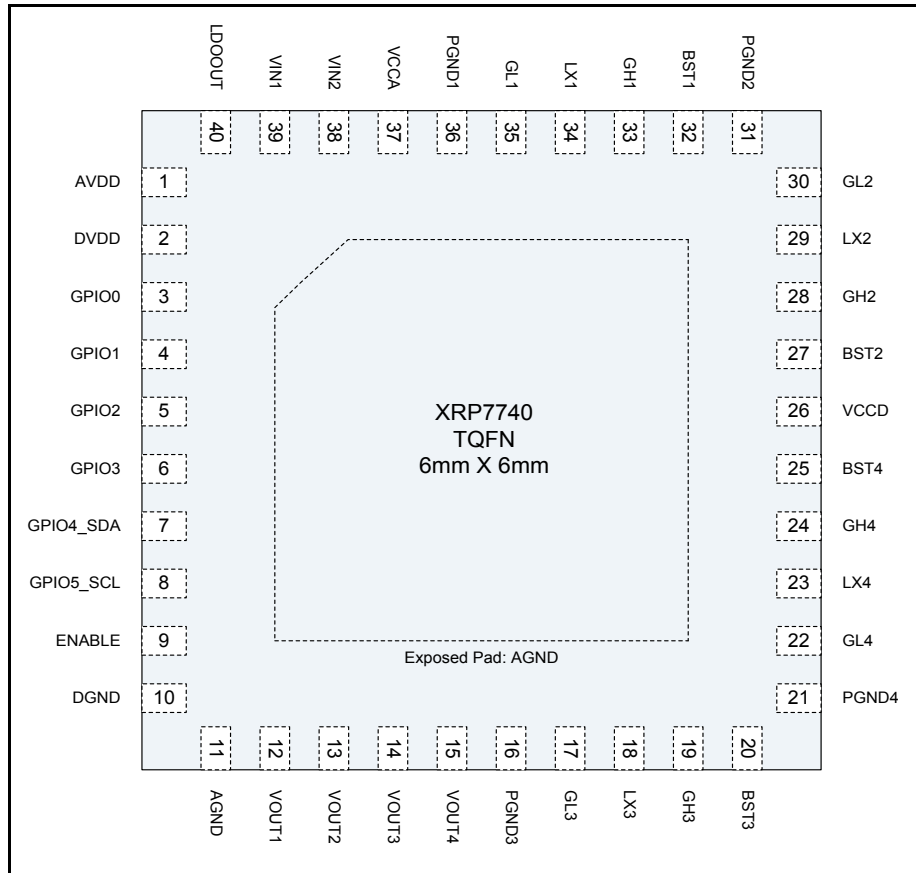

Figure 3: XRP7740 Pin Assignment

**Pin Description**

Name	Pin Number	Description
VIN1	39	Power source for the internal linear regulators to generate VCCA, VDD and the Standby LDO (LDOOUT). Place a decoupling capacitor close to the controller IC. Also used in UVLO1 fault generation – if VIN1 falls below the user programmed limit, all channels are shut down. The VIN1 pin needs to be tied to VIN2 on the board with a short trace.
VIN2	38	If the Vin2 pin voltage falls below the user programmed UVLO VIN2 level all channels are shut down. The VIN2 pin needs to be tied to VIN1 on the board with a short trace.
VCCA	37	Output of the internal 5V LDO. This voltage is internally used to power analog blocks. This pin should be bypassed with a minimum of 4.7uF to AGND
VCCD	26	Gate Drive input voltage. This is not an output voltage. This pin can be connected to VCCA to provide power for the Gate Drive. VCCD should be connected to VCCA with the shortest possible trace and decouple with a minimum 1µF capacitor. Alternatively, VCCD could be connected to an external supply (not greater than 5V).
PGND1- PGND4	36,31,16,21	GL return connection. Ground connection for the low side gate driver. Connect at low side FET source. Connecting to the ground plane at the chip will inject noise into the local ground resulting in potential I <sup>2</sup> C communications problems and PWM jitter.
AVDD	1	Output of the internal 1.8V LDO. A decoupling capacitor should be placed between AVDD and AGND close to the chip (with short traces).



A New Direction in Mixed-Signal

# XRP7740EVB-HIC

## Four Channel Digital PWM Demo Boards

Name	Pin Number	Description
DVDD	2	Input for powering the internal digital logic. This pin should be connected to AVDD.
DGND	10	Digital Ground. This pin should be connected to the ground plane at the exposed pad with a separate trace.
AGND	11	Analog Ground. This pin should be connected to the ground plane at the exposed pad with a separate trace
GL1-GL4	34,30,17,22	Output pin of the low side gate driver. Connect directly to the respective gate of an external N-channel MOSFET.
GH1-GH4	33,28,19,24	Output pin of the high side gate driver. Connect directly to the respective gate of an external N-channel MOSFET.
LX1-LX4	34,29,23,18	Lower supply rail for the high-side gate driver (GHx). Connect this pin to the switching node at the junction between the two external power MOSFETs and the inductor. These pins are also used to measure voltage drop across bottom MOSFETs in order to provide output current information to the control engine.
BST1-BST4	32,27,20,25	High side driver supply pin(s). Connect BST to an external boost diode and a capacitor as shown in the front page diagram. The high side driver is connected between the BST pin and LX pin.
GPIO0-GPIO3	3,4,5,6	These pins can be configured as inputs or outputs to implement custom flags, power good signals and enable/disable controls. A GPIO pin can also be programmed as an input clock synchronizing IC to external clock. Refer to the "GPIO Pins" Section and the "External Clock Synchronization" Section for more information.
GPIO4_SDA, GPIO5_SCL	7,8	I <sup>2</sup> C serial interface communication pins. These pins can be re-programmed to perform GPIO functions in applications when I <sup>2</sup> C bus is not used.
VOUT1-VOUT4	12,13,14,15	Voltage sense. Connect to the output of the corresponding power stage.
LDOOUT	40	Output of the Standby LDO. It can be configured as a 5V or 3.3V output. A compensation capacitor should be used on this pin [see Application Note].
ENABLE	9	If ENABLE is pulled high, the chip powers up (logic reset, registers configuration loaded, etc.). If pulled low for longer than 100us, the XRP7708/40 is placed into shutdown. See applications section for proper sequencing of this pin.
AGND	Exposed Pad	Analog Ground. Connect to analog ground (as noted above for pin 11).

### ORDERING INFORMATION

This board may be ordered from Exar as part XRP7740EVB-HIC. Refer [www.exar.com](http://www.exar.com) for exact, up to date ordering information.



A New Direction in Mixed-Signal

### USING THE EVALUATION BOARD

#### INPUT VOLTAGE CONFIGURATION

The XRP7740EVB-HIC demo board has several different input voltage options. The power components have been optimized for a 12V input rail. When running the board at an input voltage other than 12V, use PowerArchitect™ 4.xx to evaluate the system performance.

#### Single Wide Range, Input Voltage Rail

The XRP7740EVB-HIC Board ships from the factory configured for a single wide range input. The normal input voltage range is from 7.0V to 20V. With the on board charge pump enabled the input voltage range for the board is 4.5V to 20V.

#### I<sup>2</sup>C INTERFACE

The XRP77XX family of controllers employs a standard I2C interface. Pull-ups for the I2C signals are included on the demo board and may be selected by means of a configuration jumper. If using the demo board with something other than the XRP77xxEVB-XCM, verify that the SDA and SCL lines are pulled up, either by the external controller or with the on board pull ups.

#### Channel Design and Limitations

Channel 1 is designed to provide an output voltage from 0.9V to 5.0V. The default voltage is 1.5V at 8A.

Channel 2 is designed to provide an output voltage from 0.9V to 2.0V. The default voltage is 1.0V at 30A. The limiting factors are the output capacitors which has a 2.5V rating.

Channel 3 is designed to provide an output voltage from 0.9V to 5.0V. The default voltage is 1.8V at 5A.

Channel 4 is designed to provide an output voltage from .9 to 5.0V. The default voltage is 1.0V at 12A.

#### ENABLE PIN

The ENABLE pin connects to an RC network which delays turn on of the device. It is connected to J3 pin 9 of the XCM connector and J1 pin 15 with a 10K resistor and to ground through a .1uF capacitor. These pins can be used to turn on or turn off the device.

#### SPECIAL BOARD FEATURES

The board is comes from the factory wired for 7V to 20V operation. Input power can be applied either through the Power Jack, J12, or through the terminal block J13. The center lead of the J12 connector is positive.

In addition to the four XRP7740 switching power supplies. There are two other power supplies on the board. One is an external 5V LDO and the other is a charge pump tripler.

The external 5V LDO can be used to power the gate drives for the switching FETs to decrease the power dissipated by the internal chip 5V LDO.

The charge pump runs off of the on board 5V LDO and supplies a boosted voltage to the XRP7740 Vin pin to allow for operation with board input voltages down to 4.0V.

#### Configuring the Evaluation Board

The connections and test points on the board are shown in Figure 5. Please observe the correct voltage polarities for the inputs and outputs.

As you go clockwise around the edge of the board, the polarities are on the connectors are negative first and then positive for all the terminals. Also note that, again going clockwise around the board, the channels are Ch1, Ch2, Ch4, and then Ch3. This was done to match the XRP7740 pin out sequence to optimize layout of the board.

### EVALUATION BOARD CONNECTIONS:

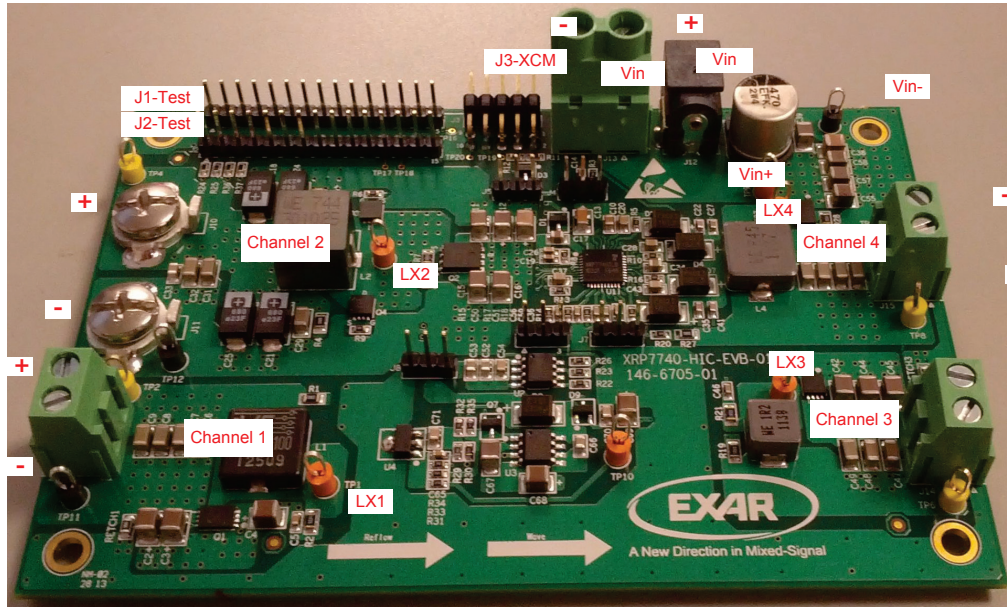

Figure 4: Board Connections

Conn.	Function	Jumper Pins to Select	
		1 - 2	2 - 3
J4	Power Source for Drivers	External 5V LDO	<b>Internal 5V LDO</b>
J5	I2C Pull Up Resistors	<b>On Board Pull Ups</b>	No Pull Ups
J6	External 5V LDO Supply	Enable Ext. 5V LDO	<b>Disable Ext. 5V LDO</b>
J7	7740 Pin 15 Connection	<b>Vo4 Output</b>	<b>Do No Use</b>
J8	Charge Pump Enable	Enable Charge Pump	<b>Disable Charge Pump</b>

### Board Jumper Configurations

There are five, three pin configuration connectors on the board. The configuration options are selected by adding a jumper to either pins 1 and 2 or pins 2 and 3.

Figure 5 shows the factory jumper positions and the above table describes the function of each of the jumpers. The items that are shown in bold are the default factory settings.

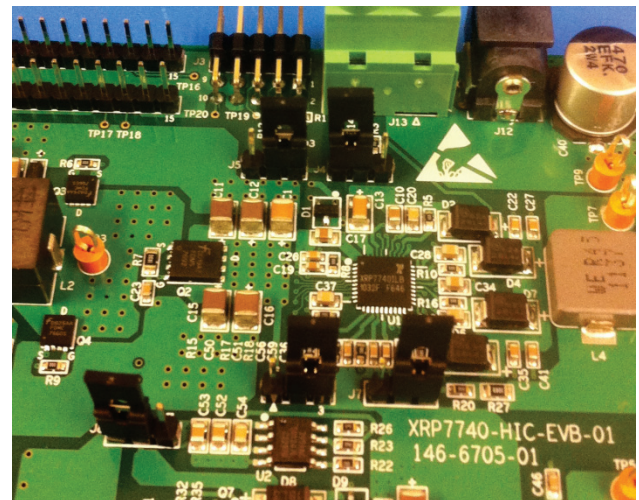

Figure 5: Factory Jumpers Setting

### Operating the Evaluation Board

Make sure that all the jumpers on the board are properly configured. For the first start up it is recommended that the default jumper settings be used.

### Bring up Procedure

Connect the flat cable from J3 on the board to XCM board. Pin 1 on J3 is next to J13 and is also marked on the board. Since the board is configured to pull up the I2C lines make sure that all jumpers on the XCM board are removed.

Connect a USB cable from the XCM board to the host computer that will be running PowerArchitect™

On the USM memory stick that came with the board is the "XRP7740 HiC, Default Config File, rev 130723.cfg" file. This is the design file that PowerArchitect™ uses to program and modify the XRP7740 device settings to configure the board to the particular application. Place this file in a directory that you can browse to later when you run PowerArchitect™

Once the above is completed run the PowerArchitect™ 4.xx software on the host computer. A configuration start-up window opens up as shown in Figure 6. Select the "Load Existing Configuration" option at the bottom of the window and browse to the directory that contains the "7740 HiC, Default Config File, rev 130723.cfg" file and select it.

This will bring you to the Overview tab of the main window.

If the XCM board is recognized, there will be an "XCM" tab. If not, "Ctrl-b" should initiate a board search and find it. Also make sure that power is applied to the board and the XCM as outlined in the XRP77XXEVB-XCM manual.

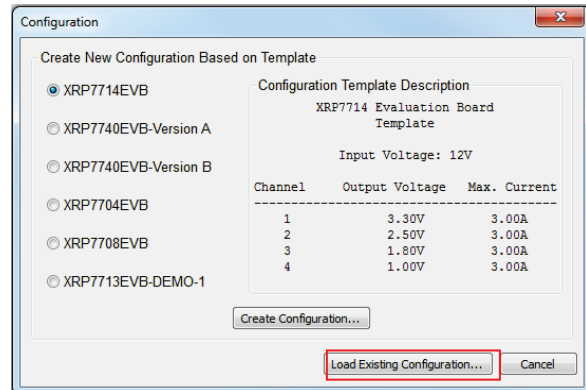

Figure 6: PowerArchitect™ Start-Up Window

Apply Power to the board. Connect the input supply by means of the power jack J12 or between the VIN pin and the GND pin of J13. Set the input voltage to 12V and turn on the Power supply. The "DEMO" page should now become live indicating communication with the XRP7740. Click "Program Chip" and a window should pop up indicating "Success".

Refer to the Exar PowerArchitect™ Quick Start Guide and release notes for information on how to run the software.

Note: PowerArchitect™ 4.21 is the current version as of the publication of this evaluation board manual. This version only allows output currents up to 20Amps to be entered. The only effect on the design is that the current limit register is set to a value that may limit the output current to below 30Amps.

A short term work around is to use the "Peek/Poke" function and write a new value into the current limit register.

To raise the Io Limit to allow for 30A operation, poke the value 0x52h into register 0x45. This is being addressed in the next revision.

Now click on the box at the middle right "Enable All".

### Evaluation Board Schematics

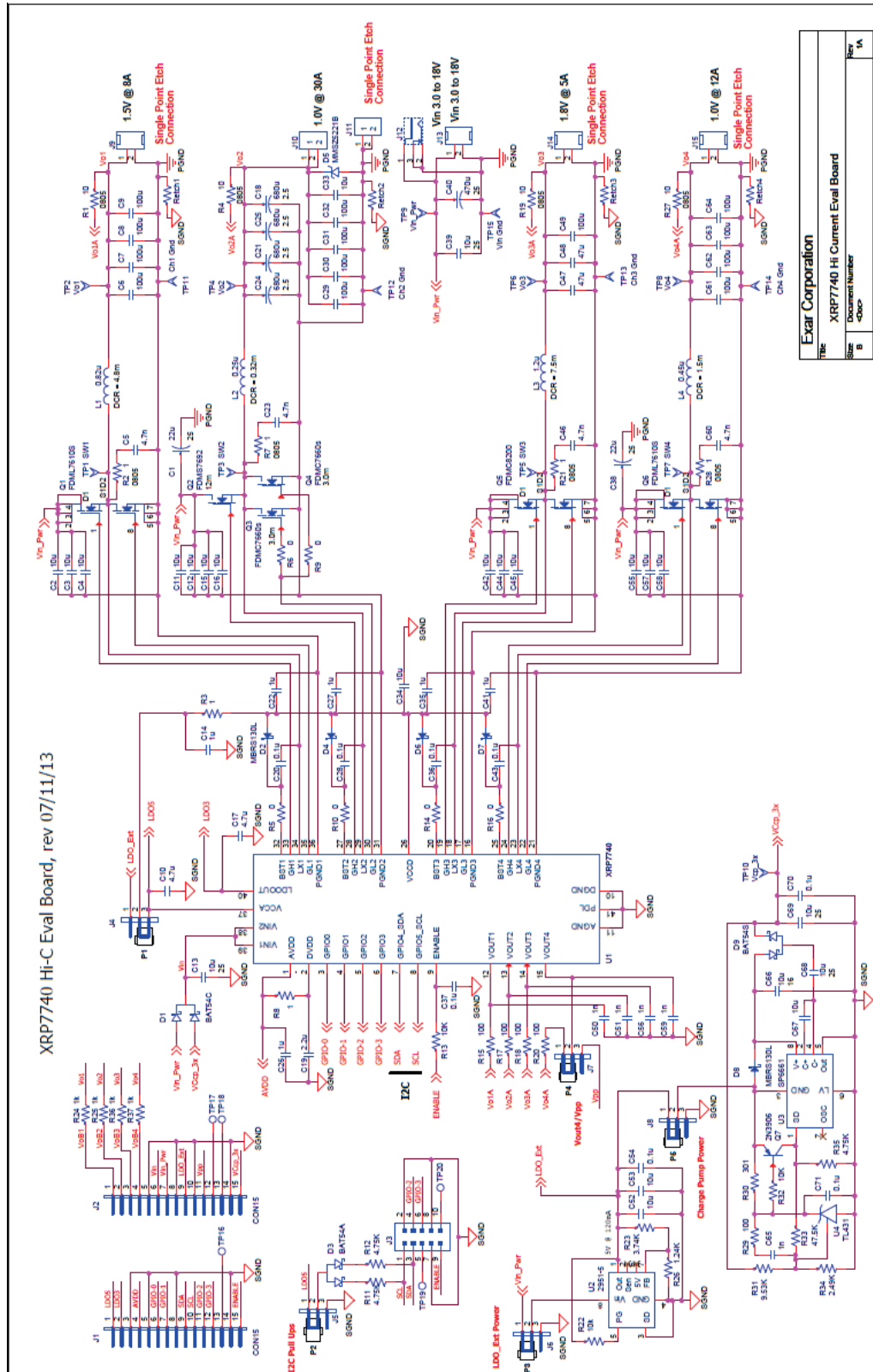

<b>Exar Corporation</b>	
Title:	XRP7740 Hi Current Eval Board
Size:	Document Number
B:	400P
Date:	Thursday, July 11, 2013
Sheet:	1 of 1
Rev:	1A

Figure 7: Board Schematic





A New Direction in Mixed-Signal

# XRP7740EVB-HIC

## Four Channel Digital PWM Demo Boards

### BILL OF MATERIAL

Ref	Qty	Part Number	Manufacturer	Size	Description
U1	1	XRP7740ILB-F	EXAR CORP.	40-PIN,6X6mm,TQFN	Quad Channel Digital PWM Step Down Controller
U2	1	SPX2951ACS-L-5-0	EXAR CORP.	8-SOIC	150mA Low Dropout Voltage Regulator
U3	1	SP6661EN-L	EXAR CORP.	NSOIC8	High Frequency 200mA Charge Pump Invert.
U4	1	SPX431LM1-L	EXAR CORP.	SOT89-3	Precision Adjustable Shunt Regulator
Q1,Q6	2	FDML7610S	FAIRCHILD	MLP 3X4.5	Dual N-Ch. PowerTrench MOSFET
Q2	1	FDMS7692	FAIRCHILD	Power56	N-Ch. powerTrench MOSFET
Q3,Q4	2	FDMC7660S	FAIRCHILD	Power 33	N-Ch. PowerTrench SyncFET
Q5,Q5	11	FDMC8200	FAIRCHILD	Power 33	Dual N-Ch. PowerTrench MOSFET
Q7	1	MMBT3906	FAIRCHILD	SOT-23	PNP General Purpose Amplifier
D1	1	BAT54C	FAIRCHILD	SOT-23	Schottky Diode
D2,D4,D6,D7,D8	5	MBRS130L	FAIRCHILD	SMB/DO-214AA	Schottky Rectifier
D3	1	BAT54A	FAIRCHILD	SOT-23	Schottky Diode
D5	1	MMSZ5221B	Diode Inc.	SOD-123	500mW SMT Zener Diode
D9	1	BAT54S	FAIRCHILD	SOT-23	Schottky Diode
L1	1	744323100	Würth Elektronik	10.6x10.6mm	WE-HCI SMD Flat Wire High Current Inductor
L2	1	744301025	Würth Elektronik	11.3x11.0mm	POWER-CHOKE WE-HCM 1190
L3	1	74437349012	Würth Elektronik	7.3x6.6mm	WE-LHMI SMD Power Inductor
L4	1	744373680045	Würth Elektronik	11x10mm	WE-LHMI SMD Power Inductor
C1,C38	2	GRM32ER71E226KE15L	Murata Corp.	1210	CAP CER 22uF, 25V, 10%, X7R
C2,C3,C4,C11,C12,C15,C16,C39,C42,C44,C45,C55,C57,C58,C67,C68,C69	17	GRM32ER7YA106KA12L	Murata Corp.	1210	CAP CER 10uF, 35V, 10%, X7R
C5,C23,C46,C60	4	GRM188R71H472KA01D	Murata Corp.	0603	CAP CER 4700pF, 50V, 10%, X7R
C6,C7,C8,C9,C29,C30,C31,C32,C49,C61,C62,C63,C64	13	GRM31CR60J107ME39L	Murata Corp.	1206	CAP CER 100uF, 6.3V, 20%, X5R
C10,C17	2	GRM21BR71C475KA73L	Murata Corp.	0'0805	CAP CER 4.7uF, 16V, 10%, X7R
C13	1	GRM31CR71E106KA12L	Murata Corp.	1206	CAP CER 10uF, 25V, 10%, X7R
C14,C22,C26,C27,C35,C41	6	GRM188R71C105KA12D	Murata Corp.	0603	CAP CER 1uF, 16V, 10%, X7R
C18,C21,C24,C25C18,C21,C24,C25	44	2R5TPF680M6L2R5TPF680M6L	Panasonic	D3LD3L	CAP POSCAP 680uF, 2.5V, 6mOhm
C19	1	GRM188R71A225KE15D	Murata Corp.	0603	CAP CER 2.2uF, 10V, 10%, X7R
C20,C28,C36,C37,C43,C54,C70,C71	8	GRM21BR71H104KA01L	Murata Corp.	0805	CAP CER 0.1uF, 50V, 10%, X7R
C33,C34,C52,C53,C66	5	GRM21BR61C106KE15L	Murata Corp.	0805	CAP CER 10uF, 16V, 10%, X5R
C40	1	EEE-FK1E471P	Panasonic	10x10.5mm	CAP ALUM 470uF, 25V, 20%, SMD
C47,C48	2	GRM31CR60J476ME19L	Murata Corp.	1206	CAP CER 47uF, 6.3V, 20%, X5R
C50,C51,C56,C59,C65	5	GRM188R71H102KA01D	Murata Corp.	0603	CAP CER 1000pF, 50V, 10%, X7R
R1,R4,R19,R27	4	CRCW0'080510R0FKEA	Vishay/Dale	0805	RES 10.0 OHM, 1/8W,1%, SMD
R2,R7,R21,R28	4	CRCW0'08051R00FKEA	Vishay/Dale	0805	RES 1.00 OHM, 1/8W, 1%, SMD
R3,R8	2	CRCW06031R00FKEA	Vishay/Dale	0603	RES 1.00 OHM, 1/10W, 1%, SMD
R5,R6,R9,R10,R14,R16	6	CRCW06030000Z0EA	Vishay/Dale	0603	RES 0.0 OHM, 1/10W,JUMP SMD



A New Direction in Mixed-Signal

# XRP7740EVB-HIC

## Four Channel Digital PWM Demo Boards

R11,R12,R35	3	CRCW060334K75FKEA	Vishay/Dale	0603	RES 4.75K OHM, 1/10W, 1%, SMD
R13,R22,R32	3	CRCW060310K0FKEA	Vishay/Dale	0603	RES 10.0K OHM, 1/10W, 1%, SMD
R24,R25,R36,R37	4	CRCW06031K00FKEA	Vishay/Dale	0603	RES 1.00K OHM, 1/10W, 1%, SMD
R15,R17,R18,R20,R29,R15,R17,R18,R20,R29	55	CRCW0603100RFKEA	Vishay/Dale	0603	RES 100 OHM, 1/10W, 1%, SMD
R23	1	CRCW06033K74FKEA	Vishay/Dale	0603	RES 3.74K OHM, 1/10W, 1%, SMD
R26	1	CRCW06031K24FKEA	Vishay/Dale	0603	RES 1.24K OHM, 1/10W, 1%, SMD
R30	1	CRCW0603301RFKEA	Vishay/Dale	0603	RES 301 OHM, 1/10W, 1%, SMD
R31	1	CRCW06039K53FKEA	Vishay/Dale	0603	RES 9.53K OHM, 1/10W, 1%, SMD
R33	1	CRCW060347K5FKEA	Vishay/Dale	0603	RES 47.5K OHM, 1/10W, 1%, SMD
R34	1	CRCW06032K49FKEA	Vishay/Dale	0603	RES 2.49K OHM, 1/10W, 1%, SMD
J12	1	RAPC722X	Switchcraft Inc.	2.1mm D, 5.5mm OD	CONN POWERJACK MINI R/A T/H
J1,J2	2	61304011121	Würth Elektronik	2.54mm	Pin Header WR-PHD, 15Pins
J3	1	61301021021	Würth Elektronik	2.54mm	THT Angled Dual Pin Header, 10Pins
J4,J5,J6,J7,J8	5	61304011121	Würth Elektronik	2.54mm	Pin Header WR-PHD, 3Pins
P1,P2,P3,P4,P5	5	609 002 115 121	Würth Elektronik	2.54mm	Pin Jumper w/Test Point
J13	1	691 218 410 002	Würth Elektronik	12.0X7.62mm	CONN. TERM. BLOCK 2POS
J9,J14,J15	3	691 216 510 002	Würth Elektronik	9.5x5.08mm	CONN. TERM. BLOCK 2POS
J10,J11	2	1202	KEYSTONE	10/32, 0.62"	Terminal Screw 10/32, .062" Brass
TP1,TP3,TP5,TP7,TP9,TP10	6	5010	KEYSTONE	0.38X0.81mm	Test Point PC Multi Purpose, RED
TP11,TP12,TP13,TP14,TP15	5	5011	KEYSTONE	0.38X0.81mm	Test Point PC Multi Purpose, BLK
TP2,TP4 TP6,TP8	4	5014	KEYSTONE	0.38X0.81mm	Test Point PC Multi Purpose, YEL



A New Direction in Mixed-Signal

# XRP7740EVB-HIC

## Four Channel Digital PWM Demo Boards

### EVALUATION BOARD LAYOUT

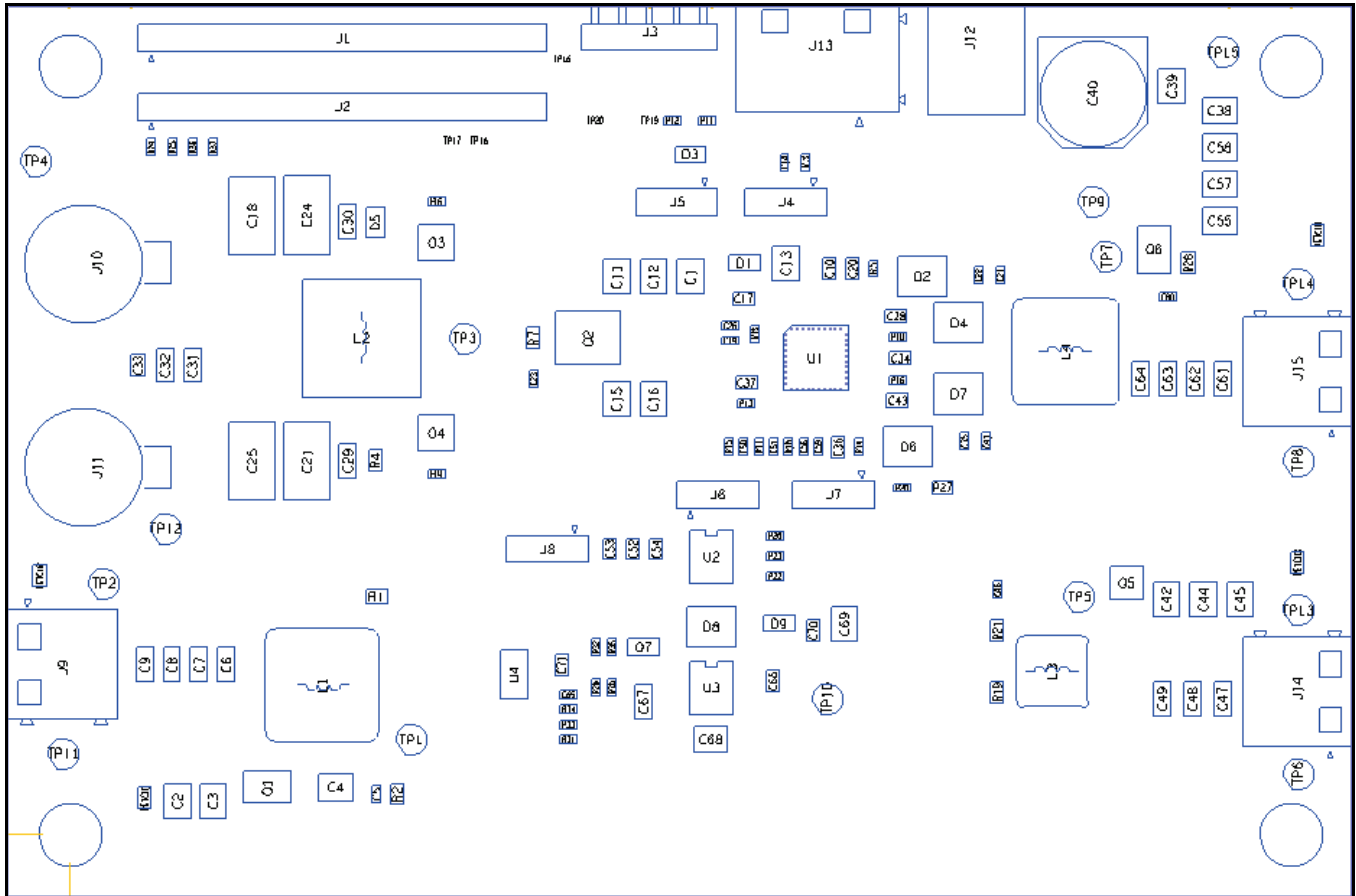

Figure 8: Layout – Components



A New Direction in Mixed-Signal

# XRP7740EVB-HIC

## Four Channel Digital PWM Demo Boards

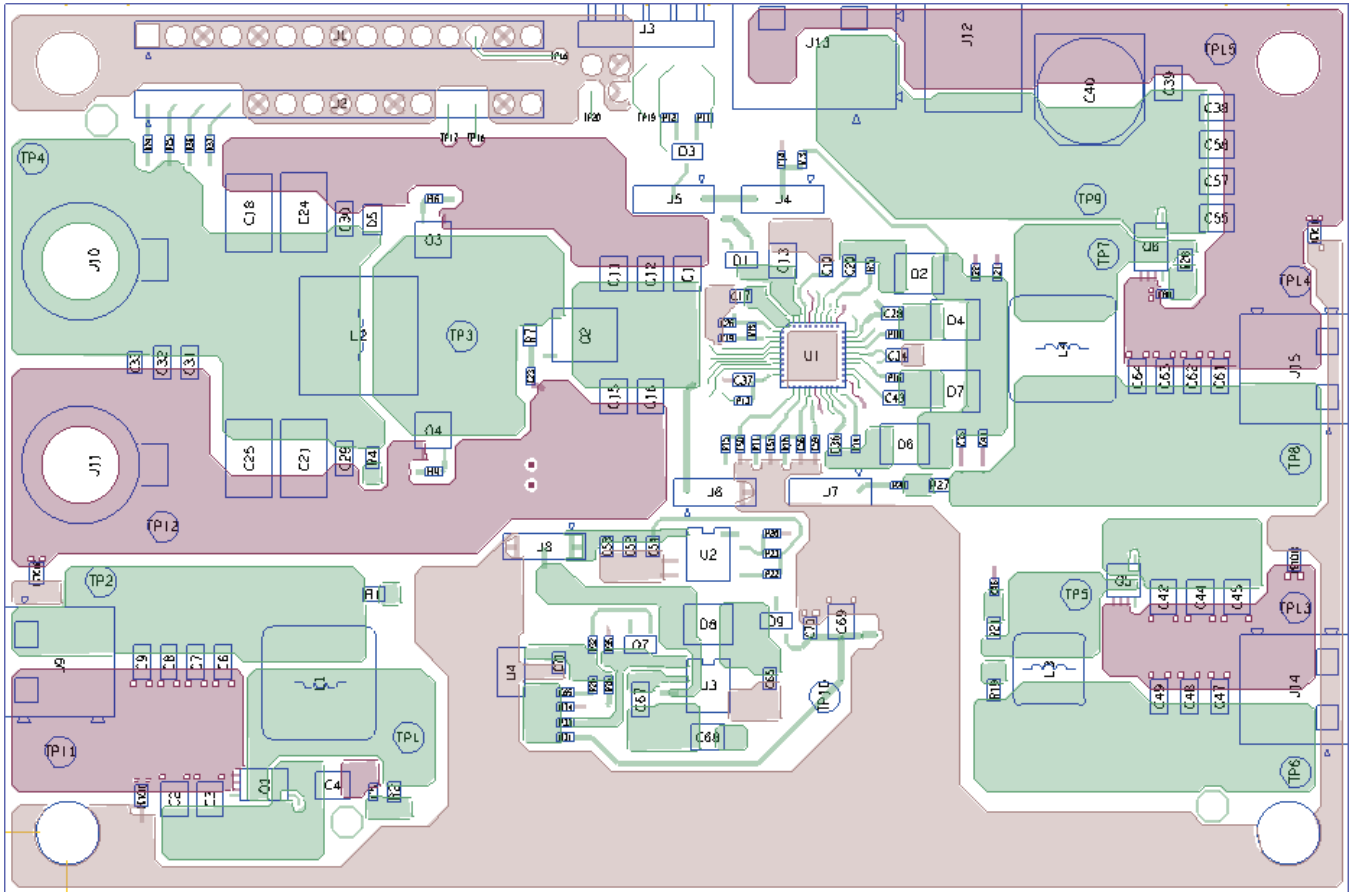

Figure 9: Layer 1, Top

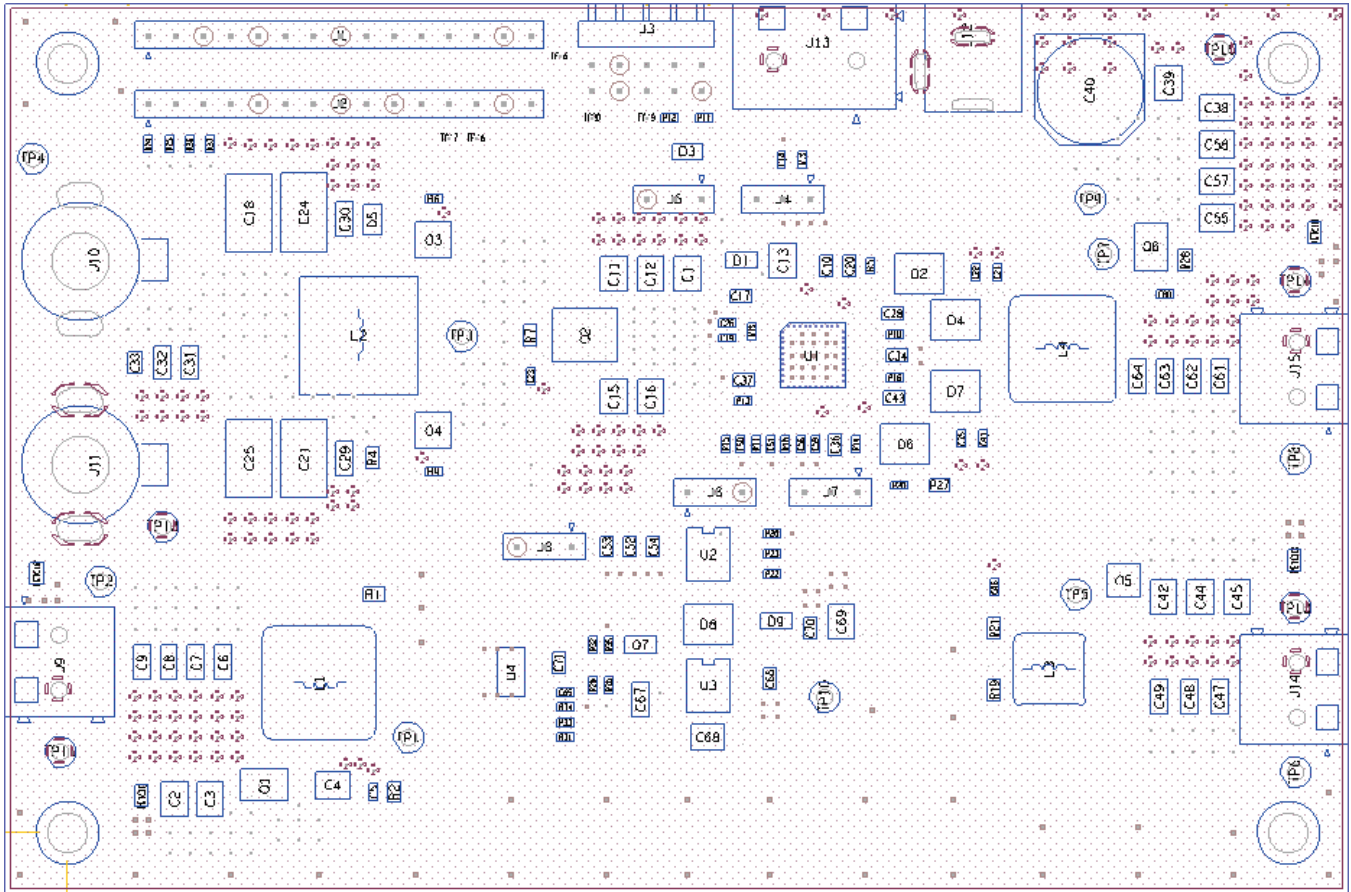

Figure 10: Layer 2, Power Ground

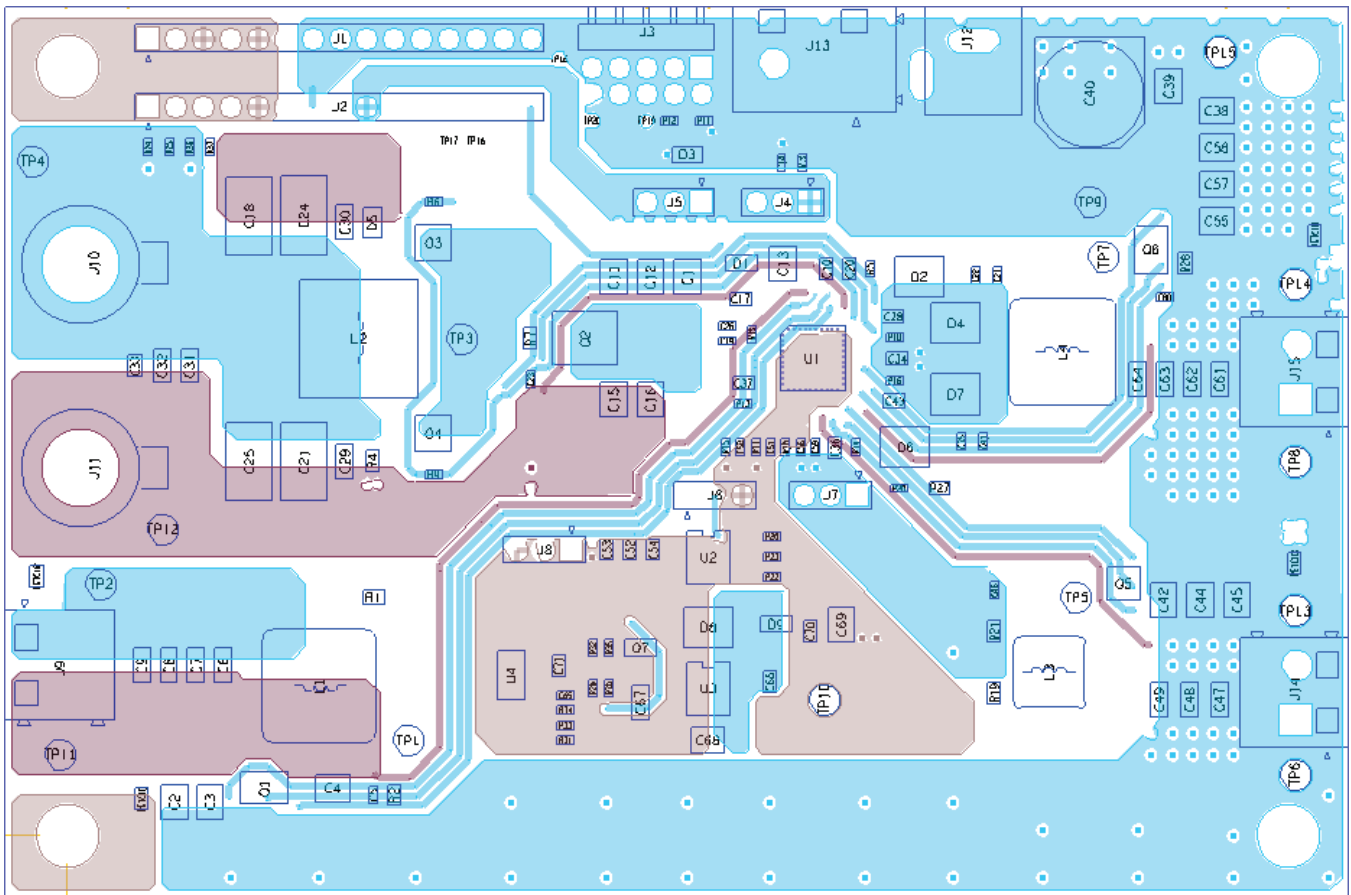

Figure 11: Layer 3, Internal

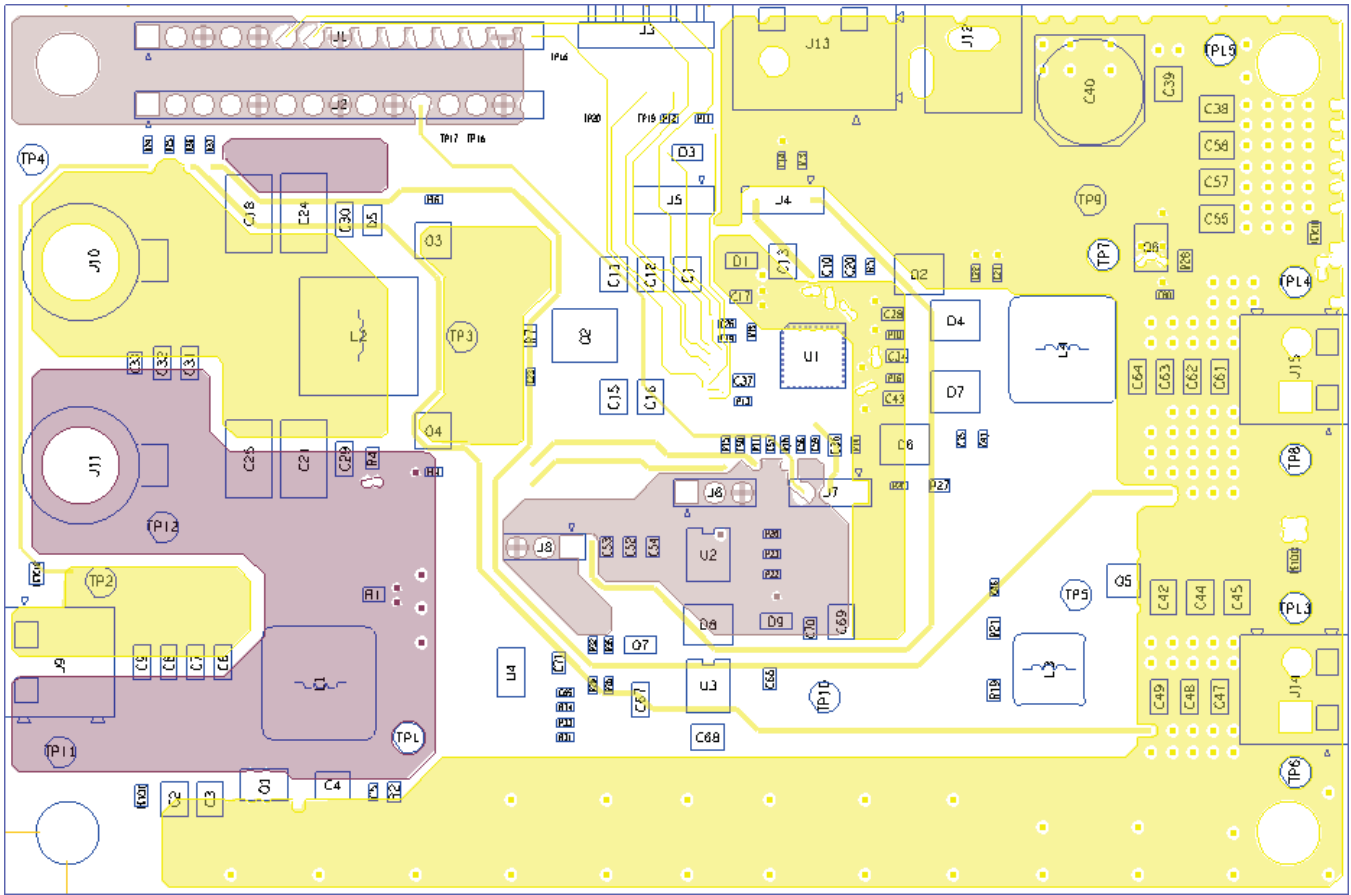

Figure 12: Layer 4, Internal

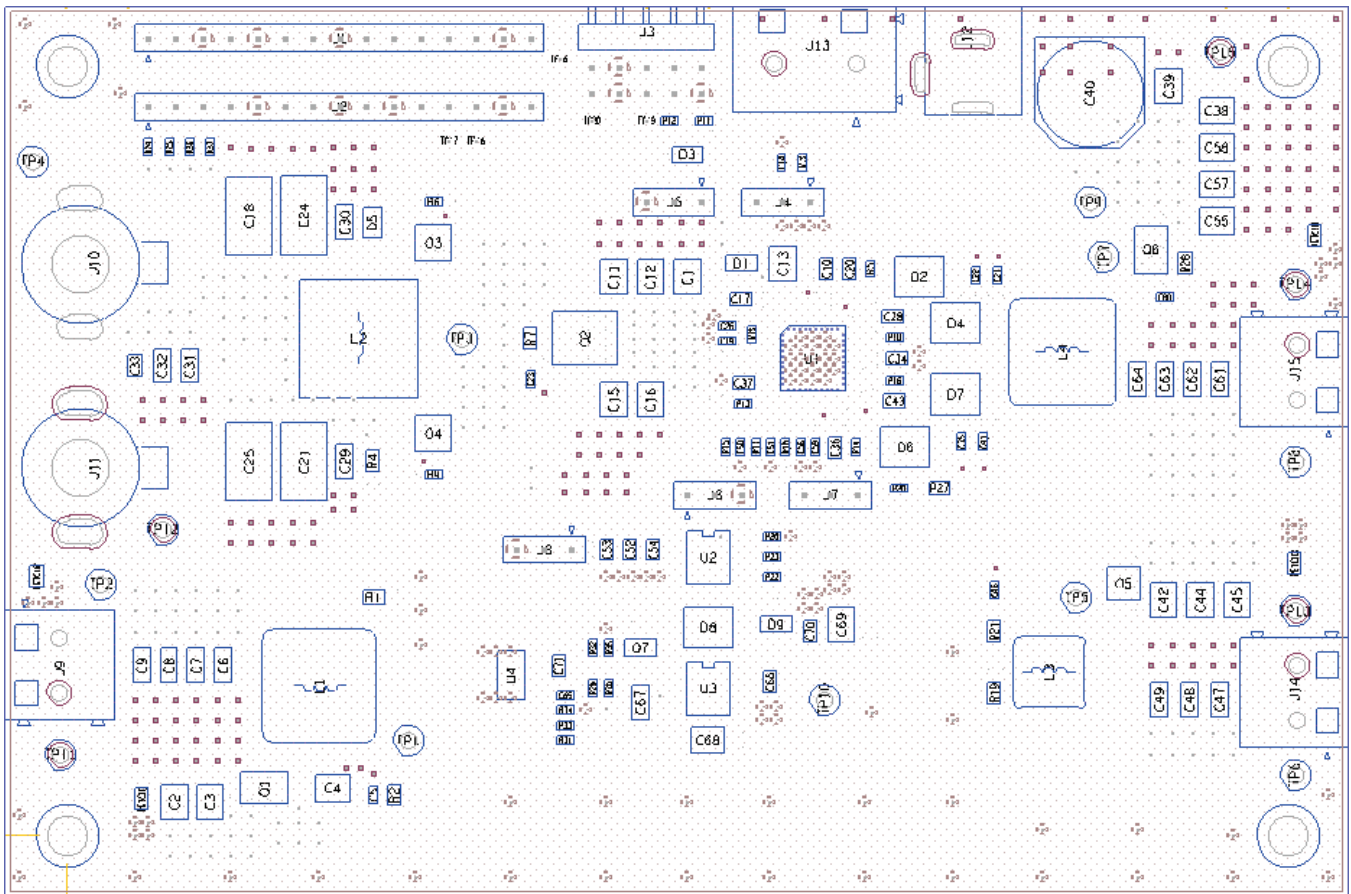

Figure 13: Layer 5, Analog Ground





A New Direction in Mixed-Signal

# XRP7740EVB-HIC

## Four Channel Digital PWM Demo Boards

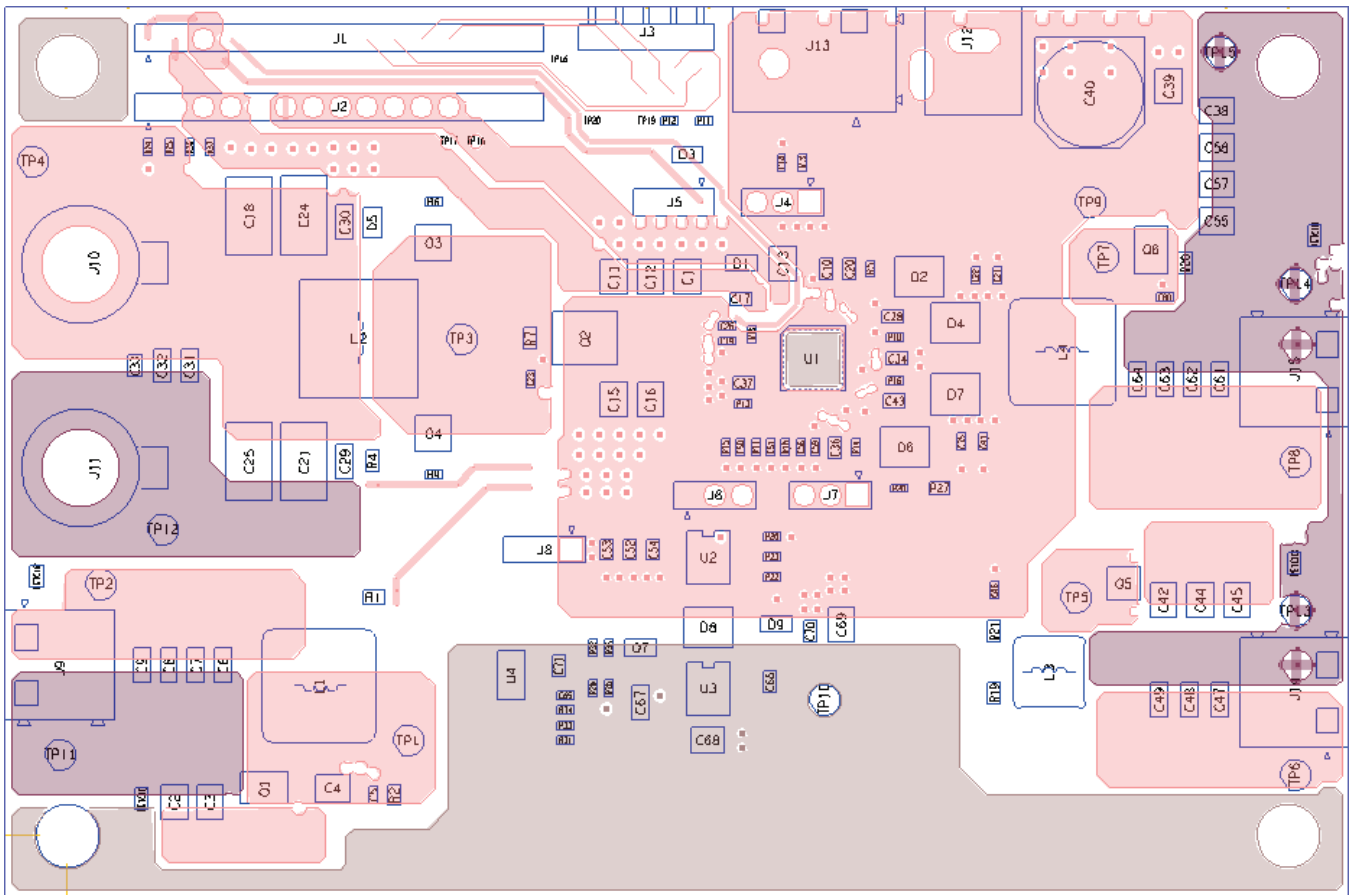

Figure 14: Layer 6, Bottom

### DOCUMENT REVISION HISTORY

Revision	Date	Description
1.0.0	07/31/13	Initial release of document

### BOARD REVISION HISTORY

Board Revision	Date	Description
REV1.0	07/31/2013	Initial release of evaluation board 7740EVB-HIC-01

### FOR FURTHER ASSISTANCE

Email: [powertechsupport@exar.com](mailto:powertechsupport@exar.com)  
[customersupport@exar.com](mailto:customersupport@exar.com)

Exar Technical Documentation: <http://www.exar.com/TechDoc/default.aspx?>



### EXAR CORPORATION

#### HEADQUARTERS AND SALES OFFICES

48720 Kato Road  
Fremont, CA 94538 – USA  
Tel.: +1 (510) 668-7000  
Fax: +1 (510) 668-7030  
[www.exar.com](http://www.exar.com)

### NOTICE

EXAR Corporation reserves the right to make changes to the products contained in this publication in order to improve design, performance or reliability. EXAR Corporation assumes no responsibility for the use of any circuits described herein, conveys no license under any patent or other right, and makes no representation that the circuits are free of patent infringement. Charts and schedules contained here in are only for illustration purposes and may vary depending upon a user's specific application. While the information in this publication has been carefully checked; no responsibility, however, is assumed for inaccuracies.

EXAR Corporation does not recommend the use of any of its products in life support applications where the failure or malfunction of the product can reasonably be expected to cause failure of the life support system or to significantly affect its safety or effectiveness. Products are not authorized for use in such applications unless EXAR Corporation receives, in writing, assurances to its satisfaction that: (a) the risk of injury or damage has been minimized; (b) the user assumes all such risks; (c) potential liability of EXAR Corporation is adequately protected under the circumstances.

Reproduction, in part or whole, without the prior written consent of EXAR Corporation is prohibited.

## Данный компонент на территории Российской Федерации

### Вы можете приобрести в компании MosChip.

Для оперативного оформления запроса Вам необходимо перейти по данной ссылке:

<http://moschip.ru/get-element>

Вы можете разместить у нас заказ для любого Вашего проекта, будь то серийное производство или разработка единичного прибора.

В нашем ассортименте представлены ведущие мировые производители активных и пассивных электронных компонентов.

Нашей специализацией является поставка электронной компонентной базы двойного назначения, продукции таких производителей как XILINX, Intel (ex.ALTERA), Vicor, Microchip, Texas Instruments, Analog Devices, Mini-Circuits, Amphenol, Glenair.

Сотрудничество с глобальными дистрибьюторами электронных компонентов, предоставляет возможность заказывать и получать с международных складов практически любой перечень компонентов в оптимальные для Вас сроки.

На всех этапах разработки и производства наши партнеры могут получить квалифицированную поддержку опытных инженеров.

Система менеджмента качества компании отвечает требованиям в соответствии с ГОСТ Р ИСО 9001, ГОСТ РВ 0015-002 и ЭС РД 009

### Офис по работе с юридическими лицами:

105318, г.Москва, ул.Щербаковская д.3, офис 1107, 1118, ДЦ «Щербаковский»

Телефон: +7 495 668-12-70 (многоканальный)

Факс: +7 495 668-12-70 (доб.304)

E-mail: [info@moschip.ru](mailto:info@moschip.ru)

Skype отдела продаж:

moschip.ru

moschip.ru\_4

moschip.ru\_6

moschip.ru\_9