

PLEASE CHECK WWW.MOLEX.COM FOR LATEST PART INFORMATION

Part Number: [0310671072](#)
Status: **Active**
Overview: [hdac 64 single row](#)
Description: 2.54mm (.100") H-DAC 64™, 3 Way Male Housing Assembly, Single-Row, Polarization C, with Xmas Tree Attachment

Documents:

[Drawing \(PDF\)](#) [Product Specification PS-31067-0001 \(PDF\)](#)
[Application Specification \(PDF\)](#) [RoHS Certificate of Compliance \(PDF\)](#)

General

Product Family Crimp Housings
 Series [31067](#)
 Comments Polarization Option C, Brown
 Overview [hdac 64 single row](#)
 Product Name H-DAC 64™

Physical

Circuits (maximum) 3
 Circuits Detail 3
 Color - Resin Brown
 Gender Male
 Glow-Wire Compliant No
 Keying to Mating Part None
 Lock to Mating Part Yes
 Material - Resin Modified Polystyrene, Polyester
 Number of Rows 1
 Packaging Type Bag
 Panel Mount No
 Pitch - Mating Interface (in) 0.100 In
 Pitch - Mating Interface (mm) 2.54 mm
 Pitch - Term. Interface (in) 0.100 In
 Pitch - Term. Interface (mm) 2.54 mm
 Polarized to Mating Part Yes
 Ports 1
 Stackable No
 Temperature Range - Operating -40°C to +100°C

Electrical

Current - Maximum per Contact 11A, 9A

Material Info

Reference - Drawing Numbers

Application Specification AS-31067-100
 Packaging Specification PK-30907-737, PK-31301-076
 Product Specification PS-31067-0001
 Sales Drawing SD-31110-003

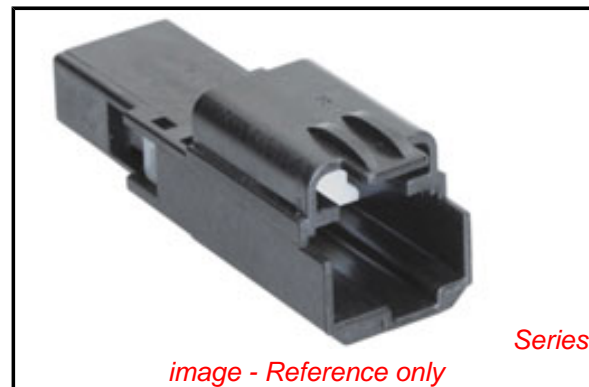

EU RoHS

ELV and RoHS Compliant
REACH SVHC
 Not Reviewed
Halogen-Free
Status
Not Reviewed

China RoHS



Need more information on product environmental compliance?

Email productcompliance@molex.com
 For a multiple part number RoHS Certificate of Compliance, [click here](#)

Please visit the [Contact Us](#) section for any non-product compliance questions.

Search Parts in this Series

[31067Series](#)

Mates With

[31101 H-DAC 64™ Vertical Header](#)

Use With

See Product Spec

3 WAY MALE HOUSING ASSEMBLY
WITHOUT XMAS TREE
(VIEWED FROM MATE SIDE)

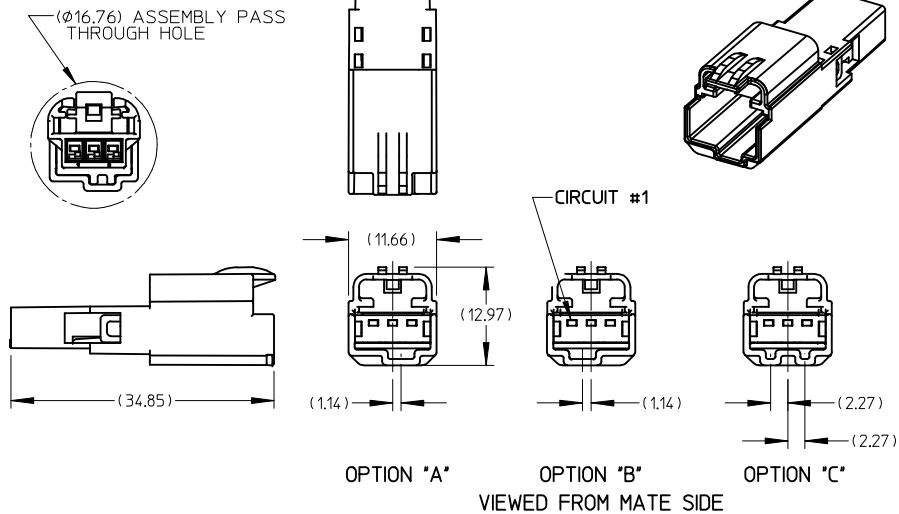

5 WAY MALE HOUSING ASSEMBLY
WITHOUT XMAS TREE
(VIEWED FROM MATE SIDE)

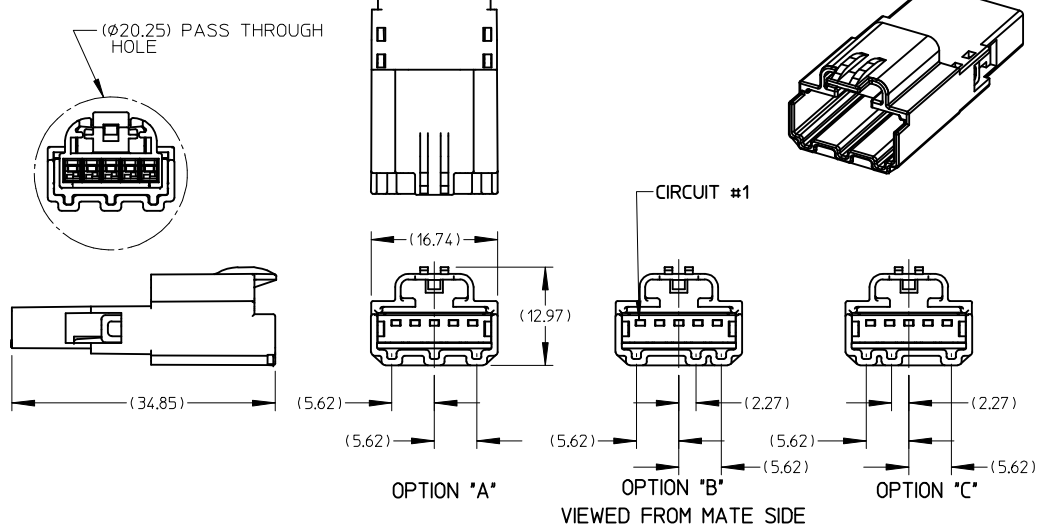

4 WAY MALE HOUSING ASSEMBLY
WITHOUT XMAS TREE
(VIEWED FROM MATE SIDE)

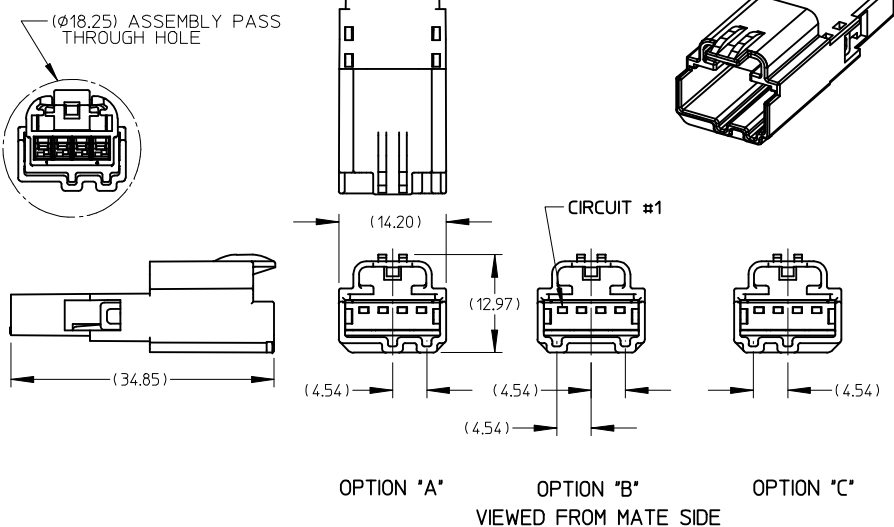

6 WAY MALE HOUSING ASSEMBLY
WITHOUT XMAS TREE
(VIEWED FROM MATE SIDE)

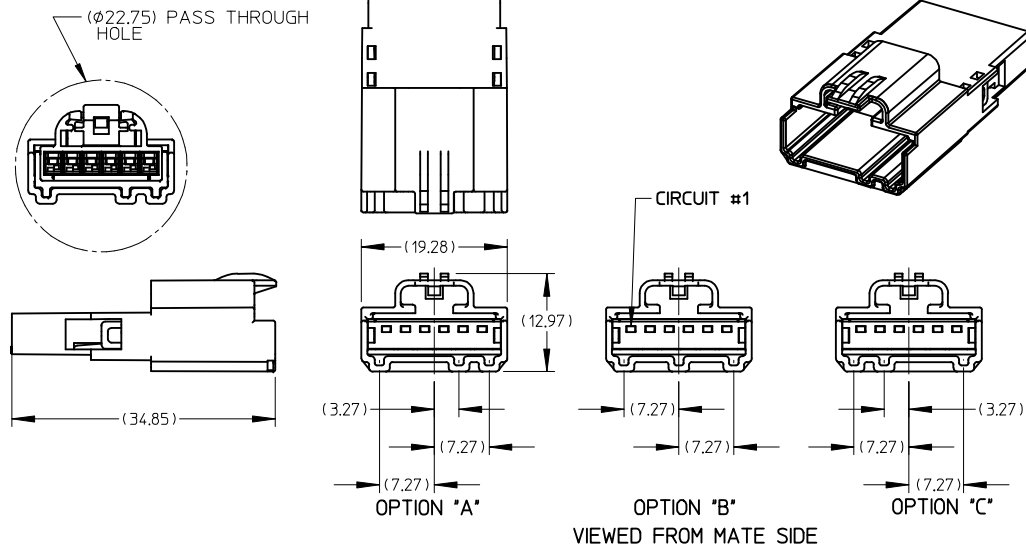

NOTES:

1. MATERIAL: HOUSING: SPS GLASS FILLED, COLOR SEE CHART.
TPA: PBT.
2. PRODUCT SPECIFICATION: PS-31067-0001.
3. PACKAGING SPECIFICATION: DRAWING PK-31301-067.
4. MATES WITH: SEE SALES DRAWINGS SD-31109-003.

EC NO: UAU2009-1155
DRWN: THERUF02009/05/12
CHK: TANGELI2009/05/14
APPR: MKNACK 2009/05/14

REV	DESCRIPTION
E1	

QUALITY SYMBOLS	GENERAL TOLERANCES (UNLESS SPECIFIED)	
	mm	INCH
▽-0	4 PLACES ± ---	± ---
	3 PLACES ± ---	± ---
	2 PLACES ± 0.13	± ---
	1 PLACE ± 0.25	± ---
∇-0	ANGULAR ± 1/2 °	

DRAFT WHERE APPLICABLE
MUST REMAIN
WITHIN DIMENSIONS

SCALE 2:1	DESIGN UNITS METRIC
DIMENSION STYLE MM ONLY	
DRAWN BY	DATE
DEMOE	01/04/04
CHECKED BY	DATE
APPROVED BY	DATE

THIRD ANGLE PROJECTION	REVISE ON CAD ONLY
MALE ASSEMBLY CHARTED SALES DRAWING	
MOLEX INCORPORATED	
MATERIAL NO. SEE CHART	DOCUMENT NO. SD-31110-003
SHEET NO. 1 OF 3	

THIS DRAWING CONTAINS INFORMATION THAT IS PROPRIETARY TO MOLEX INCORPORATED AND SHOULD NOT BE USED WITHOUT WRITTEN PERMISSION

3 WAY MALE HOUSING ASSEMBLY WITH XMAS TREE (VIEWED FROM MATE SIDE)

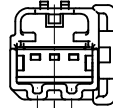
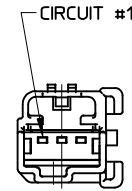
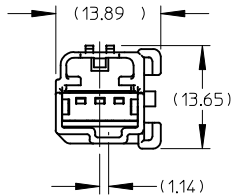
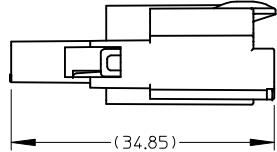
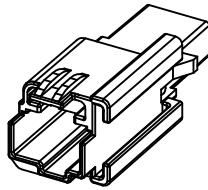
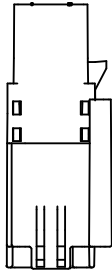

OPTION "A"

OPTION "B" VIEWED FROM MATE SIDE

OPTION "C"

5 WAY MALE HOUSING ASSEMBLY WITH XMAS TREE (VIEWED FROM MATE SIDE)

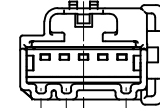
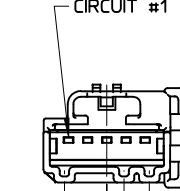
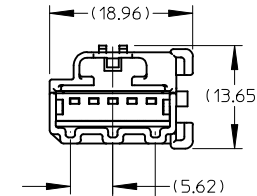
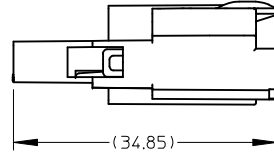
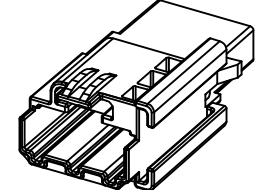
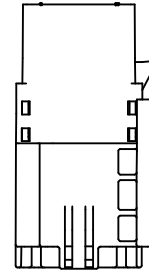

OPTION "A"

OPTION "B" VIEWED FROM MATE SIDE

OPTION "C"

4 WAY MALE HOUSING ASSEMBLY WITH XMAS TREE (VIEWED FROM MATE SIDE)

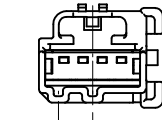
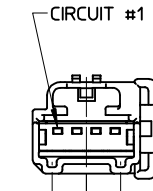
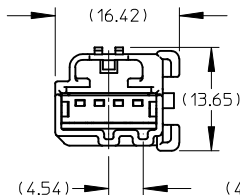
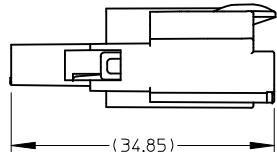
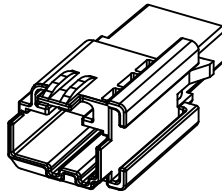
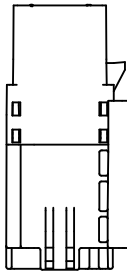

OPTION "A"

OPTION "B" VIEWED FROM MATE SIDE

OPTION "C"

6 WAY MALE HOUSING ASSEMBLY WITH XMAS TREE (VIEWED FROM MATE SIDE)

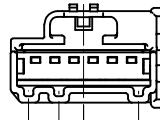
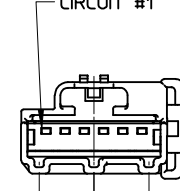
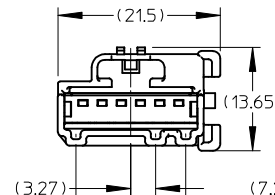
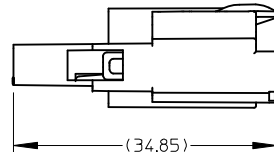
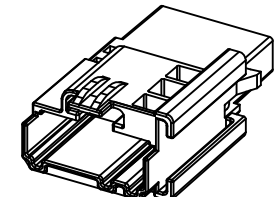
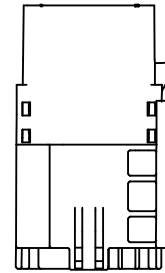

OPTION "A"

OPTION "B" VIEWED FROM MATE SIDE

OPTION "C"

EC NO: UAU2009-1155
 DRWN: THERFURT009/05/12
 CHKD: TSMITH 2009/05/14
 APPR: TANGELLO2009/05/14

REV	DESCRIPTION
E1	

QUALITY SYMBOLS	GENERAL TOLERANCES (UNLESS SPECIFIED)	
	mm	INCH
▽ = 0	4 PLACES ± .005	± .005
	3 PLACES ± .008	± .008
	2 PLACES ± 0.13	± .005
	1 PLACE ± 0.25	± .005
	ANGULAR ± 1/2°	
	DRAFT WHERE APPLICABLE MUST REMAIN WITHIN DIMENSIONS	

SCALE 2:1	DESIGN UNITS METRIC
DIMENSION STYLE MM ONLY	
DRAWN BY DEMEO	DATE 01/04/04
CHECKED BY	DATE
APPROVED BY	DATE

THIRD ANGLE PROJECTION	REVISE ON CAD ONLY
TITLE MALE ASSEMBLY CHARTED SALES DRAWING	
MOLEX MOLEX INCORPORATED	
MATERIAL NO. ENTER-PART	DOCUMENT NO. SD-31110-003
SHEET NO. 2 OF 3	
THIS DRAWING CONTAINS INFORMATION THAT IS PROPRIETARY TO MOLEX INCORPORATED AND SHOULD NOT BE USED WITHOUT WRITTEN PERMISSION	

BILL OF MATERIALS

BILL OF MATERIALS

ASSEMBLY PART NUMBER	DESCRIPTION	XMAS TREE ATTACHMENT FEATURE	PART NUMBER	DESCRIPTION	COLOR
31067-1040	3 WAY MALE ASSEMBLY POLARIZATION "A"	NO	31112-0030	MALE HOUSING	BLACK
			31114-0030	TPA	NATURAL (WHITE)
31067-1041	3 WAY MALE ASSEMBLY POLARIZATION "B"	NO	31112-0031	MALE HOUSING	GRAY
			31114-0030	TPA	NATURAL (WHITE)
31067-1042	3 WAY MALE ASSEMBLY POLARIZATION "C"	NO	31112-0032	MALE HOUSING	BROWN
			31114-0030	TPA	NATURAL (WHITE)
31067-1070	3 WAY MALE ASSEMBLY POLARIZATION "A"	YES	31112-1030	MALE HOUSING	BLACK
			31114-0030	TPA	NATURAL (WHITE)
31067-1071	3 WAY MALE ASSEMBLY POLARIZATION "B"	YES	31112-1031	MALE HOUSING	GRAY
			31114-0030	TPA	NATURAL (WHITE)
31067-1072	3 WAY MALE ASSEMBLY POLARIZATION "C"	YES	31112-1032	MALE HOUSING	BROWN
			31114-0030	TPA	NATURAL (WHITE)
31068-1040	4 WAY MALE ASSEMBLY POLARIZATION "A"	NO	31166-0040	MALE HOUSING	BLACK
			31167-0040	TPA	NATURAL (WHITE)
31068-1041	4 WAY MALE ASSEMBLY POLARIZATION "B"	NO	31166-0031	MALE HOUSING	GRAY
			31167-0040	TPA	NATURAL (WHITE)
31068-1042	4 WAY MALE ASSEMBLY POLARIZATION "C"	NO	31166-0032	MALE HOUSING	BROWN
			31167-0040	TPA	NATURAL (WHITE)
31068-1070	4 WAY MALE ASSEMBLY POLARIZATION "A"	YES	31166-1040	MALE HOUSING	BLACK
			31167-0040	TPA	NATURAL (WHITE)
31068-1071	4 WAY MALE ASSEMBLY POLARIZATION "B"	YES	31166-1041	MALE HOUSING	GRAY
			31167-0040	TPA	NATURAL (WHITE)
31068-1072	4 WAY MALE ASSEMBLY POLARIZATION "C"	YES	31166-1042	MALE HOUSING	BROWN
			31167-0040	TPA	NATURAL (WHITE)

ASSEMBLY PART NUMBER	DESCRIPTION	XMAS TREE ATTACHMENT FEATURE	PART NUMBER	DESCRIPTION	COLOR
31072-1040	5 WAY MALE ASSEMBLY POLARIZATION "A"	NO	31169-0050	MALE HOUSING	BLACK
			31170-0050	TPA	NATURAL (WHITE)
31072-1041	5 WAY MALE ASSEMBLY POLARIZATION "B"	NO	31169-0051	MALE HOUSING	GRAY
			31170-0050	TPA	NATURAL (WHITE)
31072-1042	5 WAY MALE ASSEMBLY POLARIZATION "C"	NO	31169-0052	MALE HOUSING	BROWN
			31170-0050	TPA	NATURAL (WHITE)
31072-1070	5 WAY MALE ASSEMBLY POLARIZATION "A"	YES	31169-1050	MALE HOUSING	BLACK
			31170-0050	TPA	NATURAL (WHITE)
31072-1071	5 WAY MALE ASSEMBLY POLARIZATION "B"	YES	31169-1051	MALE HOUSING	GRAY
			31170-0050	TPA	NATURAL (WHITE)
31072-1072	5 WAY MALE ASSEMBLY POLARIZATION "C"	YES	31169-1052	MALE HOUSING	BROWN
			31170-0050	TPA	NATURAL (WHITE)
31073-1040	6 WAY MALE ASSEMBLY POLARIZATION "A"	NO	31172-0060	MALE HOUSING	BLACK
			31173-0060	TPA	NATURAL (WHITE)
31073-1041	6 WAY MALE ASSEMBLY POLARIZATION "B"	NO	31172-0061	MALE HOUSING	GRAY
			31173-0060	TPA	NATURAL (WHITE)
31073-1042	6 WAY MALE ASSEMBLY POLARIZATION "C"	NO	31172-0062	MALE HOUSING	BROWN
			31173-0060	TPA	NATURAL (WHITE)
31073-1070	6 WAY MALE ASSEMBLY POLARIZATION "A"	YES	31172-1060	MALE HOUSING	BLACK
			31173-0060	TPA	NATURAL (WHITE)
31073-1071	6 WAY MALE ASSEMBLY POLARIZATION "B"	YES	31172-1061	MALE HOUSING	GRAY
			31173-0060	TPA	NATURAL (WHITE)
31073-1072	6 WAY MALE ASSEMBLY POLARIZATION "C"	YES	31172-1062	MALE HOUSING	BROWN
			31173-0060	TPA	NATURAL (WHITE)

EC NO: UAU2009-1155 DRWN: THERFU2009/05/12 CHK: TANGELL2009/05/14 APPR: MKNACK 2009/05/14	QUALITY SYMBOLS	GENERAL TOLERANCES (UNLESS SPECIFIED)		SCALE 2:1	DESIGN UNITS METRIC	THIRD ANGLE PROJECTION	REVISE ON CAD ONLY	
	▽ - 0 ∇ - 0	mm	INCH	DIMENSION STYLE		MALE ASSEMBLY CHARTED SALES DRAWING		
		MM ONLY						
		4 PLACES ± --- ± --- 3 PLACES ± --- ± --- 2 PLACES ± 0.13 ± --- 1 PLACE ± 0.25 ± --- ANGULAR ± 1/2 °	DRAWN BY DATE DEMEO 01/04/04		MOLEX INCORPORATED			
DRAFT WHERE APPLICABLE MUST REMAIN WITHIN DIMENSIONS	APPROVED BY DATE		MATERIAL NO. SEE CHART	DOCUMENT NO. SD-31110-003	SHEET NO. 3 OF 3	THIS DRAWING CONTAINS INFORMATION THAT IS PROPRIETARY TO MOLEX INCORPORATED AND SHOULD NOT BE USED WITHOUT WRITTEN PERMISSION		

Данный компонент на территории Российской Федерации

Вы можете приобрести в компании MosChip.

Для оперативного оформления запроса Вам необходимо перейти по данной ссылке:

<http://moschip.ru/get-element>

Вы можете разместить у нас заказ для любого Вашего проекта, будь то серийное производство или разработка единичного прибора.

В нашем ассортименте представлены ведущие мировые производители активных и пассивных электронных компонентов.

Нашей специализацией является поставка электронной компонентной базы двойного назначения, продукции таких производителей как XILINX, Intel (ex.ALTERA), Vicor, Microchip, Texas Instruments, Analog Devices, Mini-Circuits, Amphenol, Glenair.

Сотрудничество с глобальными дистрибьюторами электронных компонентов, предоставляет возможность заказывать и получать с международных складов практически любой перечень компонентов в оптимальные для Вас сроки.

На всех этапах разработки и производства наши партнеры могут получить квалифицированную поддержку опытных инженеров.

Система менеджмента качества компании отвечает требованиям в соответствии с ГОСТ Р ИСО 9001, ГОСТ РВ 0015-002 и ЭС РД 009

Офис по работе с юридическими лицами:

105318, г.Москва, ул.Щербаковская д.3, офис 1107, 1118, ДЦ «Щербаковский»

Телефон: +7 495 668-12-70 (многоканальный)

Факс: +7 495 668-12-70 (доб.304)

E-mail: info@moschip.ru

Skype отдела продаж:

moschip.ru

moschip.ru_4

moschip.ru_6

moschip.ru_9