



# Multichannel Remote/Local Temperature Sensors

MAX1668/MAX1805/MAX1989

## General Description

The MAX1668/MAX1805/MAX1989 are precise multi-channel digital thermometers that report the temperature of all remote sensors and their own packages. The remote sensors are diode-connected transistors—typically low-cost, easily mounted 2N3904 NPN types—that replace conventional thermistors or thermocouples. Remote accuracy is  $\pm 3^{\circ}\text{C}$  for multiple transistor manufacturers, with no calibration needed. The remote channels can also measure the die temperature of other ICs, such as microprocessors, that contain an on-chip, diode-connected transistor.

The 2-wire serial interface accepts standard system management bus (SMBus™) write byte, read byte, send byte, and receive byte commands to program the alarm thresholds and to read temperature data. The data format is 7 bits plus sign, with each bit corresponding to  $1^{\circ}\text{C}$ , in two's-complement format.

The MAX1668/MAX1805/MAX1989 are available in small, 16-pin QSOP surface-mount packages. The MAX1989 is also available in a 16-pin TSSOP.

## Applications

|                                |                                  |
|--------------------------------|----------------------------------|
| Desktop and Notebook Computers | Central-Office Telecom Equipment |
| LAN Servers                    | Test and Measurement             |
| Industrial Controls            | Multichip Modules                |

## Pin Configuration

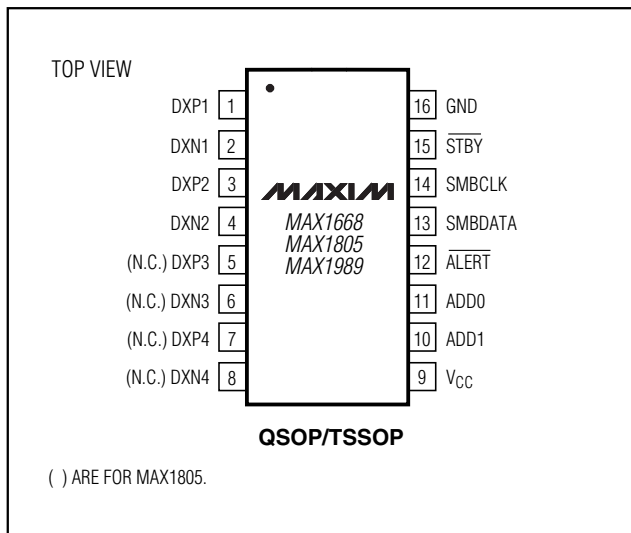

SMBus is a trademark of Intel Corp.

## Features

- ◆ Multichannel
  - 4 Remote, 1 Local (MAX1668/MAX1989)
  - 2 Remote, 1 Local (MAX1805)
- ◆ No Calibration Required
- ◆ SMBus 2-Wire Serial Interface
- ◆ Programmable Under/Overtemperature Alarms
- ◆ Supports SMBus Alert Response
- ◆ Accuracy
  - $\pm 2^{\circ}\text{C}$  ( $+60^{\circ}\text{C}$  to  $+100^{\circ}\text{C}$ , Local)
  - $\pm 3^{\circ}\text{C}$  ( $-40^{\circ}\text{C}$  to  $+125^{\circ}\text{C}$ , Local)
  - $\pm 3^{\circ}\text{C}$  ( $+60^{\circ}\text{C}$  to  $+100^{\circ}\text{C}$ , Remote)
- ◆  $3\mu\text{A}$  (typ) Standby Supply Current
- ◆  $700\mu\text{A}$  (max) Supply Current
- ◆ Small, 16-Pin QSOP/TSSOP Packages

## Ordering Information

| PART       | TEMP RANGE                                      | PIN-PACKAGE |
|------------|---|-------------|
| MAX1668MEE | $-55^{\circ}\text{C}$ to $+125^{\circ}\text{C}$ | 16 QSOP     |
| MAX1805MEE | $-55^{\circ}\text{C}$ to $+125^{\circ}\text{C}$ | 16 QSOP     |
| MAX1989MEE | $-55^{\circ}\text{C}$ to $+125^{\circ}\text{C}$ | 16 QSOP     |
| MAX1989MUE | $-55^{\circ}\text{C}$ to $+125^{\circ}\text{C}$ | 16 TSSOP    |

## Typical Operating Circuit

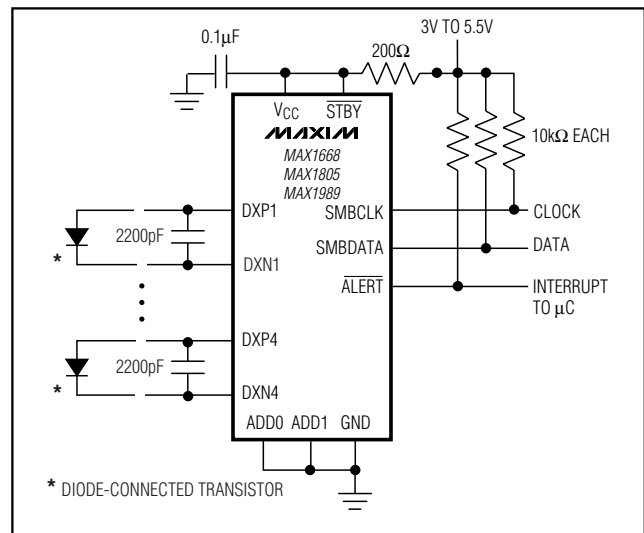

**For pricing, delivery, and ordering information, please contact Maxim/Dallas Direct! at 1-888-629-4642, or visit Maxim's website at [www.maxim-ic.com](http://www.maxim-ic.com).**

# Multichannel Remote/Local Temperature Sensors

## ABSOLUTE MAXIMUM RATINGS

|   |                                   |
|---|-----------------------------------|
| V <sub>CC</sub> to GND                                | -0.3V to +6V                      |
| DXP <sub>-</sub> , ADD <sub>-</sub> , STBY to GND     | -0.3V to (V <sub>CC</sub> + 0.3V) |
| DXN <sub>-</sub> to GND                               | -0.3V to +0.8V                    |
| SMBCLK, SMBDATA, ALERT to GND                         | -0.3V to +6V                      |
| SMBDATA, ALERT Current                                | -1mA to +50mA                     |
| DXN <sub>-</sub> Current                              | ±1mA                              |
| Continuous Power Dissipation (T <sub>A</sub> = +70°C) |                                   |
| QSOP (derate 8.30mW/°C above +70°C)                   | 667mW                             |
| TSSOP (derate 9.40mW/°C above +70°C)                  | 755mW                             |

|                                   |                 |
|-----------------------------------|-----------------|
| Operating Temperature Range       | -55°C to +125°C |
| Junction Temperature              | +150°C          |
| Storage Temperature Range         | -65°C to +150°C |
| Lead Temperature (soldering, 10s) | +300°C          |

Stresses beyond those listed under "Absolute Maximum Ratings" may cause permanent damage to the device. These are stress ratings only, and functional operation of the device at these or any other conditions beyond those indicated in the operational sections of the specifications is not implied. Exposure to absolute maximum rating conditions for extended periods may affect device reliability.

## ELECTRICAL CHARACTERISTICS

(V<sub>CC</sub> = +3.3V,  $\overline{\text{STBY}}$  = V<sub>CC</sub>, configuration byte = X0XXXX00, T<sub>A</sub> = 0°C to +125°C, unless otherwise noted.)

| PARAMETER                                       | CONDITIONS   |   | MIN  | TYP | MAX  | UNITS |
|---|--|---|------|-----|------|-------|
| <b>ADC AND POWER SUPPLY</b>                     |  |   |      |     |      |       |
| Temperature Resolution (Note 1)                 | Monotonicity guaranteed  |   | 8    |     |      | Bits  |
| Initial Temperature Error, Local Diode (Note 2) | T <sub>A</sub> = +60°C to +100°C                                     |   | -2   |     | +2   | °C    |
|   | T <sub>A</sub> = 0°C to +125°C                                       |   | -3   |     | +3   |       |
| Temperature Error, Remote Diode (Notes 2, 3)    | T <sub>R</sub> = +60°C to +100°C                                     |   | -3   |     | +3   | °C    |
|   | T <sub>R</sub> = -55°C to +125°C                                     |   | -5   |     | +5   |       |
| Temperature Error, Local Diode (Notes 1, 2)     | Including long-term drift  | T <sub>A</sub> = +60°C to +100°C              | -2.5 |     | +2.5 | °C    |
|   |  | T <sub>A</sub> = 0°C to +85°C                 | -3.5 |     | +3.5 |       |
| Supply Voltage Range                            |  |   | 3.0  |     | 5.5  | V     |
| Undervoltage Lockout Threshold                  | V <sub>CC</sub> input, disables A/D conversion, rising edge          |   | 2.60 | 2.8 | 2.95 | V     |
| Undervoltage Lockout Hysteresis                 |  |   |      | 50  |      | mV    |
| Power-On Reset (POR) Threshold                  | V <sub>CC</sub> , falling edge                                       |   | 1.3  | 1.8 | 2.3  | V     |
| POR Threshold Hysteresis                        |  |   |      | 50  |      | mV    |
| Standby Supply Current                          | Logic inputs forced to V <sub>CC</sub> or GND                        | SMBus static                                  |      | 3   | 10   | μA    |
|   |  | Hardware or software standby, SMBCLK at 10kHz |      | 5   | 12   |       |
| Average Operating Supply Current                | Average measured over 4s; logic inputs forced V <sub>CC</sub> or GND |   |      | 400 | 700  | μA    |
| Conversion Time                                 | From stop bit to conversion complete (all channels)                  |   | 260  | 320 | 380  | ms    |
| Remote-Diode Source Current                     | DXP <sub>-</sub> forced to 1.5V                                      | High level (POR state)                        | 70   | 100 | 130  | μA    |
|   |  | Low level (POR state)                         | 7    | 10  | 13   |       |
|   |  | Configuration byte = X0XXXX10, high level     |      | 200 |      |       |
|   |  | Configuration byte = X0XXXX01, high level     |      | 50  |      |       |
| DXN <sub>-</sub> Source Voltage                 |  |   |      | 0.7 |      | V     |
| Address Pin Bias Current                        | ADD0, ADD1; momentary upon power-on reset                            |   |      | 160 |      | μA    |

# Multichannel Remote/Local Temperature Sensors

MAX1668/MAX1805/MAX1989

## ELECTRICAL CHARACTERISTICS (continued)

( $V_{CC} = +3.3V$ ,  $\overline{STBY} = V_{CC}$ , configuration byte = X0XXXX00,  $T_A = 0^{\circ}C$  to  $+125^{\circ}C$ , unless otherwise noted.)

| PARAMETER                                      | CONDITIONS   | MIN | TYP | MAX | UNITS   |
|--|--|-----|-----|-----|---------|
| <b>SMBus INTERFACE</b>                         |  |     |     |     |         |
| Logic Input High Voltage                       | $\overline{STBY}$ , SMBCLK, SMBDATA; $V_{CC} = 3V$ to $5.5V$ | 2.2 |     |     | V       |
| Logic Input Low Voltage                        | $\overline{STBY}$ , SMBCLK, SMBDATA; $V_{CC} = 3V$ to $5.5V$ |     |     | 0.8 | V       |
| Logic Output Low Sink Current                  | $\overline{ALERT}$ , SMBDATA forced to $0.4V$                | 6   |     |     | mA      |
| $\overline{ALERT}$ Output High Leakage Current | $\overline{ALERT}$ forced to $5.5V$                          |     |     | 1   | $\mu A$ |
| Logic Input Current                            | Logic inputs forced to $V_{CC}$ or GND                       | -1  |     | +1  | $\mu A$ |
| SMBus Input Capacitance                        | SMBCLK, SMBDATA  |     | 5   |     | pF      |
| SMBus Clock Frequency                          | (Note 4)   | DC  |     | 100 | kHz     |
| SMBCLK Clock Low Time                          | $t_{LOW}$ , 10% to 10% points                                | 4.7 |     |     | $\mu s$ |
| SMBCLK Clock High Time                         | $t_{HIGH}$ , 90% to 90% points                               | 4   |     |     | $\mu s$ |
| SMBus Start-Condition Setup Time               |  | 4.7 |     |     | $\mu s$ |
| SMBus Repeated Start-Condition Setup Time      | $t_{SU:STA}$ , 90% to 90% points                             | 250 |     |     | ns      |
| SMBus Start-Condition Hold Time                | $t_{HD:STA}$ , 10% of SMBDATA to 90% of SMBCLK               | 4   |     |     | $\mu s$ |
| SMBus Stop-Condition Setup Time                | $t_{SU:STO}$ , 90% of SMBCLK to 10% of SMBDATA               | 4   |     |     | $\mu s$ |
| SMBus Data Valid to SMBCLK Rising-Edge Time    | $t_{SU:DAT}$ , 10% or 90% of SMBDATA to 10% of SMBCLK        | 250 |     |     | ns      |
| SMBus Data-Hold Time                           | $t_{HD:DAT}$ , slave receive (Note 5)                        | 0   |     |     | ns      |
| SMBCLK Falling Edge to SMBus Data-Valid Time   | Master clocking in data                                      |     |     | 1   | $\mu s$ |

## ELECTRICAL CHARACTERISTICS

( $V_{CC} = +5V$ ,  $\overline{STBY} = V_{CC}$ , configuration byte = X0XXXX00,  $T_A = -55^{\circ}C$  to  $+125^{\circ}C$ , unless otherwise noted.) (Note 6)

| PARAMETER                                       | CONDITIONS   | MIN | TYP | MAX | UNITS       |
|---|--|-----|-----|-----|-------------|
| <b>ADC AND POWER SUPPLY</b>                     |  |     |     |     |             |
| Temperature Resolution                          | Monotonicity guaranteed                              | 8   |     |     | Bits        |
| Initial Temperature Error, Local Diode (Note 2) | $T_A = +60^{\circ}C$ to $+100^{\circ}C$              | -2  |     | +2  | $^{\circ}C$ |
|   | $T_A = -55^{\circ}C$ to $+125^{\circ}C$              | -3  |     | +3  |             |
| Temperature Error, Remote Diode (Notes 2, 3)    | $T_R = +60^{\circ}C$ to $+100^{\circ}C$              | -3  |     | +3  | $^{\circ}C$ |
|   | $T_R = -55^{\circ}C$ to $+125^{\circ}C$              | -5  |     | +5  |             |
| Supply-Voltage Range                            |  | 4.5 |     | 5.5 | V           |
| Conversion Time                                 | From stop bit to conversion complete (both channels) | 260 |     | 380 | ms          |

# Multichannel Remote/Local Temperature Sensors

## ELECTRICAL CHARACTERISTICS (continued)

( $V_{CC} = +5V$ ,  $\overline{STBY} = V_{CC}$ , configuration byte = X0XXXX00,  $T_A = -55^{\circ}C$  to  $+125^{\circ}C$ , unless otherwise noted.) (Note 6)

| PARAMETER                                      | CONDITIONS   | MIN | TYP | MAX | UNITS   |
|--|--|-----|-----|-----|---------|
| <b>SMBus INTERFACE</b>                         |  |     |     |     |         |
| Logic Input High Voltage                       | $\overline{STBY}$ , SMBCLK, SMBDATA; $V_{CC} = 4.5V$ to $5.5V$ | 2.4 |     |     | V       |
| Logic Input Low Voltage                        | $\overline{STBY}$ , SMBCLK, SMBDATA; $V_{CC} = 4.5V$ to $5.5V$ |     |     | 0.8 | V       |
| Logic Output Low Sink Current                  | $\overline{ALERT}$ , SMBDATA forced to $0.4V$                  | 6   |     |     | mA      |
| $\overline{ALERT}$ Output High Leakage Current | $\overline{ALERT}$ forced to $5.5V$                            |     |     | 1   | $\mu A$ |
| Logic Input Current                            | Logic inputs forced to $V_{CC}$ or GND                         | -2  |     | +2  | $\mu A$ |

**Note 1:** Guaranteed by design, but not production tested.

**Note 2:** Quantization error is not included in specifications for temperature accuracy. For example, if the MAX1668/MAX1805/MAX1989 device temperature is exactly  $+66.7^{\circ}C$ , the ADC may report  $+66^{\circ}C$ ,  $+67^{\circ}C$ , or  $+68^{\circ}C$  (due to the quantization error plus the  $+0.5^{\circ}C$  offset used for rounding up) and still be within the guaranteed  $\pm 1^{\circ}C$  error limits for the  $+60^{\circ}C$  to  $+100^{\circ}C$  temperature range. See Table 2.

**Note 3:** A remote diode is any diode-connected transistor from Table 1.  $T_R$  is the junction temperature of the remote diode. See the *Remote-Diode Selection* section for remote-diode forward-voltage requirements.

**Note 4:** The SMBus logic block is a static design that works with clock frequencies down to DC. While slow operation is possible, it violates the 10kHz minimum clock frequency and SMBus specifications, and can monopolize the bus.

**Note 5:** Note that a transition must internally provide at least a hold time in order to bridge the undefined region (300ns max) of SMBCLK's falling edge  $t_{HD:DAT}$ .

**Note 6:** Specifications from  $-55^{\circ}C$  to  $+125^{\circ}C$  are guaranteed by design, not production tested.

## Typical Operating Characteristics

(Typical Operating Circuit,  $V_{CC} = +5V$ ,  $\overline{STBY} = V_{CC}$ , configuration byte = X0XXXX00,  $T_A = +25^{\circ}C$ , unless otherwise noted.)

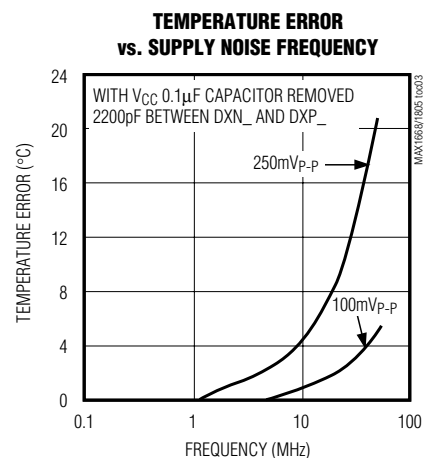
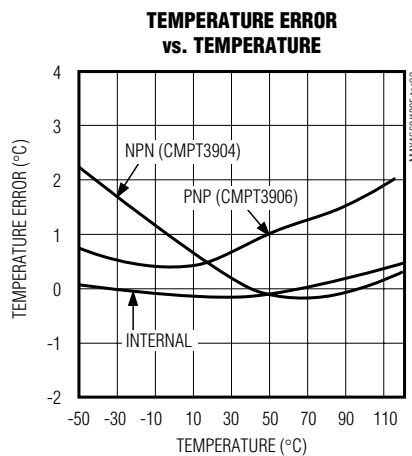
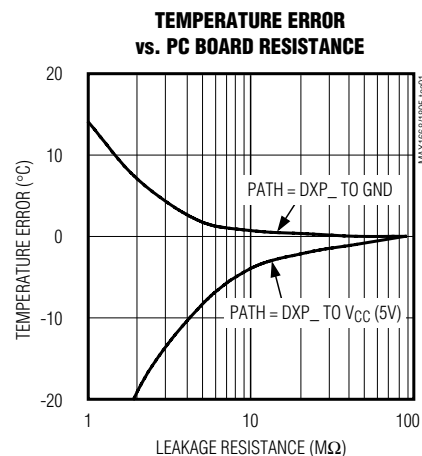

# Multichannel Remote/Local Temperature Sensors

## Typical Operating Characteristics (continued)

(Typical Operating Circuit,  $V_{CC} = +5V$ ,  $STBY = V_{CC}$ , configuration byte = X0XXXX00,  $T_A = +25^\circ C$ , unless otherwise noted.)

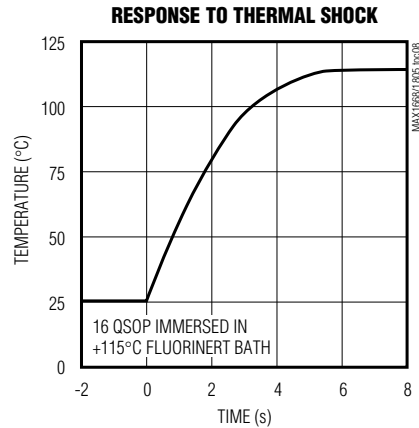
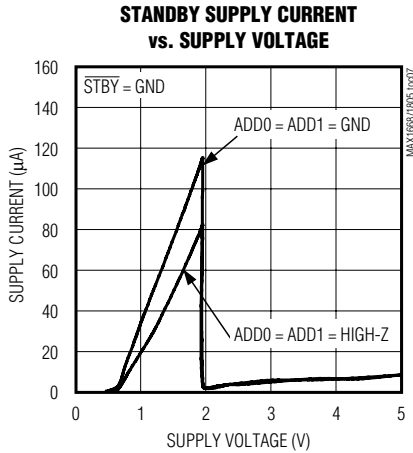
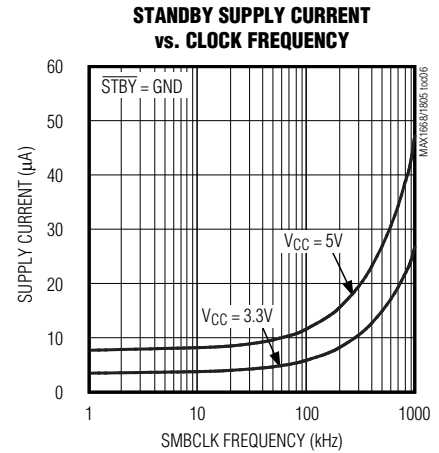
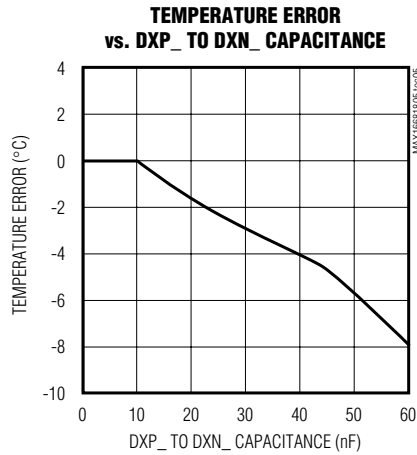
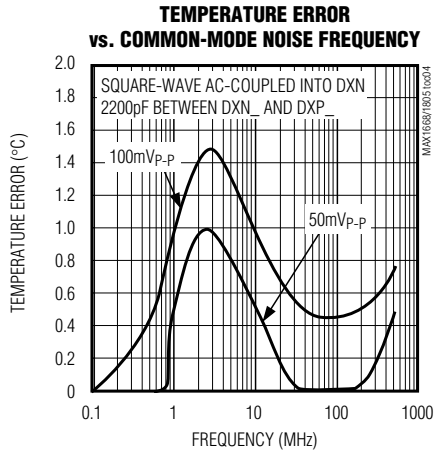

MAX1668/MAX1805/MAX1989

# Multichannel Remote/Local Temperature Sensors

## Pin Description

| PIN                 |         |                 | FUNCTION   |
|---------------------|---------|-----------------|--|
| MAX1668/<br>MAX1989 | MAX1805 | NAME            |  |
| 1, 3, 5, 7          | 1, 3    | DXP_            | Combined Current Source and A/D Positive Input for Remote-Diode Channel. Do not leave DXP floating; connect DXP to DXN if no remote diode is used. Place a 2200pF capacitor between DXP and DXN for noise filtering. |
| 2, 4, 6, 8          | 2, 4    | DXN_            | Combined Current Sink and A/D Negative Input. DXN is normally biased to a diode voltage above ground.  |
| 9                   | 9       | V <sub>CC</sub> | Supply Voltage Input, 3V to 5.5V. Bypass to GND with a 0.1μF capacitor. A 200Ω series resistor is recommended but not required for additional noise filtering.   |
| 10                  | 10      | ADD1            | SMBus Address Select Pin (Table 8). ADD0 and ADD1 are sampled upon power-up. Excess capacitance (>50pF) at the address pins when floating can cause address-recognition problems.                                    |
| 11                  | 11      | ADD0            | SMBus Slave Address Select Pin   |
| 12                  | 12      | ALERT           | SMBus Alert (Interrupt) Output, Open Drain   |
| 13                  | 13      | SMBDATA         | SMBus Serial-Data Input/Output, Open Drain   |
| 14                  | 14      | SMBCLK          | SMBus Serial-Clock Input   |
| 15                  | 15      | STBY            | Hardware Standby Input. Temperature and comparison threshold data are retained in standby mode. Low = standby mode, high = operate mode.   |
| 16                  | 16      | GND             | Ground   |
| —                   | 5–8     | N.C.            | No Connection. Not internally connected. Can be used for PC board trace routing.   |

## Detailed Description

The MAX1668/MAX1805/MAX1989 are temperature sensors designed to work in conjunction with an external microcontroller (μC) or other intelligence in thermostatic, process-control, or monitoring applications. The μC is typically a power-management or keyboard controller, generating SMBus serial commands by “bit-banging” general-purpose input-output (GPIO) pins or through a dedicated SMBus interface block.

These devices are essentially 8-bit serial analog-to-digital converters (ADCs) with sophisticated front ends. However, the MAX1668/MAX1805/MAX1989 also contain a switched current source, a multiplexer, an ADC, an SMBus interface, and associated control logic (Figure 1). In the MAX1668 and MAX1989, temperature data from the ADC is loaded into five data registers, where it is automatically compared with data previously stored in 10 over/undertemperature alarm registers. In the MAX1805, temperature data from the ADC is loaded into three data registers, where it is automatically compared with data previously stored in six over/undertemperature alarm registers.

## ADC and Multiplexer

The ADC is an averaging type that integrates over a 64ms period (each channel, typical), with excellent noise rejection.

The multiplexer automatically steers bias currents through the remote and local diodes, measures their forward voltages, and computes their temperatures. Each channel is automatically converted once the conversion process has started. If any one of the channels is not used, the device still performs measurements on these channels, and the user can ignore the results of the unused channel. If any remote-diode channel is unused, connect DXP\_ to DXN\_ rather than leaving the pins open.

The DXN\_ input is biased at 0.65V above ground by an internal diode to set up the A/D inputs for a differential measurement. The worst-case DXP\_ to DXN\_ differential input voltage range is 0.25V to 0.95V.

Excess resistance in series with the remote diode causes about +0.5°C error per ohm. Likewise, 200μV of offset voltage forced on DXP\_ to DXN\_ causes about 1°C error.

# Multichannel Remote/Local Temperature Sensors

**MAX1668/MAX1805/MAX1989**

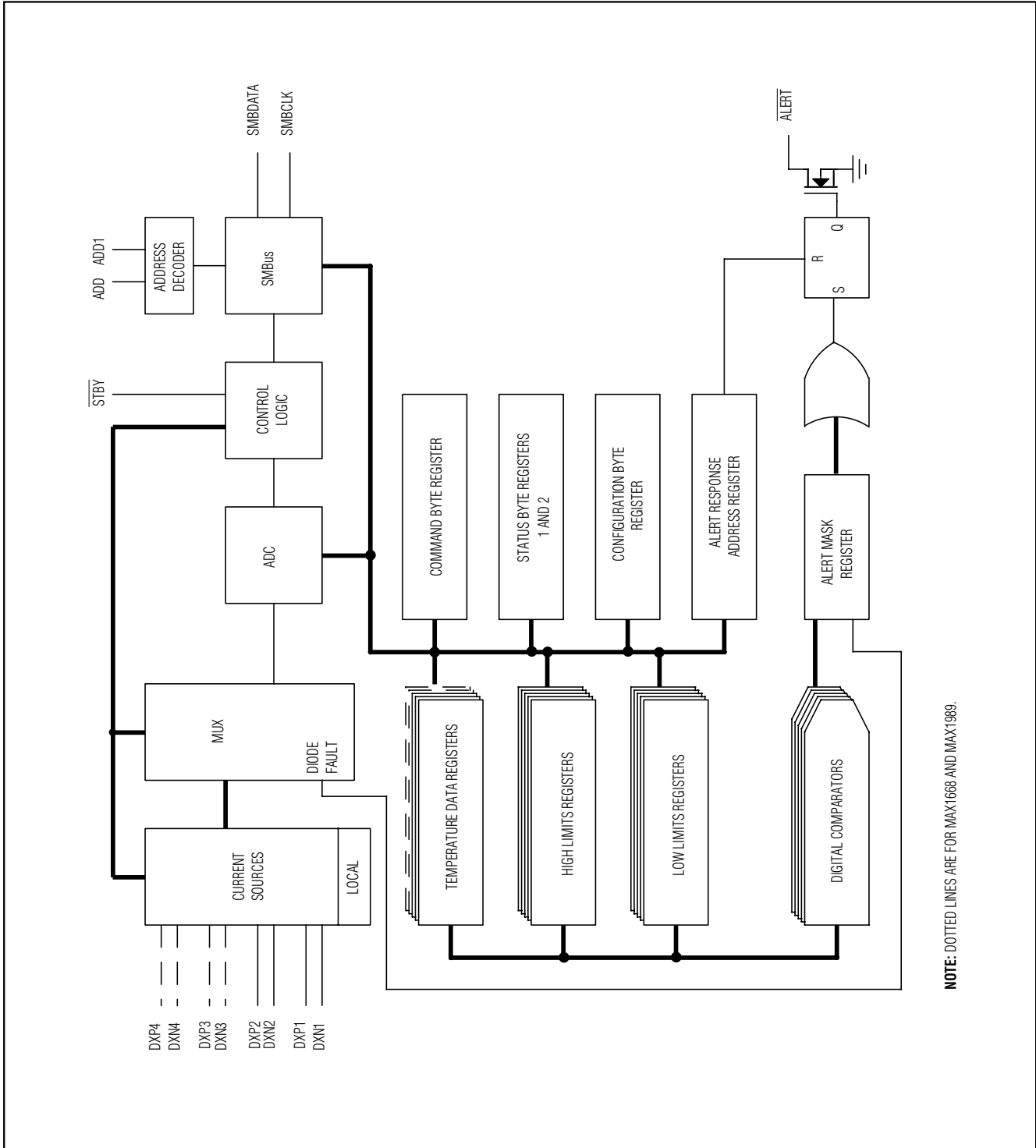

**NOTE:** DOTTED LINES ARE FOR MAX1668 AND MAX1989.

Figure 1. MAX1668/MAX1805/MAX1989 Functional Diagram

# Multichannel Remote/Local Temperature Sensors

## A/D Conversion Sequence

If a start command is written (or generated automatically in the free-running autoconvert mode), all channels are converted, and the results of all measurements are available after the end of conversion. A BUSY status bit in the status byte shows that the device is actually performing a new conversion; however, even if the ADC is busy, the results of the previous conversion are always available.

## Remote-Diode Selection

Temperature accuracy depends on having a good-quality, diode-connected small-signal transistor. Accuracy has been experimentally verified for all of the devices listed in Table 1. The MAX1668/MAX1805/MAX1989 can also directly measure the die temperature of CPUs and other ICs having on-board temperature-sensing diodes.

The transistor must be a small-signal type, either NPN or PNP, with a relatively high forward voltage; otherwise, the A/D input voltage range can be violated. The forward voltage must be greater than 0.25V at 10 $\mu$ A; check to ensure this is true at the highest expected temperature. The forward voltage must be less than 0.95V at 100 $\mu$ A; check to ensure this is true at the lowest expected temperature. Large power transistors do not work at all. Also, ensure that the base resistance is less than 100 $\Omega$ . Tight specifications for forward-current gain (+50 to +150, for example) indicate that the manufacturer has good process controls and that the devices have consistent VBE characteristics.

For heat-sink mounting, the 500-32BT02-000 thermal sensor from Fenwal Electronics is a good choice. This device consists of a diode-connected transistor, an aluminum plate with screw hole, and twisted-pair cable (Fenwal Inc., Milford, MA, 508-478-6000).

## Thermal Mass and Self-Heating

Thermal mass can seriously degrade the MAX1668/MAX1805/MAX1989s' effective accuracy. The thermal time constant of the 16-pin QSOP package is about 140s in still air. For the MAX1668/MAX1805/MAX1989 junction temperature to settle to within +1 $^{\circ}$ C after a sudden +100 $^{\circ}$ C change requires about five time constants or 12 minutes. The use of smaller packages for remote sensors, such as SOT23s, improves the situation. Take care to account for thermal gradients between the heat source and the sensor, and ensure that stray air currents across the sensor package do not interfere with measurement accuracy.

Self-heating does not significantly affect measurement accuracy. Remote-sensor self-heating due to the diode current source is negligible. For the local diode, the

**Table 1. Remote-Sensor Transistor Manufacturers**

| MANUFACTURER                 | MODEL NO.     |
|------------------------------|---------------|
| Central Semiconductor (USA)  | CMPT3904      |
| Motorola (USA)               | MMBT3904      |
| National Semiconductor (USA) | MMBT3904      |
| Rohm Semiconductor (Japan)   | SST3904       |
| Samsung (Korea)              | KST3904-TF    |
| Siemens (Germany)            | SMBT3904      |
| Zetex (England)              | FMMT3904CT-ND |

**Note:** Transistors must be diode connected (base shorted to collector).

worst-case error occurs when sinking maximum current at the  $\overline{\text{ALERT}}$  output. For example, with  $\overline{\text{ALERT}}$  sinking 1mA, the typical power dissipation is  $V_{CC} \times 400\mu\text{A}$  plus  $0.4\text{V} \times 1\text{mA}$ . Package theta J-A is about 150 $^{\circ}$ C/W, so with  $V_{CC} = 5\text{V}$  and no copper PC board heat sinking, the resulting temperature rise is:

$$\text{dT} = 2.4\text{mW} \times 150^{\circ}\text{C/W} = 0.36^{\circ}\text{C}$$

Even with these contrived circumstances, it is difficult to introduce significant self-heating errors.

## ADC Noise Filtering

The ADC is an integrating type with inherently good noise rejection, especially of low-frequency signals such as 60Hz/120Hz power-supply hum. Micropower operation places constraints on high-frequency noise rejection; therefore, careful PC board layout and proper external noise filtering are required for high-accuracy remote measurements in electrically noisy environments.

High-frequency EMI is best filtered at DXP\_ and DXN\_ with an external 2200pF capacitor. This value can be increased to about 3300pF (max), including cable capacitance. Higher capacitance than 3300pF introduces errors due to the rise time of the switched current source.

Nearly all noise sources tested cause additional error measurements, typically by +1 $^{\circ}$ C to +10 $^{\circ}$ C, depending on the frequency and amplitude (see the *Typical Operating Characteristics*).

## PC Board Layout

- 1) Place the MAX1668/MAX1805/MAX1989 as close as practical to the remote diode. In a noisy environment, such as a computer motherboard, this distance can



# Multichannel Remote/Local Temperature Sensors

be 4in to 8in (typ) or more as long as the worst noise sources (such as CRTs, clock generators, memory buses, and ISA/PCI buses) are avoided.

- 2) Do not route the DXP\_ to DXN\_ lines next to the deflection coils of a CRT. Also, do not route the traces across a fast memory bus, which can easily introduce +30°C error, even with good filtering. Otherwise, most noise sources are fairly benign.
- 3) Route the DXP\_ and DXN\_ traces in parallel and in close proximity to each other, away from any high-voltage traces such as +12VDC. Leakage currents from PC board contamination must be dealt with carefully, since a 20MΩ leakage path from DXP\_ to ground causes about +1°C error.
- 4) Connect guard traces to GND on either side of the DXP\_ to DXN\_ traces (Figure 2). With guard traces in place, routing near high-voltage traces is no longer an issue.
- 5) Route through as few vias and crossunders as possible to minimize copper/solder thermocouple effects.
- 6) When introducing a thermocouple, make sure that both the DXP\_ and the DXN\_ paths have matching thermocouples. In general, PC board-induced thermocouples are not a serious problem. A copper-solder thermocouple exhibits 3μV/°C, and it takes about 200μV of voltage error at DXP\_ to DXN\_ to cause a +1°C measurement error. So, most parasitic thermocouple errors are swamped out.
- 7) Use wide traces. Narrow ones are more inductive and tend to pick up radiated noise. The 10mil widths and spacings recommended in Figure 2 are not absolutely necessary (as they offer only a minor improvement in leakage and noise), but try to use them where practical.
- 8) Copper cannot be used as an EMI shield, and only ferrous materials such as steel work well. Placing a copper ground plane between the DXP\_ to DXN\_ traces and traces carrying high-frequency noise signals does not help reduce EMI.

## PC Board Layout Checklist

- Place the MAX1668/MAX1805/MAX1989 as close as possible to the remote diodes.
- Keep traces away from high voltages (+12V bus).
- Keep traces away from fast data buses and CRTs.
- Use recommended trace widths and spacings.
- Place a ground plane under the traces.
- Use guard traces flanking DXP\_ and DXN\_ and connecting to GND.

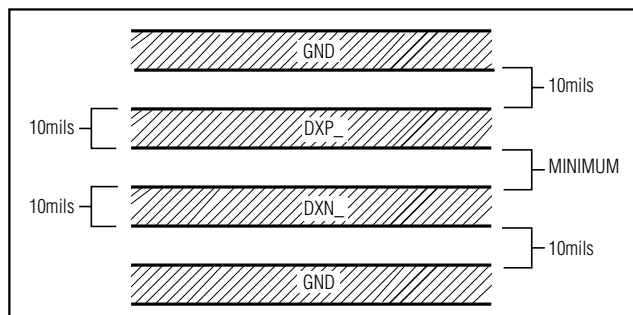

Figure 2. Recommended DXP\_/DXN\_ PC Traces

- Place the noise filter and the 0.1μF V<sub>CC</sub> bypass capacitors close to the MAX1668/MAX1805/MAX1989.
- Add a 200Ω resistor in series with V<sub>CC</sub> for best noise filtering (see the *Typical Operating Circuit*).

## Twisted-Pair and Shielded Cables

For remote-sensor distances longer than 8in, or in particularly noisy environments, a twisted pair is recommended. Its practical length is 6ft to 12ft (typ) before noise becomes a problem, as tested in a noisy electronics laboratory. For longer distances, the best solution is a shielded twisted pair like that used for audio microphones. For example, Belden #8451 works well for distances up to 100ft in a noisy environment. Connect the twisted pair to DXP\_ and DXN\_ and the shield to GND, and leave the shield's remote end unterminated.

Excess capacitance at DX\_ \_ limits practical remote-sensor distances (see the *Typical Operating Characteristics*). For very long cable runs, the cable's parasitic capacitance often provides noise filtering, so the 2200pF capacitor can often be removed or reduced in value.

Cable resistance also affects remote-sensor accuracy; 1Ω series resistance introduces about +0.5°C error.

## Low-Power Standby Mode

Standby mode disables the ADC and reduces the supply-current drain to less than 12μA. Enter standby mode by forcing the  $\overline{\text{STBY}}$  pin low or through the RUN/STOP bit in the configuration byte register. Hardware and software standby modes behave almost identically: all data is retained in memory, and the SMB interface is alive and listening for reads and writes.

Activate hardware standby mode by forcing the  $\overline{\text{STBY}}$  pin low. In a notebook computer, this line can be connected to the system SUSTAT# suspend-state signal.

The  $\overline{\text{STBY}}$  pin low state overrides any software conversion command. If a hardware or software standby command is received while a conversion is in progress, the conver-

# Multichannel Remote/Local Temperature Sensors

sion cycle is truncated, and the data from that conversion is not latched into either temperature-reading register. The previous data is not changed and remains available.

In standby mode, supply current drops to about 3µA. At very low supply voltages (under the power-on-reset threshold), the supply current is higher due to the address pin bias currents. It can be as high as 100µA, depending on ADD0 and ADD1 settings.

### SMBus Digital Interface

From a software perspective, the MAX1668/MAX1805/MAX1989 appear as a set of byte-wide registers that contain temperature data, alarm threshold values, or control bits. A standard SMBus 2-wire serial interface is used to read temperature data and write control bits and alarm threshold data. Each A/D channel within the devices responds to the same SMBus slave address for normal reads and writes.

The MAX1668/MAX1805/MAX1989 employ four standard SMBus protocols: write byte, read byte, send byte, and receive byte (Figure 3). The shorter receive byte protocol allows quicker transfers, provided that the correct data register was previously selected by a read byte instruc-

tion. Use caution with the shorter protocols in multimaster systems, since a second master could overwrite the command byte without informing the first master.

The temperature data format is 7 bits plus sign in two's-complement form for each channel, with each data bit representing 1°C (Table 2), transmitted MSB first. Measurements are offset by +0.5°C to minimize internal rounding errors; for example, +99.6°C is reported as +100°C.

### Alarm Threshold Registers

Ten (six for MAX1805) registers store alarm threshold data, with high-temperature (T<sub>HIGH</sub>) and low-temperature (T<sub>LOW</sub>) registers for each A/D channel. If either measured temperature equals or exceeds the corresponding alarm threshold value, an  $\overline{\text{ALERT}}$  interrupt is asserted.

The power-on-reset (POR) state of all T<sub>HIGH</sub> registers of the MAX1668 and MAX1805 is full scale (0111 1111, or +127°C). The POR state of the channel 1 T<sub>HIGH</sub> register of the MAX1989 is 0110 1110 or +110°C, while all other channels are at +127°C. The POR state of all T<sub>LOW</sub> registers is 1100 1001 or -55°C.

#### Write Byte Format

| S | ADDRESS | WR | ACK | COMMAND | ACK | DATA   | ACK | P |
|---|---------|----|-----|---------|-----|--------|-----|---|
|   | 7 bits  |    |     | 8 bits  |     | 8 bits |     | 1 |

Slave Address: equivalent to chip-select line of a 3-wire interface

Command Byte: selects which register you are writing to

Data Byte: data goes into the register set by the command byte (to set thresholds, configuration masks, and sampling rate)

#### Read Byte Format

| S | ADDRESS | WR | ACK | COMMAND | ACK | S | ADDRESS | RD | ACK | DATA   | /// | P |
|---|---------|----|-----|---------|-----|---|---------|----|-----|--------|-----|---|
|   | 7 bits  |    |     | 8 bits  |     |   | 7 bits  |    |     | 8 bits |     |   |

Slave Address: equivalent to chip-select line

Command Byte: selects which register you are reading from

Slave Address: repeated due to change in data-flow direction

Data Byte: reads from the register set by the command byte

#### Send Byte Format

| S | ADDRESS | WR | ACK | COMMAND | ACK | P |
|---|---------|----|-----|---------|-----|---|
|   | 7 bits  |    |     | 8 bits  |     |   |

Command Byte: sends command with no data

#### Receive Byte Format

| S | ADDRESS | RD | ACK | DATA   | /// | P |
|---|---------|----|-----|--------|-----|---|
|   | 7 bits  |    |     | 8 bits |     |   |

Data Byte: This command only works immediately following a Read Byte. Reads data from the register commanded by that last Read Byte; also used for SMBus Alert Response return address

S = Start condition    Shaded = Slave transmission  
P = Stop condition    /// = Not acknowledged

Figure 3. SMBus Protocols

# Multichannel Remote/Local Temperature Sensors

**Table 2. Data Format (Two's Complement)**

| TEMP (°C) | ROUNDED TEMP (°C) | DIGITAL OUTPUT DATA BITS |     |      |
|-----------|-------------------|--------------------------|-----|------|
|           |                   | SIGN                     | MSB | LSB  |
| +130.00   | +127              | 0                        | 111 | 1111 |
| +127.00   | +127              | 0                        | 111 | 1111 |
| +126.50   | +127              | 0                        | 111 | 1111 |
| +126.00   | +126              | 0                        | 111 | 1110 |
| +25.25    | +25               | 0                        | 001 | 1001 |
| +0.50     | +1                | 0                        | 000 | 0000 |
| +0.25     | +0                | 0                        | 000 | 0000 |
| +0.00     | +0                | 0                        | 000 | 0000 |
| -0.25     | +0                | 0                        | 000 | 0000 |
| -0.50     | +0                | 0                        | 000 | 0000 |
| -0.75     | -1                | 1                        | 111 | 1111 |
| -1.00     | -1                | 1                        | 111 | 1111 |
| -25.00    | -25               | 1                        | 110 | 0111 |
| -25.50    | -25               | 1                        | 110 | 0110 |
| -54.75    | -55               | 1                        | 100 | 1001 |
| -55.00    | -55               | 1                        | 100 | 1001 |
| -65.00    | -65               | 1                        | 011 | 1111 |
| -70.00    | -65               | 1                        | 011 | 1111 |

### Diode Fault Alarm

There is a continuity fault detector at DXP\_ that detects whether the remote diode has an open-circuit condition. At the beginning of each conversion, the diode fault is checked, and the status byte is updated. This fault detector is a simple voltage detector; if DXP\_ rises above V<sub>CC</sub> - 1V (typ) due to the diode current source, a fault is detected. Note that the diode fault is not checked until a conversion is initiated, so immediately after power-on reset, the status byte indicates no fault is present, even if the diode path is broken.

If any remote channel is shorted (DXP\_ to DXN\_ or DXP\_ to GND), the ADC reads 0000 0000 so as not to trip either the T<sub>HIGH</sub> or T<sub>LOW</sub> alarms at their POR settings. In applications that are never subjected to 0°C in normal operation, a 0000 0000 result can be checked to indicate a fault condition in which DXP\_ is accidentally short circuited. Similarly, if DXP\_ is short circuited to V<sub>CC</sub>, the ADC reads +127°C for all remote and local channels, and the device alarms.

### ALERT Interrupts

The ALERT interrupt output signal is latched and can only be cleared by reading the alert response address.

**Table 3. Read Format for Alert Response Address (0001100)**

| BIT     | NAME | FUNCTION  |
|---------|------|---|
| 7 (MSB) | ADD7 | Provide the current MAX1668/MAX1805/MAX1989 slave address that was latched at POR (Table 8) |
| 6       | ADD6 |   |
| 5       | ADD5 |   |
| 4       | ADD4 |   |
| 3       | ADD3 |   |
| 2       | ADD2 |   |
| 1       | ADD1 |   |
| 0 (LSB) | 1    | Logic 1   |

Interrupts are generated in response to T<sub>HIGH</sub> and T<sub>LOW</sub> comparisons and when a remote diode is disconnected (for continuity fault detection). The interrupt does not halt automatic conversions; new temperature data continues to be available over the SMBus interface after ALERT is asserted. The interrupt output pin is open drain so that devices can share a common interrupt line. The interrupt rate can never exceed the conversion rate.

The interface responds to the SMBus alert response address, an interrupt pointer return-address feature (see *Alert Response Address* section). Prior to taking corrective action, always check to ensure that an interrupt is valid by reading the current temperature.

### Alert Response Address

The SMBus alert response interrupt pointer provides quick fault identification for simple slave devices that lack the complex, expensive logic needed to be a bus master. Upon receiving an ALERT interrupt signal, the host master can broadcast a receive byte transmission to the alert response slave address (0001 100). Then any slave device that generated an interrupt attempts to identify itself by putting its own address on the bus (Table 3).

The alert response can activate several different slave devices simultaneously, similar to the I<sup>2</sup>C general call. If more than one slave attempts to respond, bus arbitration rules apply, and the device with the lower address code wins. The losing device does not generate an acknowledge and continues to hold the ALERT line low until serviced (implies that the host interrupt input is

# Multichannel Remote/Local Temperature Sensors

level sensitive). Successful reading of the alert response address clears the interrupt latch.

## Command Byte Functions

The 8-bit command byte register (Table 4) is the master index that points to the various other registers within the MAX1668/MAX1805/MAX1989. The register's POR

state is 0000 0000, so that a receive byte transmission (a protocol that lacks the command byte) that occurs immediately after POR returns the current local temperature data.

**Table 4. Command Byte Bit Assignments for MAX1668/MAX1805/MAX1989**

| REGISTER | COMMAND | POR STATE                            | FUNCTION  |
|----------|---------|--------------------------------------|---|
| RIT      | 00h     | 0000 0000*                           | Read local temperature                            |
| RET1     | 01h     | 0000 0000*                           | Read remote DX1 temperature                       |
| RET2     | 02h     | 0000 0000*                           | Read remote DX2 temperature                       |
| RET3**   | 03h     | 0000 0000*                           | Read remote DX3 temperature                       |
| RET4**   | 04h     | 0000 0000*                           | Read remote DX4 temperature                       |
| RS1      | 05h     | 0000 0000                            | Read status byte 1                                |
| RS2      | 06h     | 0000 0000                            | Read status byte 2                                |
| RC       | 07h     | 0000 0000                            | Read Configuration Byte                           |
| RIHL     | 08h     | 0111 1111                            | Read local T <sub>HIGH</sub> limit                |
| RILL     | 09h     | 1100 1001                            | Read local T <sub>LOW</sub> limit                 |
| REHL1    | 0Ah     | 0111 1111<br>(0110 1110)             | Read remote DX1 T <sub>HIGH</sub> limit (MAX1989) |
| RELL1    | 0Bh     | 1100 1001                            | Read remote DX1 T <sub>LOW</sub> limit            |
| REHL2    | 0Ch     | 0111 1111                            | Read remote DX2 T <sub>HIGH</sub> limit           |
| RELL2    | 0Dh     | 1100 1001                            | Read remote DX2 T <sub>LOW</sub> limit            |
| REHL3**  | 0Eh     | 0111 1111                            | Read remote DX3 T <sub>HIGH</sub> limit           |
| RELL3**  | 0Fh     | 1100 1001                            | Read remote DX3 T <sub>LOW</sub> limit            |
| REHL4**  | 10h     | 0111 1111                            | Read remote DX4 T <sub>HIGH</sub> limit           |
| RELL4**  | 11h     | 1100 1001                            | Read remote DX4 T <sub>LOW</sub> limit            |
| WC       | 12h     | N/A                                  | Write configuration byte                          |
| WIHL     | 13h     | N/A                                  | Write local T <sub>HIGH</sub> limit               |
| WILL     | 14h     | N/A                                  | Write local T <sub>LOW</sub> limit                |
| WEHI1    | 15h     | N/A                                  | Write remote DX1 T <sub>HIGH</sub> limit          |
| WELL1    | 16h     | N/A                                  | Write remote DX1 T <sub>LOW</sub> limit           |
| WEHI2    | 17h     | N/A                                  | Write remote DX2 T <sub>HIGH</sub> limit          |
| WELL2    | 18h     | N/A                                  | Write remote DX2 T <sub>LOW</sub> limit           |
| WEHI3**  | 19h     | N/A                                  | Write remote DX3 T <sub>HIGH</sub> limit          |
| WELL3**  | 1Ah     | N/A                                  | Write remote DX3 T <sub>LOW</sub> limit           |
| WEHI4**  | 1Bh     | N/A                                  | Write remote DX4 T <sub>HIGH</sub> limit          |
| WELL4**  | 1Ch     | N/A                                  | Write remote DX4 T <sub>LOW</sub> limit           |
| MFG ID   | FEh     | 0100 1101                            | Read manufacture ID                               |
| DEV ID   | FFh     | 0000 0011 (0000 0101)<br>[0000 1011] | Read device ID (for MAX1805) [for MAX1989]        |

\*If the device is in hardware standby mode at POR, all temperature registers read 0°C.

\*\*Not available for MAX1805.

# Multichannel Remote/Local Temperature Sensors

## Manufacturer and Device ID Codes

Two ROM registers provide manufacturer and device ID codes. Reading the manufacturer ID returns 4Dh, which is the ASCII code M (for Maxim). Reading the device ID returns 03h for MAX1668, 05h for MAX1805, and 0Bh for MAX1989. If the read word 16-bit SMBus protocol is employed (rather than the 8-bit Read Byte), the least significant byte contains the data and the most significant byte contains 00h in both cases.

## Configuration Byte Functions

The configuration byte register (Table 5) is used to mask (disable) interrupts and to put the device in software standby mode.

## Status Byte Functions

The two status byte registers (Tables 6 and 7) indicate which (if any) temperature thresholds have been exceeded. The first byte also indicates whether the ADC is converting and whether there is an open circuit in a remote-diode DXP\_ to DXN\_ path. After POR, the normal state of all the flag bits is zero, assuming none of the alarm conditions are present. The status byte is cleared by any successful read of the status byte, unless the fault persists. Note that the  $\overline{\text{ALERT}}$  interrupt latch is not automatically cleared when the status flag bit is cleared.

When reading the status byte, you must check for internal bus collisions caused by asynchronous ADC timing, or else disable the ADC prior to reading the status byte (through the RUN/STOP bit in the configuration byte).

To check for internal bus collisions, read the status byte. If the least significant 7 bits are ones, discard the data and read the status byte again. The status bits LHIGH, LLOW, RHIGH, and RLOW are refreshed on the SMBus clock edge immediately following the stop condition, so there is no danger of losing temperature-related status data as a result of an internal bus collision. The OPEN status bit (diode continuity fault) is only refreshed at the beginning of a conversion, so OPEN data is lost. The  $\overline{\text{ALERT}}$  interrupt latch is independent of the status byte register, so no false alerts are generated by an internal bus collision.

If the THIGH and TLOW limits are close together, it's possible for both high-temp and low-temp status bits to be set, depending on the amount of time between status read operations (especially when converting at the fastest rate). In these circumstances, it's best not to rely

on the status bits to indicate reversals in long-term temperature changes and instead use a current temperature reading to establish the trend direction.

## Conversion Rate

The MAX1668/MAX1805/MAX1989 are continuously measuring temperature on each channel. The typical conversion rate is approximately three conversions/s (for both devices). The resulting data is stored in the temperature data registers.

## Slave Addresses

The MAX1668/MAX1805/MAX1989 appear to the SMBus as one device having a common address for all ADC channels. The device address can be set to one of nine different values by pin-strapping ADD0 and ADD1 so that more than one MAX1668/MAX1805/MAX1989 can reside on the same bus without address conflicts (Table 8).

The address pin states are checked at POR only, and the address data stays latched to reduce quiescent supply current due to the bias current needed for high-Z state detection.

The MAX1668/MAX1805/MAX1989 also respond to the SMBus alert response slave address (see the *Alert Response Address* section).

## POR and Undervoltage Lockout

The MAX1668/MAX1805/MAX1989 have a volatile memory. To prevent ambiguous power-supply conditions from corrupting the data in memory and causing erratic behavior, a POR voltage detector monitors VCC and clears the memory if VCC falls below 1.8V (typ, see the *Electrical Characteristics* table). When power is first applied and VCC rises above 1.85V (typ), the logic blocks begin operating, although reads and writes at VCC levels below 3V are not recommended. A second VCC comparator, the ADC UVLO comparator, prevents the ADC from converting until there is sufficient headroom (VCC = 2.8V typ).

## Power-Up Defaults

- Interrupt latch is cleared.
- Address select pins are sampled.
- ADC begins converting.
- Command byte is set to 00h to facilitate quick remote receive byte queries.
- THIGH and TLOW registers are set to max and min limits, respectively.

# Multichannel Remote/Local Temperature Sensors

**Table 5. Configuration Byte Bit Assignments**

| BIT     | NAME     | POR | FUNCTION   |
|---------|----------|-----|--|
| 7 (MSB) | MASKALL  | 0   | Masks all $\overline{\text{ALERT}}$ interrupts when high.  |
| 6       | RUN/STOP | 0   | Standby mode control bit. If high, the device immediately stops converting and enters standby mode. If low, the device converts. |
| 5       | MASK4*   | 0   | Masks remote DX4 interrupts when high.   |
| 4       | MASK3*   | 0   | Masks remote DX3 interrupts when high.   |
| 3       | MASK2    | 0   | Masks remote DX2 interrupts when high.   |
| 2       | MASK1    | 0   | Masks remote DX1 interrupts when high.   |
| 0       | IBIAS1   | 0   | Medium/low-bias control bit. High = low bias, low = medium bias. IBIAS0 must be low.   |
| 1       | IBIAS0   | 0   | High-bias control bit. High bias on DXP_ when high. Overrides IBIAS1.  |

\*Not available for MAX1805.

**Table 6. Status Byte Bit 1 Assignments**

| BIT     | NAME               | FUNCTION   |
|---------|--------------------|--|
| 7 (MSB) | BUSY               | A high indicates that the ADC is busy converting.                                  |
| 6       | LHIGH <sup>†</sup> | A high indicates that the local high-temperature alarm has activated.              |
| 5       | LLOW <sup>†</sup>  | A high indicates that the local low-temperature alarm has activated.               |
| 4       | OPEN <sup>†</sup>  | A high indicates one of the remote-diode continuity (open-circuit) faults.         |
| 3       | ALARM <sup>†</sup> | A high indicates one of the remote-diode channels has over/undertemperature alarm. |
| 2       | N/A                | N/A  |
| 1       | N/A                | N/A  |
| 0       | N/A                | N/A  |

<sup>†</sup>These flags stay high until cleared by POR, or until the status byte register is read.

**Table 7. Status Byte 2 Bit Assignments**

| BIT     | NAME    | FUNCTION  |
|---------|---------|---|
| 7 (MSB) | RLOW1   | A high indicates that the DX1 low-temperature alarm has activated.  |
| 6       | RHIGH1  | A high indicates that the DX1 high-temperature alarm has activated. |
| 5       | RLOW2   | A high indicates that the DX2 low-temperature alarm has activated.  |
| 4       | RHIGH2  | A high indicates that the DX2 high-temperature alarm has activated. |
| 3       | RLOW3*  | A high indicates that the DX3 low-temperature alarm has activated.  |
| 2       | RHIGH3* | A high indicates that the DX3 high-temperature alarm has activated. |
| 1       | RLOW4*  | A high indicates that the DX4 low-temperature alarm has activated.  |
| 0       | RHIGH4* | A high indicates that the DX4 high-temperature alarm has activated. |

**Note:** All flags in this byte stay high until cleared by POR or until the status byte is read.

\*Not available for MAX1805.

# Multichannel Remote/Local Temperature Sensors

MAX1668/MAX1805/MAX1989

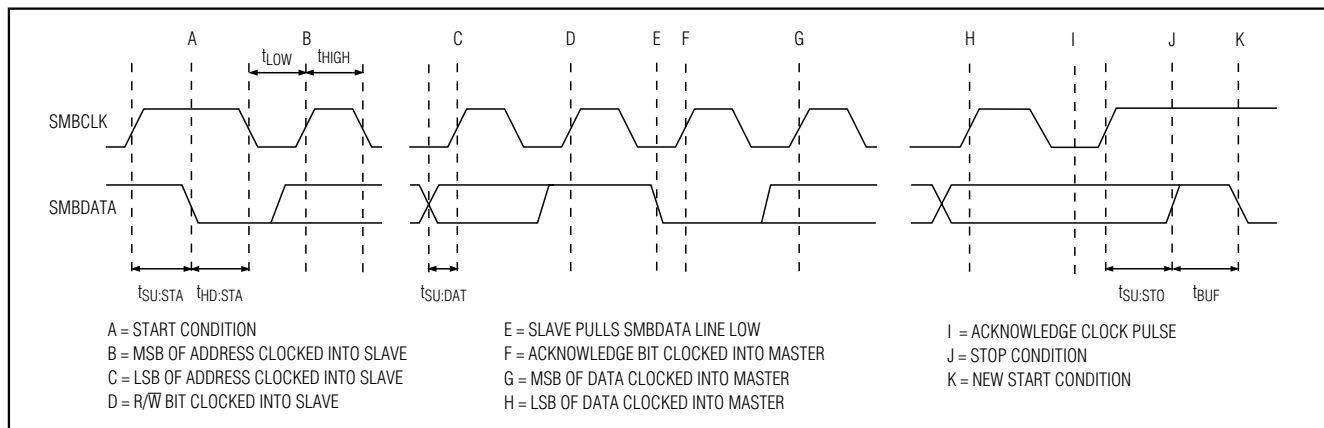

Figure 4. SMBus Read Timing Diagram

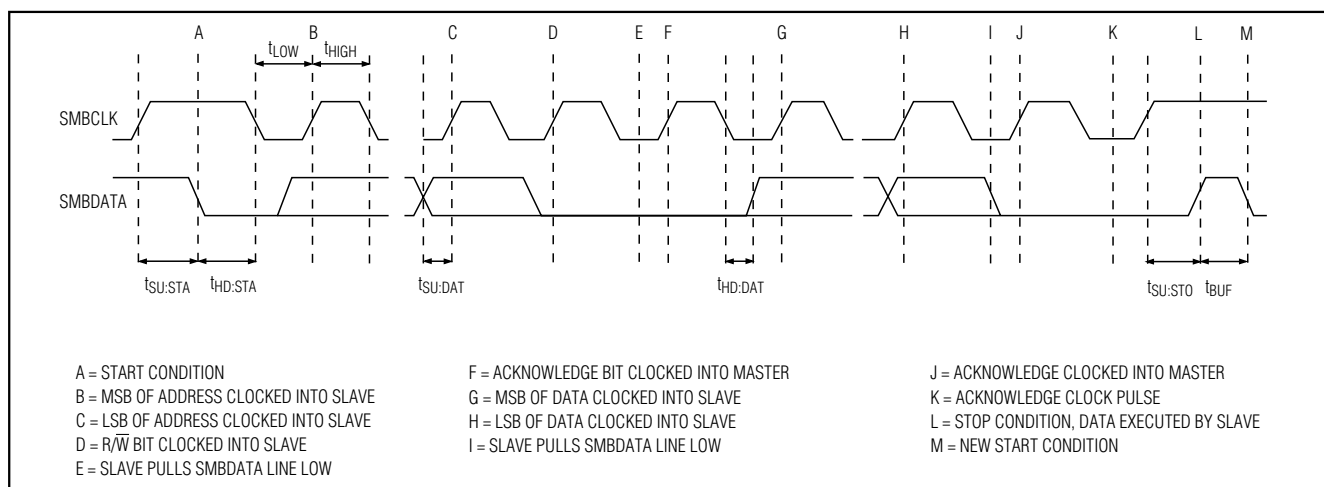

Figure 5. SMBus Write Timing Diagram

**Table 8. Slave Address Decoding (ADD0 and ADD1)**

| ADD0            | ADD1            | ADDRESS  |
|-----------------|-----------------|----------|
| GND             | GND             | 0011 000 |
| GND             | High-Z          | 0011 001 |
| GND             | V <sub>CC</sub> | 0011 010 |
| High-Z          | GND             | 0101 001 |
| High-Z          | High-Z          | 0101 010 |
| High-Z          | V <sub>CC</sub> | 0101 011 |
| V <sub>CC</sub> | GND             | 1001 100 |
| V <sub>CC</sub> | High-Z          | 1001 101 |
| V <sub>CC</sub> | V <sub>CC</sub> | 1001 110 |

**Note:** High-Z means that the pin is left unconnected and floating.

# Multichannel Remote/Local Temperature Sensors

## Package Information

(The package drawing(s) in this data sheet may not reflect the most current specifications. For the latest package outline information go to [www.maxim-ic.com/packages](http://www.maxim-ic.com/packages).)

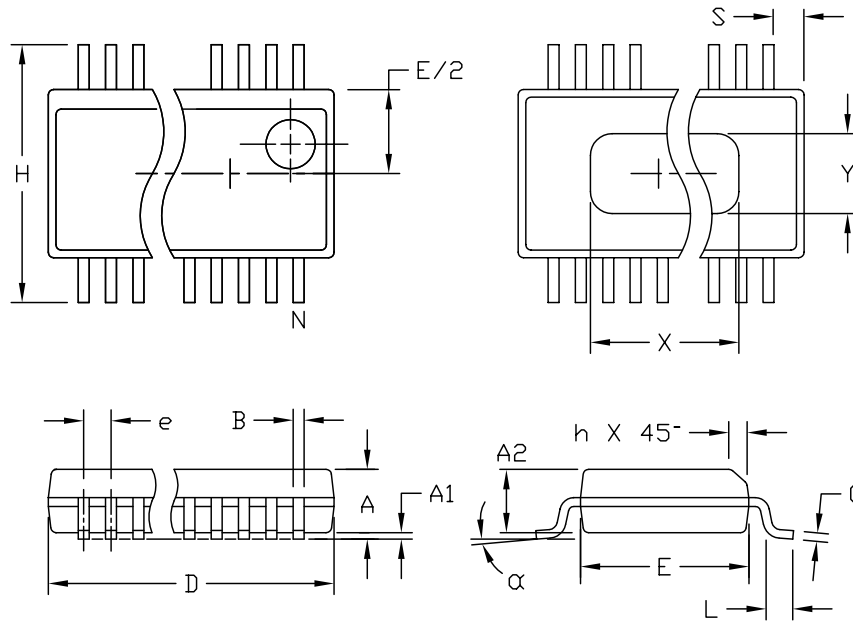

| DIM | INCHES         |       | MILLIMETERS |       |
|-----|----------------|-------|-------------|-------|
|     | MIN            | MAX   | MIN         | MAX   |
| A   | .061           | .068  | 1.55        | 1.73  |
| A1  | .004           | .0098 | 0.102       | 0.249 |
| A2  | .055           | .061  | 1.40        | 1.55  |
| B   | .008           | .012  | 0.20        | 0.31  |
| C   | .0075          | .0098 | 0.191       | 0.249 |
| D   | SEE VARIATIONS |       |             |       |
| E   | .150           | .157  | 3.81        | 3.99  |
| e   | .025 BSC       |       | 0.635 BSC   |       |
| H   | .230           | .244  | 5.84        | 6.20  |
| h   | .010           | .016  | 0.25        | 0.41  |
| L   | .016           | .035  | 0.41        | 0.89  |
| N   | SEE VARIATIONS |       |             |       |
| X   | SEE VARIATIONS |       |             |       |
| Y   | .071           | .087  | 1.803       | 2.209 |
| α   | 0°             | 8°    | 0°          | 8°    |

### VARIATIONS:

| DIM | INCHES |       | MILLIMETERS |       | N  |    |
|-----|--------|-------|-------------|-------|----|----|
|     | MIN.   | MAX.  | MIN.        | MAX.  |    |    |
| D   | .189   | .196  | 4.80        | 4.98  | 16 | AA |
| S   | .0020  | .0070 | 0.05        | 0.18  |    |    |
| X   | .107   | .123  | 2.72        | 3.12  |    |    |
| D   | .337   | .344  | 8.56        | 8.74  | 20 | AB |
| S   | .0500  | .0550 | 1.270       | 1.397 |    |    |
| D   | .337   | .344  | 8.56        | 8.74  | 24 | AC |
| S   | .0250  | .0300 | 0.635       | 0.762 |    |    |
| D   | .386   | .393  | 9.80        | 9.98  | 28 | AD |
| S   | .0250  | .0300 | 0.635       | 0.762 |    |    |
| X   | .271   | .287  | 6.88        | 7.29  |    |    |

### NOTES:

1. D & E DO NOT INCLUDE MOLD FLASH OR PROTRUSIONS.
2. MOLD FLASH OR PROTRUSIONS NOT TO EXCEED .006" PER SIDE.
3. HEAT SLUG DIMENSIONS X AND Y APPLY ONLY TO 16 AND 28 LEAD POWER-QSDP PACKAGES.
4. CONTROLLING DIMENSIONS: INCHES.
5. MEETS JEDEC MO137.

**MAXIM**

PROPRIETARY INFORMATION

TITLE:  
PACKAGE OUTLINE, QSDP, 150°, .025" LEAD PITCH

|          |                      |     |     |
|----------|----------------------|-----|-----|
| APPROVAL | DOCUMENT CONTROL NO. | REV | 1/1 |
|          | 21-0055              | C   |     |

QSDP/EP



# Multichannel Remote/Local Temperature Sensors

## Package Information (continued)

(The package drawing(s) in this data sheet may not reflect the most current specifications. For the latest package outline information go to [www.maxim-ic.com/packages](http://www.maxim-ic.com/packages).)

MAX1668/MAX1805/MAX1989

| Symbol         | COMMON DIMENSIONS |      |                |      |
|----------------|-------------------|------|----------------|------|
|                | MILLIMETERS       |      | INCHES         |      |
|                | MIN.              | MAX. | MIN.           | MAX. |
| A              | —                 | 1.10 | —              | .043 |
| A <sub>1</sub> | 0.05              | 0.15 | .002           | .006 |
| A <sub>2</sub> | 0.85              | 0.95 | .033           | .037 |
| b              | 0.19              | 0.30 | .007           | .012 |
| b <sub>1</sub> | 0.19              | 0.25 | .007           | .010 |
| c              | 0.09              | 0.20 | .004           | .008 |
| c <sub>1</sub> | 0.09              | 0.14 | .004           | .006 |
| D              | SEE VARIATIONS    |      | SEE VARIATIONS |      |
| E              | 4.30              | 4.50 | .169           | .177 |
| e              | 0.65 BSC          |      | .026 BSC       |      |
| H              | 6.25              | 6.55 | .246           | .258 |
| L              | 0.50              | 0.70 | .020           | .028 |
| N              | SEE VARIATIONS    |      | SEE VARIATIONS |      |
| α              | 0°                | 8°   | 0°             | 8°   |

| JEDEC | MO-153 | N | VARIATIONS  |      |        |      |
|-------|--------|---|-------------|------|--------|------|
|       |        |   | MILLIMETERS |      | INCHES |      |
|       |        |   | MIN.        | MAX. | MIN.   | MAX. |
| AB-1  | 14     | D | 4.90        | 5.10 | .193   | .201 |
| AB    | 16     | D | 4.90        | 5.10 | .193   | .201 |
| AC    | 20     | D | 6.40        | 6.60 | .252   | .260 |
| AD    | 24     | D | 7.70        | 7.90 | .303   | .311 |
| AE    | 28     | D | 9.60        | 9.80 | .378   | .386 |

**NOTES:**

- DIMENSIONS D AND E DO NOT INCLUDE FLASH
- MOLD FLASH OR PROTRUSIONS NOT TO EXCEED 0.15mm PER SIDE
- CONTROLLING DIMENSION: MILLIMETER
- MEETS JEDEC OUTLINE MO-153. SEE JEDEC VARIATIONS TABLE
- "N" REFERS TO NUMBER OF LEADS
- THE LEAD TIPS MUST LIE WITHIN A SPECIFIED ZONE. THIS TOLERANCE ZONE IS DEFINED BY TWO PARALLEL PLANES. ONE PLANE IS THE SEATING PLANE, DATUM [-C-]; THE OTHER PLANE IS AT THE SPECIFIED DISTANCE FROM [-C-] IN THE DIRECTION INDICATED

TSSOP 4.40mm EPS

Maxim cannot assume responsibility for use of any circuitry other than circuitry entirely embodied in a Maxim product. No circuit patent licenses are implied. Maxim reserves the right to change the circuitry and specifications without notice at any time.

Maxim Integrated Products, 120 San Gabriel Drive, Sunnyvale, CA 94086 408-737-7600 \_\_\_\_\_ 17

## Данный компонент на территории Российской Федерации

### Вы можете приобрести в компании MosChip.

Для оперативного оформления запроса Вам необходимо перейти по данной ссылке:

<http://moschip.ru/get-element>

Вы можете разместить у нас заказ для любого Вашего проекта, будь то серийное производство или разработка единичного прибора.

В нашем ассортименте представлены ведущие мировые производители активных и пассивных электронных компонентов.

Нашей специализацией является поставка электронной компонентной базы двойного назначения, продукции таких производителей как XILINX, Intel (ex.ALTERA), Vicor, Microchip, Texas Instruments, Analog Devices, Mini-Circuits, Amphenol, Glenair.

Сотрудничество с глобальными дистрибьюторами электронных компонентов, предоставляет возможность заказывать и получать с международных складов практически любой перечень компонентов в оптимальные для Вас сроки.

На всех этапах разработки и производства наши партнеры могут получить квалифицированную поддержку опытных инженеров.

Система менеджмента качества компании отвечает требованиям в соответствии с ГОСТ Р ИСО 9001, ГОСТ РВ 0015-002 и ЭС РД 009

### Офис по работе с юридическими лицами:

105318, г.Москва, ул.Щербаковская д.3, офис 1107, 1118, ДЦ «Щербаковский»

Телефон: +7 495 668-12-70 (многоканальный)

Факс: +7 495 668-12-70 (доб.304)

E-mail: [info@moschip.ru](mailto:info@moschip.ru)

Skype отдела продаж:

moschip.ru

moschip.ru\_4

moschip.ru\_6

moschip.ru\_9