

Electronic multifunction counters with preselection

→ Up counters/Down counters - 48 x 48 - CTR48E "Essential"

- Counter, Preselection chronometer
- Maximum input frequency 5 k Hz
- Simple parameter setting, configuration using text menus
- Easy modification of presets
- Multiplication factor
- 3 A changeover relay
- Backlit LCD display (green) : 6 digits, height 9 mm
- IP 65 sealed panel
- Option of locking the keypad, completely or partially (preset, programming)
- Accessories for 72 x 72 or 55 x 55 cut-out, DIN rail adaptor



Part numbers

Type	Functions	Preset	Voltages	Output	Code
Green backlit LCD display	Counter, Preselection chronometer	1	10 → 30 V $\overline{\text{---}}$	1 relay	87629111
	Counter, Preselection chronometer	1	115 V \sim	1 relay	87629113
	Counter, Preselection chronometer	1	230 V \sim	1 relay	87629114
	Counter, Preselection chronometer	2	10 → 30 V $\overline{\text{---}}$	1 changeover relay, 1 NO relay	87629121
	Counter, Preselection chronometer	2	115 V \sim	1 changeover relay, 1 NO relay	87629123
	Counter, Preselection chronometer	2	230 V \sim	1 changeover relay, 1 NO relay	87629124

Accessories

Description	Code
Adaptor for 72 x 72 mm cut-out	26546842
Adaptor for 55 x 55 mm cut-out	26546846
DIN rail adaptor	26546841

General characteristics

Environmental characteristics

Supply	11 → 30 V $\overline{\text{---}}$ / 115 V \sim / 230 V \sim
Relative humidity (no condensation)	EN 60068-2-30 40/93% RLF
Altitude	0 < 2000 m
Certifications	CE
Vibration resistance in 3 axes	10-55 Hz/1 min/XYZ EN 60068-2-6: 30 min. in each direction
Connection by screw terminals	Débrochable
Protection	Conforming to standard EN 60529 IP65 for panel/IP20 for connections
Front panel watertight seal	✓
Temperature limits use (°C)	-10 → +50
Temperature limits stored (°C)	-25 → +75
Weight (g)	150 $\overline{\text{---}}$ version 250 \sim version

General characteristics

Reset to zero or to preset	On panel: if not locked during programming Electrical: automatic, voltage or solid state (NPN or PNP depending on programming)
Minimum pulse time	Impulse counter: < 15 ms Chronometer: 500 μ s
Option to protect against reset from front panel	✓
Scale factor (each input pulse is multiplied by this figure)	00.0001 → 99.9999
Decimal point selectable for ease of reading	0 0.0 0.00 0.000 0.0000 0.00000
Sensor supply version \sim	-40/+15% 50 mA 230 V \sim -40/+15% 40 mA 115 V \sim
Programming and current value backed up via EEPROM memory	✓
	Service life 10 years

Operating characteristics

Functions	Preselection counter, Chronometer
Number of presets	1 or 2
Display	LCD with green backlighting
Height digits (mm)	LCD 9
Display details	- 999 999 → 999 999

Input characteristics

Inputs	2 counter inputs 1 reset input, 1 locking input
Input modes	Dir: Directional AS: up/dn PP: phase
Input type	Voltage or solid state
High level	3.5 → 30 V $\overline{\text{---}}$
Low level	0 → 2 V $\overline{\text{---}}$

Relay output characteristics

Changeover relay	✓
NO contact	Depending on version
Maximum current	3 A
Minimum current	30 mA
Maximum voltage	30 V $\overline{\text{---}}$ / 250 V \sim
Min. voltage	5 V \sim
Response time	< 10 ms
Mechanical life (operations)	20 x 10 ⁶
Number of operations	1 x 10 ⁵
Output modes: maintained or pulsed	0.01 → 99.99 s

Dimensions (mm)

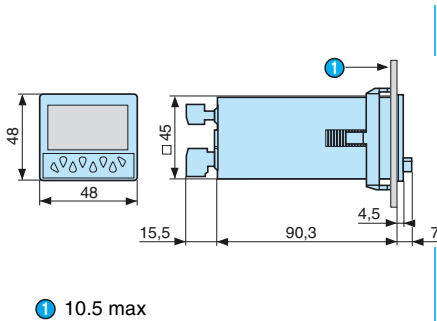

Panel cut-out

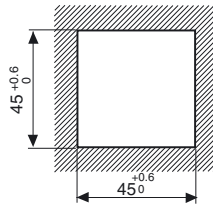

26546842 - Adaptor for 72 x 72 mm cut-out

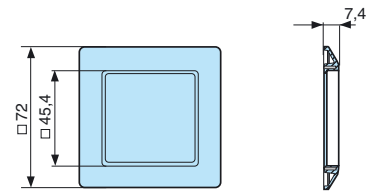

26546846 - Adaptor for 55 x 55 mm cut-out

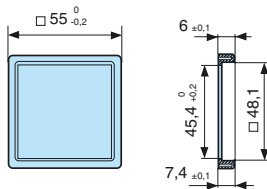

26546841 - DIN rail adaptor

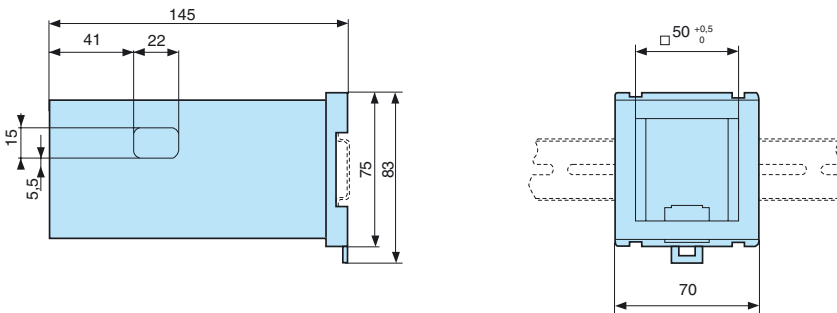

87629111

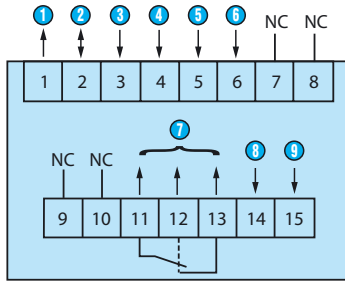

- ① Sensor voltage supply (* UB interconnected)
- ② GND (0 V₋₋₋)
- ③ INP A (signal A input)
- ④ INP B (signal B input)
- ⑤ Reset (Reset input)
- ⑥ Lock (locking switch input)
- ⑦ 11-12-13: Output 1
- ⑧ 14-15: Supply
- ⑨ Power supply - GND

87629113 / 114

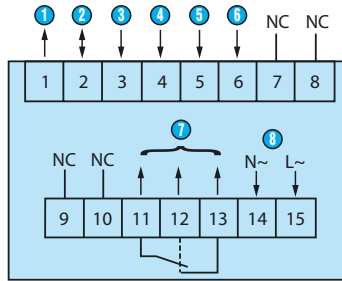

- ① Sensor voltage supply
- ② GND (0 V₋₋₋)
- ③ INP A (signal A input)
- ④ INP B (signal B input)
- ⑤ Reset (Reset input)
- ⑥ Lock (locking switch input)
- ⑦ 11-12-13: Output 1
- ⑧ 14-15: Supply

87629121

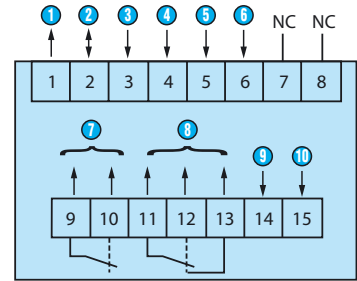

- ① Sensor voltage supply (* UB interconnected)
- ② GND (0 V₋₋₋)
- ③ INP A (signal A input)
- ④ INP B (signal B input)
- ⑤ Reset (Reset input)
- ⑥ Lock (locking switch input)
- ⑦ 9-10: Output 1
- ⑧ 11-12-13: Output 2
- ⑨ 14-15: Supply
- ⑩ Power supply - GND

87629123 / 124

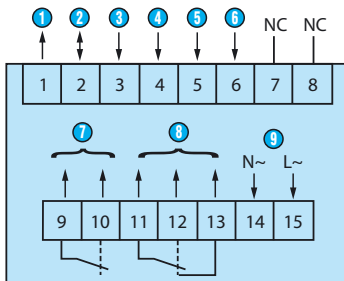

- ① Sensor voltage supply
- ② GND (0 V₋₋₋)
- ③ INP A (signal A input)
- ④ INP B (signal B input)
- ⑤ Reset (Reset input)
- ⑥ Lock (locking switch input)
- ⑦ 9-10: Output 1
- ⑧ 11-12-13: Output 2
- ⑨ 14-15: Supply

Programming diagram

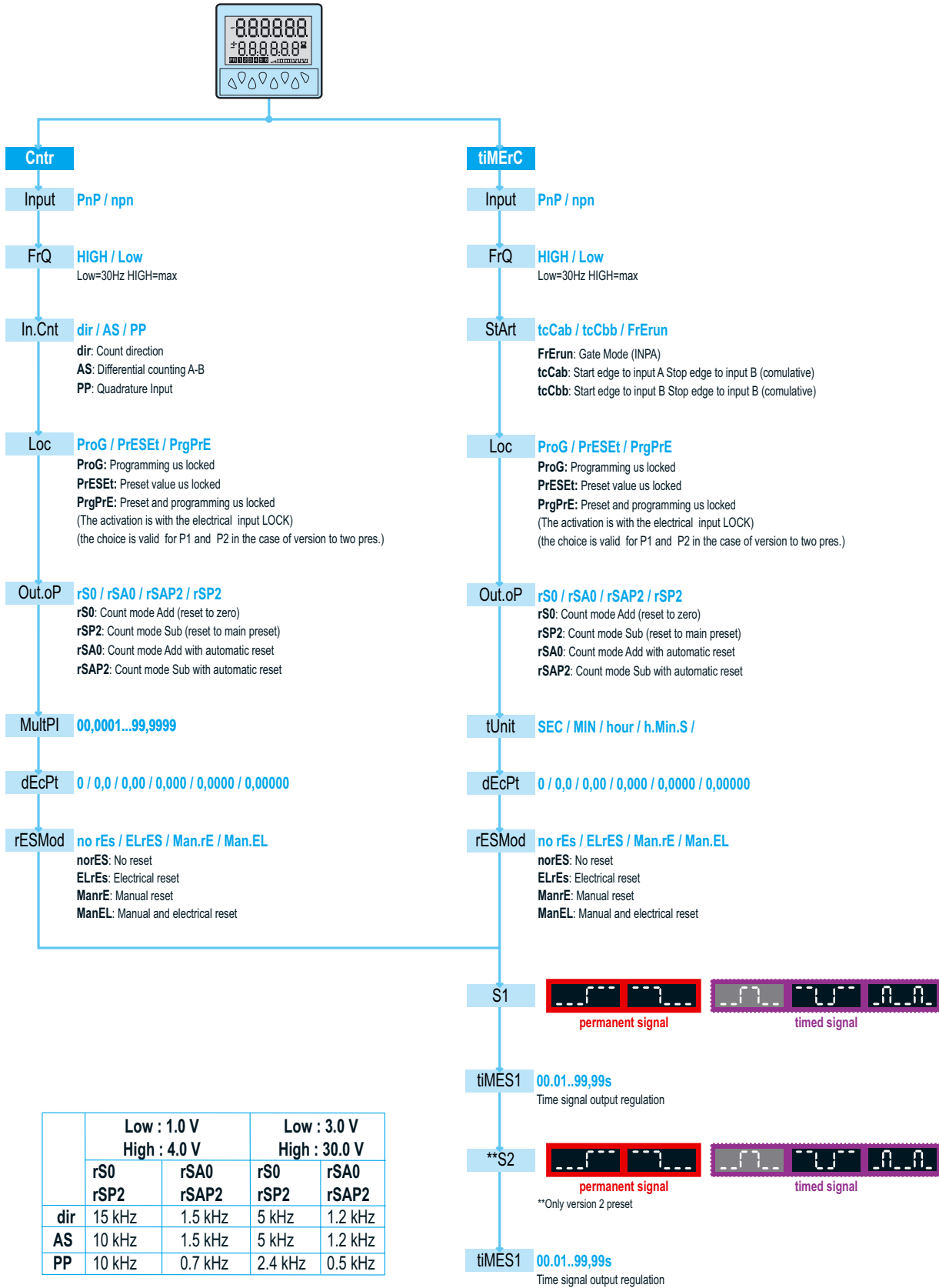

Counter: dir

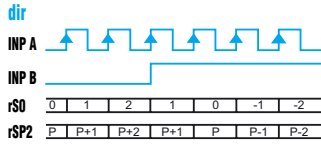

A 90° B
 Inp A: Counter input
 Counting on an edge
 Inp B: Reversal of direction
 rS0: Display 0 → Preset
 rSP2: Display Preset → 0

Chronometer: Start tcCAb

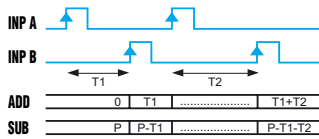

Inp A: On
 Inp B: Off
 Add: Display 0 → Preset
 Sub: Display Preset → 0

Output operation 1: rS0

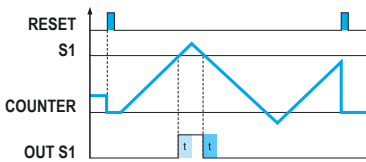

Output operation 1: rSAP2

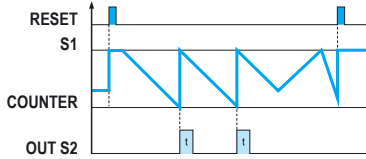

Output operation 2: rSP2

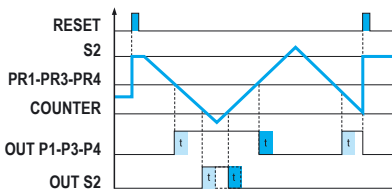

Counter: AS

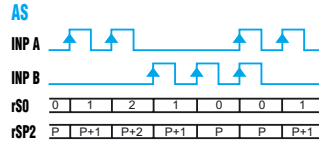

Inp A: Add. counter input 1
 Inp B: Sub. counter input 2
 rS0: Display 0 → Preset
 rSP2: Display Preset → 0

Chronometer: Start tcCbb

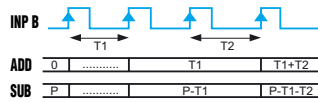

Inp A: No function
 Inp B: On/Off
 RS0/RSP2
 Add: Display 0 → Preset
 Sub: Display Preset → 0

Output operation 1: rSA0

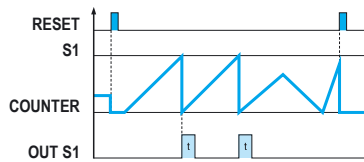

Output operation 2: rS0

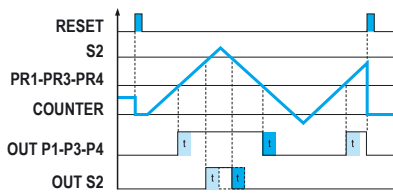

Output operation 2: rSAP2

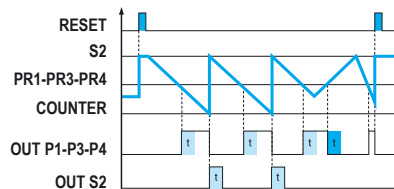

Counter: PP

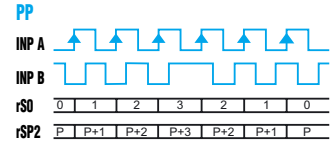

A 90° B
 Inp A: Counter input
 Counting on an edge
 Inp B: Reversal of direction
 rS0: Display 0 → Preset
 rSP2: Display Preset → 0

Chronometer: Start FrErun

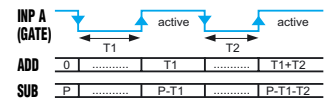

InpA: Gate
 Time measurement via InpA
 InpB: No function

Output operation 1: rSP2

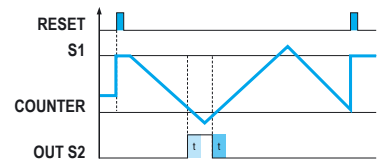

Output operation 2: rSA0

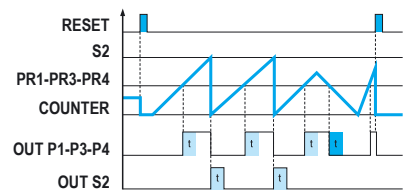

Данный компонент на территории Российской Федерации

Вы можете приобрести в компании MosChip.

Для оперативного оформления запроса Вам необходимо перейти по данной ссылке:

<http://moschip.ru/get-element>

Вы можете разместить у нас заказ для любого Вашего проекта, будь то серийное производство или разработка единичного прибора.

В нашем ассортименте представлены ведущие мировые производители активных и пассивных электронных компонентов.

Нашей специализацией является поставка электронной компонентной базы двойного назначения, продукции таких производителей как XILINX, Intel (ex.ALTERA), Vicor, Microchip, Texas Instruments, Analog Devices, Mini-Circuits, Amphenol, Glenair.

Сотрудничество с глобальными дистрибьюторами электронных компонентов, предоставляет возможность заказывать и получать с международных складов практически любой перечень компонентов в оптимальные для Вас сроки.

На всех этапах разработки и производства наши партнеры могут получить квалифицированную поддержку опытных инженеров.

Система менеджмента качества компании отвечает требованиям в соответствии с ГОСТ Р ИСО 9001, ГОСТ РВ 0015-002 и ЭС РД 009

Офис по работе с юридическими лицами:

105318, г.Москва, ул.Щербаковская д.3, офис 1107, 1118, ДЦ «Щербаковский»

Телефон: +7 495 668-12-70 (многоканальный)

Факс: +7 495 668-12-70 (доб.304)

E-mail: info@moschip.ru

Skype отдела продаж:

moschip.ru

moschip.ru_4

moschip.ru_6

moschip.ru_9