



COMMERCIAL SENSITIVE TO-5 RELAYS DPDT



SERIES	RELAY TYPE
732	DPDT basic relay
732D	DPDT relay with internal diode for coil transient suppression
732TN	DPDT relay with internal transistor driver and coil transient suppression diode

DESCRIPTION

The TO-5 relay, originally conceived and developed by Teledyne, has become one of the industry standards for low-level switching from dry circuit to 1 ampere. Designed for high-density PC board mounting, the Series 732 relays are some of the most versatile ultraminiature relays available because of their small size and low coil power dissipation.

The following unique construction features and manufacturing techniques provide excellent resistance to environmental extremes and overall high reliability:

The 732 feature:

- All welded construction.
- Unique uni-frame design providing high magnetic efficiency and mechanical rigidity.
- High force/mass ratios for resistance to shock and vibration.

- Advanced cleaning techniques provide maximum assurance of internal cleanliness.
- Precious metal alloy contact material with gold plating assures excellent high current and dry circuit switching capabilities.

The Series 732D relay has an internal discrete silicon diode for coil transient suppression. The hybrid Series 732TN relay has an internal silicon diode and transistor driver. The integrated packaging of the relay with its associated semiconductor devices greatly reduces PC board floor space requirements as well as component installation costs.

By virtue of its inherently low intercontact capacitance and contact circuit losses, the 732 has proven to be excellent ultraminiature RF switch for frequency ranges well into the UHF spectrum. A typical RF application for the TO-5 relay is in handheld radio transceivers, wherein the combined features of good RF performance, small size, low coil power dissipation and high reliability make it a preferred method of Transmit-Receive switching

Part Numbering System

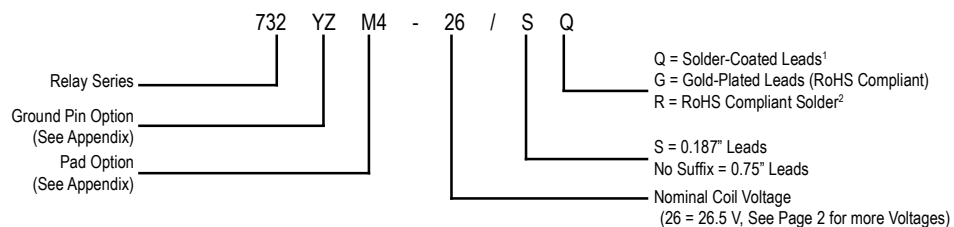

ENVIRONMENTAL AND PHYSICAL SPECIFICATIONS	
Temperature (Operating)	-55°C to +85°C
Vibration (General Note I)	10 g's to 500 Hz
Shock (General Note I)	30 g's, 6ms half sine
Enclosure	Hermetically sealed
Weight	0.09 oz. (2.55g) max.

INTERNAL CONSTRUCTION

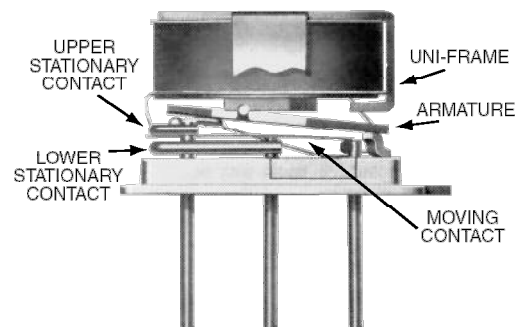

SERIES 732
GENERAL ELECTRICAL SPECIFICATIONS (@25°C)

Contact Arrangement	2 Form C (DPDT)	
Rated Duty	Continuous	
Contact Resistance	0.15 Ω max.; 0.25 Ω max. afterlife at A / 28 Vdc	
Contact Load Rating (DC)	Resistive: 1 A / 28 Vdc Inductive: 200 mA / 28 Vdc (320mH) Lamp: 100 mA / 28 Vdc (320mH) Low level: 10 to 50 μA @ 10 to 50 mV	
Contact Load Rating (AC)	Resistive: 250 mA / 115Vac, 60 and 400 Hz (Case not grounded) 100 mA / 115 Vac, 60 and 400 Hz (Case grounded)	
Contact Life Ratings	10,000,000 cycles (typical) at low level 1,000,000 cycles (typical) at 0.5 A / 28 Vdc resistive 100,000 cycles min. at all other loads specified above	
Contact Overload Rating	2 A / 28 Vdc Resistive (100 cycles min.)	
Coil Operating Power	200 mW typical at nominal rated voltage	
Contact Carry Rating	Contact Factory	
Operate Time	6.0 msec max. at nominal rated coil voltage	
Release Time	732: 3.0 ms max.	732D, 732TN: 7.5 ms max.
Intercontact Capacitance	0.4 pf typical	
Insulation Resistance	1,000 MΩ min. between mutually isolated terminals	
Dielectric Strength	350 Vrms (60 Hz) @ atmospheric pressure	
Negative Coil Transient (Vdc)	2.0 Vdc Max.	
Diode P.I.V. (Vdc)	60 Vdc Min.	
732TN Transistor Characteristics	Base Voltage to Turn Off (Vdc)	0.3 min
	Emitter-Base breakdown Voltage (BV _{EBO}) (Vdc)	6.0 min
	Collector-Base breakdown Voltage (BV _{CBO}) (Vdc)	60 min

DETAILED ELECTRICAL SPECIFICATIONS (@25°C)

BASE PART NUMBERS (732, 732D, 732TN)		732-5	732-12	732-26
		732D-5 732TN-5	732D-12 732TN-12	732D-26 732TN-26
Coil Voltage	Nom.	5.0	12.0	26.5
	Max.	7.5	20.0	40.0
Coil Resistance (Ohms ±20%)		100	850	3300
Pick-up Voltage (Vdc, Max.) Pulse Operation		3.5	9.0	18.0
732TN Base Current to Turn On (mAdc, min.)		1.5	0.47	0.24

PERFORMANCE CURVES (Note 2)

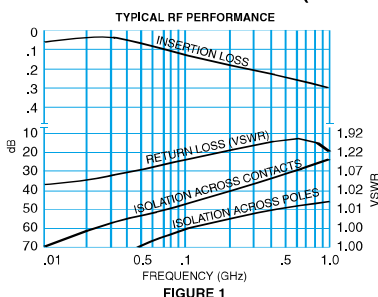

GENERAL NOTES

- Relay contacts will exhibit no chatter in excess of 10 μsec or transfer in excess of 1 μsec.
- "Typical" characteristics are based on available data and are best estimates. No on-going verification tests are performed.
- Unless otherwise specified, parameters are initial values.
- Relays can be supplied with a spacer pad. See appendix.

**SERIES 732
OUTLINE DIMENSIONS**

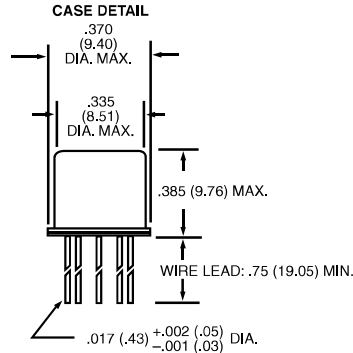

TERMINAL LOCATIONS AND PIN NUMBERING (REF. ONLY)
(Viewed from Terminals)

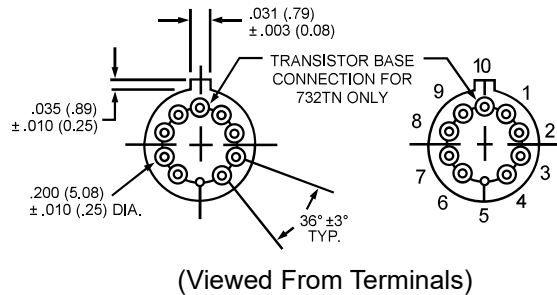

SCHEMATIC DIAGRAMS

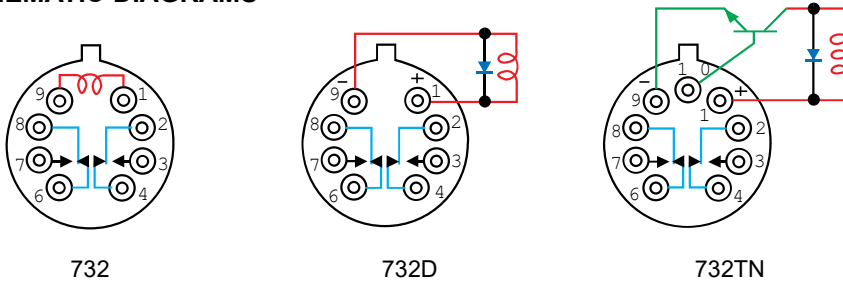

NOTES:

1. RELAY CONTACTS WILL EXHIBIT NO CHATTER IN EXCESS OF 10 MSEC OR TRANSFER IN EXCESS OF 1 MSEC.
2. "TYPICAL" CHARACTERISTICS ARE BASED ON AVAILABLE DATA AND ARE BEST ESTIMATES. NO ON-GOING VERIFICATION TESTS ARE PERFORMED.
3. UNLESS OTHERWISE SPECIFIED, PARAMETERS ARE INITIAL VALUES.
4. FOR REFERENCE ONLY. COIL RESISTANCE NOT DIRECTLY MEASURABLE ON 732TN RELAYS.
5. CIRCUIT IS TYPICAL FOR ALL SERIES 732TN. VALUES SHOWN ARE FOR 732TN-5 RELAY AND APPLY FOR FULL TEMPERATURE RANGE. LIMIT BASE-EMITTER CURRENT TO 15 MADC.
6. UNLESS OTHERWISE SPECIFIED, RELAYS WILL BE SUPPLIED WITH EITHER GOLD-PLATED OR SOLDER-COATED LEADS.
7. THE SLASH AND CHARACTERS APPEARING AFTER THE SLASH ARE NOT MARKED ON THE RELAY.

TYPICAL LOGIC INTERFACE

(See Note 5)

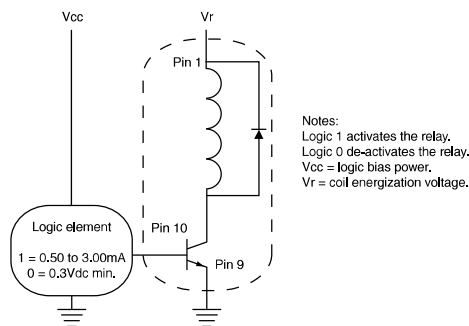

APPENDIX A : Spacer Pads

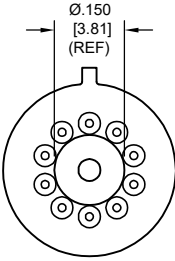
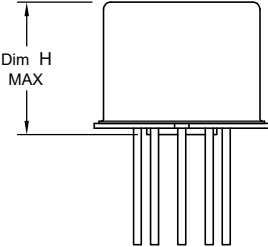
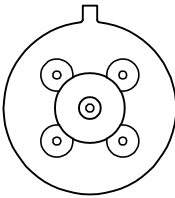
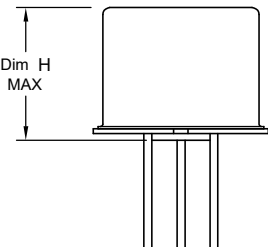
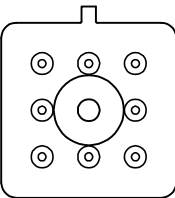
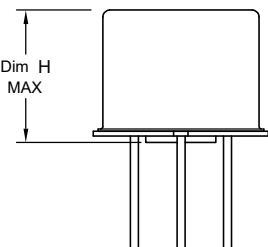
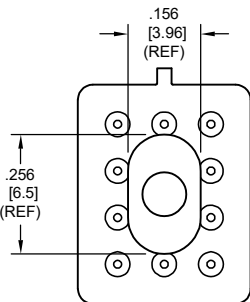
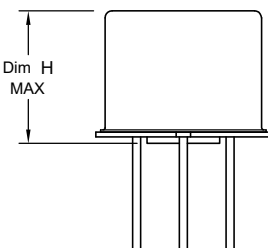
Pad designation and bottom view dimensions	Height	For use with the following:	Dim. H Max.
 <p style="text-align: center;">“M4” Pad for TO-5</p>		ER412	.295 (7.49)
		712, RF300, RF, RF700, RF703	.300 (7.62)
		ER422, 722	.305 (7.75)
		ER432	.400 (10.16)
		732, RF303	.410 (10.41)
		RF312	.350 (8.89)
 <p style="text-align: center;">“M4” Pad for TO-5</p>		ER411	.295 (7.49)
		RF311	.300 (7.62)
		RF331	.410 (10.41)
 <p style="text-align: center;">“M4” Pad for Centigrad®</p>		172	.305 (7.75)
		ER114, J114	.300 (7.62)
		ER134, J134	.400 (10.16)
		RF100	.315 (8.00)
		RF103	.420 (10.67)
 <p style="text-align: center;">“M9” Pad for Centigrad®</p>		122C, A152	.320 (8.13)
		ER116C, J116C	.300 (7.62)
		ER136C, J136C	.400 (10.16)
		RF180	.325 (8.25)
		A150	.305 (7.75)

Notes:

1. Spacer pad material: Polyester film.
2. To specify an “M4” or “M9” spacer pad, refer to the mounting variants portion of the part numbering example in the applicable datasheet.
3. Dimensions are in inches (mm).
4. Unless otherwise specified, tolerance is $\pm .010$ " (.25 mm).
5. Add 10 mΩ to the contact resistance shown in the datasheet.
6. Add 0.01 oz. (0.25 g) to the weight of the relay assembly shown in the datasheet.

APPENDIX A : Spreader Pads

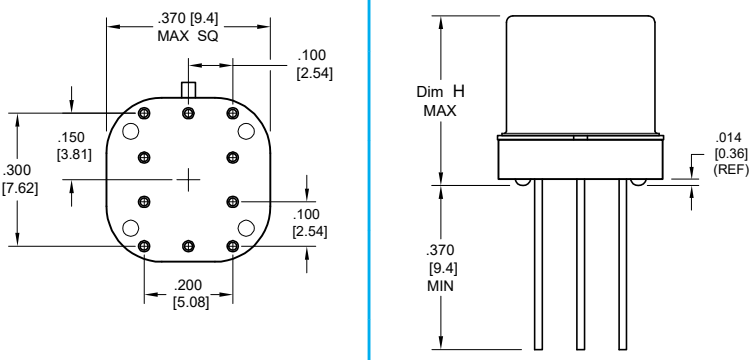
Pad designation and bottom view dimensions	Height	For use with the following:	Dim. H Max.
 <p style="text-align: center;">"M" Pad <u>5/</u> <u>6/</u></p>		ER411T, ER412, J412	.388 (9.86)
		712	.393 (9.99)
		ER432, J432	.493 (12.52)
		732	.503 (12.78)
		J421, J422, ER422, 722	.398 (10.11)

Notes:

1. Spreader pad material: Diallyl Phthalate.
2. To specify an "M", "M2" or "M3" spreader pad, refer to the mounting variants portion of the part number example in the applicable datasheet.
3. Dimensions are in inches (mm).
4. Unless otherwise specified, tolerance is $\pm .010$ " (0.25 mm).
- 5/. Add 25 m Ω to the contact resistance shown in the datasheet.
- 6/. Add .01 oz. (0.25 g) to the weight of the relay assembly shown in the datasheet.
- 7/. Add 50 m Ω to the contact resistance shown in the datasheet.
- 8/. Add 0.025 oz (0.71 g) to the weight of the relay assembly shown in the datasheet.
- 9/. M3 pad to be used only when the relay has a center pin (e.g. ER411M3-12A, 722XM3-26.)

APPENDIX A : Ground Pin Positions



TO-5 Relays:

ER412, ER412T, ER422, ER432, ER432T, 712, 712TN, 400H, 400K, 400V, RF300, RF303, RF341, RF312, RF332, RF310, RF313, RF320, RF323, SI800, SI803, RF700, RF703



TO-5 Relays:

ER411, RF311, RF331

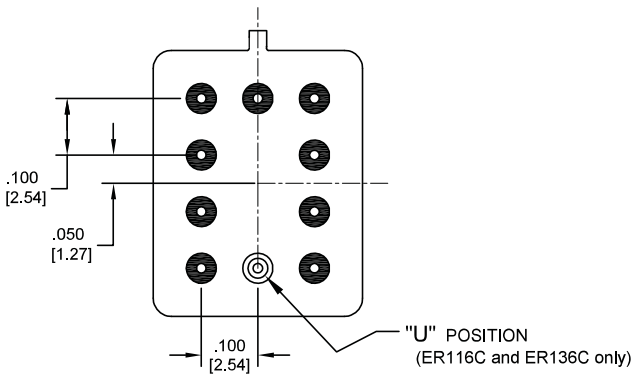

Centigrid® Relays:

RF180, ER116C, 122C, ER136C



Centigrid® Relays:

RF100, RF103, ER114, ER134, 172



Loopback Relays:

LB363

- Indicates ground pin position
- Indicates glass insulated lead position
- ⊗ Indicates ground pin or lead position depending on relay type

NOTES

1. Terminal views shown
2. Dimensions are in inches (mm)
3. Tolerances: ± .010 (±.25) unless otherwise specified
4. Ground pin positions are within .015 (0.38) dia. of true position
5. Ground pin head dia., 0.035 (0.89) ref: height 0.010 (0.25) ref.
6. Lead dia. 0.017 (0.43) nom.

Данный компонент на территории Российской Федерации

Вы можете приобрести в компании MosChip.

Для оперативного оформления запроса Вам необходимо перейти по данной ссылке:

<http://moschip.ru/get-element>

Вы можете разместить у нас заказ для любого Вашего проекта, будь то серийное производство или разработка единичного прибора.

В нашем ассортименте представлены ведущие мировые производители активных и пассивных электронных компонентов.

Нашей специализацией является поставка электронной компонентной базы двойного назначения, продукции таких производителей как XILINX, Intel (ex.ALTERA), Vicor, Microchip, Texas Instruments, Analog Devices, Mini-Circuits, Amphenol, Glenair.

Сотрудничество с глобальными дистрибьюторами электронных компонентов, предоставляет возможность заказывать и получать с международных складов практически любой перечень компонентов в оптимальные для Вас сроки.

На всех этапах разработки и производства наши партнеры могут получить квалифицированную поддержку опытных инженеров.

Система менеджмента качества компании отвечает требованиям в соответствии с ГОСТ Р ИСО 9001, ГОСТ РВ 0015-002 и ЭС РД 009

Офис по работе с юридическими лицами:

105318, г.Москва, ул.Щербаковская д.3, офис 1107, 1118, ДЦ «Щербаковский»

Телефон: +7 495 668-12-70 (многоканальный)

Факс: +7 495 668-12-70 (доб.304)

E-mail: info@moschip.ru

Skype отдела продаж:

moschip.ru

moschip.ru_4

moschip.ru_6

moschip.ru_9