

TAPE PACKING OPTIONS

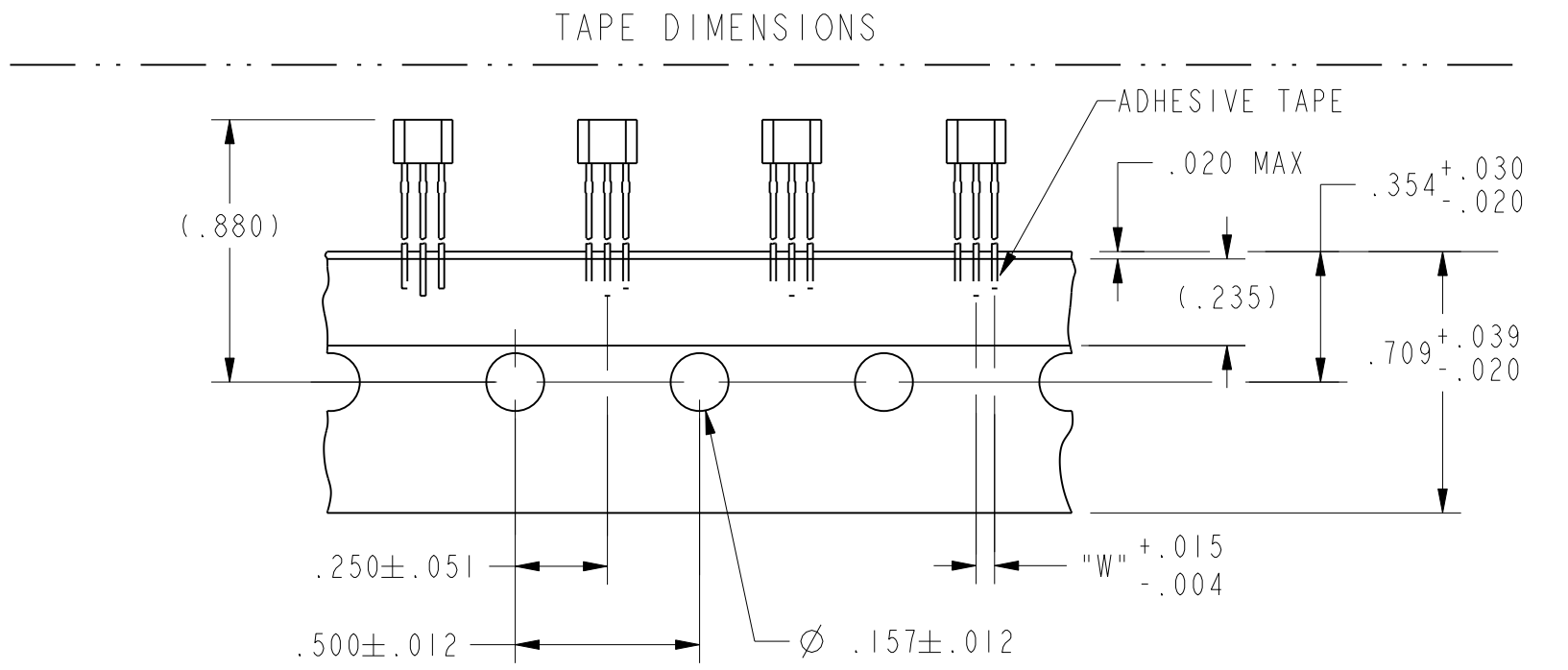

TAPE STYLE

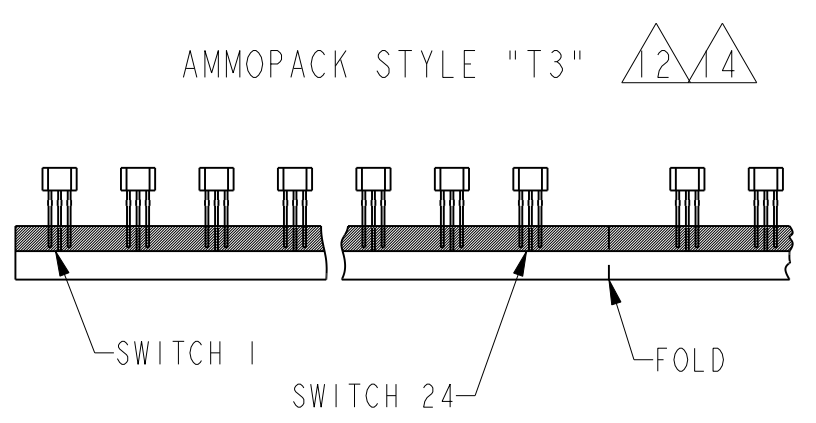
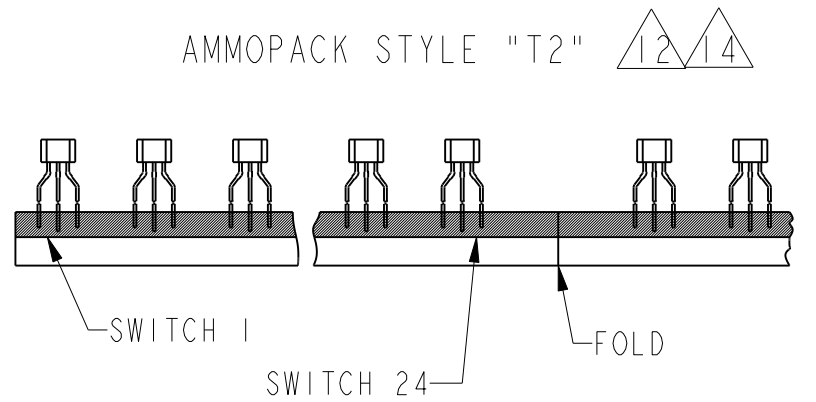

- NOTES
- 1 CENTERLINE OF HALL CELL
 - 2 THE + MAGNETIC FLUX IS IN THE DIRECTION SHOWN (THIS ASSUMES THE CONVENTION THAT THE DIRECTION OF THE EXTERNAL FLUX OF A MAGNET IS FROM THE NORTH TO THE SOUTH POLE OF THE MAGNET)
 - 3 - THE DEVICE CANNOT BE DAMAGED BY MAGNETIC OVERDRIVE
 - 4 - OUTPUT TYPE - RATIO-METRIC
 - 5 - LEADS MUST BE ADEQUATELY SUPPORTED DURING ANY FORMING/SHEERING OPERATION TO ASSURE THAT THE LEADS ARE NOT STRESSED WITHIN THE PLASTIC
 - 6 - PCB WAVE SOLDERING GUIDELINES ARE AS FOLLOWS:
250°C PEAK FOR 10 S MAX OR 260°C PEAK FOR 5 S MAX.
 - 7 BURRS ARE ALLOWED ONLY IF FULL LENGTH OF LEADS WILL PASS THROUGH ∅.023 HOLE.
 - 8 LEAD REFERENCE DIMENSIONS DO NOT INCLUDE SOLDER THICKNESS
 - 9 DIMENSION REFERS TO THE LOCATION OF LEAD CENTERLINES AS THE EXIT THE PLASTIC PACKAGE
 - 10 - SOME COMBINATIONS OF BASIC LISTING AND PACKAGE OPTIONS MAY NOT BE AVAILABLE
 - 11 ABSOLUTE MAXIMUM RATINGS ARE THE EXTREME LIMITS THE DEVICE WILL MOMENTARILY WITHSTAND WITHOUT DAMAGE TO THE DEVICE. ELECTRICAL AND MAGNETIC CHARACTERISTICS ARE NOT GUARANTEED IF THE RATED VOLTAGE AND/OR CURRENTS ARE EXCEEDED NOR WILL THE DEVICE NECESSARILY OPERATE AT ABSOLUTE MAXIMUM RATINGS
 - 12 LEAD STRAIGHTNESS MAY BE DETERIORATED ON SOME UNITS BY BULK PACKAGING. APPLICATIONS HAVING A CRITICAL LEAD STRAIGHTNESS REQUIREMENT SHOULD USE A TAPE PACKAGING OPTION
 - 13 AMMOPACK STYLE "T2" & "T3": 24 SWITCHES BETWEEN FOLDS, SKIP 1 SPACE AT FOLD. MAY BE REFERRED TO AS "FAN FOLD"
 - 14 MOLDED PART DIMENSIONS DO NOT INCLUDE FLASH. FLASH IS LIMITED TO .005 MAX
 - 15 TAPE AND AMMOPACK PER EIA-468
 - 16 POCKET TAPE PER EIA-481

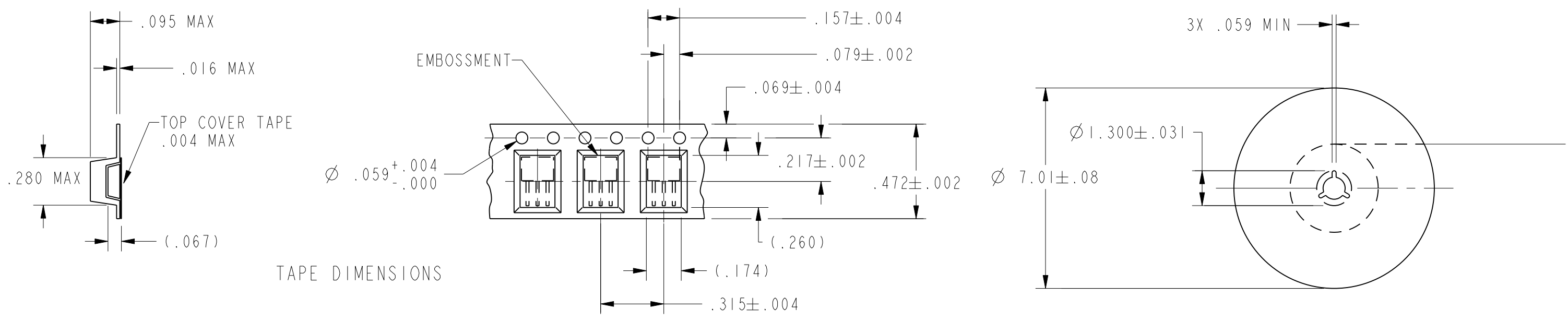

TAPE DIMENSIONS

TAPE STYLE "P"

CATALOG LISTING	TAPE STYLE	DIM "L"	DIM "W"	COMMENTS
SS495A	NONE	.590	.050	BULK - 1000/BAG
SS495A-T2	T2	.590	.100	5000/BOX
SS495A-T3	T3	.590	.050	5000/BOX
SS495A-S	NONE	.125	.050	BULK - 1000/BAG
SS495A-SP	P	.125	.050	1000/PACKET TAPE AND REEL
SS495A1	NONE	.590	.050	BULK - 1000/BAG
SS495A1-T2	T2	.590	.100	5000/BOX
SS495A1-T3	T3	.590	.050	5000/BOX
SS495A1-S	NONE	.125	.050	BULK - 1000/BAG
SS495A1-SP	P	.125	.050	1000/PACKET TAPE AND REEL
SS495A2	NONE	.590	.050	BULK - 1000/BAG
SS495A2-S	NONE	.125	.050	BULK - 1000/BAG
SS495A2-SP	P	.125	.050	1000/PACKET TAPE AND REEL
SS495A2-T2	T2	.590	.100	5000/BOX
SS495A2-T3	T3	.590	.050	5000/BOX
SS495A-L	NONE	.735	.050	BULK - 1000/BAG
SS495A1-L	NONE	.735	.050	BULK - 1000/BAG
SS495A2-L	NONE	.735	.050	BULK - 1000/BAG
SS495B	NONE	.590	.050	BULK - 1000/BAG
SS495B-T2	T2	.590	.100	5000/BOX
SS495B-T3	T3	.590	.050	5000/BOX
SS495B-S	NONE	.125	.050	BULK - 1000/BAG
SS495B-SP	P	.125	.050	1000/PACKET TAPE AND REEL

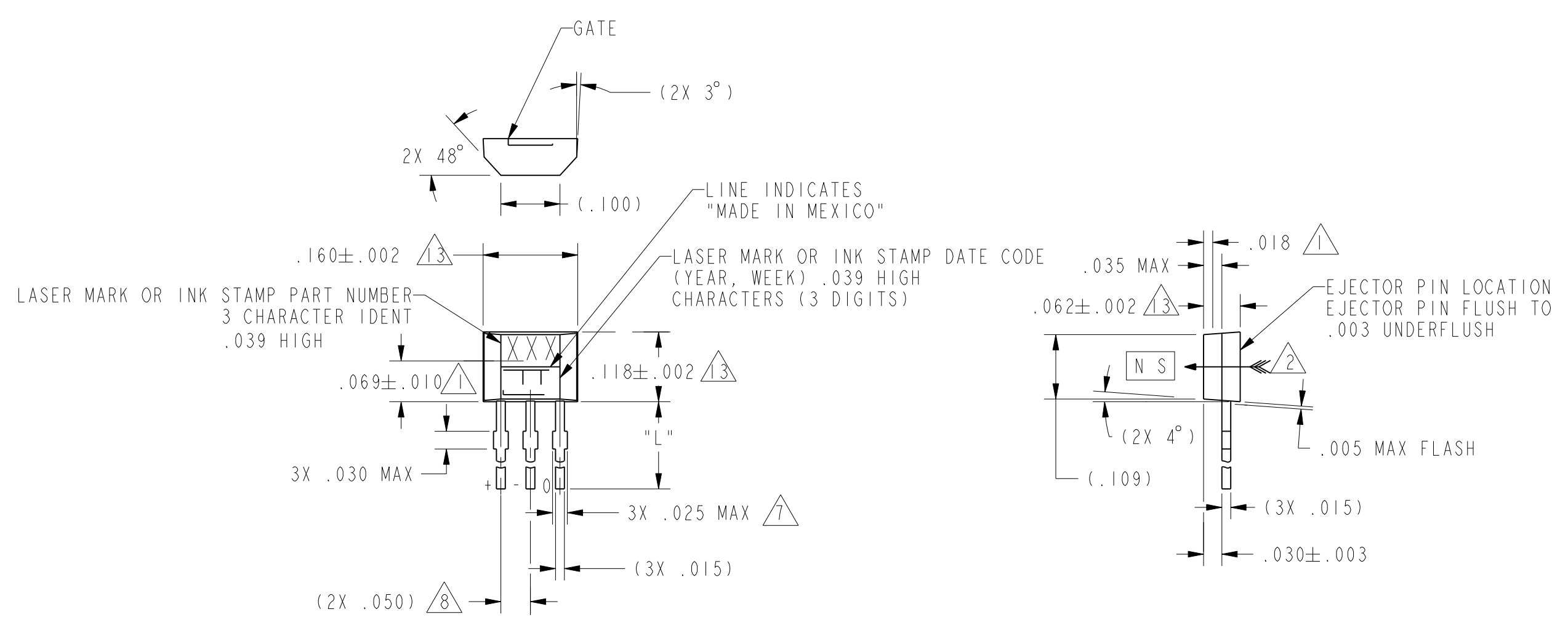

OPTIONAL SURFACE MOUNT LEAD STYLE

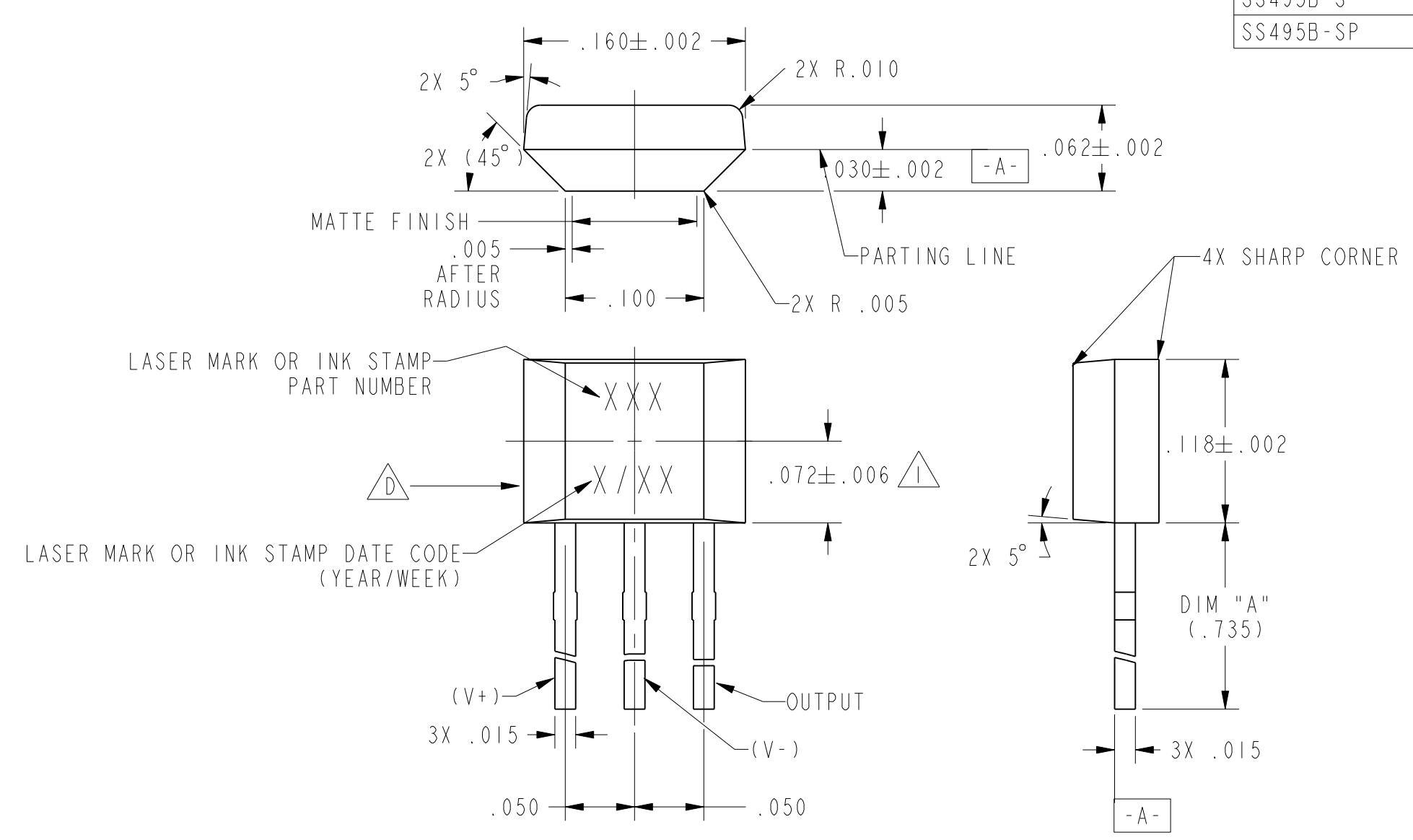
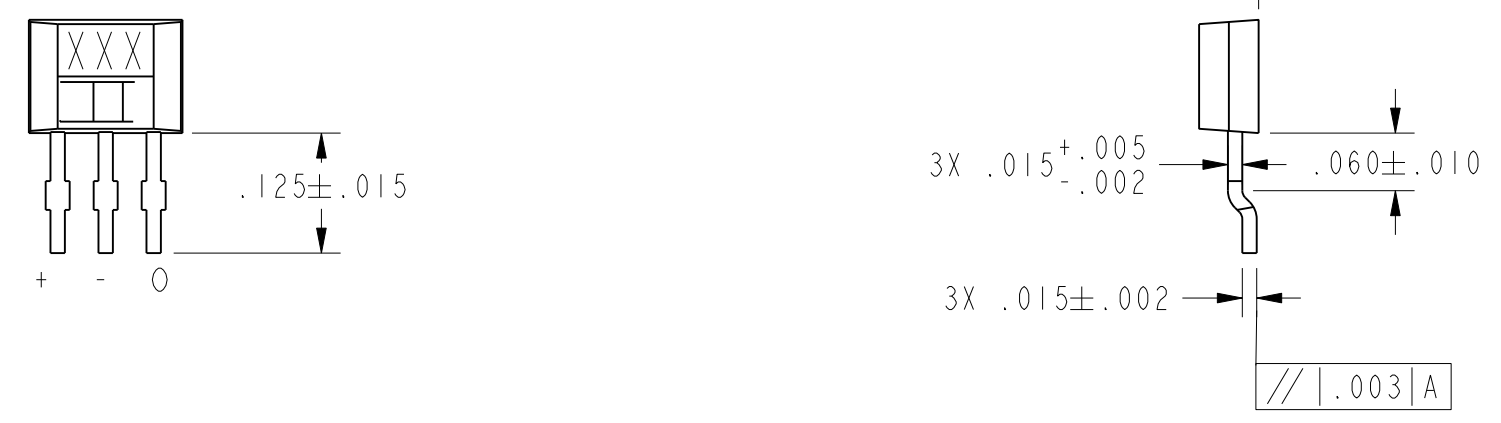

LEAD STYLES L ONLY
SCALE 10:1

PTC/CAD 2D
 DRAWING NUMBER
 ISSUE
 CHECK
 APPROVALS
 DATE
 RELEASE NO. PR-21283
 REVISIONS
 14
 1
 03/25/93
 26 OCT 01
 C.S.L. 14 APR 02
 SAV 4 APR 02
 PTC/CAD 2D
 DRAWING NUMBER
 ISSUE
 CHECK
 APPROVALS
 DATE
 RELEASE NO. PR-21283
 REVISIONS
 14
 1
 03/25/93
 26 OCT 01
 C.S.L. 14 APR 02
 SAV 4 APR 02

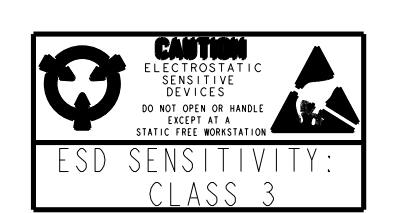

THIS DRAWING COVERS A PROPRIETARY ITEM AND IS THE PROPERTY OF MICRO SWITCH, A DIVISION OF HONEYWELL. THIS DRAWING IS NOT TO BE COPIED OR USED WITHOUT THE APPROVAL OF MICRO SWITCH.
 FED. MFG. CODE 91929
MICRO SWITCH
 a Honeywell Division
MINIATURE RATIO-METRIC LINEAR HALL EFFECT SENSOR
SS495 SERIES CHART 1

THIRD ANGLE PROJECTION

SCALE 5:1

DO NOT SCALE PRINT

UNLESS OTHERWISE SPECIFIED TOLERANCES ARE

ONE PLACE	(.0)	+.030
TWO PLACE	(.00)	+.015
THREE PLACE	(.000)	+.005

ANGLES
+2°

WEIGHT

CHARACTERISTICS ARE AT $V_s=5.0$ WITH 4.7K OUTPUT TO MINUS WITH $T_A=-40^{\circ}\text{C}$ TO $+125^{\circ}\text{C}$ UNLESS OTHERWISE SPECIFIED

SS495A

SS495 SERIES CHART 1

PARAMETER	CONDITIONS	MIN	TYP	MAX	UNITS
SENSITIVITY	$T_A = 25^{\circ}\text{C}$	3.00	3.125	3.25	mV/GAUSS
NULL	$T_A = 25^{\circ}\text{C}$	2.425	2.50	2.575	VOLTS
SUPPLY CURRENT	$T_A = 25^{\circ}\text{C}$		7	8.7	mA
OUTPUT CURRENT	SOURCE $V_s > 4.5$	1mA	1.5mA		
	SINK $V_s > 4.5$.6mA	1.5mA		
	SINK $V_s > 5.0$	1mA	1.5mA		
RESPONSE TIME			3μS		
OUTPUT VOLTAGE SWING	VOM -	.4	.2		VOLTS
	VOM +	$V_s - .4$	$V_s - .2$		VOLTS
B LIMITS FOR LINEAR OPERATION	-B MAX	-600	-670		GAUSS
	+B MAX	+600	+670		GAUSS
V_{null} DRIFT	$B = 0, T_A = 25^{\circ}\text{C TO } 125^{\circ}\text{C}$	-.06		+.06	% / °C
V_{null} DRIFT	$B = 0, T_A = -125^{\circ}\text{C TO } +150^{\circ}\text{C}$	-.08		+.08	% / °C
SENSITIVITY DRIFT	$T_A = +25^{\circ}\text{C TO } +150^{\circ}\text{C}$	-.01		+.05	% / °C
SENSITIVITY DRIFT	$T_A = -40^{\circ}\text{C TO } +25^{\circ}\text{C}$	0		+.06	% / °C
LINEARITY	$B = -600 \text{ TO } +600$	0	-1.0	-1.5	% OF SPAN
SUPPLY VOLTAGE	$-40^{\circ}\text{C TO } +125^{\circ}\text{C}$	4.5	5.0	10.5	VOLTS
OPERATING TEMP	SEE MAX TEMPERATURE CHART	-40		+150	°C

BLOCK DIAGRAM CURRENT SINKING OR SOURCING OUTPUT

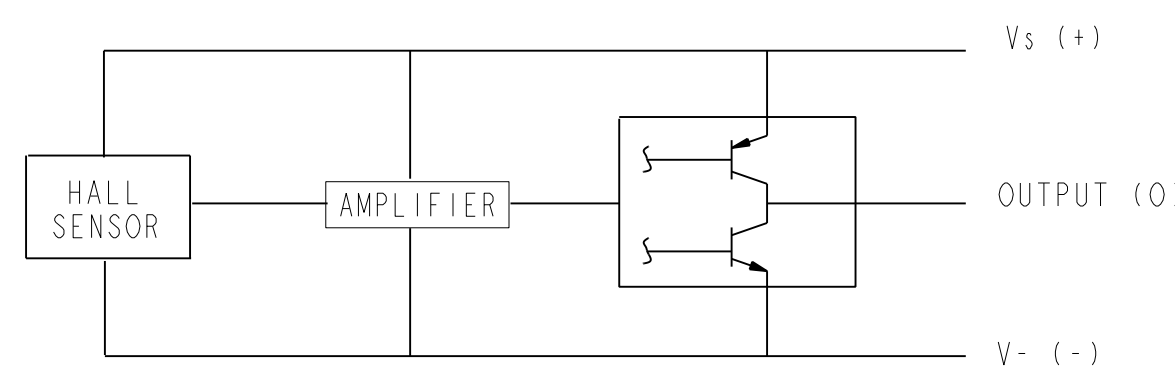

ABSOLUTE MAXIMUM CHARACTERISTICS

CHARACTERISTIC	SYMBOL	TEST CONDITION	MIN	MAX	UNITS
SUPPLY VOLTAGE	V_{cc}		-0.5	11	V
OUTPUT VOLTAGE	V_{out}		-0.5	11	V
OUTPUT CURRENT	I_{out}	SOURCE OR SINK		10	mA
TEMPERATURE	T_A	OPERATING	-55	150	°C
	T_s	STORAGE ($V_{cc}=0$)	-55	165	°C

NULL SHIFT VERSUS TEMPERATURE

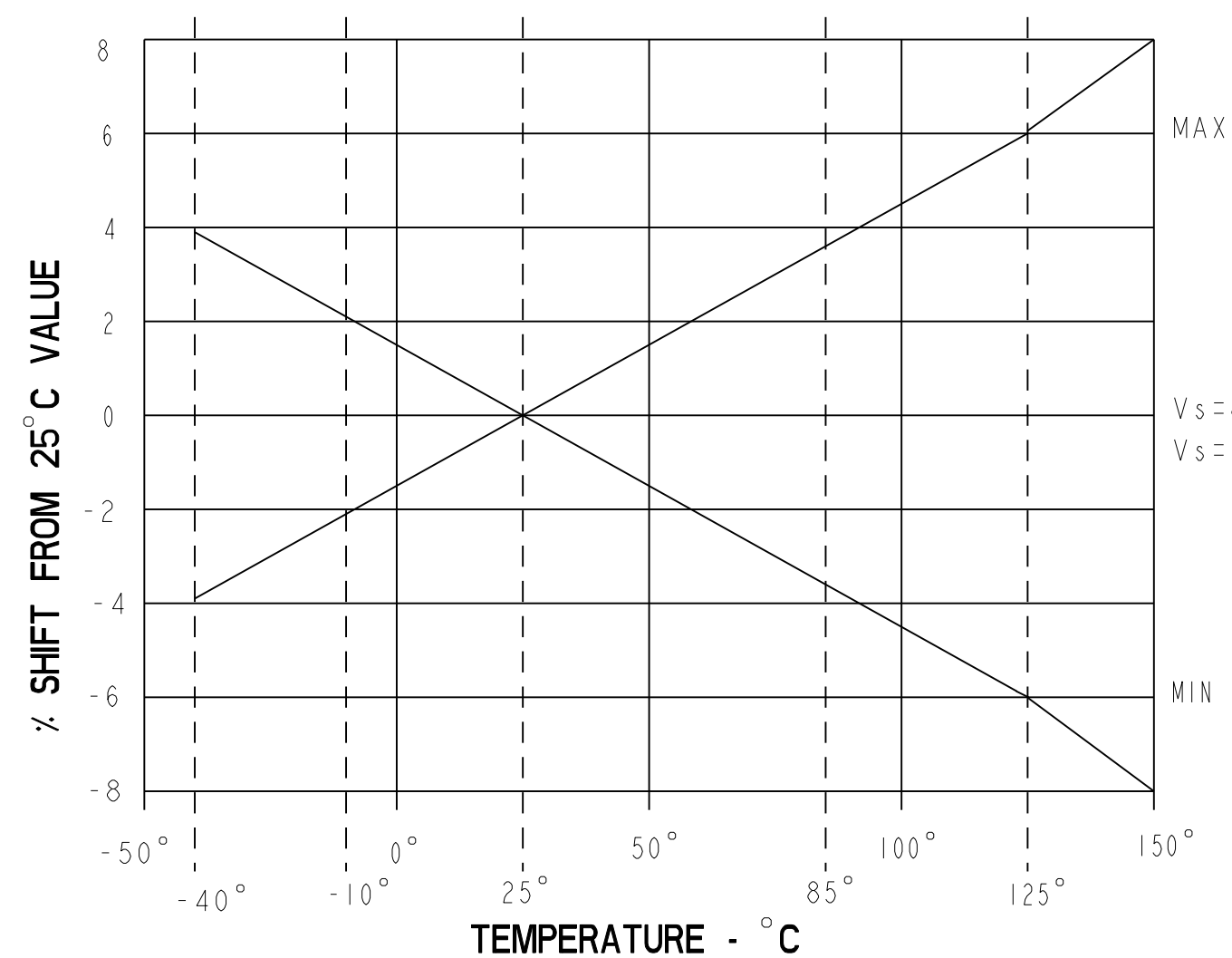

RATIO OF V_{null} TO V_s

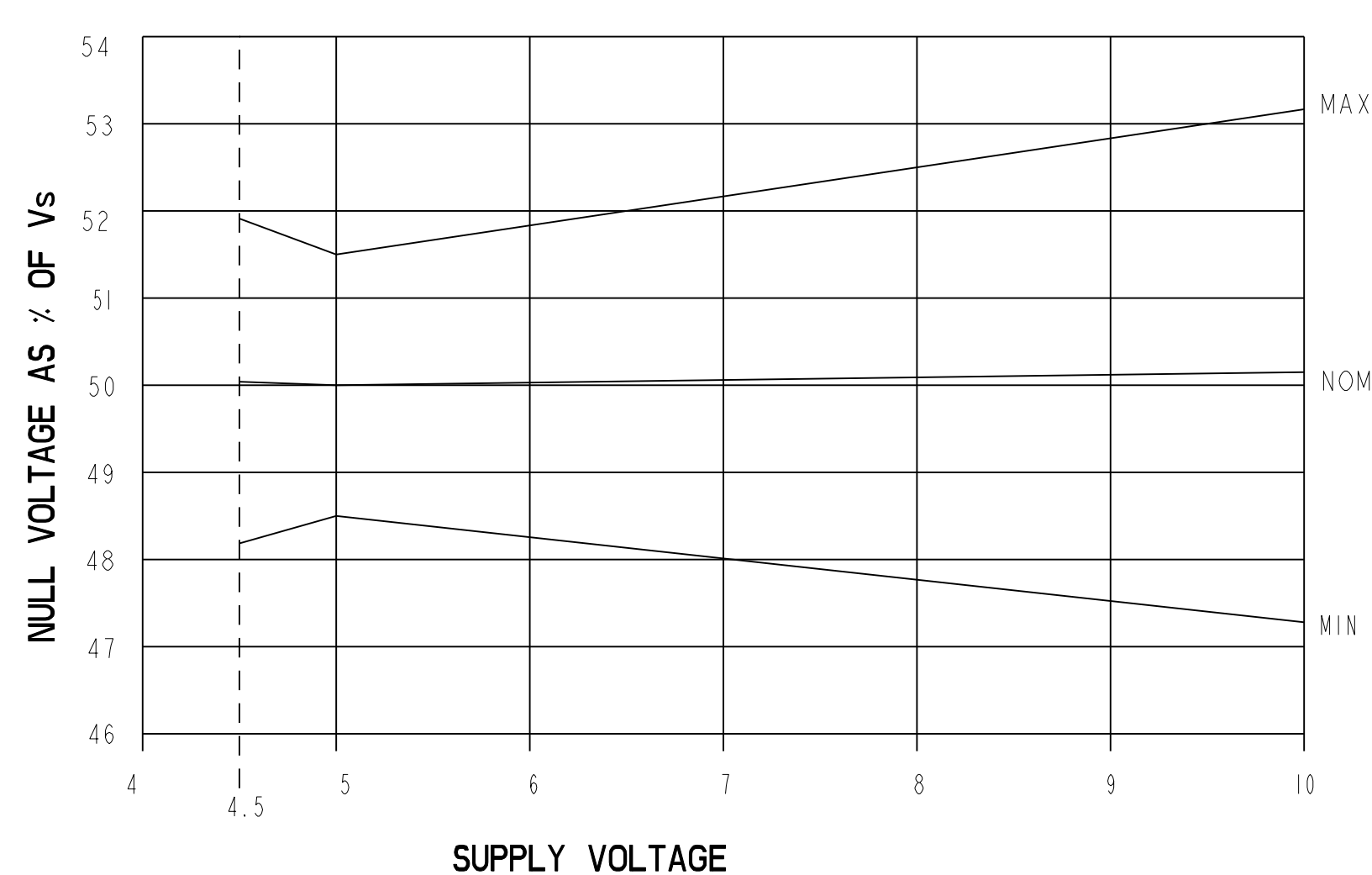

SENSITIVITY SHIFT VERSUS TEMPERATURE

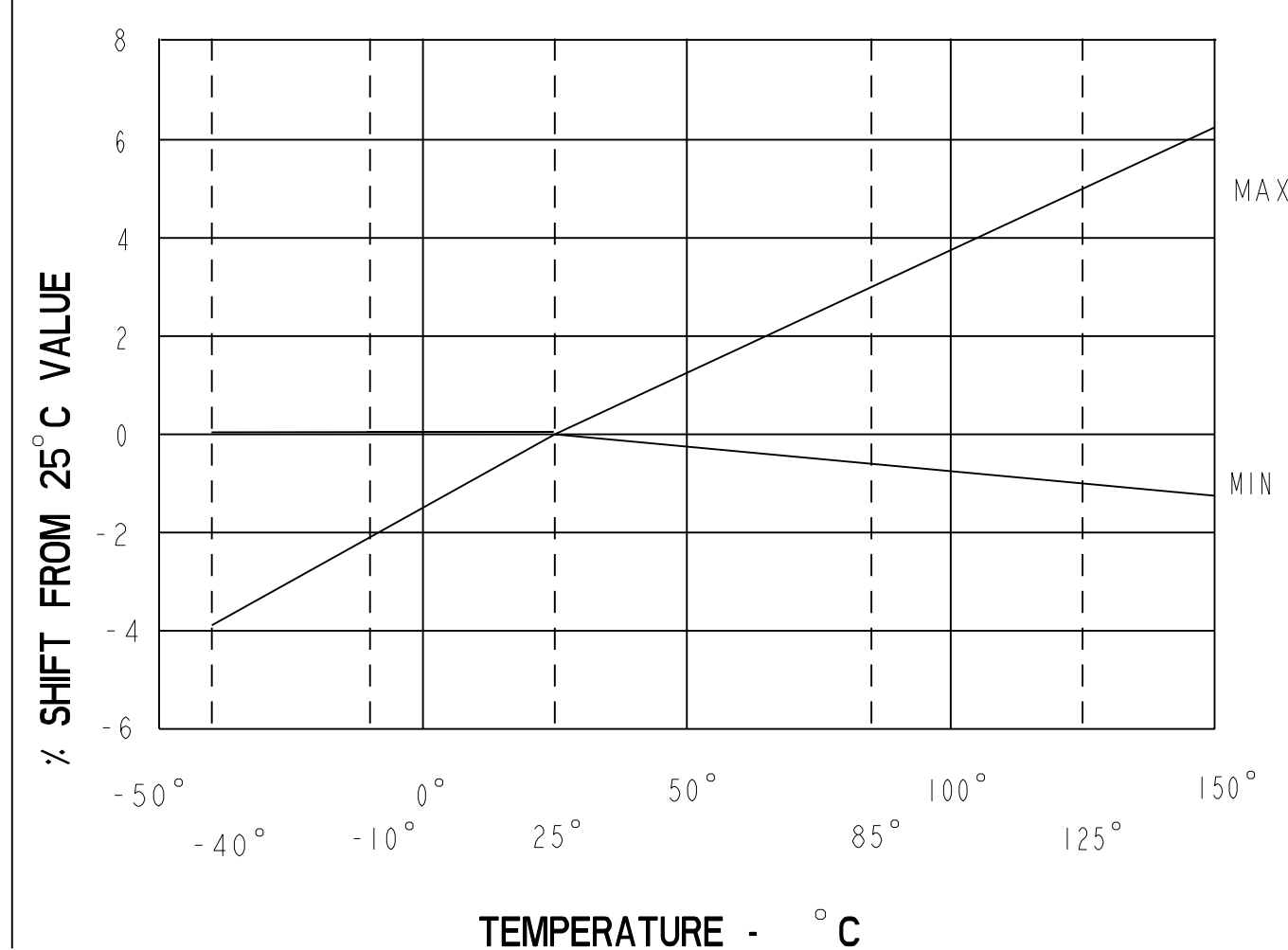

SENSITIVITY/V VERSUS V_s
(mV/GAUSS/VOLT)

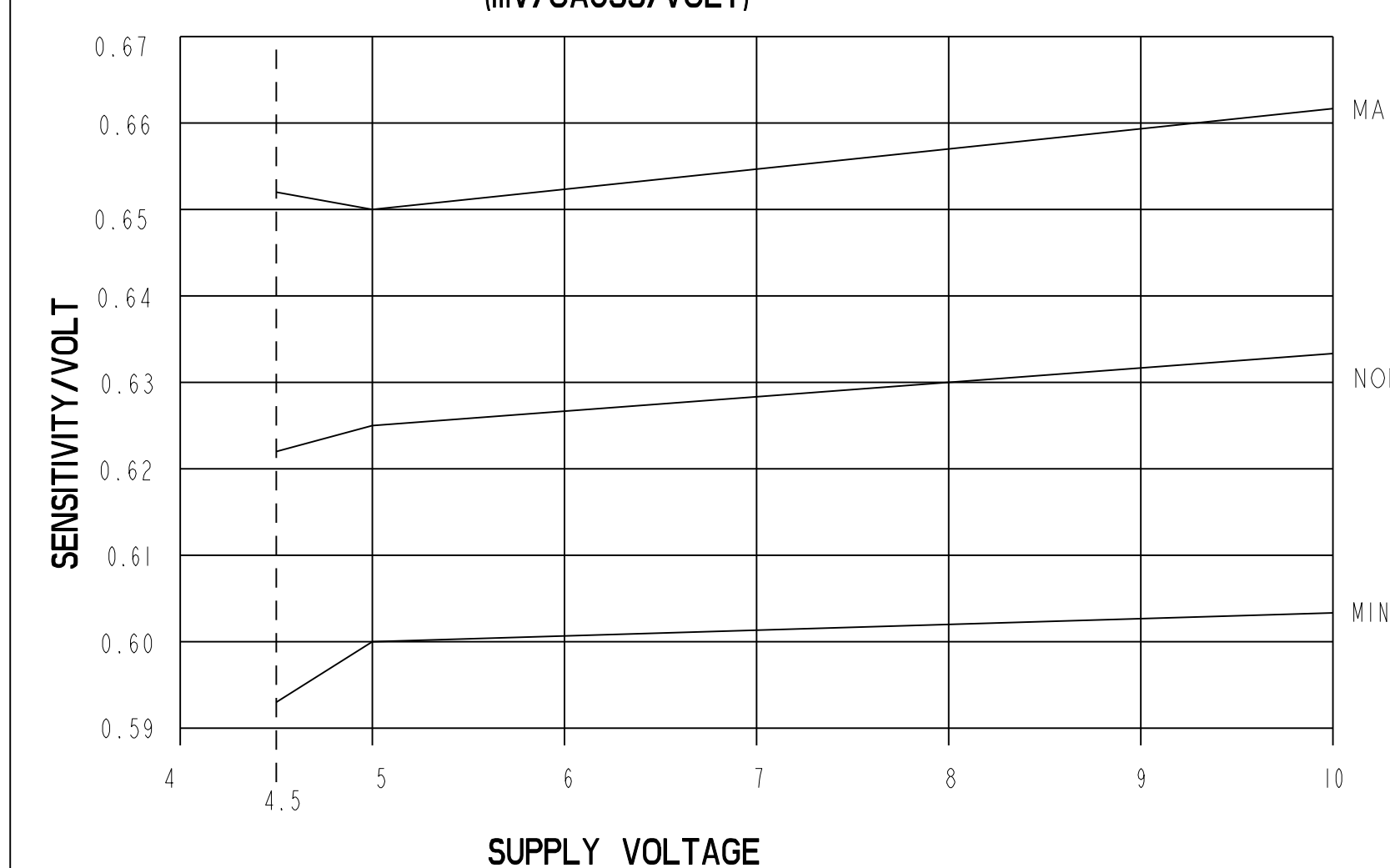

LINEARITY VERSUS V_s
END POINT OF SPAN METHOD

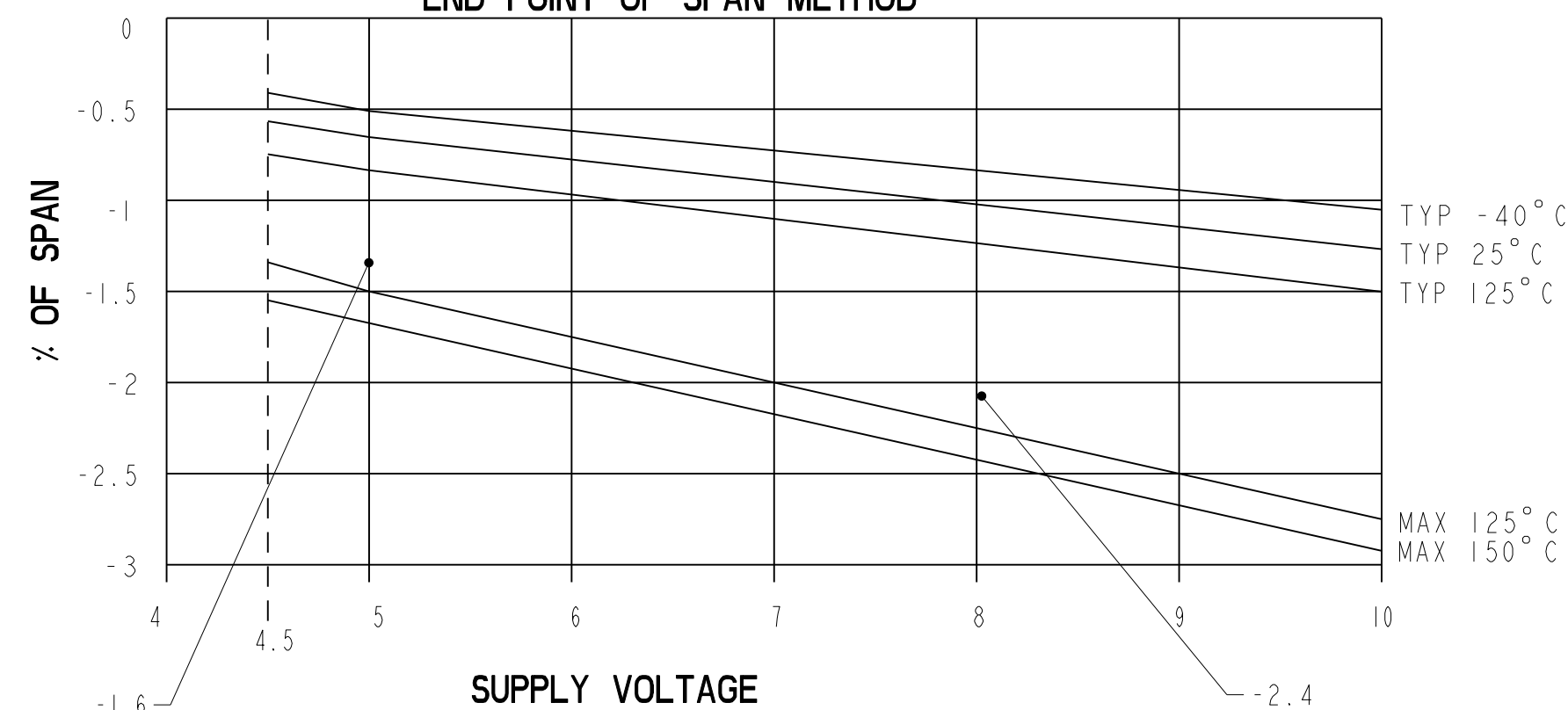

TRANSFER CHARACTERISTICS AT $V_s=5.0$ VDC

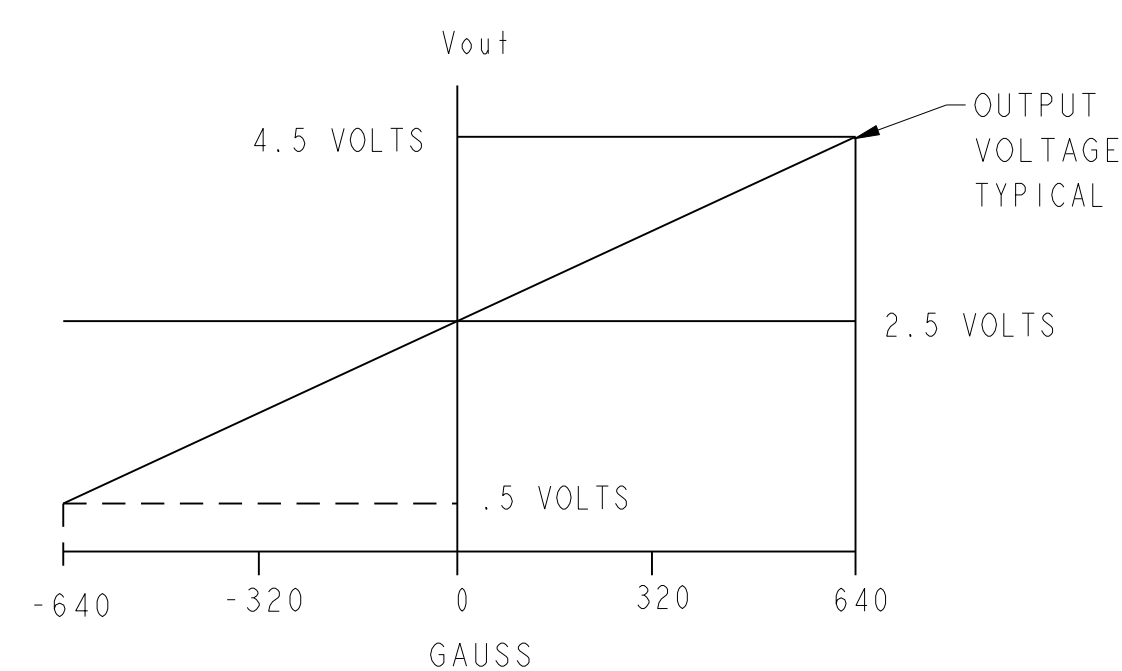

SUPPLY CURRENT VERSUS TEMPERATURE

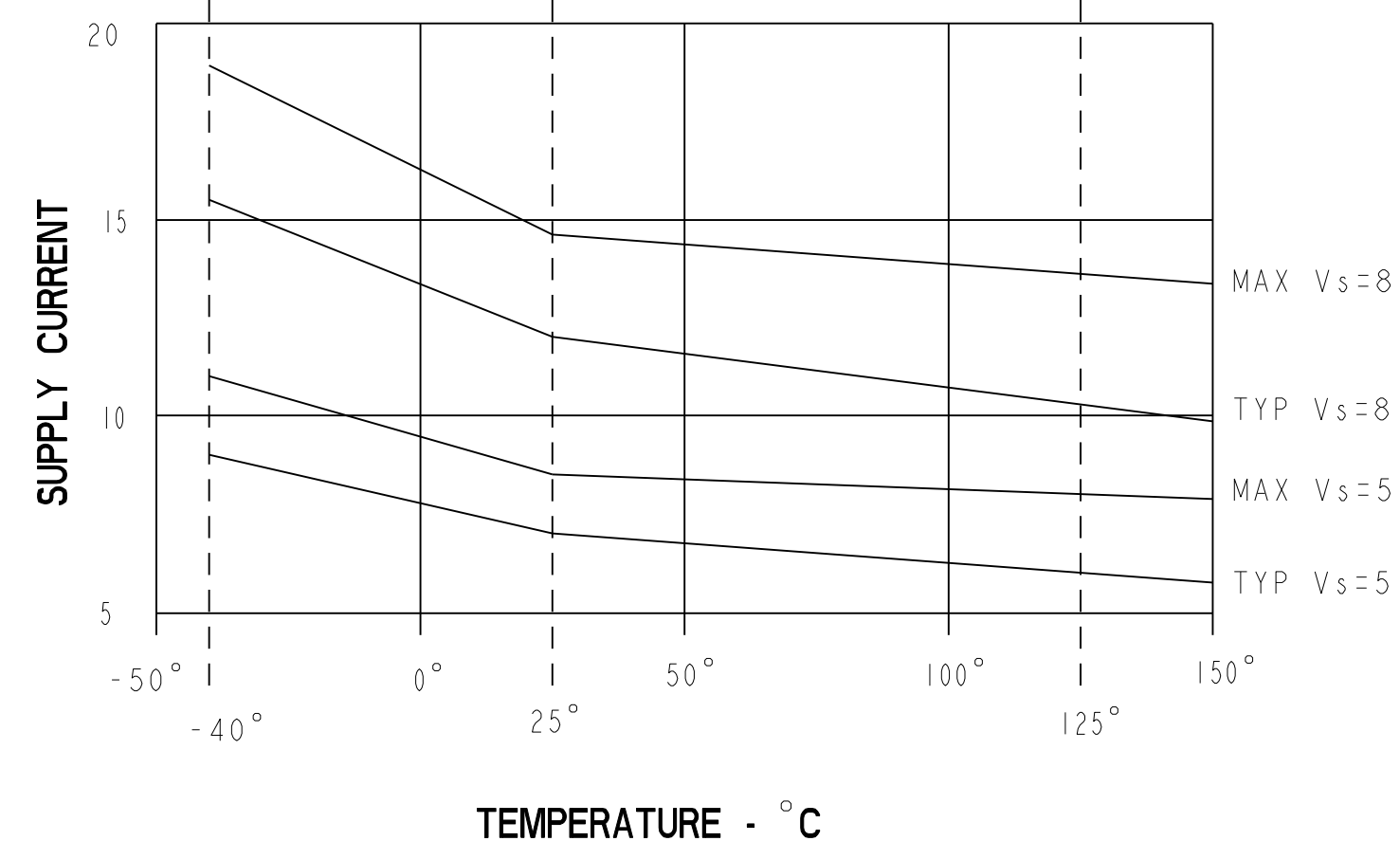

TYPICAL FREQUENCY RESPONSE
RL-33k PARALLEL WITH 100pF

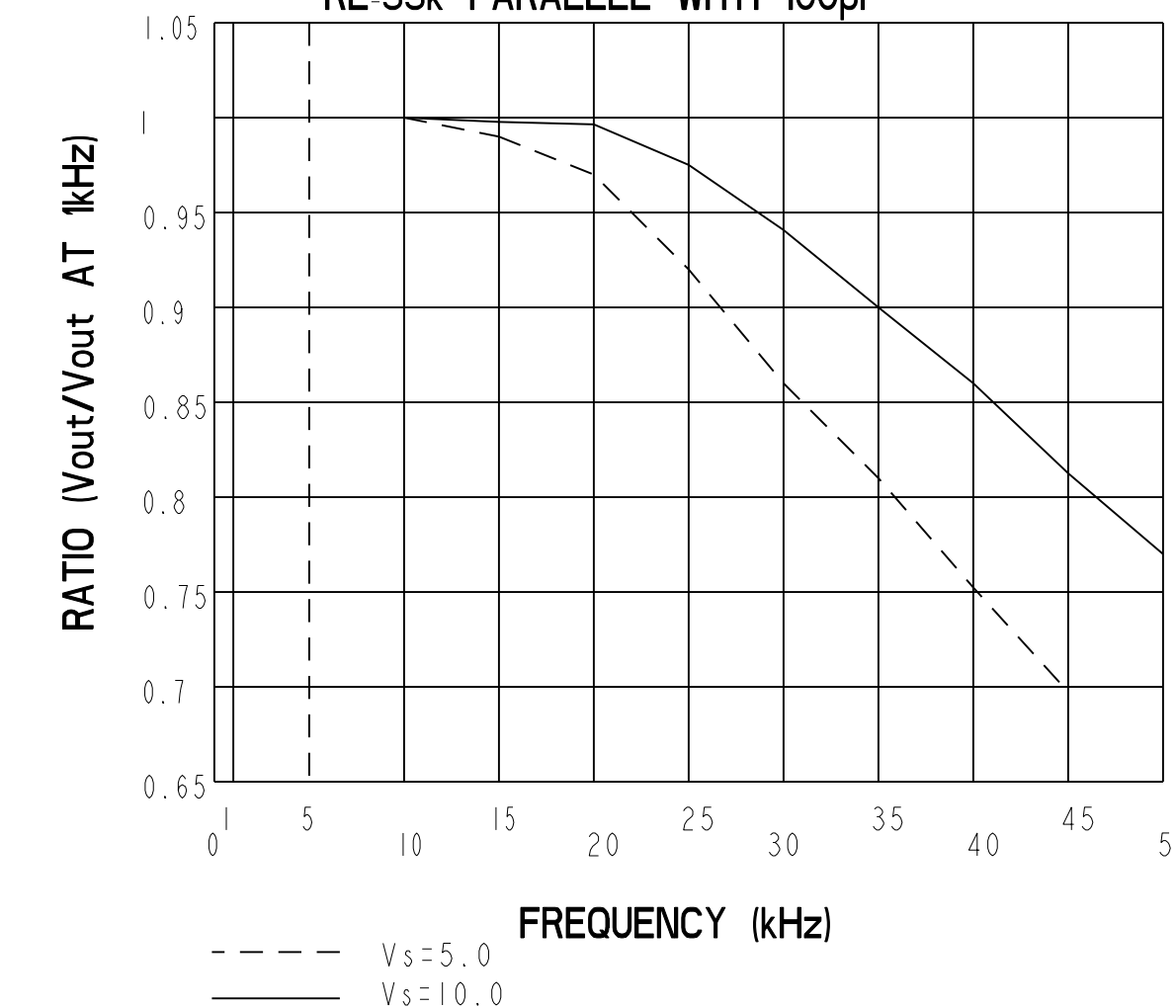

MAXIMUM ALLOWABLE AMBIENT TEMPERATURE

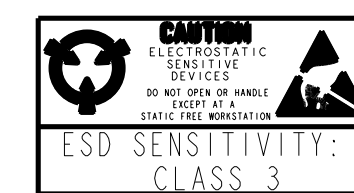
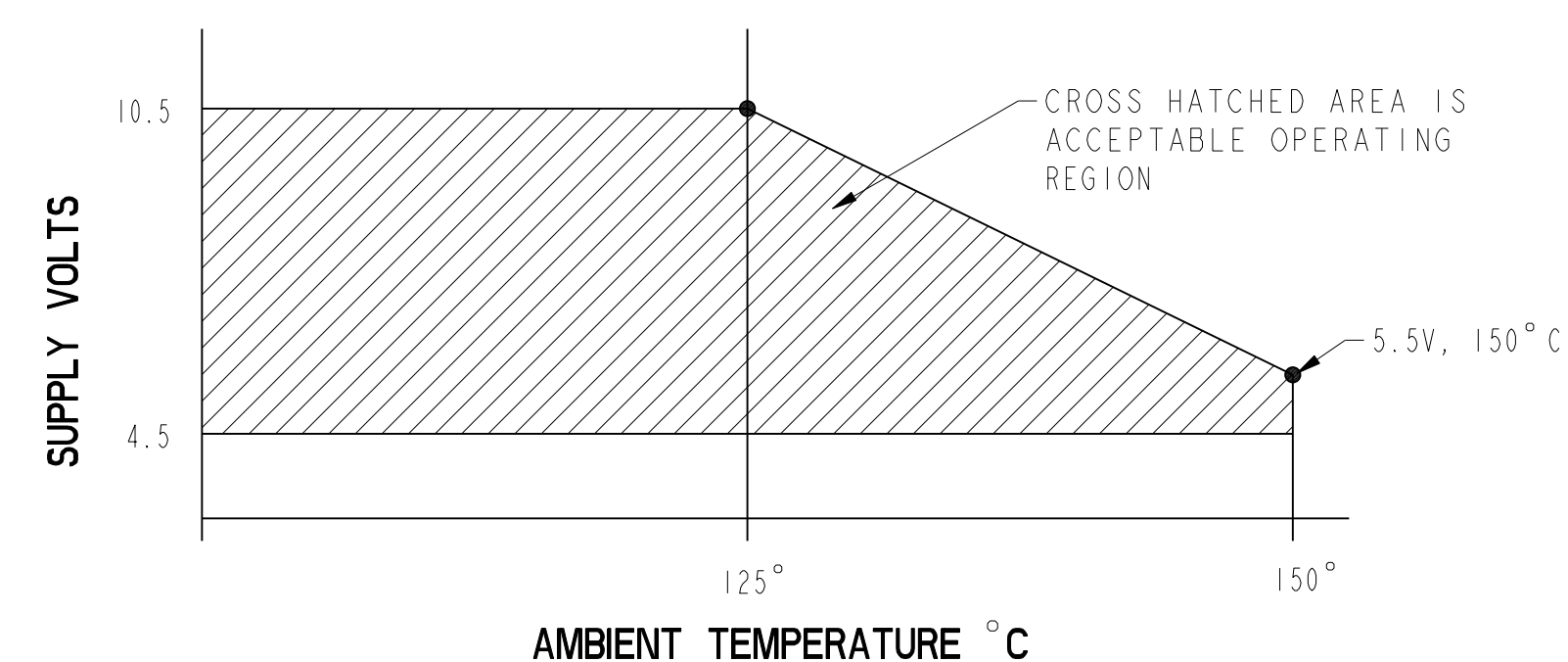

THIS DRAWING COVERS A PROPRIETARY ITEM AND IS THE PROPERTY OF MICRO SWITCH, A DIVISION OF HONEYWELL. THIS DRAWING IS NOT TO BE COPIED OR USED WITHOUT THE APPROVAL OF MICRO SWITCH.
FED. MFG. CODE 91929
MICRO SWITCH a Honeywell Division
MINIATURE RATIO-METRIC LINEAR HALL EFFECT SENSOR
SS495 SERIES CHART 1

THIRD ANGLE PROJECTION	SCALE	DO NOT SCALE PRINT
SCALE: NONE	UNLESS OTHERWISE SPECIFIED TOLERANCES ARE	ONE PLACE (.0) +.030
		TWO PLACE (.00) +.015
		THREE PLACE (.000) +.005
		ANGLES +2°
	WEIGHT	

ANSI Y14.5M-1982 APPLIES

PTC/CAD 2D
 DRAWN: C.S.L.
 CHECK: L.A.
 APPROVED: S.A.V.
 DATE: 4 APR 02
 RELEASE NO. PR-21283
 REVISIONS:
 14
 ISSUE: 14
 DRAWING NUMBER: 14
 DRAWING TITLE: SS495 SERIES CHART 1
 DRAWING SCALE: 1:1
 DRAWING SHEET: 2 OF 5
 DRAWING DATE: 26 OCT 01

CHARACTERISTICS ARE AT $V_s=5.00$ WITH 4.7K OUTPUT TO MINUS WITH $T_A = -40^\circ\text{C}$ TO $+125^\circ\text{C}$ UNLESS OTHERWISE SPECIFIED

SS495A1

SS495 SERIES CHART 1

PARAMETER	CONDITIONS	MIN	TYP	MAX	UNITS
SENSITIVITY	$T_A = 25^\circ\text{C}$	3.031	3.125	3.219	mV/GAUSS
NULL	$T_A = 25^\circ\text{C}$	2.425	2.50	2.575	VOLTS
SUPPLY CURRENT	$T_A = 25^\circ\text{C}$		7	8.7	mA
OUTPUT CURRENT SOURCE	$V_s > 4.5$	1mA	1.5mA		
	SINK	$V_s > 4.5$.6mA	1.5mA	
	SINK	$V_s > 5.0$	1mA	1.5mA	
RESPONSE TIME			3 μs		
OUTPUT VOLTAGE SWING	VOM -		.4	.2	VOLTS
	VOM +	+B APPLIED	$V_s - .4$	$V_s - .2$	VOLTS
B LIMITS FOR LINEAR OPERATION	-B MAX	-600	-670		GAUSS
	+B MAX	+600	+670		GAUSS
V_{null} DRIFT	$B = 0, T_A = 25^\circ\text{C}$ TO 125°C	-.04		+.04	% / $^\circ\text{C}$
V_{null} DRIFT	$B = 0, T_A = +125^\circ\text{C}$ TO $+150^\circ\text{C}$	-.08		+.08	% / $^\circ\text{C}$
SENSITIVITY DRIFT	$T_A = +25^\circ\text{C}$ TO $+150^\circ\text{C}$	-.01		+.05	% / $^\circ\text{C}$
SENSITIVITY DRIFT	$T_A = -40^\circ\text{C}$ TO $+25^\circ\text{C}$	0		+.06	% / $^\circ\text{C}$
LINEARITY	$B = -600$ TO $+600$	0	-1.0	-1.5	% OF SPAN
SUPPLY VOLTAGE	-40°C TO $+125^\circ\text{C}$	4.5	5.0	10.5	VOLTS
OPERATING TEMP	SEE MAX TEMPERATURE CHART	-40		+150	$^\circ\text{C}$

BLOCK DIAGRAM CURRENT SINKING OR SOURCING OUTPUT

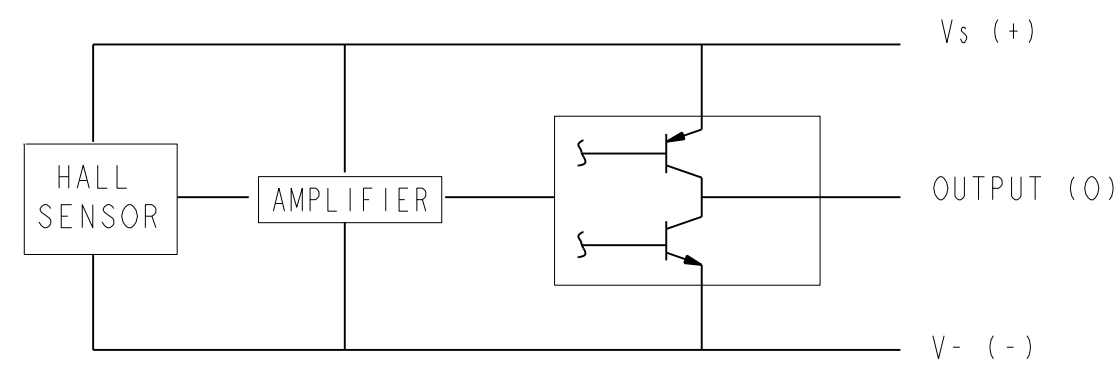

ABSOLUTE MAXIMUM CHARACTERISTICS

CHARACTERISTIC	SYMBOL	TEST CONDITION	MIN	MAX	UNITS
SUPPLY VOLTAGE	V_{cc}		-0.5	11	V
OUTPUT VOLTAGE	V_{out}		-0.5	11	V
OUTPUT CURRENT	I_{out}	SOURCE OR SINK		10	mA
TEMPERATURE	T_A	OPERATING	-55	150	$^\circ\text{C}$
	T_s	STORAGE ($V_{cc}=0$)	-55	165	$^\circ\text{C}$

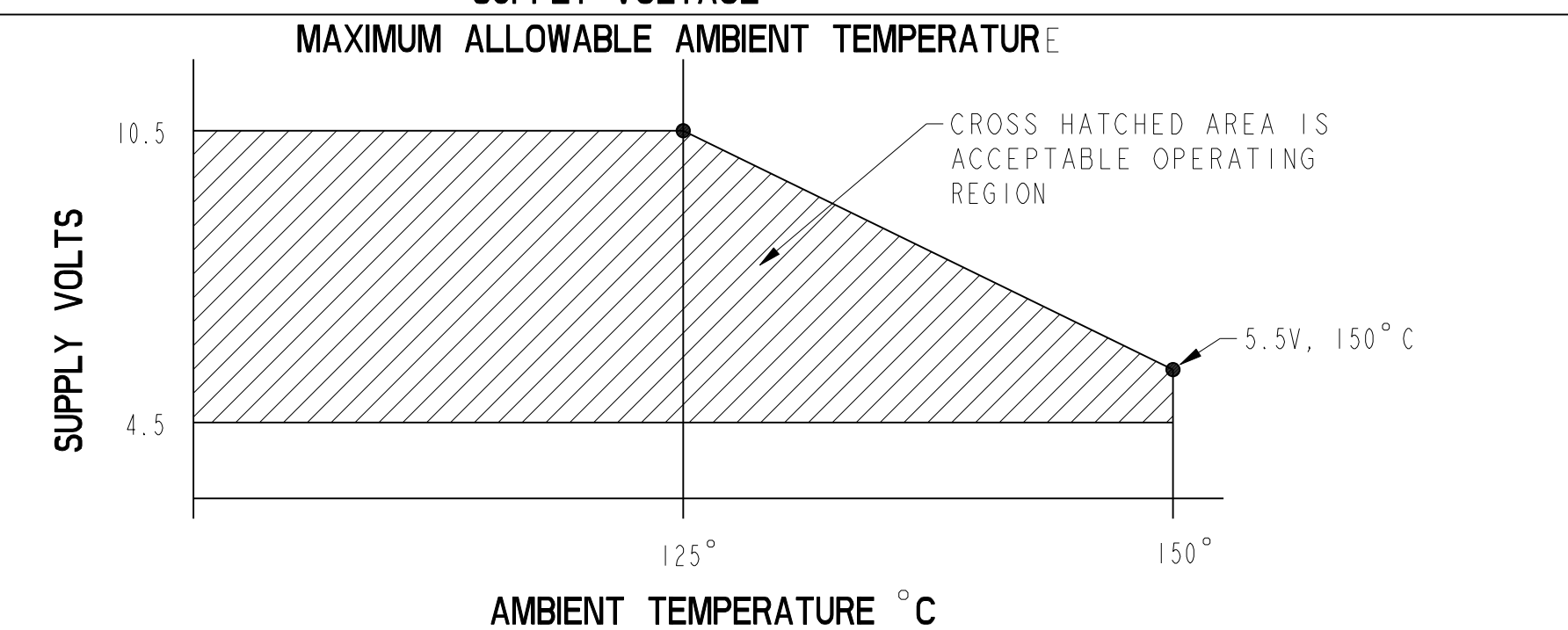
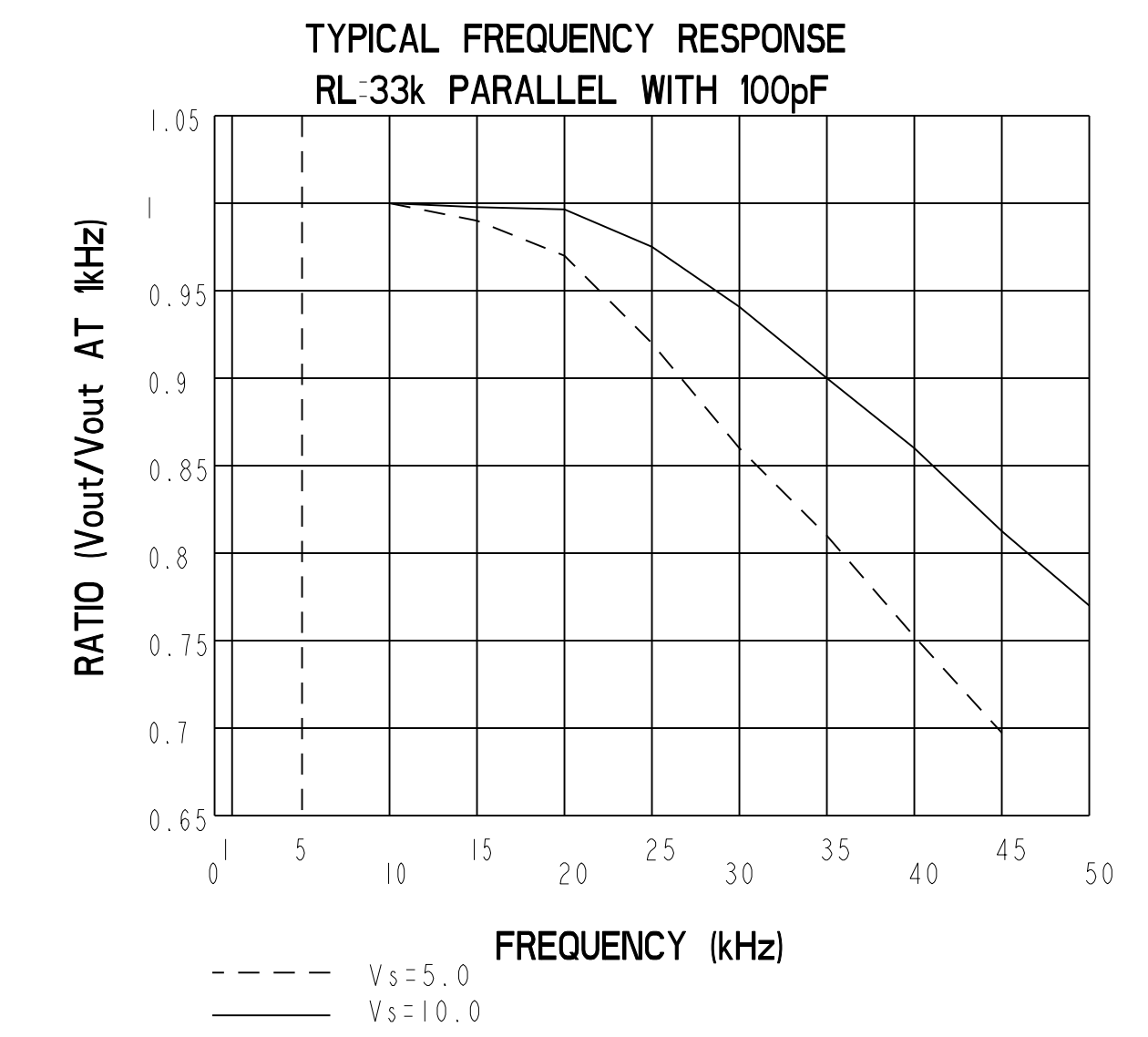
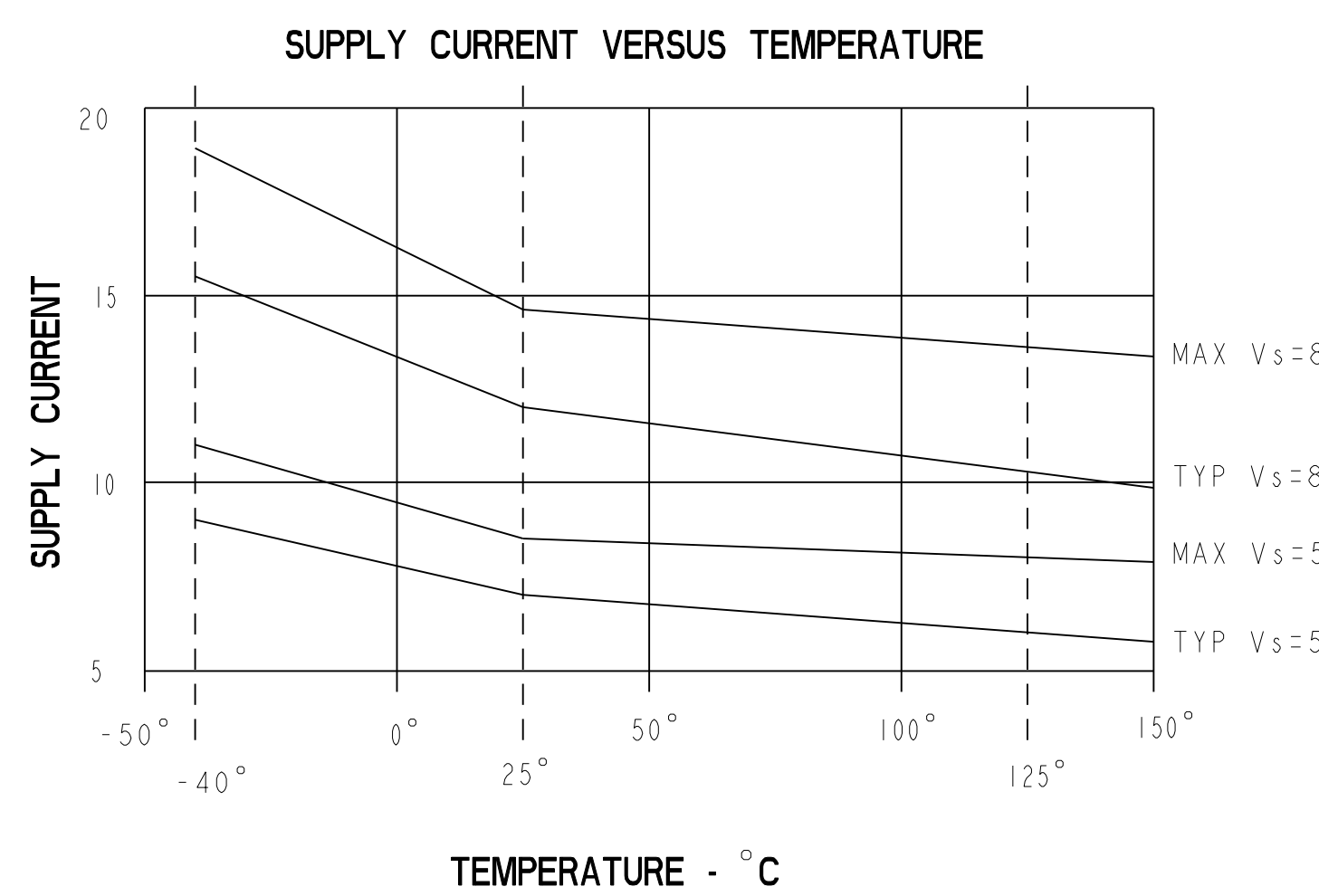
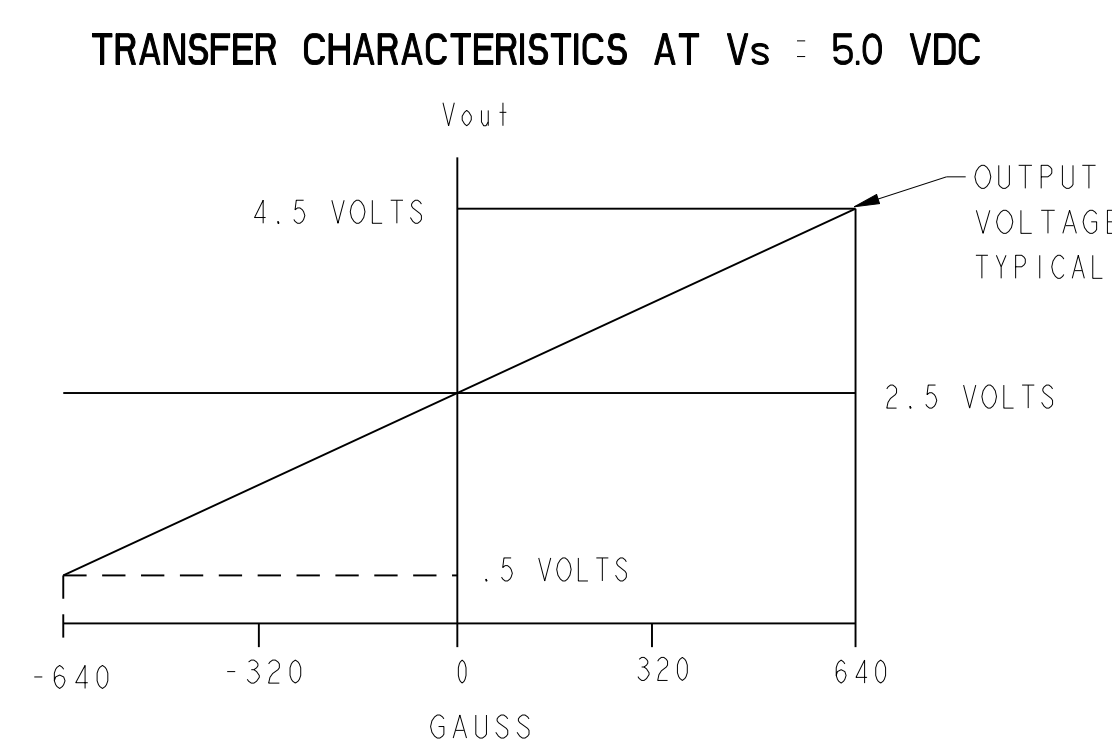
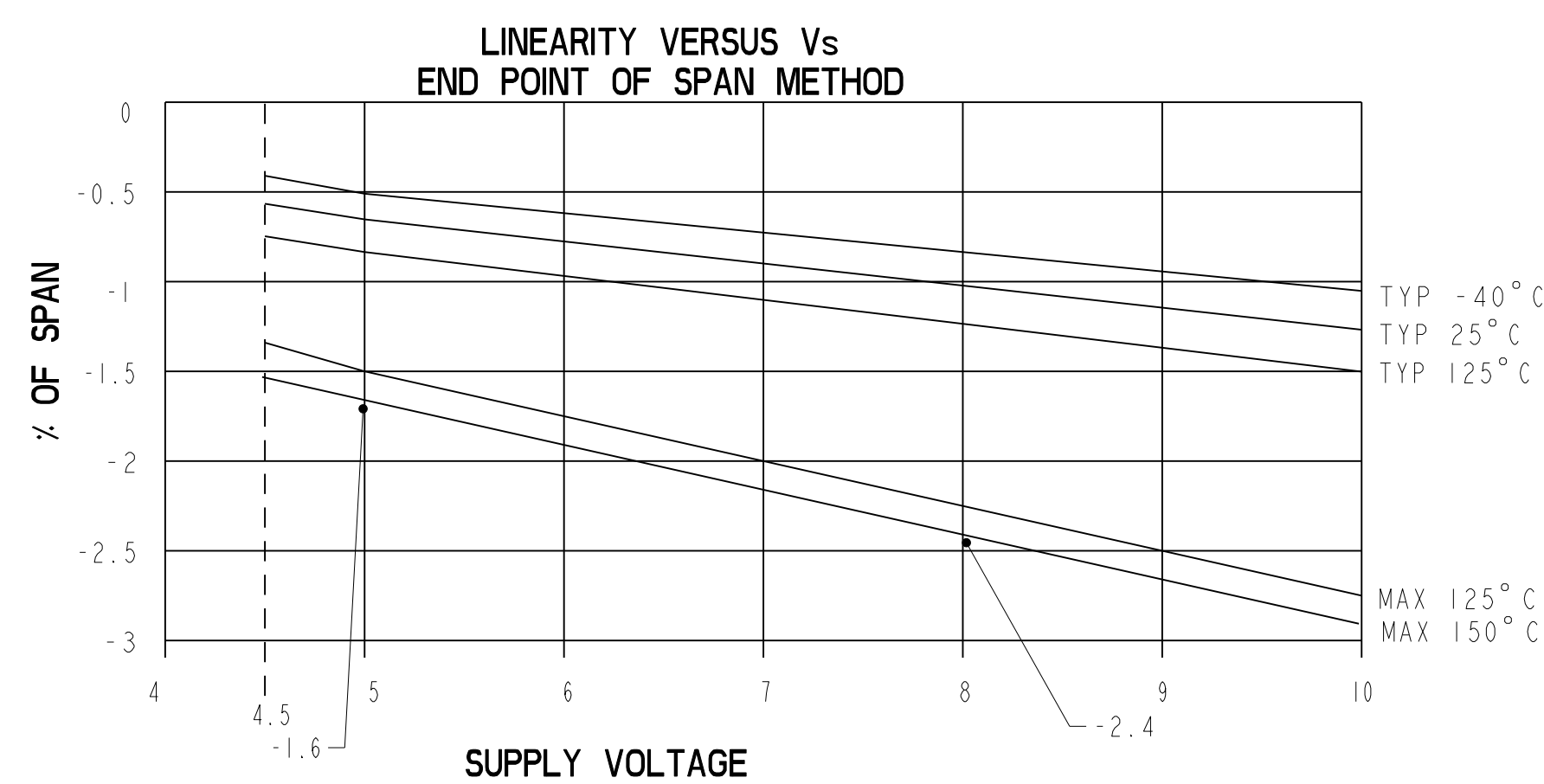
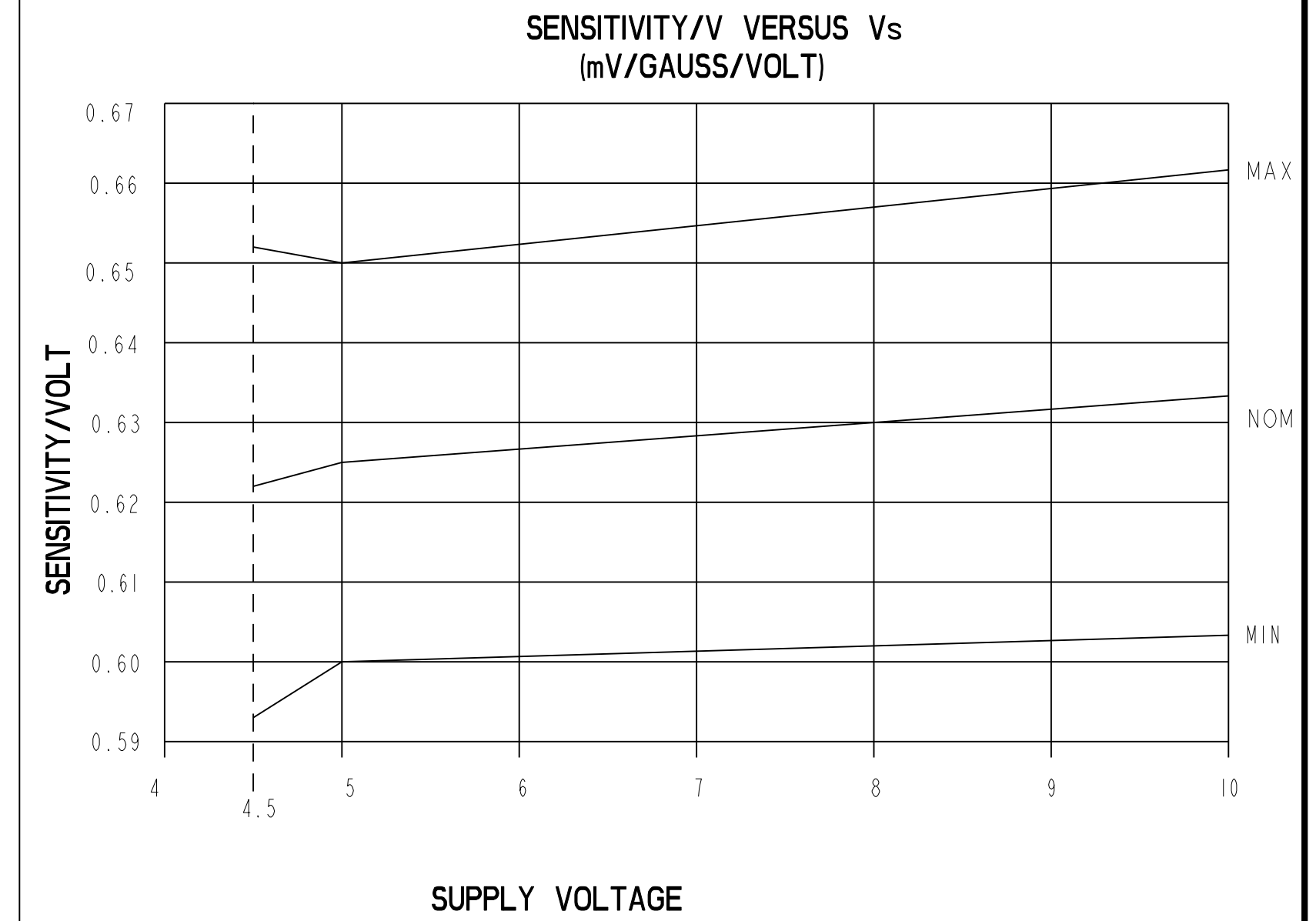
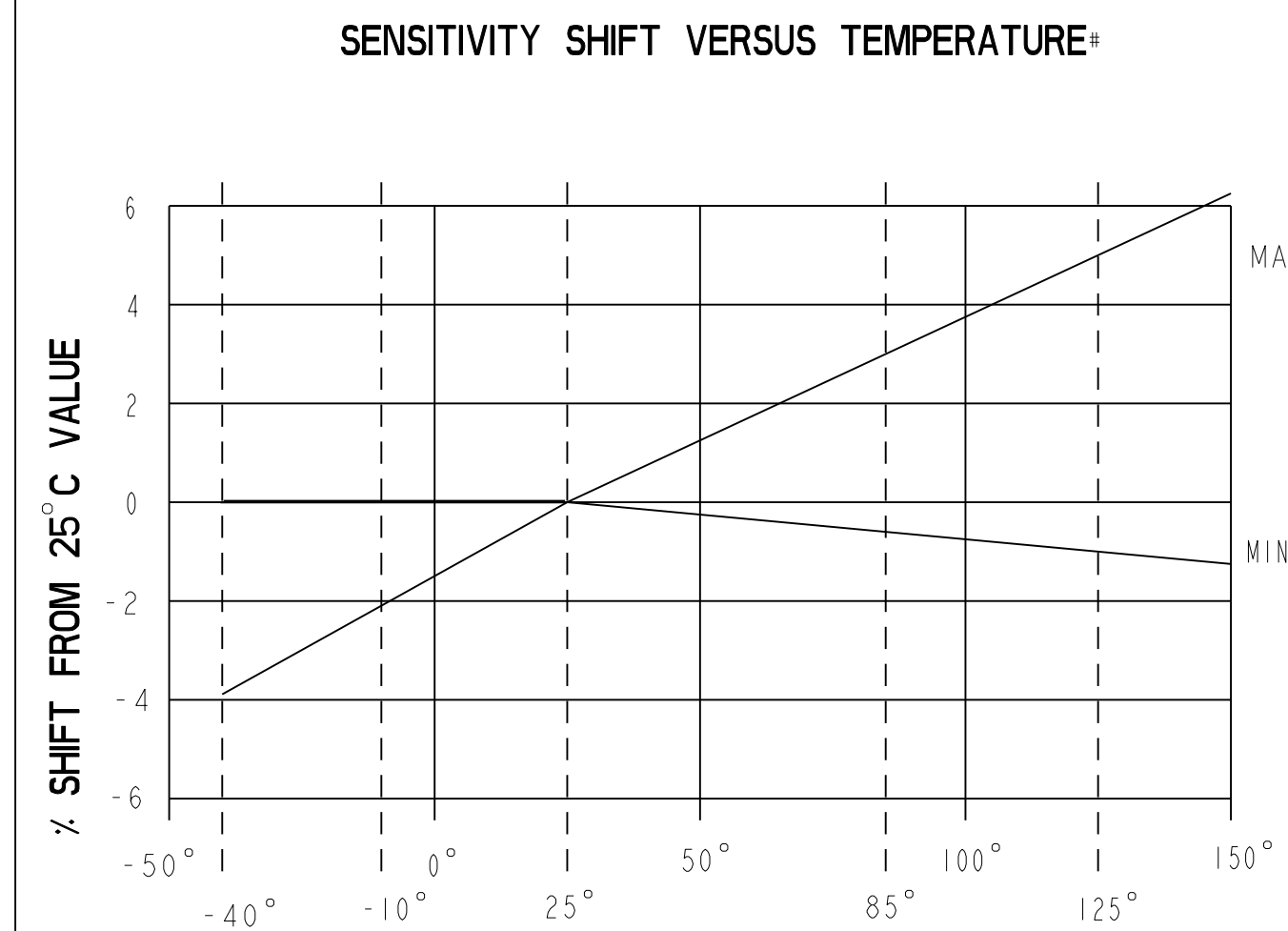
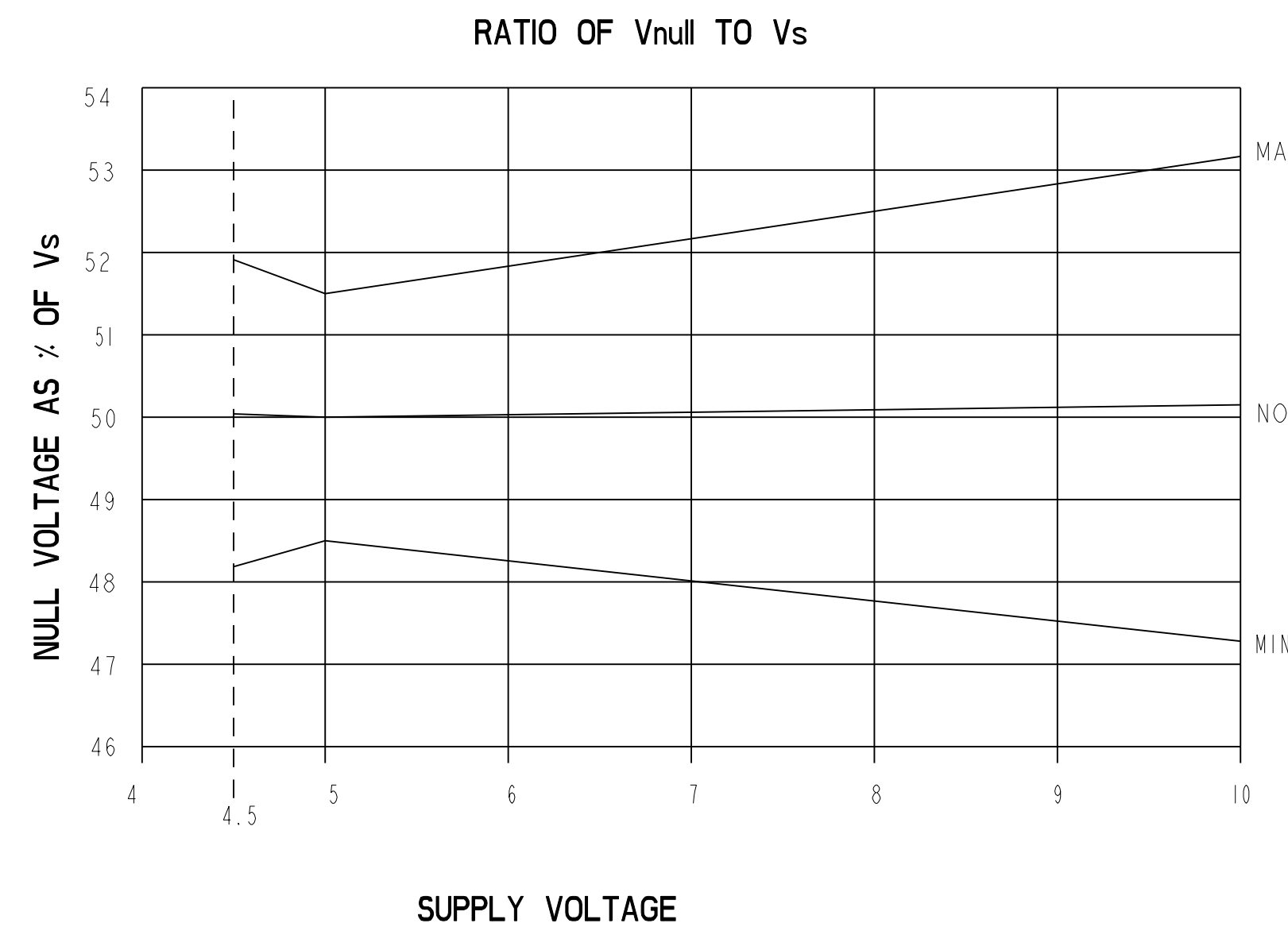
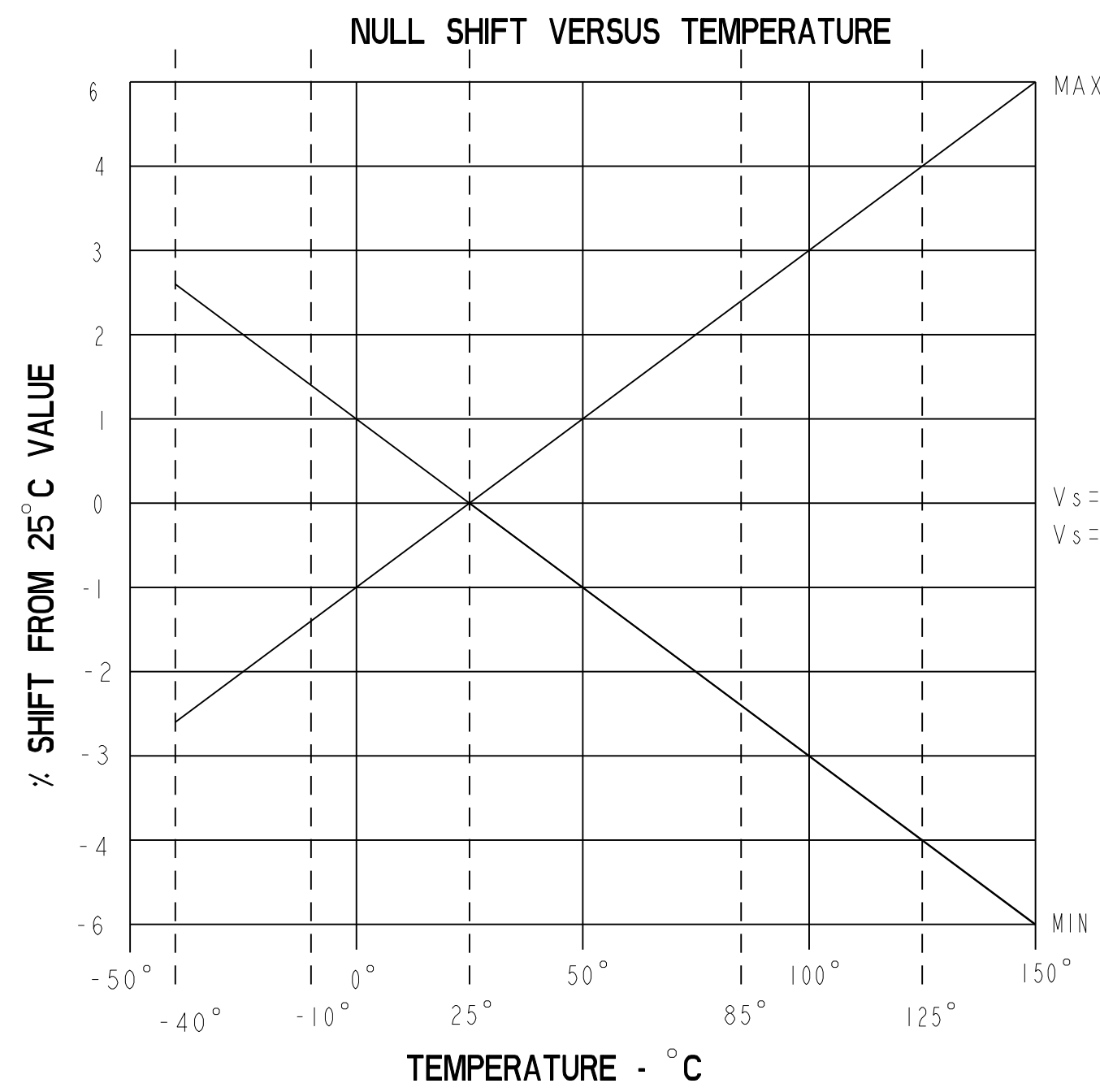

THIS DRAWING COVERS A PROPRIETARY ITEM AND IS THE PROPERTY OF MICRO SWITCH, A DIVISION OF HONEYWELL. THIS DRAWING IS NOT TO BE COPIED OR USED WITHOUT THE APPROVAL OF MICRO SWITCH.
 FED. MFG. CODE 91929
MICRO SWITCH
 a Honeywell Division
MINIATURE RATIO-METRIC LINEAR HALL EFFECT SENSOR
 SS495 SERIES CHART 1
 CATALOG LISTING

THIRD ANGLE PROJECTION	
SCALE	NONE
DO NOT SCALE PRINT	
UNLESS OTHERWISE SPECIFIED TOLERANCES ARE	
ONE PLACE	(.0) +.030
TWO PLACE	(.00) +.015
THREE PLACE	(.000) +.005
ANGLES	+2°
WEIGHT	

ANSI Y14.5M-1982 APPLIES

CHARACTERISTICS ARE AT $V_s=5.00$ WITH 4.7K OUTPUT TO MINUS WITH $T_A: -40^\circ\text{C}$ TO $+125^\circ\text{C}$ UNLESS OTHERWISE SPECIFIED

SS495A2

SS495 SERIES CHART 1

PARAMETER	CONDITIONS	MIN	TYP	MAX	UNITS
SENSITIVITY	$T_A = 25^\circ\text{C}$	2.969	3.125	3.281	mV/GAUSS
NULL	$T_A = 25^\circ\text{C}$	2.400	2.50	2.600	VOLTS
SUPPLY CURRENT	$T_A = 25^\circ\text{C}$		7	8.7	mA
OUTPUT CURRENT SOURCE	$V_s > 4.5$	1mA	1.5mA		
SINK	$V_s > 4.5$.6mA	1.5mA		
SINK	$V_s > 5.0$	1mA	1.5mA		
RESPONSE TIME			3 μs		
OUTPUT VOLTAGE SWING					
VOM -	-B APPLIED	.4	.2		VOLTS
VOM +	+B APPLIED	$V_s - .4$	$V_s - .2$		VOLTS
B LIMITS FOR LINEAR OPERATION					
-B MAX		-600	-670		GAUSS
+B MAX		+600	+670		GAUSS
V_{null} DRIFT	$B = 0, T_A = 25^\circ\text{C}$ TO 125°C	-.07		+.07	% / $^\circ\text{C}$
V_{null} DRIFT	$B = 0, T_A = +125^\circ\text{C}$ TO $+150^\circ\text{C}$	-.08		+.08	% / $^\circ\text{C}$
SENSITIVITY DRIFT	$T_A = +25^\circ\text{C}$ TO $+150^\circ\text{C}$	-.02		+.06	% / $^\circ\text{C}$
SENSITIVITY DRIFT	$T_A = -40^\circ\text{C}$ TO $+25^\circ\text{C}$	-.01		+.07	% / $^\circ\text{C}$
LINEARITY	$B = -600$ TO $+600$	0	-1.0	-1.5	% OF SPAN
SUPPLY VOLTAGE	-40°C TO $+125^\circ\text{C}$	4.5	5.0	10.5	VOLTS
OPERATING TEMP	SEE MAX TEMPERATURE CHART	-40		+150	$^\circ\text{C}$

BLOCK DIAGRAM CURRENT SINKING OR SOURCING OUTPUT

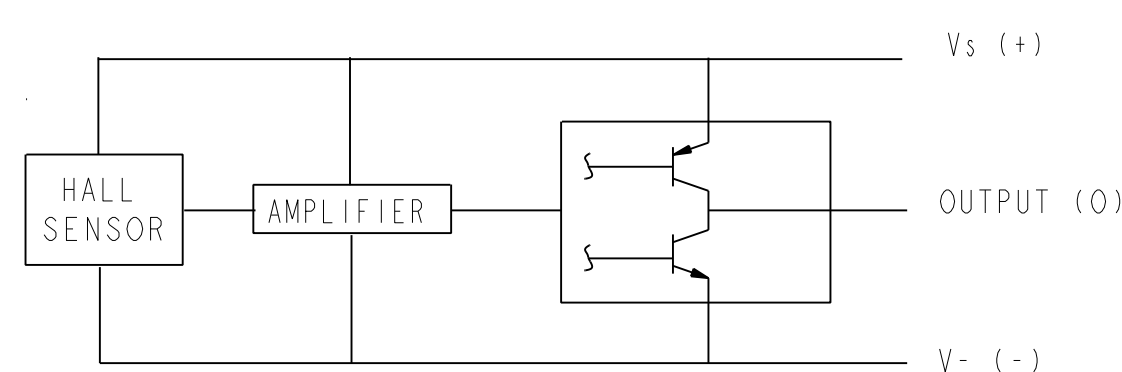

ABSOLUTE MAXIMUM CHARACTERISTICS

CHARACTERISTIC	SYMBOL	TEST CONDITION	MIN	MAX	UNITS
SUPPLY VOLTAGE	V_{cc}		-0.5	11	V
OUTPUT VOLTAGE	V_{out}		-0.5	11	V
OUTPUT CURRENT	I_{out}	SOURCE OR SINK	10		mA
TEMPERATURE	T_A	OPERATING	-55	150	$^\circ\text{C}$
	T_s	STORAGE ($V_{cc}=0$)	-55	165	$^\circ\text{C}$

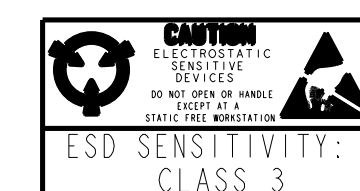
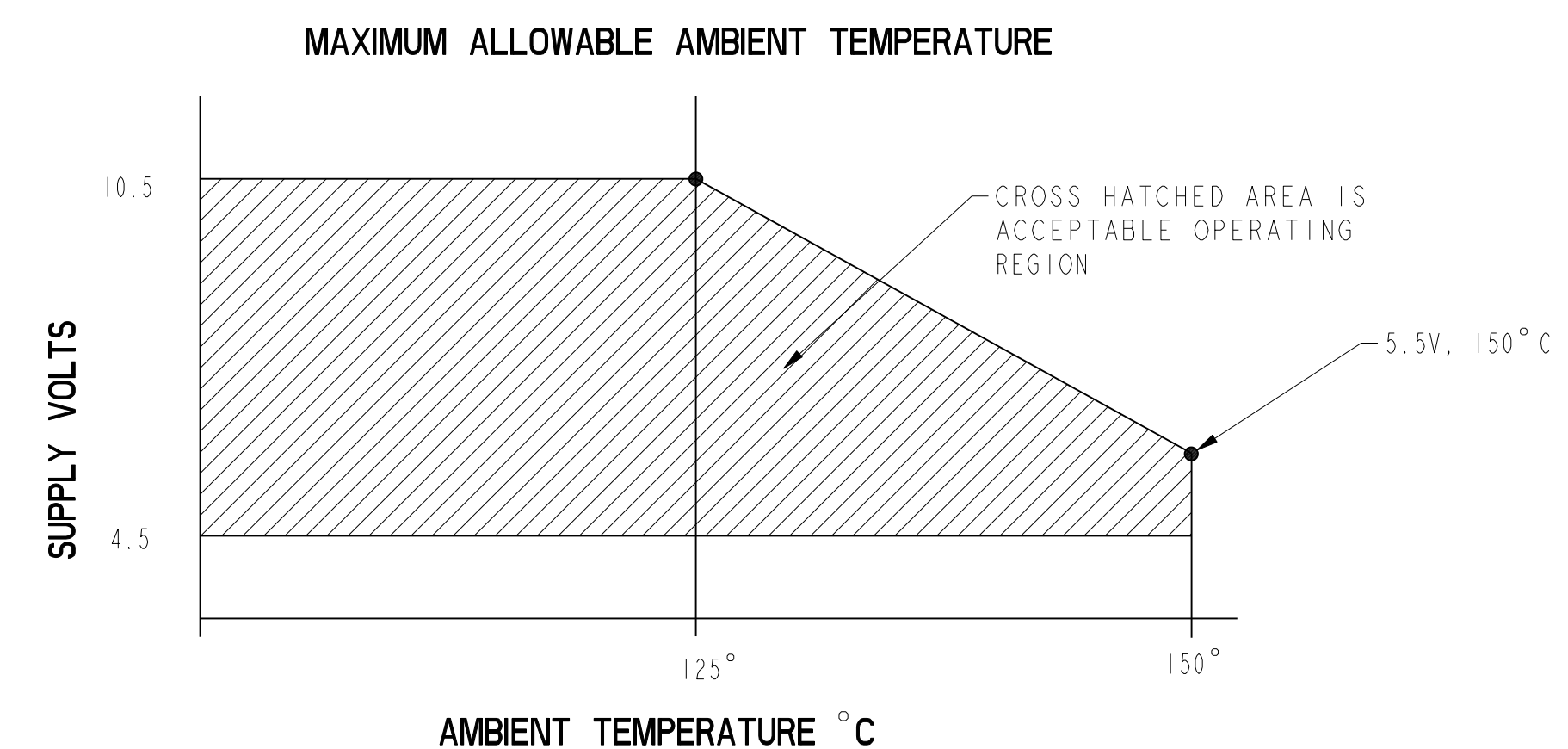
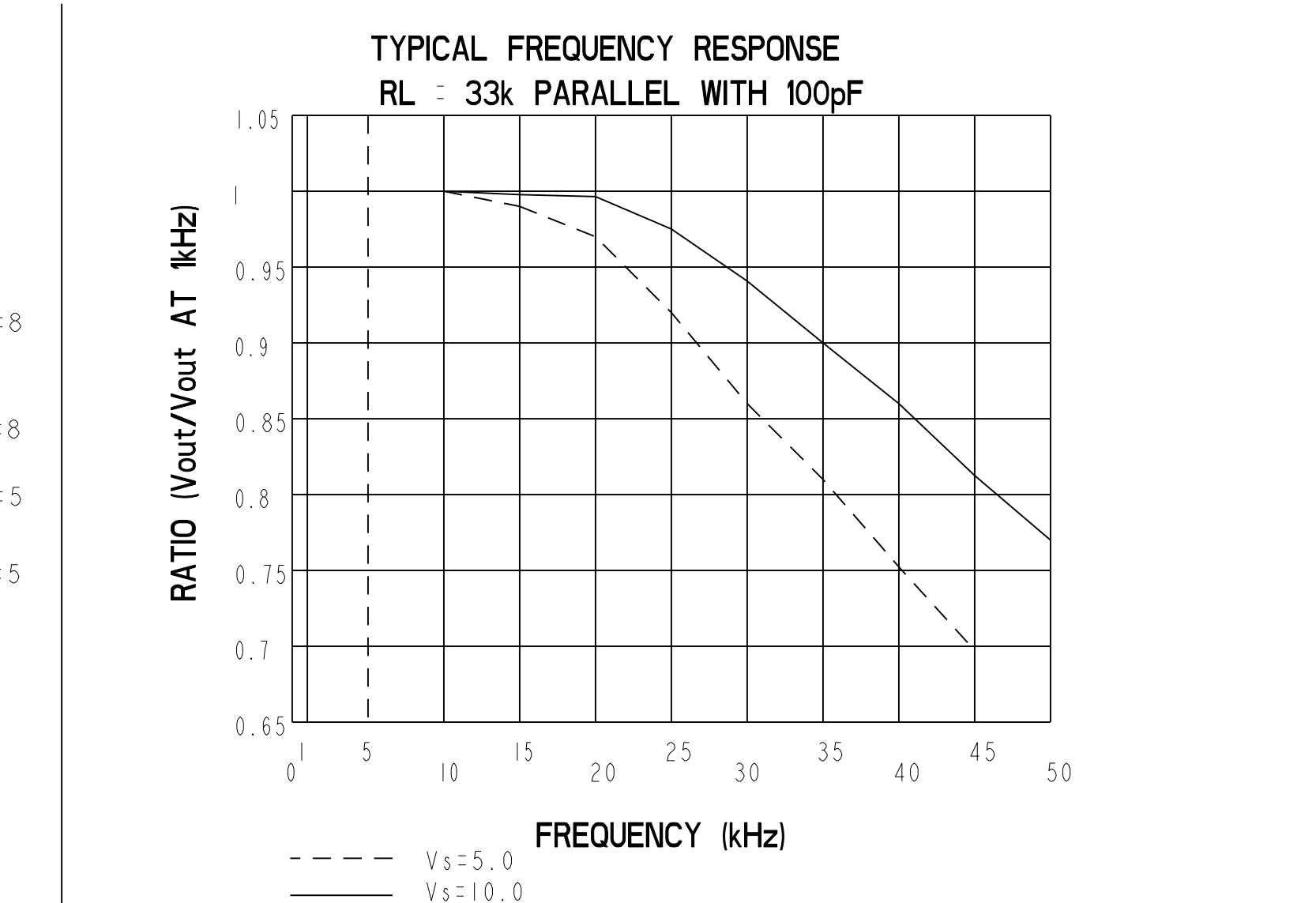
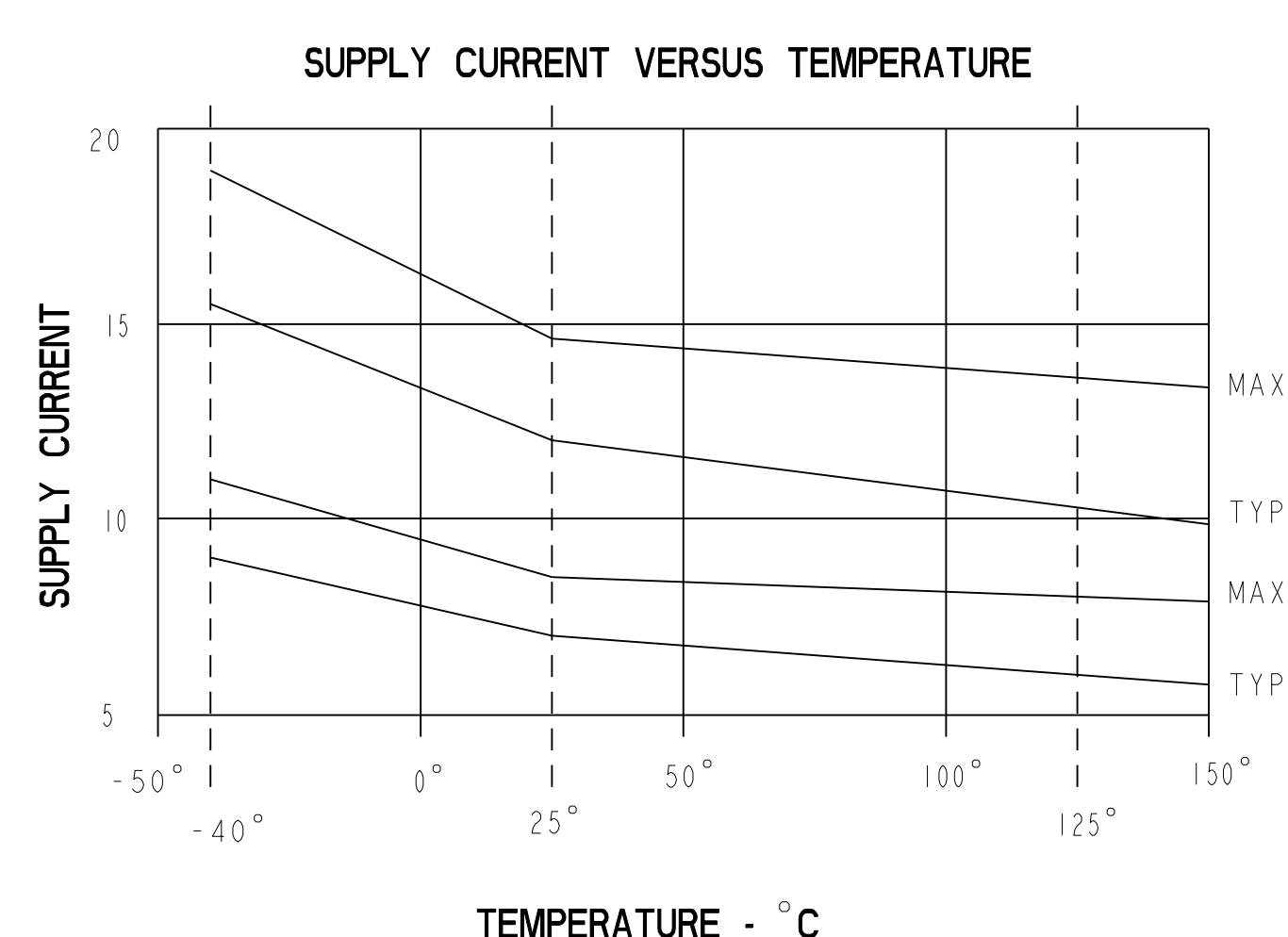
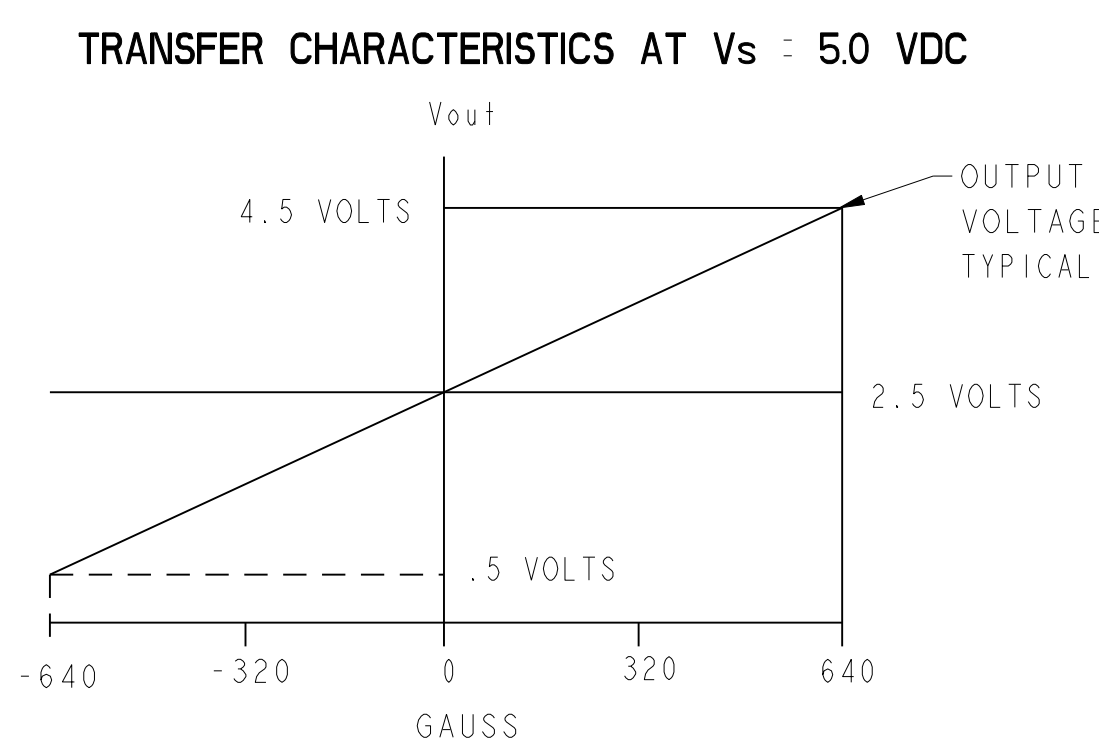
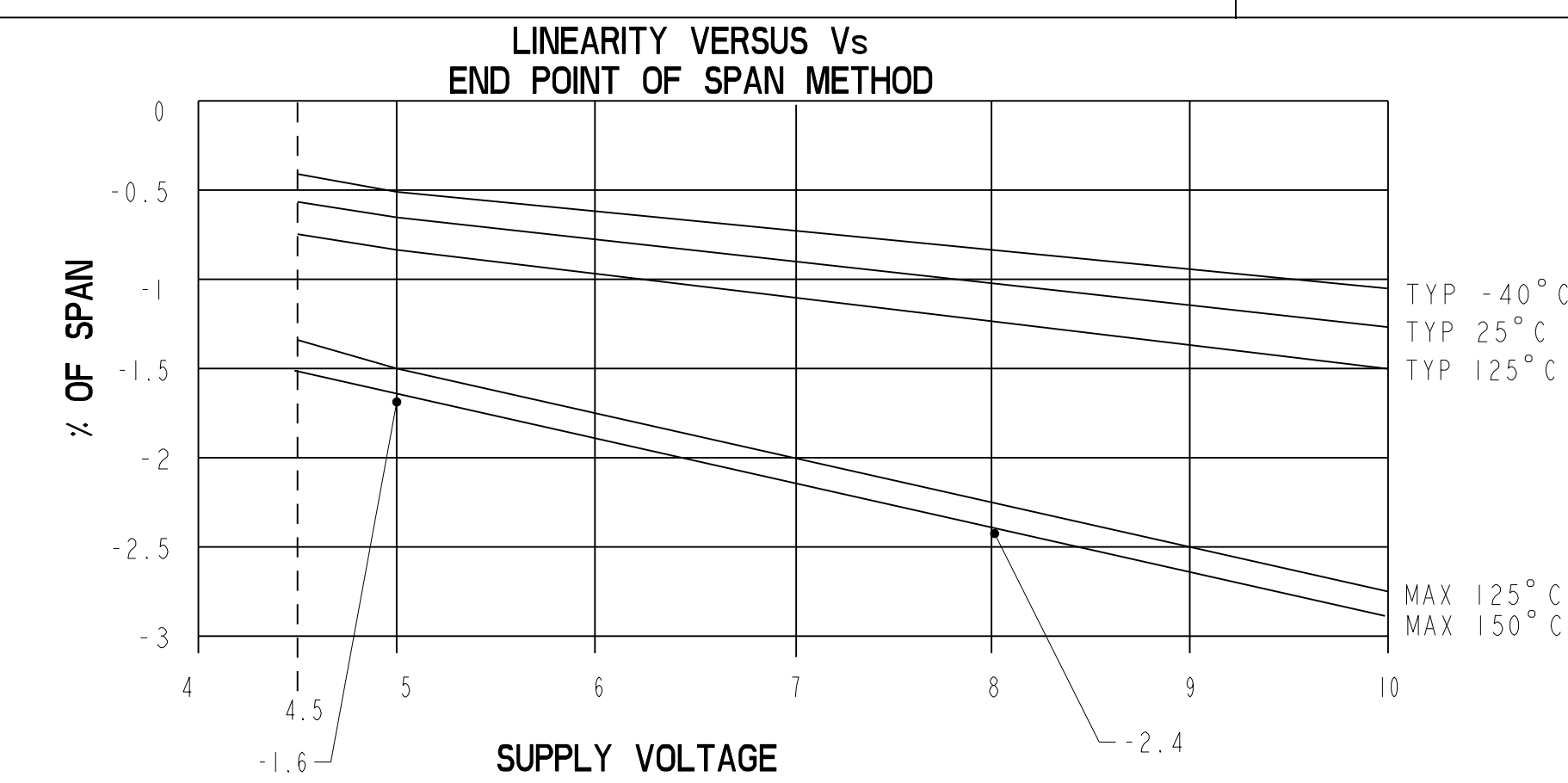
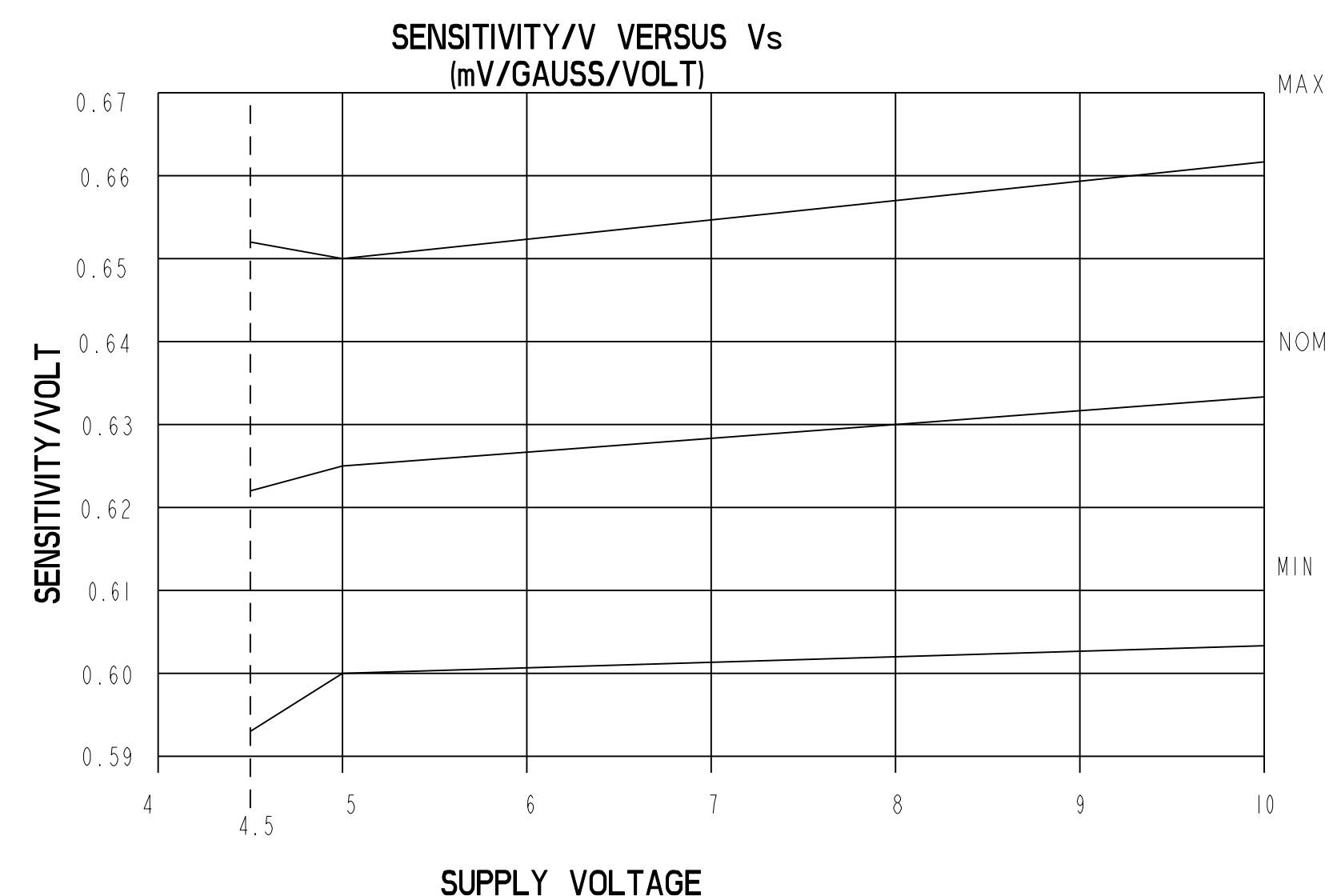
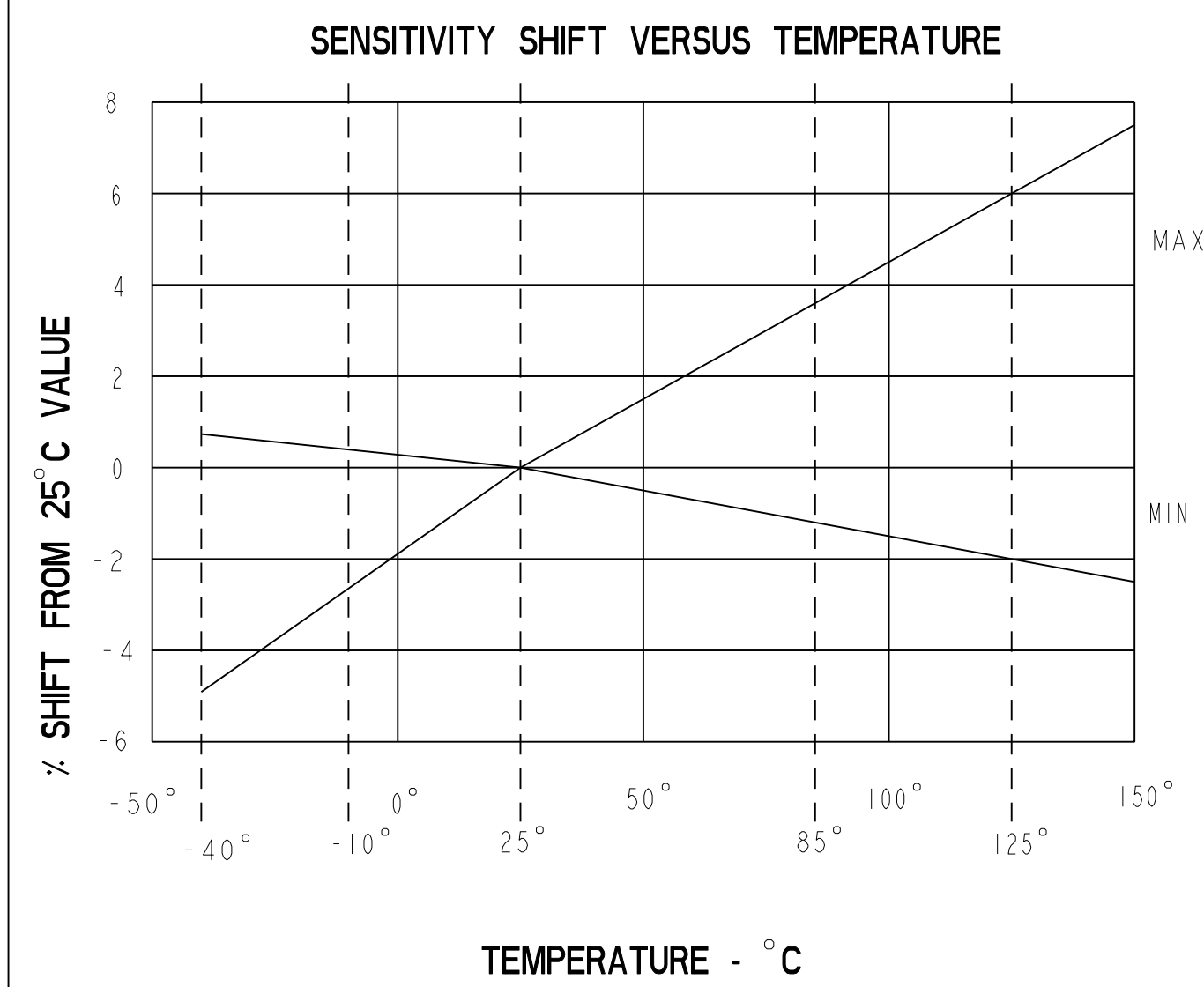
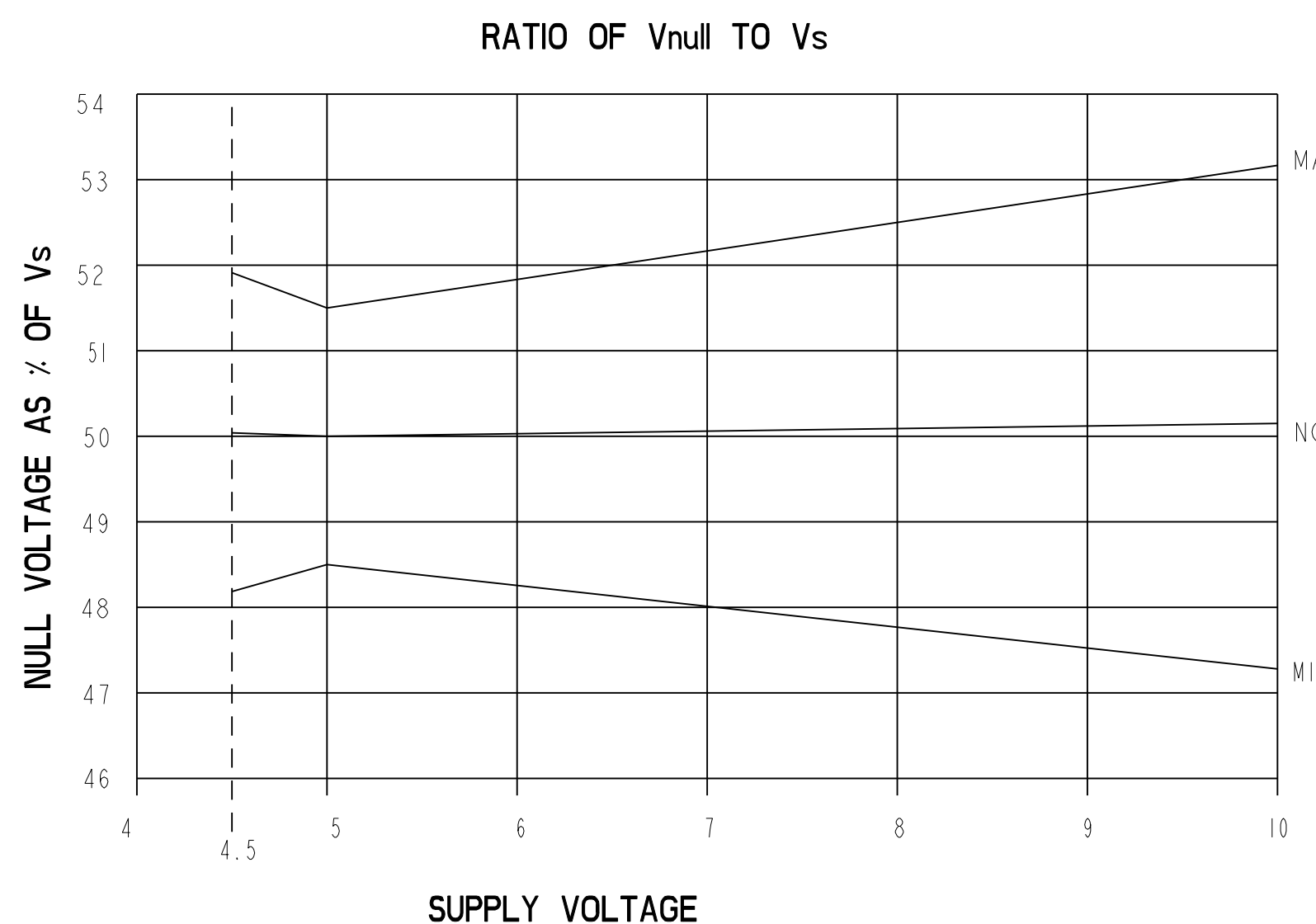
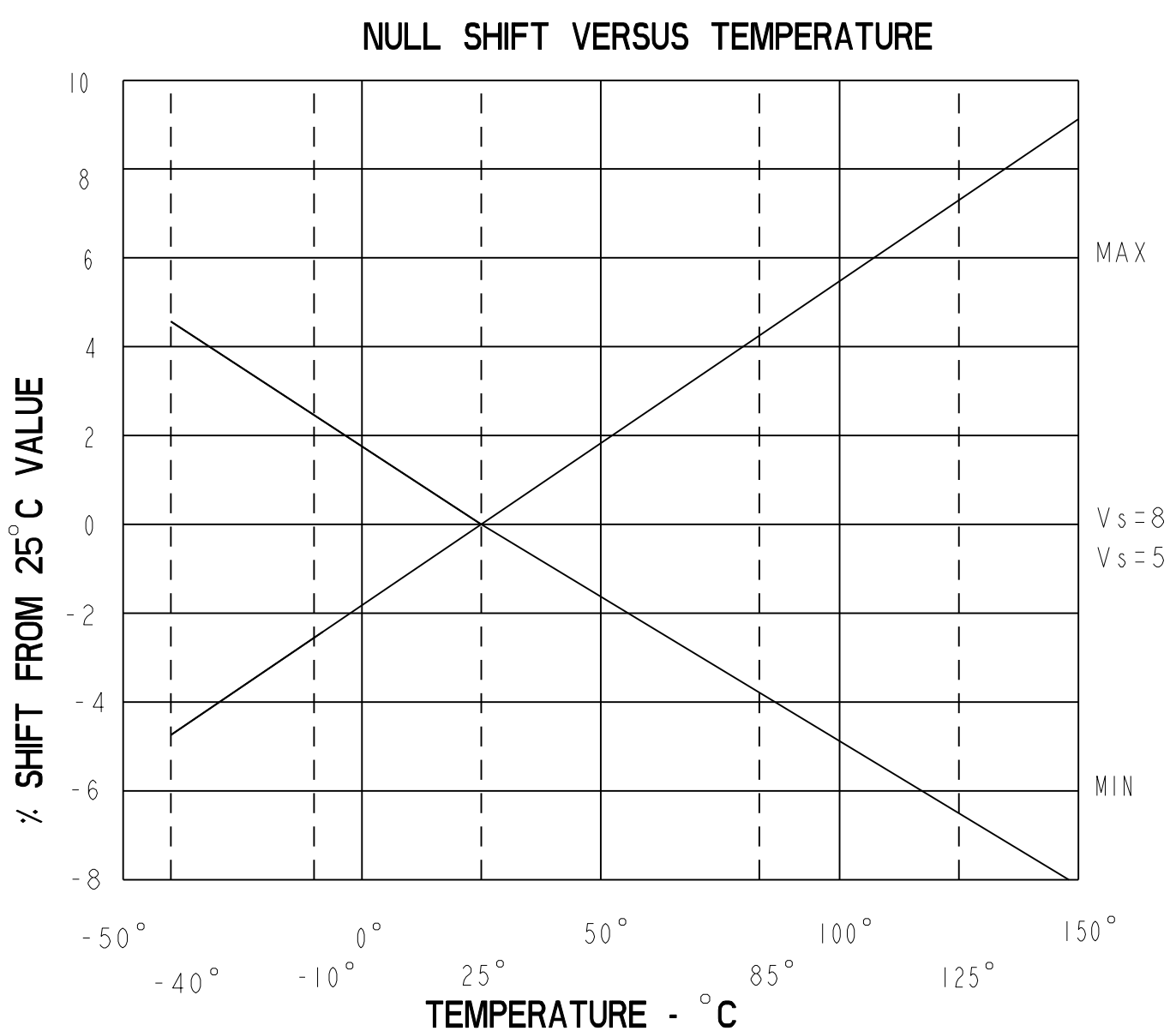

THIS DRAWING COVERS A PROPRIETARY ITEM AND IS THE PROPERTY OF MICRO SWITCH, A DIVISION OF HONEYWELL. THIS DRAWING IS NOT TO BE COPIED OR USED WITHOUT THE APPROVAL OF MICRO SWITCH.

FED. MFG. CODE 91929
MICRO SWITCH
 a Honeywell Division

CATALOG LISTING
MINIATURE RATIOMETRIC
LINEAR HALL EFFECT SENSOR
SS495 SERIES CHART 1

THIRD ANGLE PROJECTION	
SCALE	NONE
DO NOT SCALE PRINT	
UNLESS OTHERWISE SPECIFIED TOLERANCES ARE	
ONE PLACE	(.0) +.030
TWO PLACE	(.00) +.015
THREE PLACE	(.000) +.005
ANGLES	+2°
WEIGHT	

ANSI Y14.5M-1982 APPLIES

PTC/CAD 2D
 DRAWN: C.S.L. 15 APR 02
 CHECK: SAV 5 APR 02
 APPROVED: [Signature]
 RELEASE NO. PR-22532
 SS495 SERIES CHART 1
 DRAWING NUMBER: 4 OF 5
 ISSUE: 14
 DATE: 26 OCT 01
 REV: 15
 C: 003635
 26 OCT 01

CHARACTERISTICS ARE AT $V_s=5.00$ WITH 4.7K OUTPUT TO MINUS WITH $T_A: -40^\circ\text{C}$ TO $+125^\circ\text{C}$ UNLESS OTHERWISE SPECIFIED

SS495B

SS495 SERIES CHART 1

PARAMETER	CONDITIONS	MIN	TYP	MAX	UNITS
SENSITIVITY	$T_A = 25^\circ\text{C}$	2.875	3.125	3.375	mV/GAUSS
NULL	$T_A = 25^\circ\text{C}$	2.35	2.50	2.650	VOLTS
SUPPLY CURRENT	$T_A = 25^\circ\text{C}$		7	8.7	mA
OUTPUT CURRENT SOURCE	$V_s > 4.5$	1mA	1.5mA		
SINK	$V_s > 4.5$.6mA	1.5mA	
SINK	$V_s > 5.0$	1mA	1.5mA		
RESPONSE TIME			3μS		
OUTPUT VOLTAGE SWING					
VOM -	-B APPLIED	.4	.2		VOLTS
VOM +	+B APPLIED	$V_s - .4$	$V_s - .2$		VOLTS
B LIMITS FOR LINEAR OPERATION					GAUSS
	-B MAX	-600	-670		
	+B MAX	+600	+670		
V_{null} DRIFT	$B = 0, T_A = 25^\circ\text{C}$ TO 125°C	-.08		+.08	% / °C
V_{null} DRIFT	$B = 0, T_A = +125^\circ\text{C}$ TO $+150^\circ\text{C}$	-.08		+.08	% / °C
SENSITIVITY DRIFT	$T_A = +25^\circ\text{C}$ TO $+150^\circ\text{C}$	-.02		+.08	% / °C
SENSITIVITY DRIFT	$T_A = -40^\circ\text{C}$ TO $+25^\circ\text{C}$	-.02		+.08	% / °C
LINEARITY	$B = -600$ TO $+600$	0	-1.0	-1.5	% OF SPAN
SUPPLY VOLTAGE	-40°C TO $+125^\circ\text{C}$	4.5	5.0	10.5	VOLTS
OPERATING TEMP	SEE MAX TEMPERATURE CHART	-40		+150	°C

BLOCK DIAGRAM CURRENT SINKING OR SOURCING OUTPUT

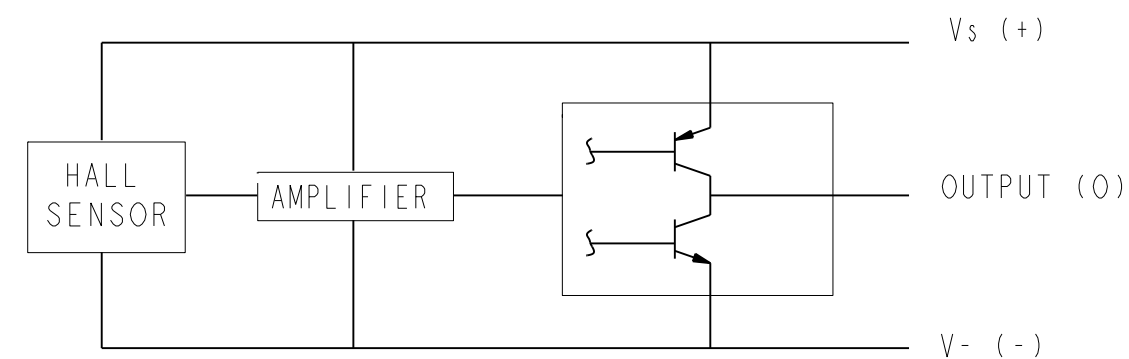

ABSOLUTE MAXIMUM CHARACTERISTICS

CHARACTERISTIC	SYMBOL	TEST CONDITION	MIN	MAX	UNITS
SUPPLY VOLTAGE	V_{cc}		-0.5	11	V
OUTPUT VOLTAGE	V_{out}		-0.5	11	V
OUTPUT CURRENT	I_{out}	SOURCE OR SINK	10		mA
TEMPERATURE	T_A	OPERATING	-55	150	°C
	T_s	STORAGE ($V_{cc}=0$)	-55	165	°C

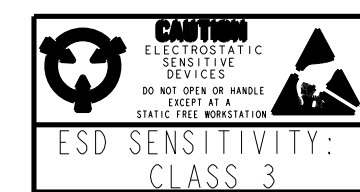
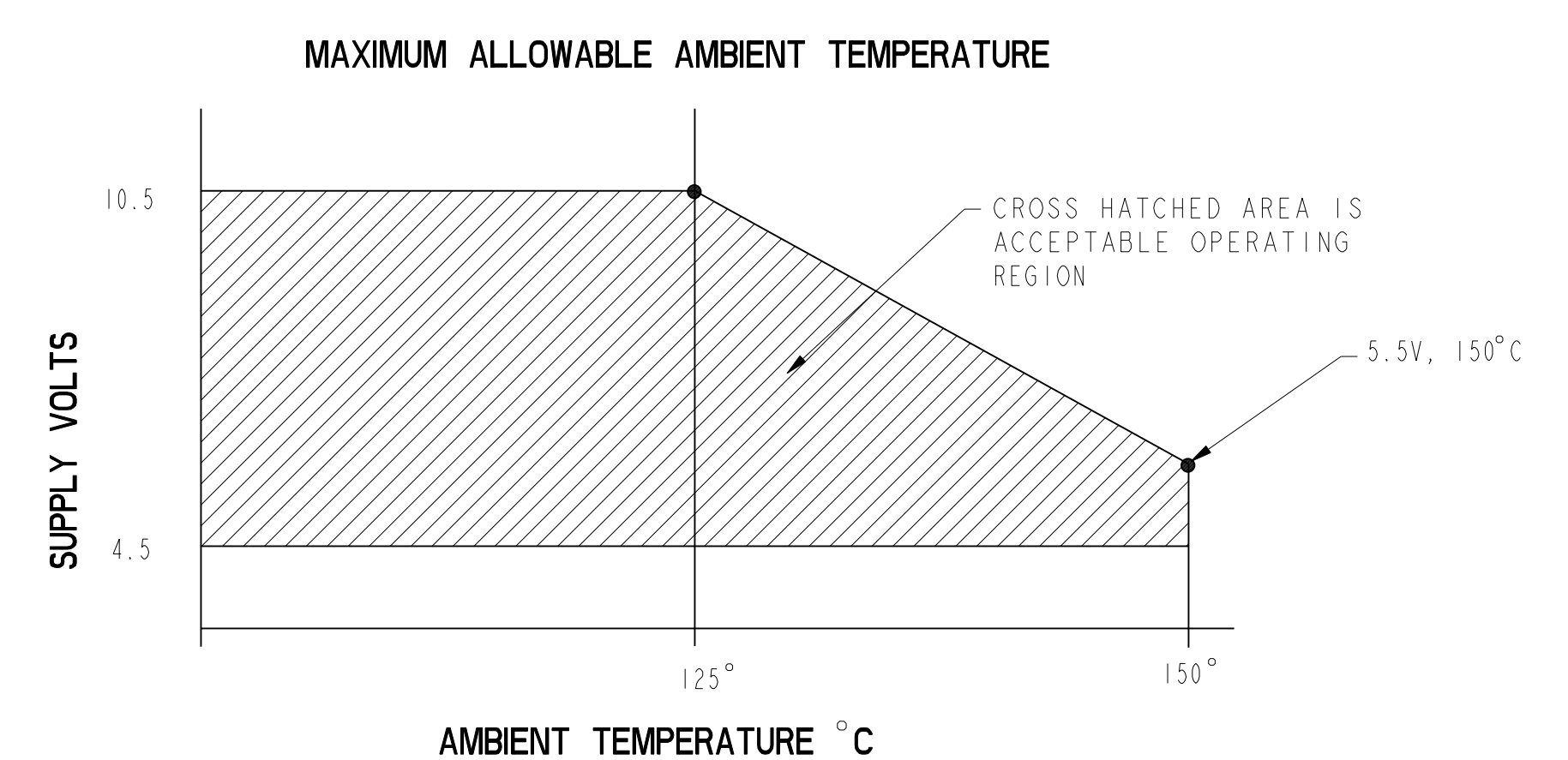
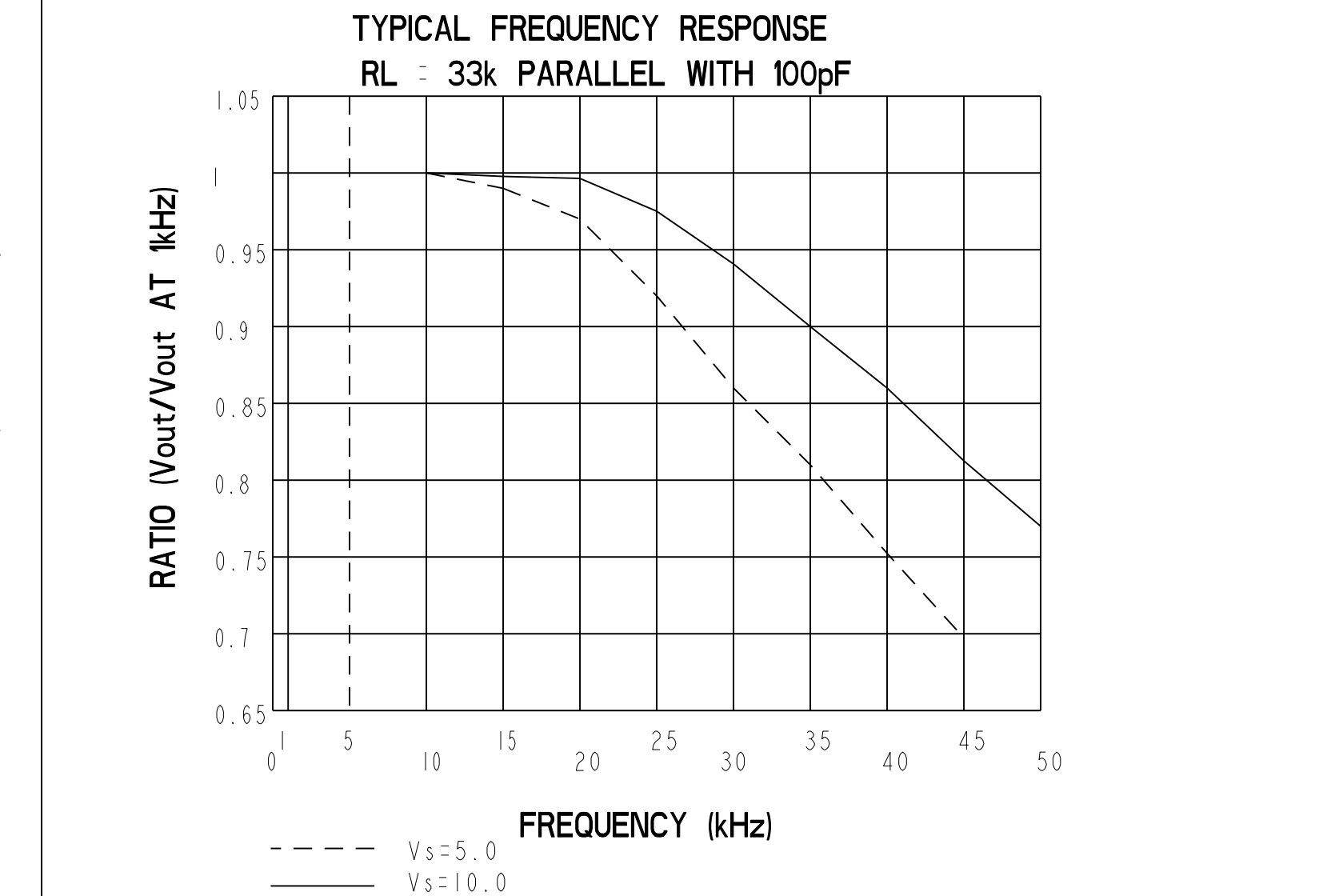
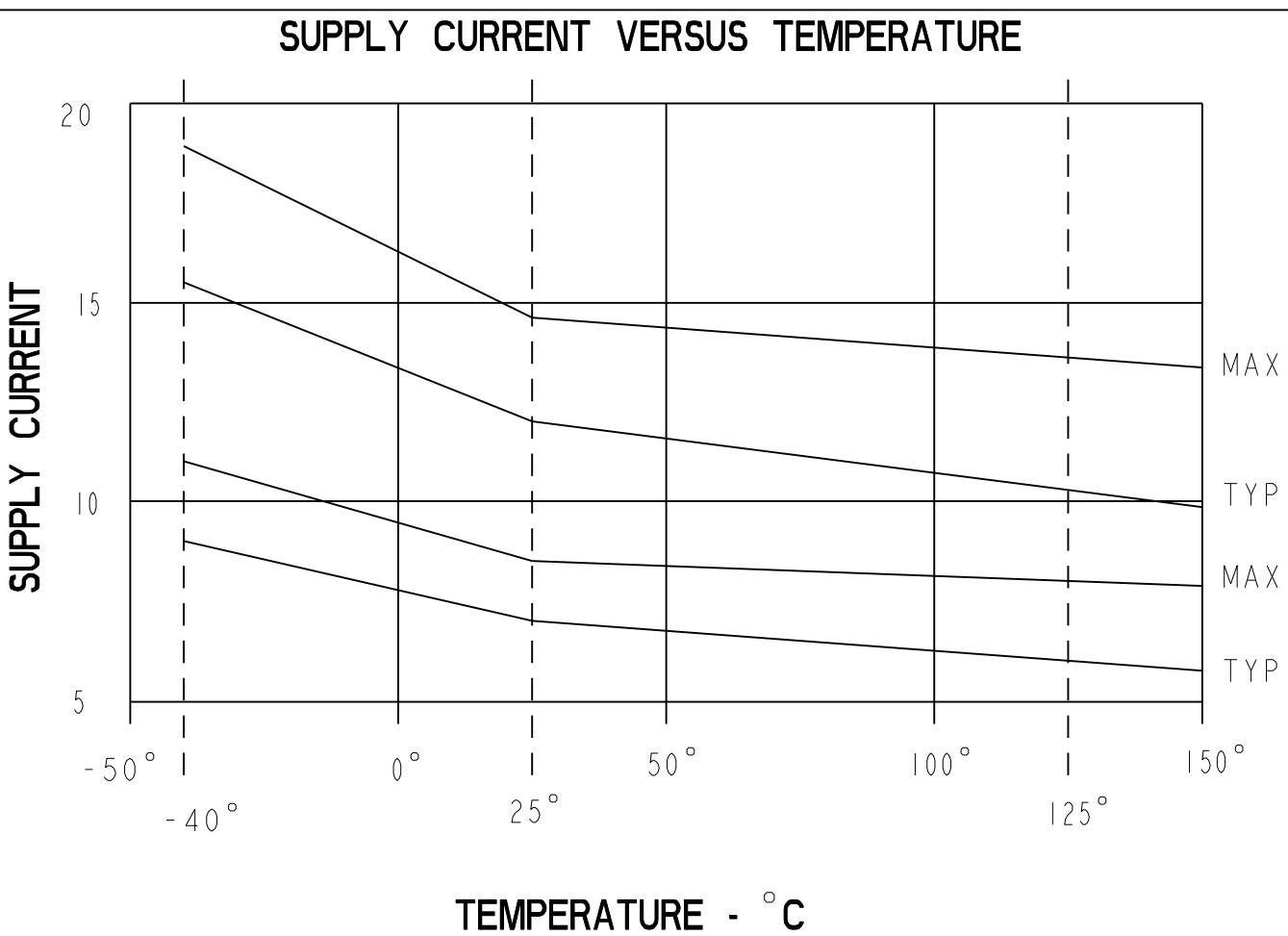
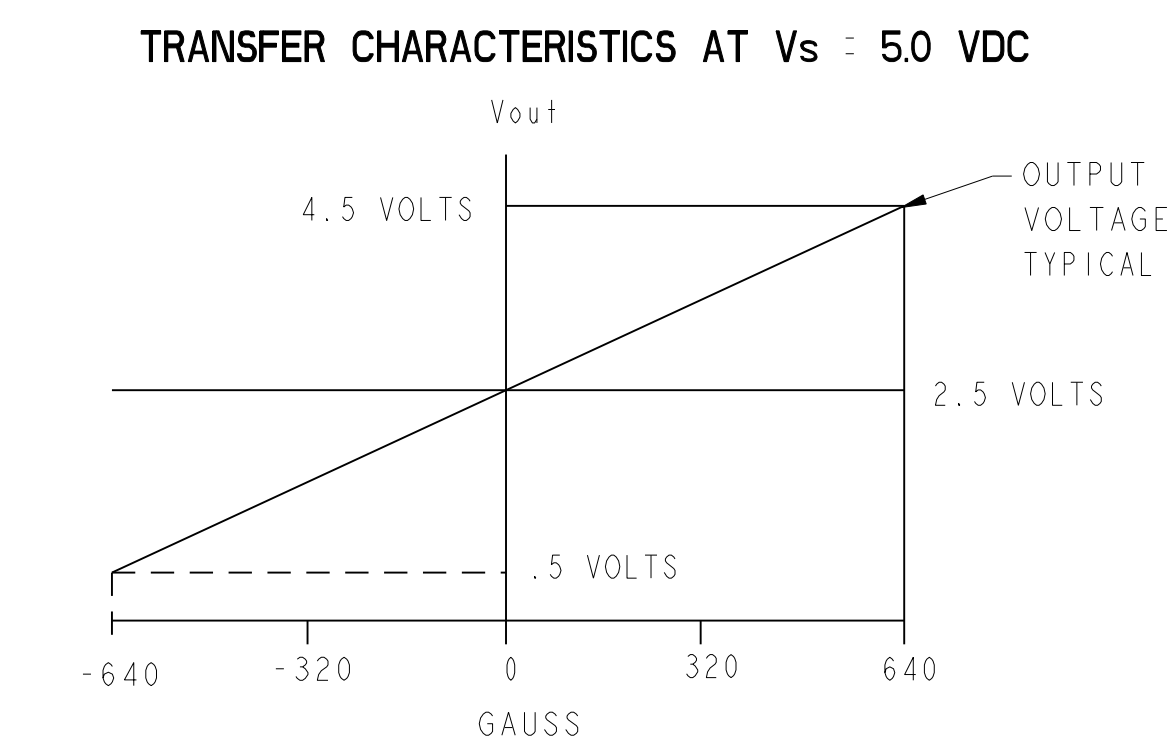
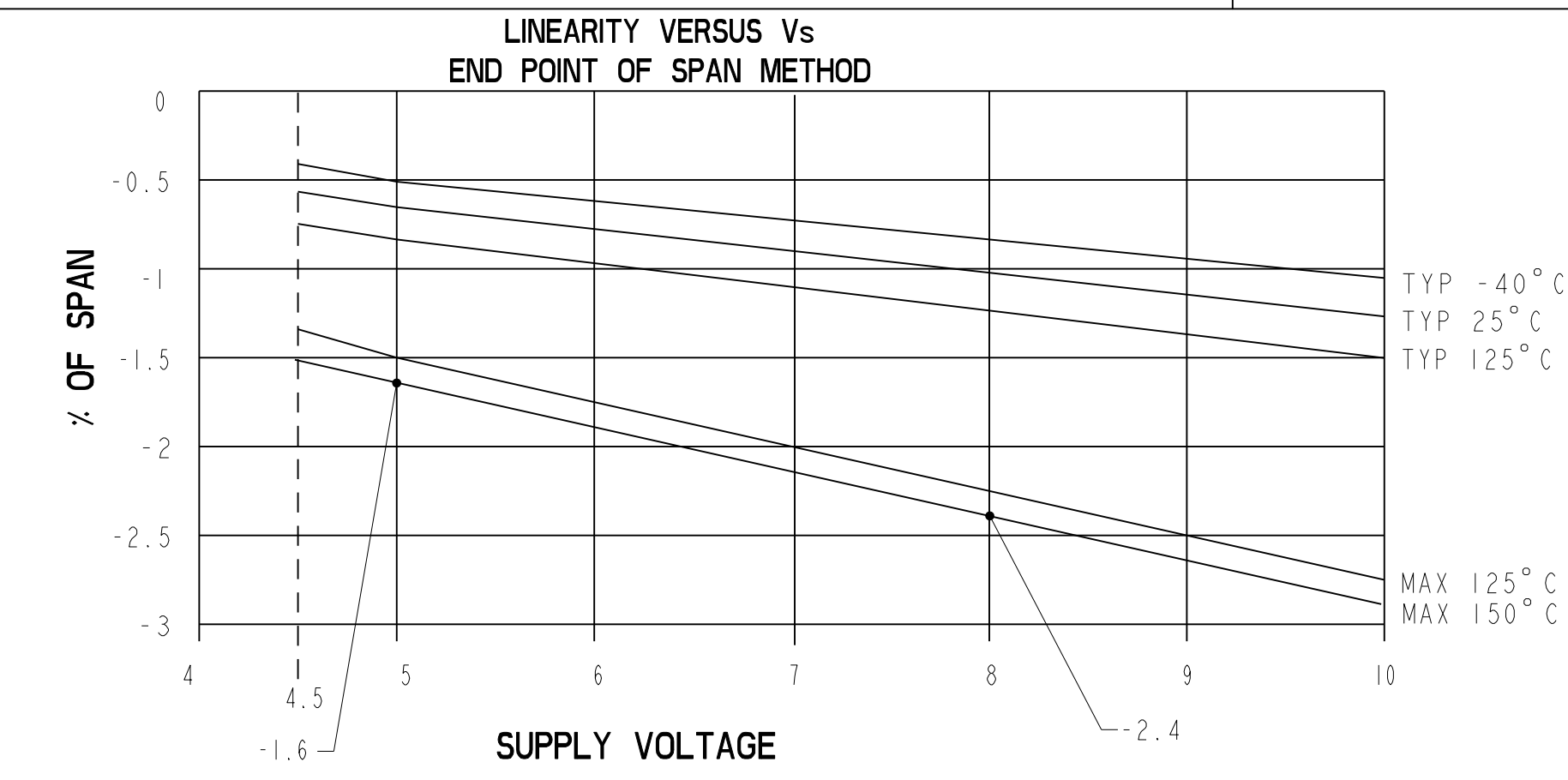
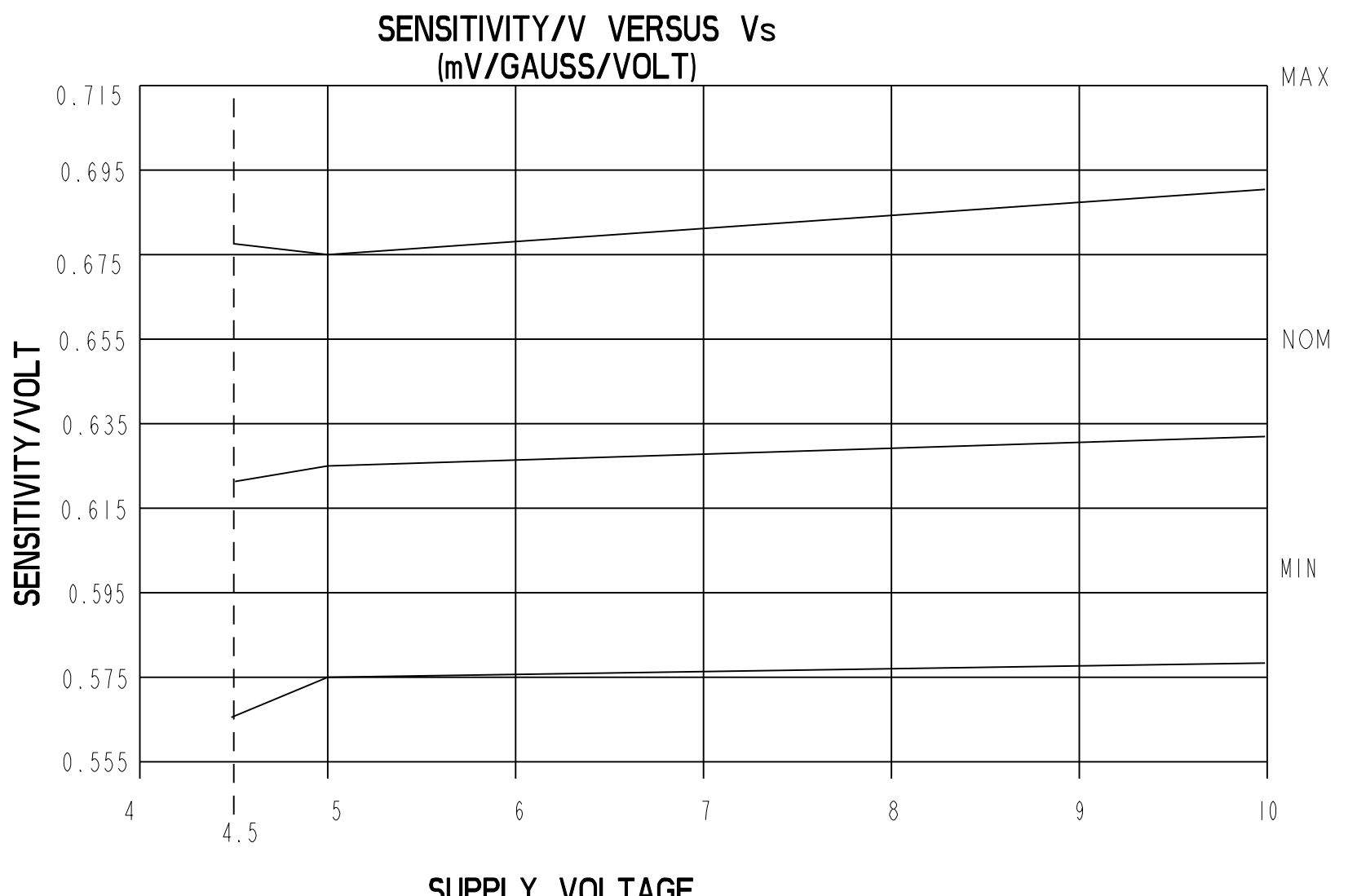
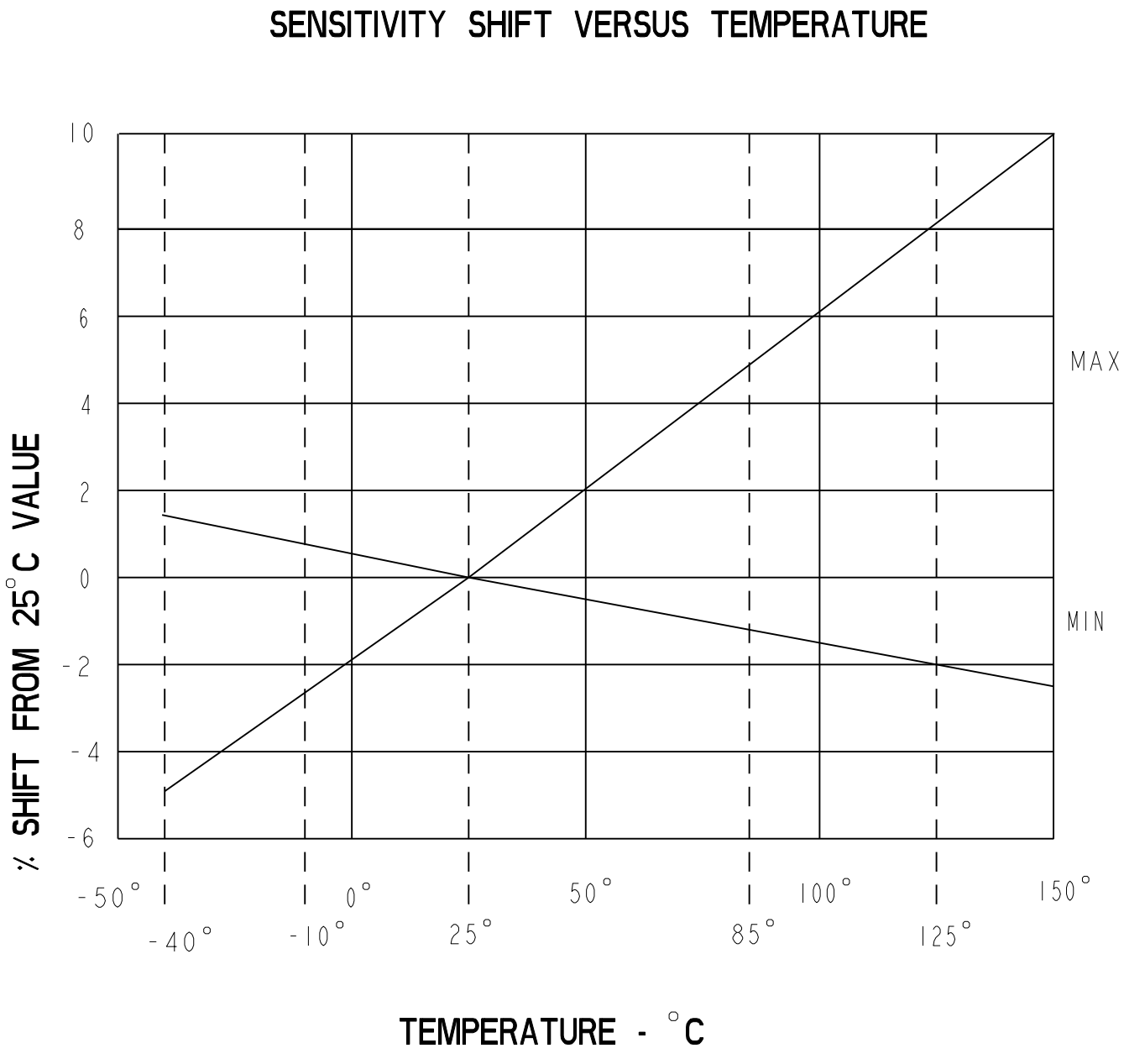
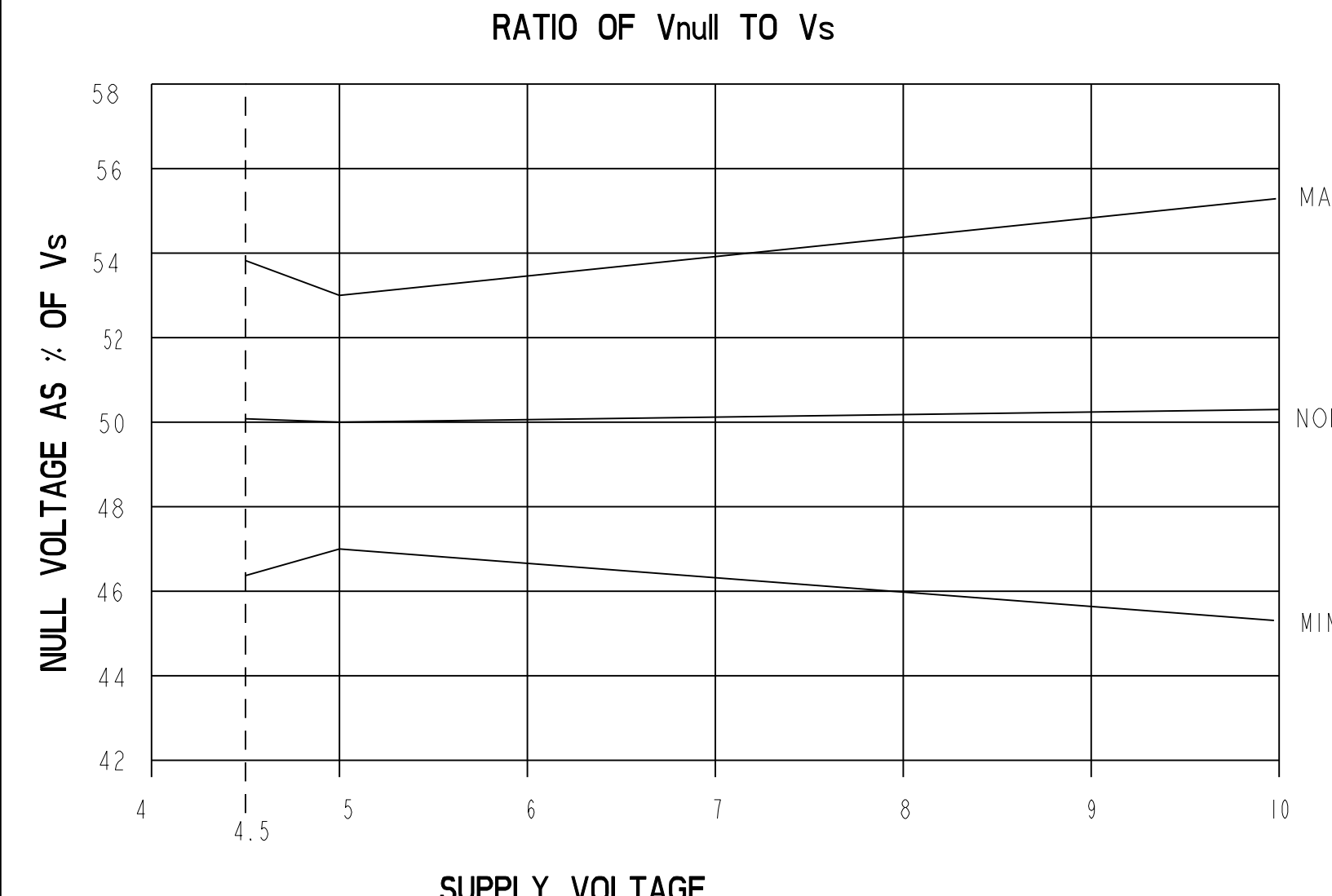
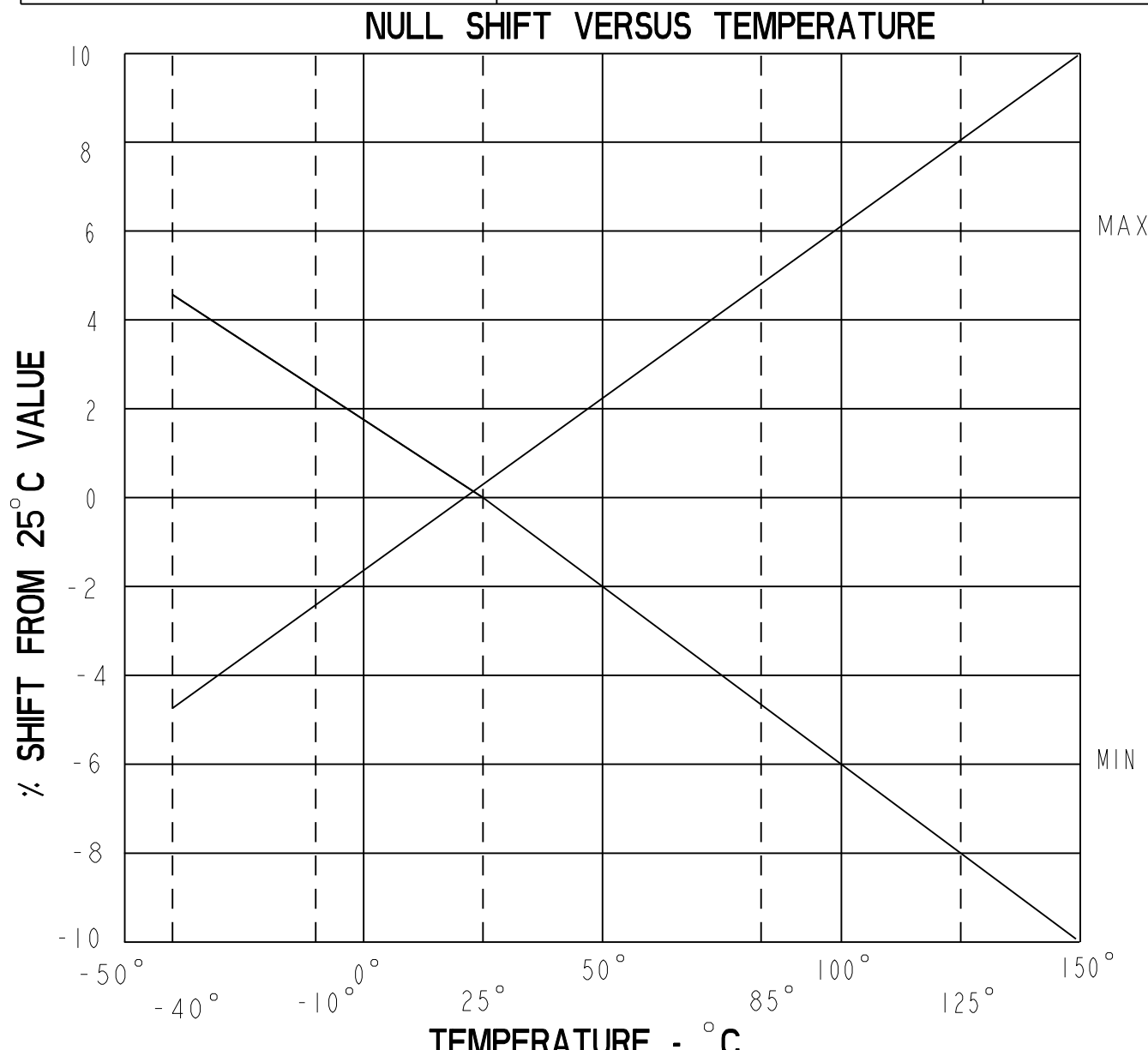

THIS DRAWING COVERS A PROPRIETARY ITEM AND IS THE PROPERTY OF MICRO SWITCH, A DIVISION OF HONEYWELL. THIS DRAWING IS NOT TO BE COPIED OR USED WITHOUT THE APPROVAL OF MICRO SWITCH.

FED. MFG. CODE 91929

MICRO SWITCH
a Honeywell Division

**MINIATURE RATIOMETRIC
LINEAR HALL EFFECT SENSOR**

SS495 SERIES CHART 1

THIRD ANGLE PROJECTION

SCALE NONE

DO NOT SCALE PRINT

UNLESS OTHERWISE SPECIFIED TOLERANCES ARE

ONE PLACE (.0) +.030

TWO PLACE (.00) +.015

THREE PLACE (.000) +.005

ANGLES +2°

WEIGHT

PTC/CAD 20
 DRAWN
 C.S. L. 15 APR 02
 CHECK
 S.A.V. 5 APR 02
 APPROVED
 14
 ISSUE
 DRAWING NUMBER
 5 OF 5
 RELEASE NO. PR-24083
 REVISIONS
 C 0036335
 26 OCT 01
 MICRO SWITCH
 1415 W. 14TH AVENUE
 DENVER, CO 80202
 PHONE 303.751.7000
 FAX 303.751.7001
 WWW.MICROSWITCH.COM

Данный компонент на территории Российской Федерации

Вы можете приобрести в компании MosChip.

Для оперативного оформления запроса Вам необходимо перейти по данной ссылке:

<http://moschip.ru/get-element>

Вы можете разместить у нас заказ для любого Вашего проекта, будь то серийное производство или разработка единичного прибора.

В нашем ассортименте представлены ведущие мировые производители активных и пассивных электронных компонентов.

Нашей специализацией является поставка электронной компонентной базы двойного назначения, продукции таких производителей как XILINX, Intel (ex.ALTERA), Vicor, Microchip, Texas Instruments, Analog Devices, Mini-Circuits, Amphenol, Glenair.

Сотрудничество с глобальными дистрибьюторами электронных компонентов, предоставляет возможность заказывать и получать с международных складов практически любой перечень компонентов в оптимальные для Вас сроки.

На всех этапах разработки и производства наши партнеры могут получить квалифицированную поддержку опытных инженеров.

Система менеджмента качества компании отвечает требованиям в соответствии с ГОСТ Р ИСО 9001, ГОСТ РВ 0015-002 и ЭС РД 009

Офис по работе с юридическими лицами:

105318, г.Москва, ул.Щербаковская д.3, офис 1107, 1118, ДЦ «Щербаковский»

Телефон: +7 495 668-12-70 (многоканальный)

Факс: +7 495 668-12-70 (доб.304)

E-mail: info@moschip.ru

Skype отдела продаж:

moschip.ru

moschip.ru_4

moschip.ru_6

moschip.ru_9