





CHARACTERISTICS ARE AT  $V_s=5.00$  WITH 4.7K OUTPUT TO MINUS WITH  $T_A = -40^\circ\text{C}$  TO  $+125^\circ\text{C}$  UNLESS OTHERWISE SPECIFIED

SS495A1

SS495 SERIES CHART 1

PARAMETER	CONDITIONS	MIN	TYP	MAX	UNITS
SENSITIVITY	$T_A = 25^\circ\text{C}$	3.031	3.125	3.219	mV/GAUSS
NULL	$T_A = 25^\circ\text{C}$	2.425	2.50	2.575	VOLTS
SUPPLY CURRENT	$T_A = 25^\circ\text{C}$		7	8.7	mA
OUTPUT CURRENT SOURCE	$V_s > 4.5$	1mA	1.5mA		
	SINK	$V_s > 4.5$	.6mA	1.5mA	
	SINK	$V_s > 5.0$	1mA	1.5mA	
RESPONSE TIME			3 $\mu\text{s}$		
OUTPUT VOLTAGE SWING	VOM -		.4	.2	VOLTS
	VOM +	+B APPLIED	$V_s - .4$	$V_s - .2$	VOLTS
B LIMITS FOR LINEAR OPERATION	-B MAX	-600	-670		GAUSS
	+B MAX	+600	+670		GAUSS
$V_{null}$ DRIFT	$B = 0, T_A = 25^\circ\text{C}$ TO $125^\circ\text{C}$	-.04		+.04	% / $^\circ\text{C}$
$V_{null}$ DRIFT	$B = 0, T_A = +125^\circ\text{C}$ TO $+150^\circ\text{C}$	-.08		+.08	% / $^\circ\text{C}$
SENSITIVITY DRIFT	$T_A = +25^\circ\text{C}$ TO $+150^\circ\text{C}$	-.01		+.05	% / $^\circ\text{C}$
SENSITIVITY DRIFT	$T_A = -40^\circ\text{C}$ TO $+25^\circ\text{C}$	0		+.06	% / $^\circ\text{C}$
LINEARITY	$B = -600$ TO $+600$	0	-1.0	-1.5	% OF SPAN
SUPPLY VOLTAGE	$-40^\circ\text{C}$ TO $+125^\circ\text{C}$	4.5	5.0	10.5	VOLTS
OPERATING TEMP	SEE MAX TEMPERATURE CHART	-40		+150	$^\circ\text{C}$

BLOCK DIAGRAM CURRENT SINKING OR SOURCING OUTPUT

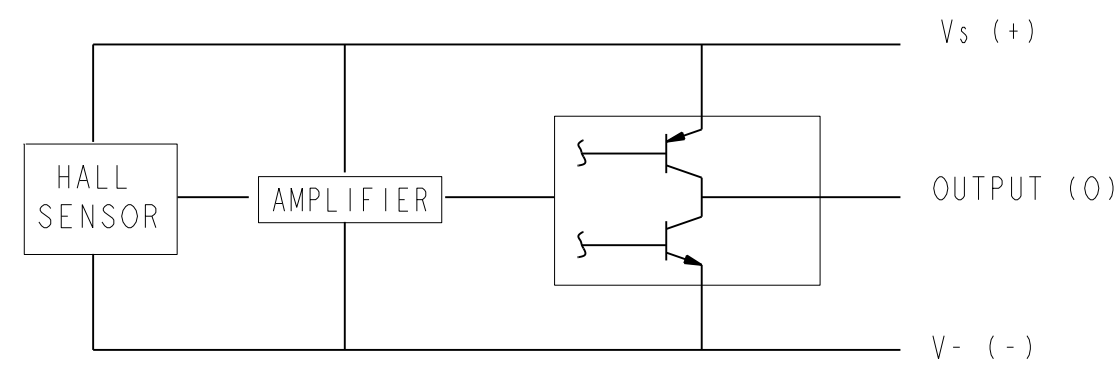

ABSOLUTE MAXIMUM CHARACTERISTICS

CHARACTERISTIC	SYMBOL	TEST CONDITION	MIN	MAX	UNITS
SUPPLY VOLTAGE	$V_{cc}$		-0.5	11	V
OUTPUT VOLTAGE	$V_{out}$		-0.5	11	V
OUTPUT CURRENT	$I_{out}$	SOURCE OR SINK	10	10	mA
TEMPERATURE	$T_A$	OPERATING	-55	150	$^\circ\text{C}$
	$T_s$	STORAGE ( $V_{cc}=0$ )	-55	165	$^\circ\text{C}$

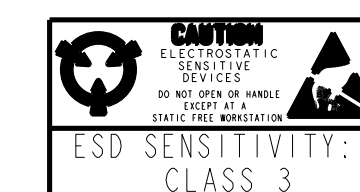
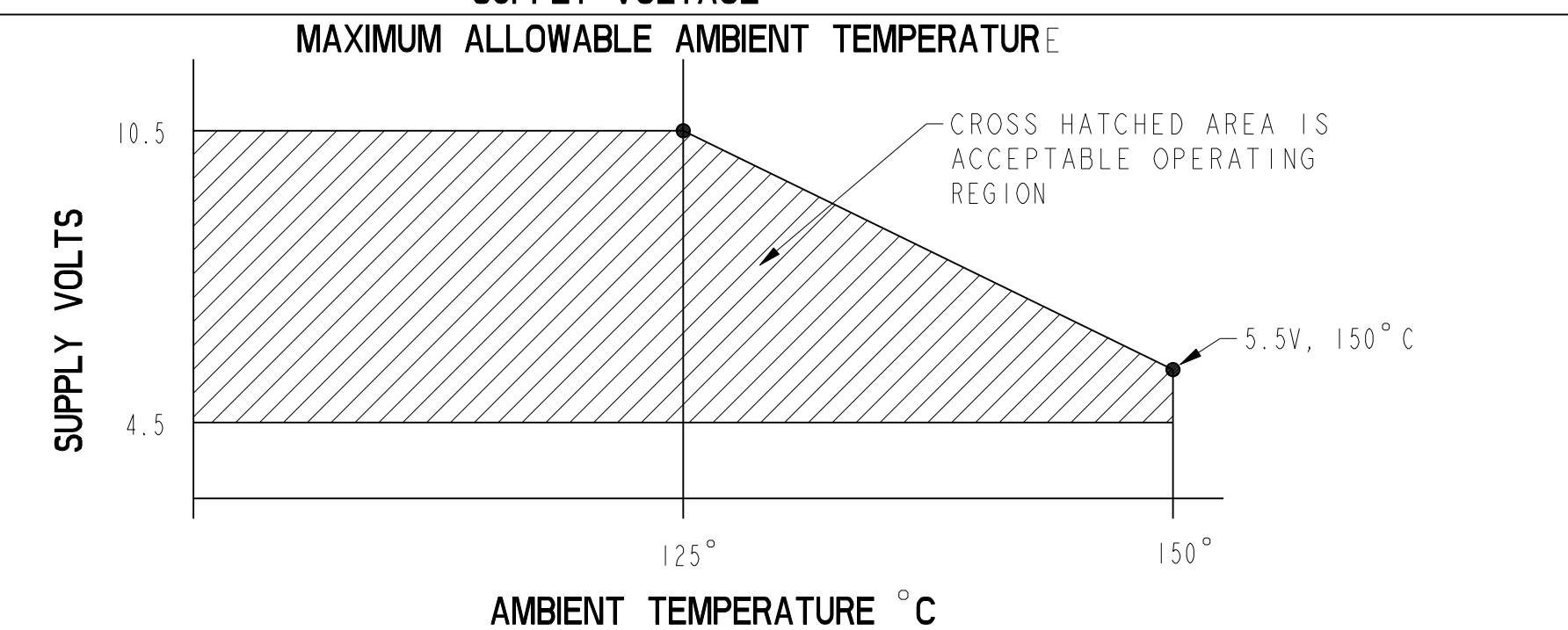
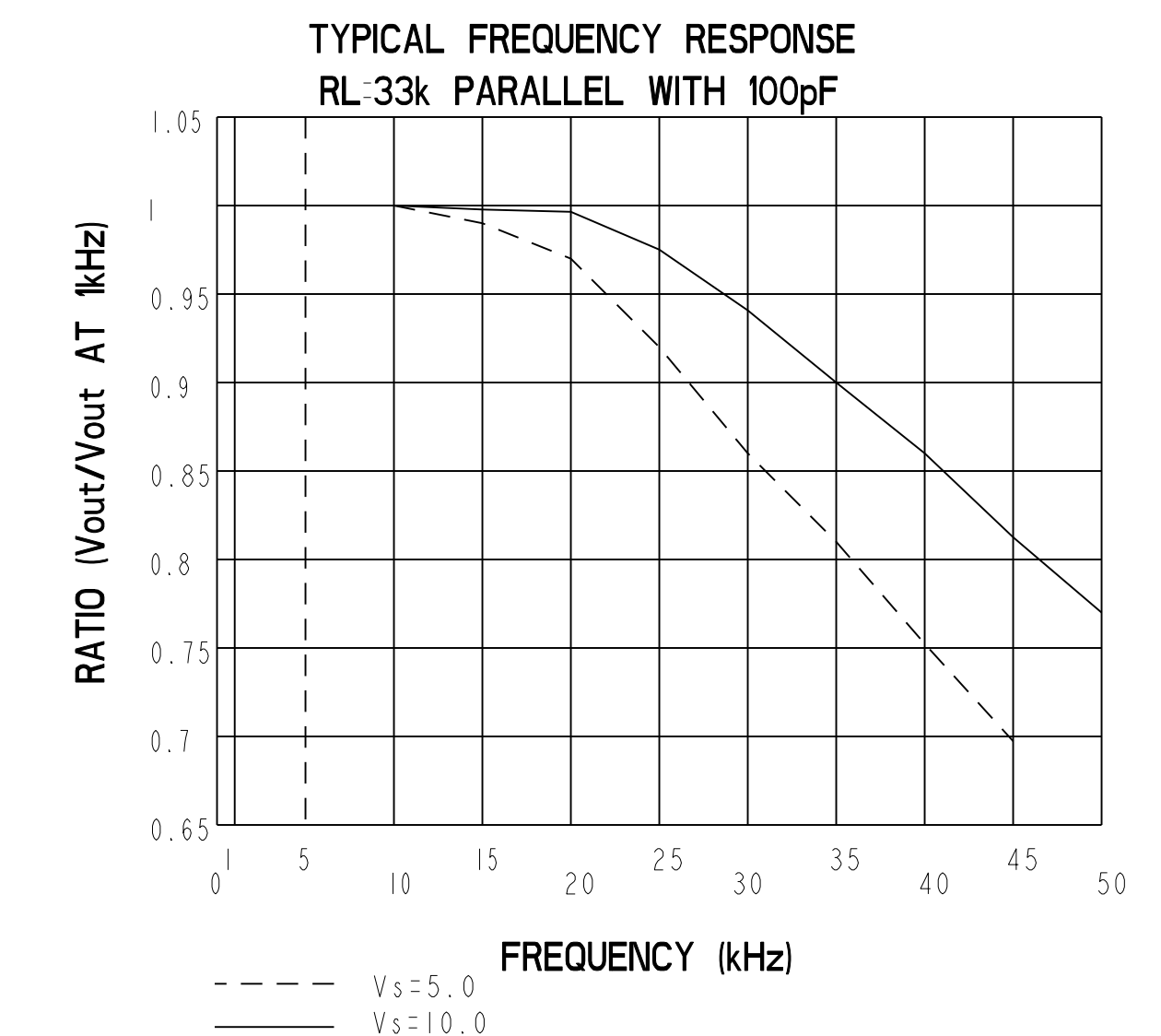
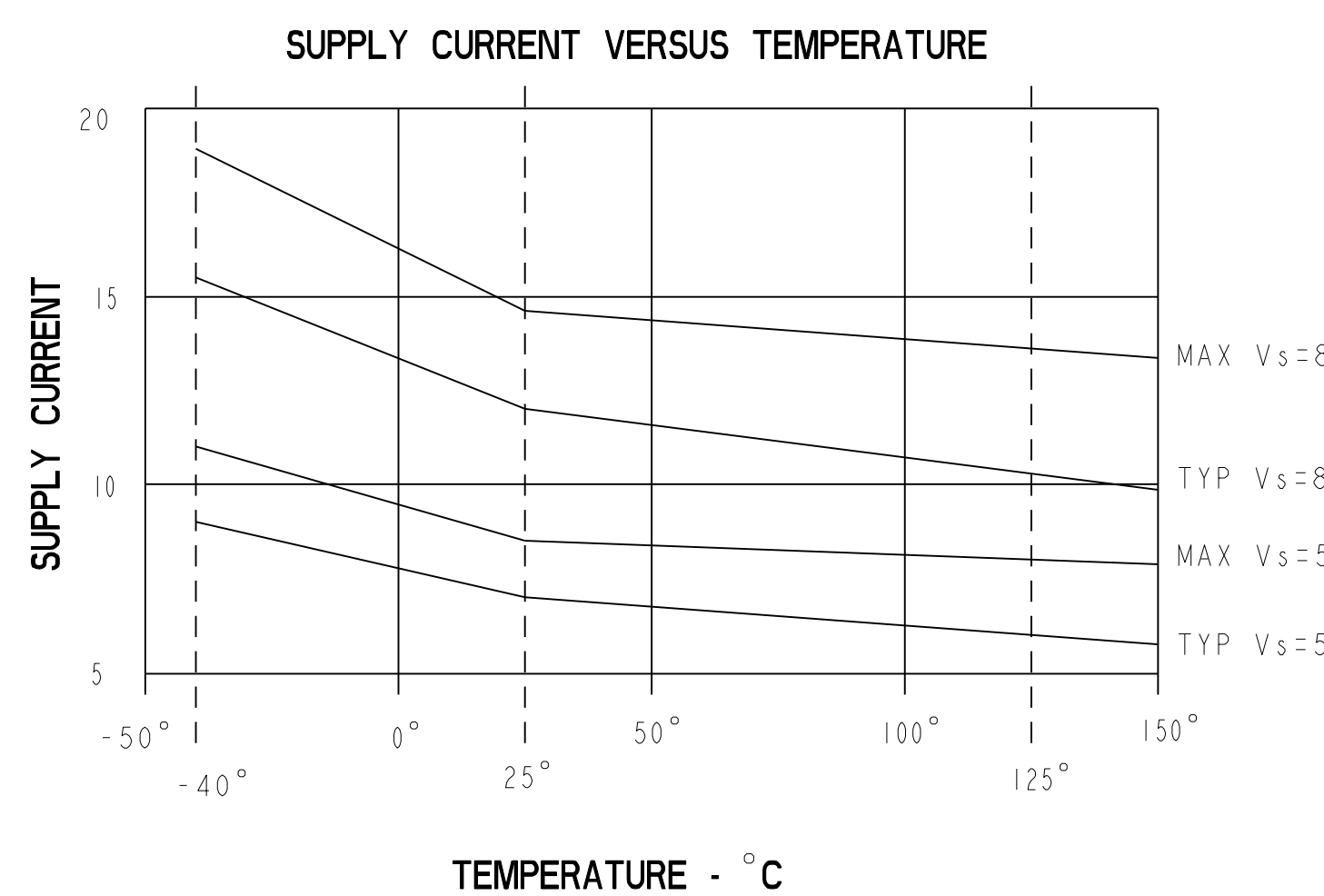
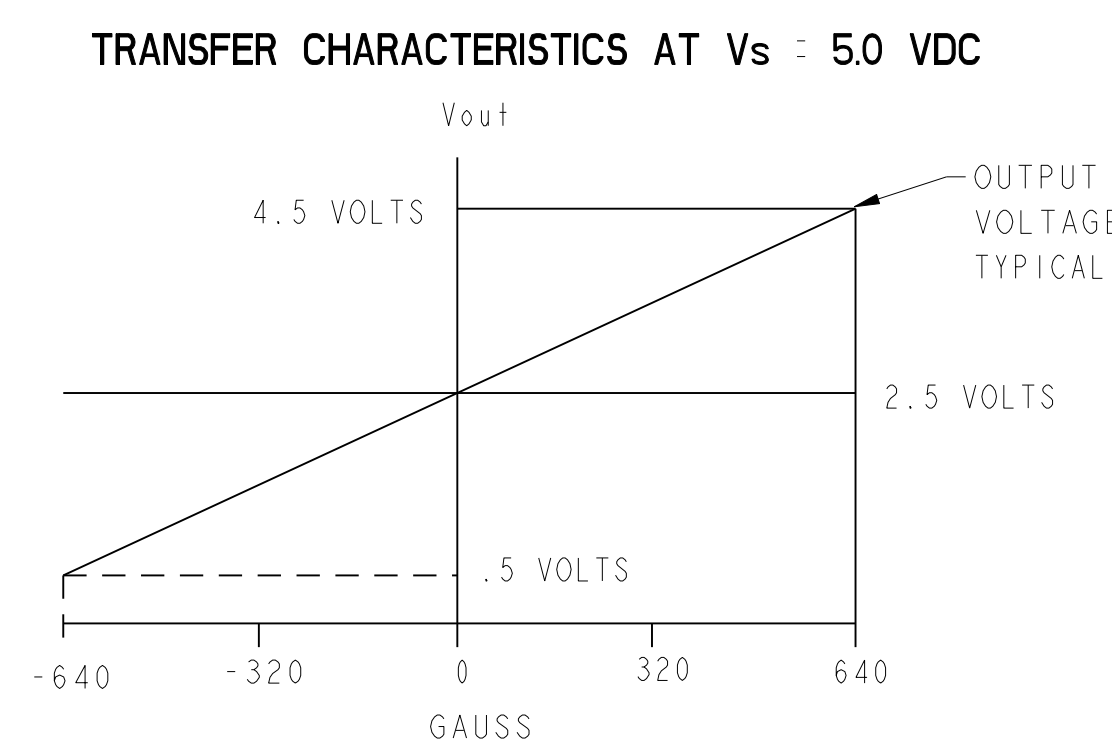
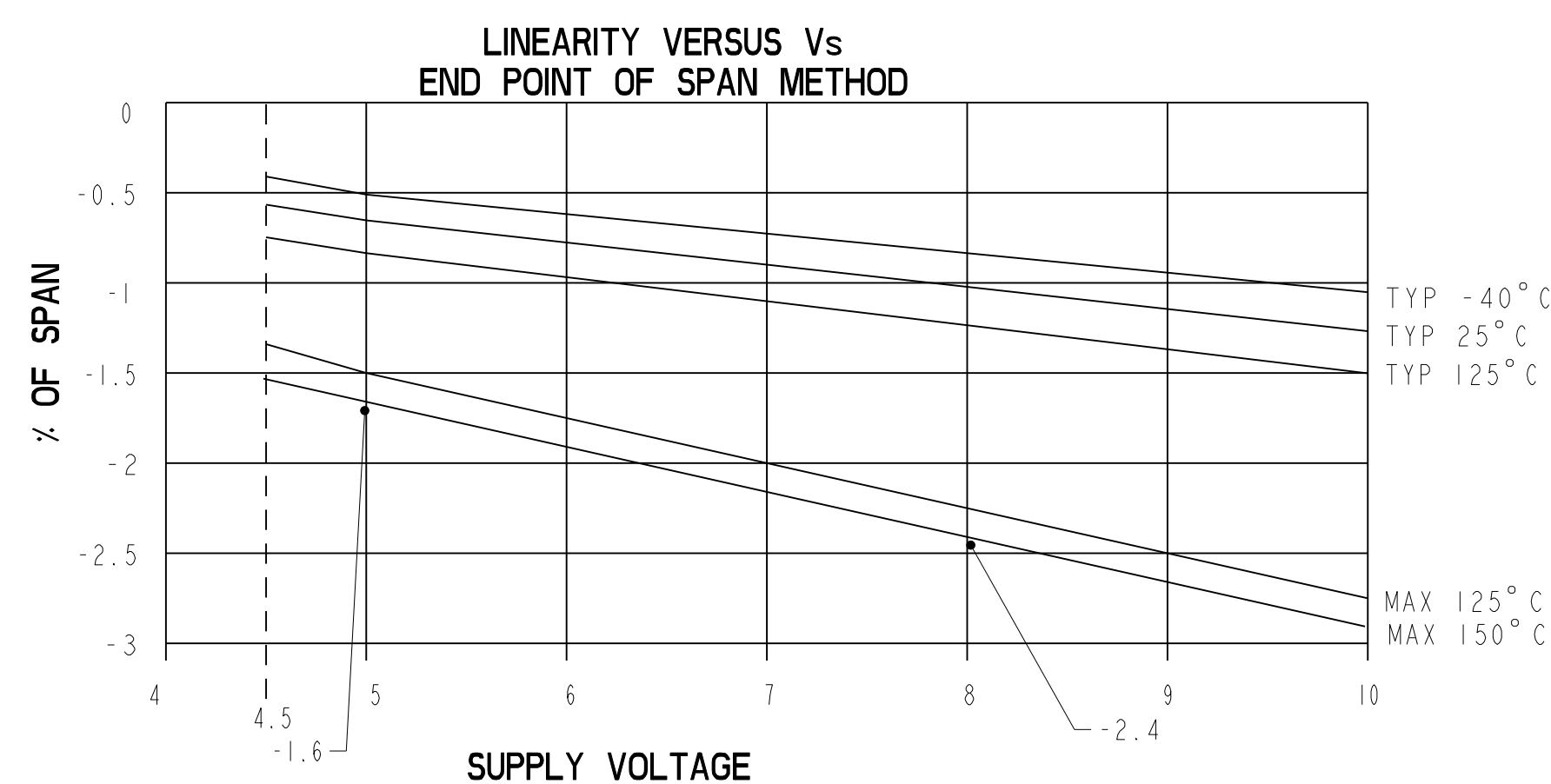
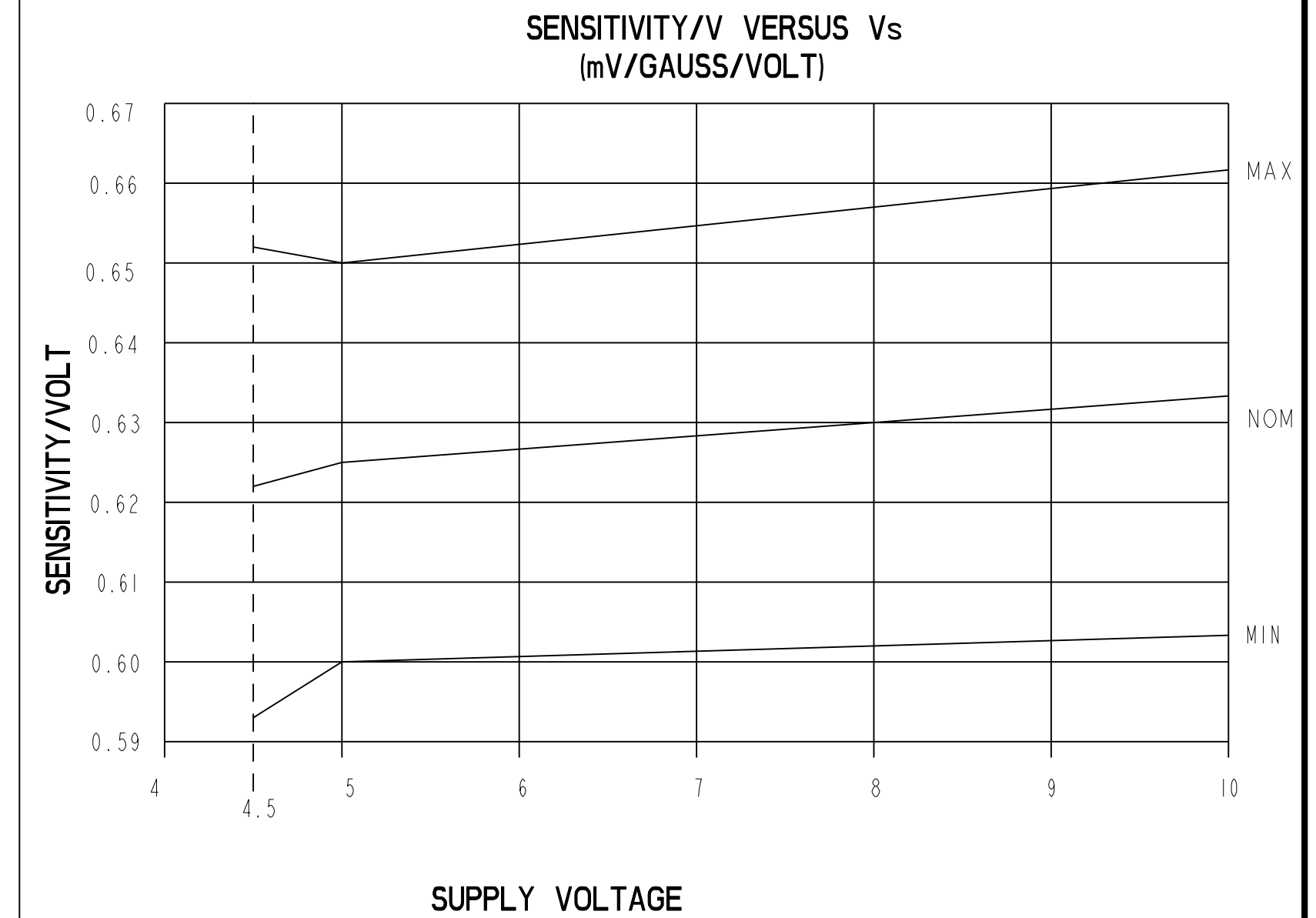
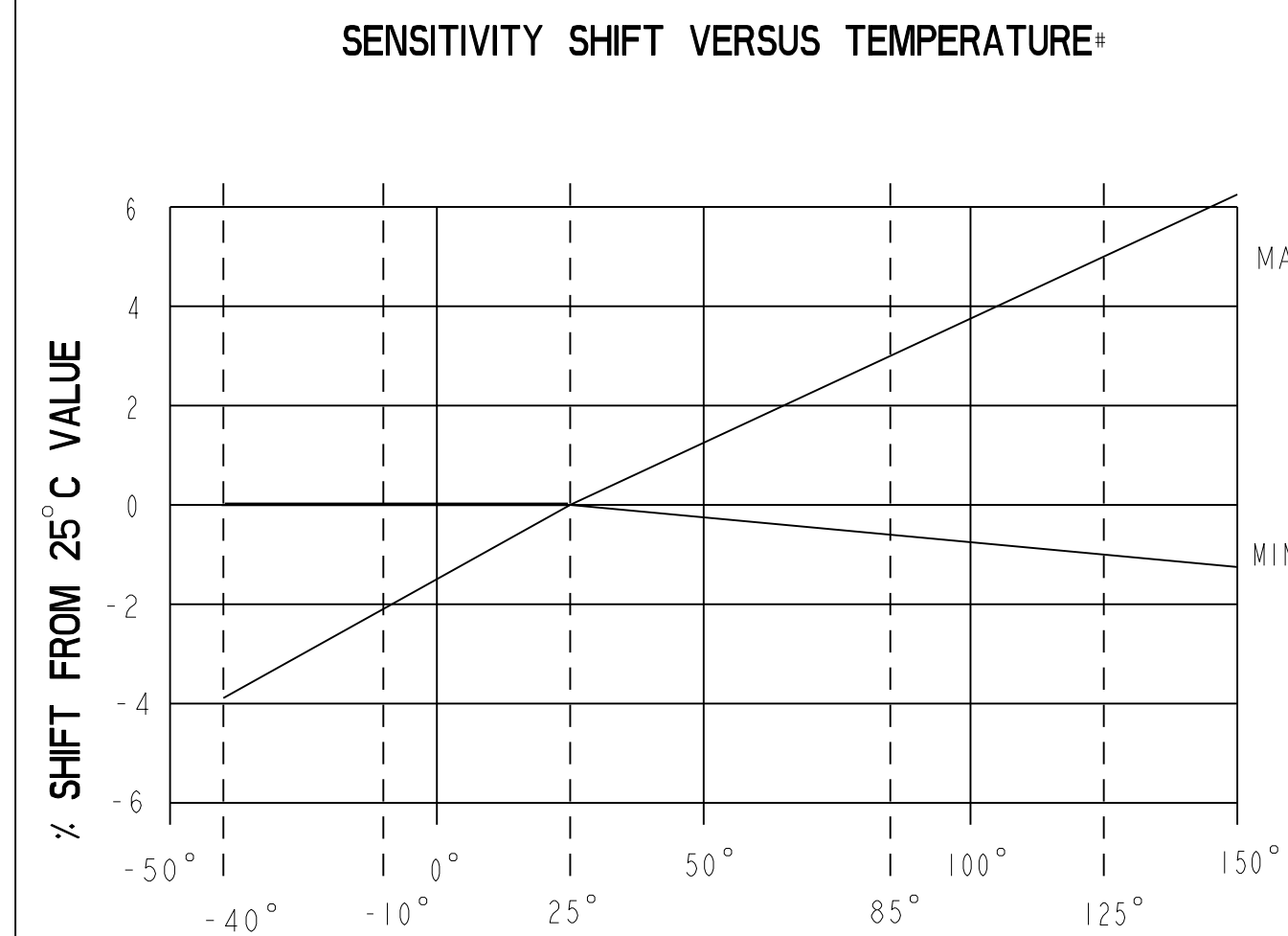
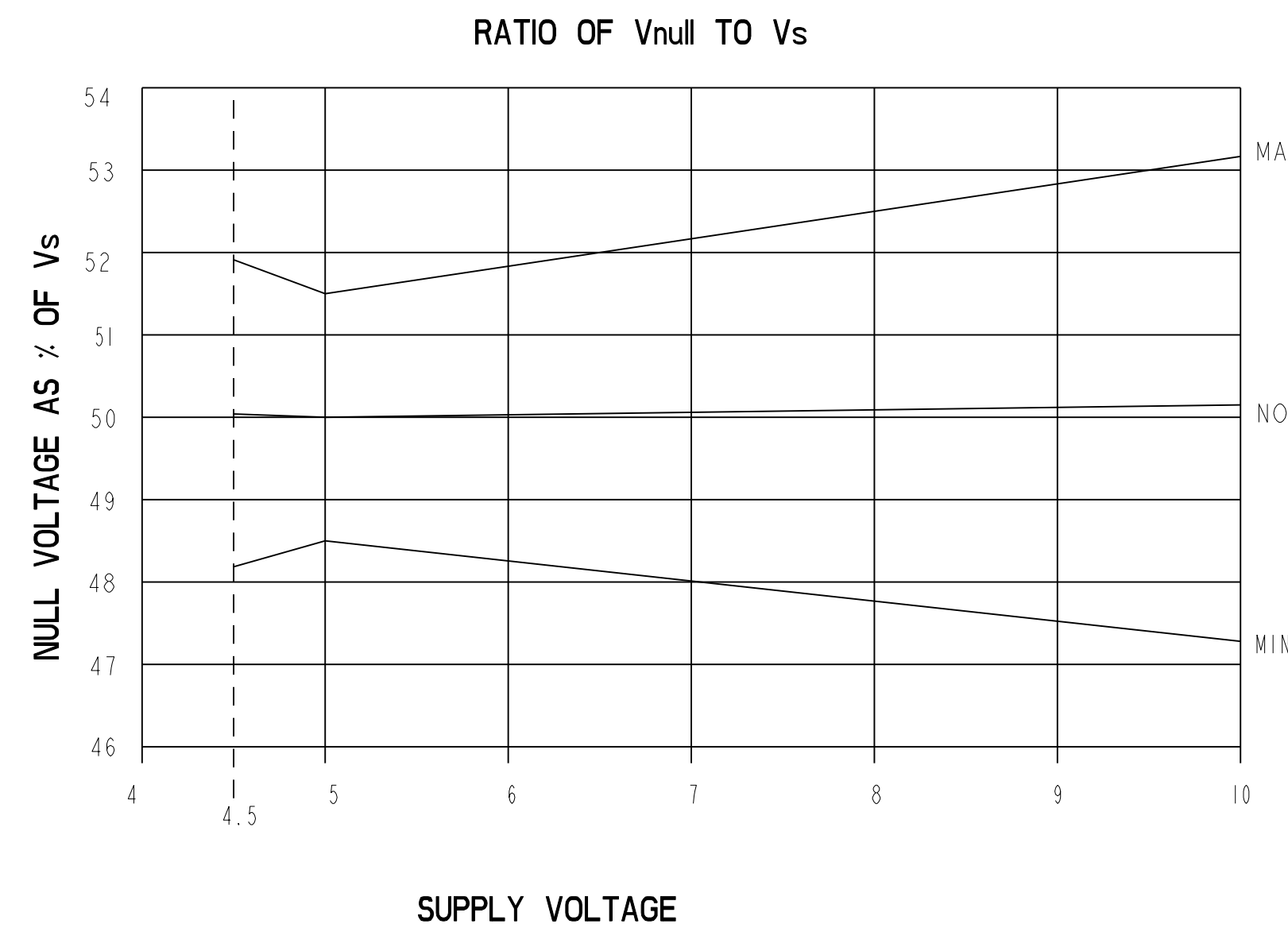
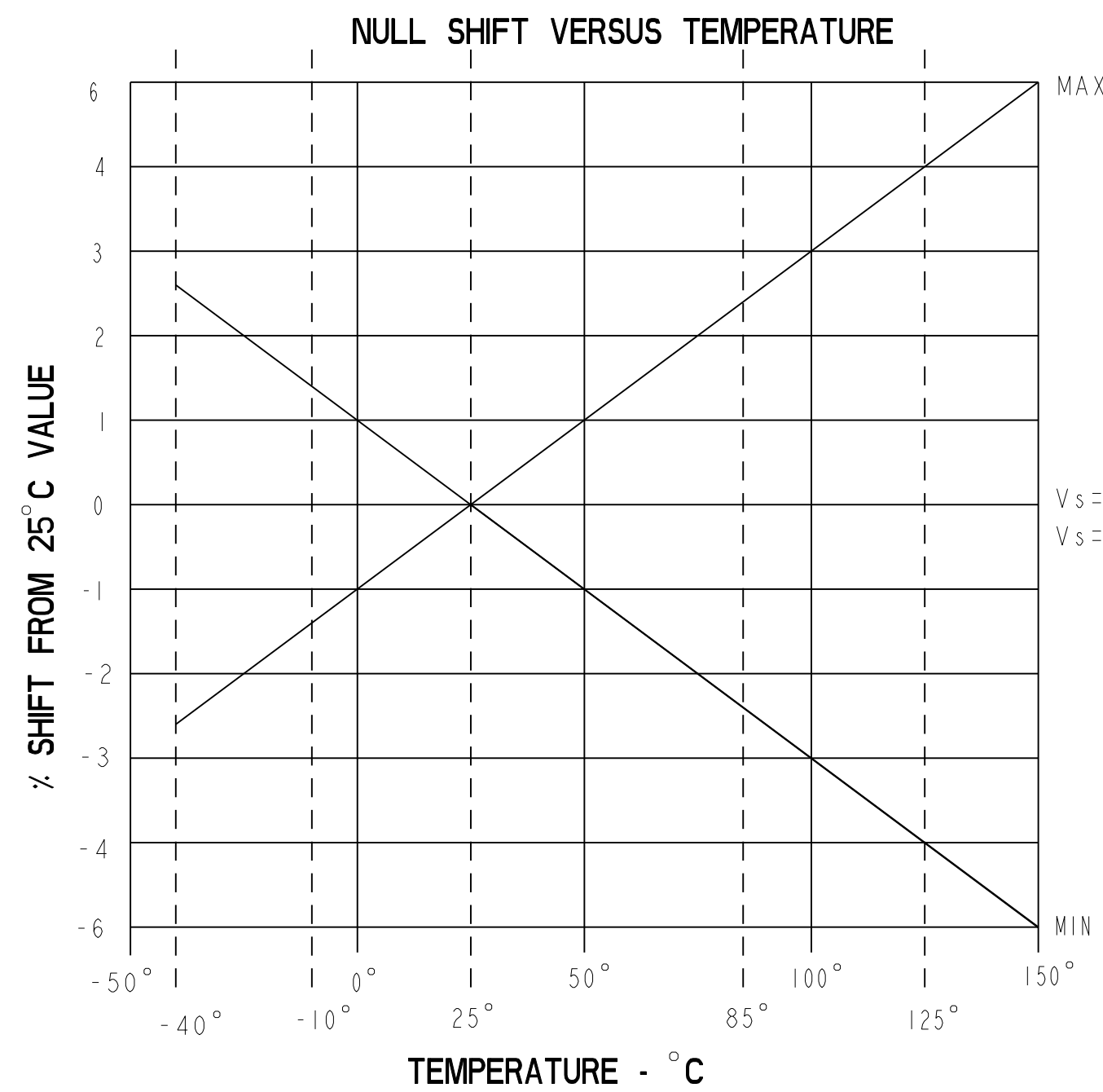

THIS DRAWING COVERS A PROPRIETARY ITEM AND IS THE PROPERTY OF MICRO SWITCH, A DIVISION OF HONEYWELL. THIS DRAWING IS NOT TO BE COPIED OR USED WITHOUT THE APPROVAL OF MICRO SWITCH.  
 FED. MFG. CODE 91929  
**MICRO SWITCH**  
 a Honeywell Division  
**MINIATURE RATIO-METRIC LINEAR HALL EFFECT SENSOR**  
 SS495 SERIES CHART 1  
 CATALOG LISTING

THIRD ANGLE PROJECTION	
SCALE	NONE
DO NOT SCALE PRINT	
UNLESS OTHERWISE SPECIFIED TOLERANCES ARE	
ONE PLACE	(.0) +.030
TWO PLACE	(.00) +.015
THREE PLACE	(.000) +.005
ANGLES	+2°
WEIGHT	

ANSI Y14.5M-1982 APPLIES

CHARACTERISTICS ARE AT  $V_s=5.00$  WITH 4.7K OUTPUT TO MINUS WITH  $T_A: -40^{\circ}\text{C}$  TO  $+125^{\circ}\text{C}$  UNLESS OTHERWISE SPECIFIED

SS495A2

SS495 SERIES CHART 1

PARAMETER	CONDITIONS	MIN	TYP	MAX	UNITS
SENSITIVITY	$T_A = 25^{\circ}\text{C}$	2.969	3.125	3.281	mV/GAUSS
NULL	$T_A = 25^{\circ}\text{C}$	2.400	2.50	2.600	VOLTS
SUPPLY CURRENT	$T_A = 25^{\circ}\text{C}$		7	8.7	mA
OUTPUT CURRENT SOURCE	$V_s > 4.5$	1mA	1.5mA		
SINK	$V_s > 4.5$	.6mA	1.5mA		
SINK	$V_s > 5.0$	1mA	1.5mA		
RESPONSE TIME			3 $\mu\text{s}$		
OUTPUT VOLTAGE SWING					
VOM -	-B APPLIED	.4	.2		VOLTS
VOM +	+B APPLIED	$V_s - .4$	$V_s - .2$		VOLTS
B LIMITS FOR LINEAR OPERATION					
-B MAX		-600	-670		GAUSS
+B MAX		+600	+670		GAUSS
$V_{null}$ DRIFT	$B = 0, T_A = 25^{\circ}\text{C}$ TO $125^{\circ}\text{C}$	-.07		+.07	% / $^{\circ}\text{C}$
$V_{null}$ DRIFT	$B = 0, T_A = +125^{\circ}\text{C}$ TO $+150^{\circ}\text{C}$	-.08		+.08	% / $^{\circ}\text{C}$
SENSITIVITY DRIFT	$T_A = +25^{\circ}\text{C}$ TO $+150^{\circ}\text{C}$	-.02		+.06	% / $^{\circ}\text{C}$
SENSITIVITY DRIFT	$T_A = -40^{\circ}\text{C}$ TO $+25^{\circ}\text{C}$	-.01		+.07	% / $^{\circ}\text{C}$
LINEARITY	$B = -600$ TO $+600$	0	-1.0	-1.5	% OF SPAN
SUPPLY VOLTAGE	$-40^{\circ}\text{C}$ TO $+125^{\circ}\text{C}$	4.5	5.0	10.5	VOLTS
OPERATING TEMP	SEE MAX TEMPERATURE CHART	-40		+150	$^{\circ}\text{C}$

BLOCK DIAGRAM CURRENT SINKING OR SOURCING OUTPUT

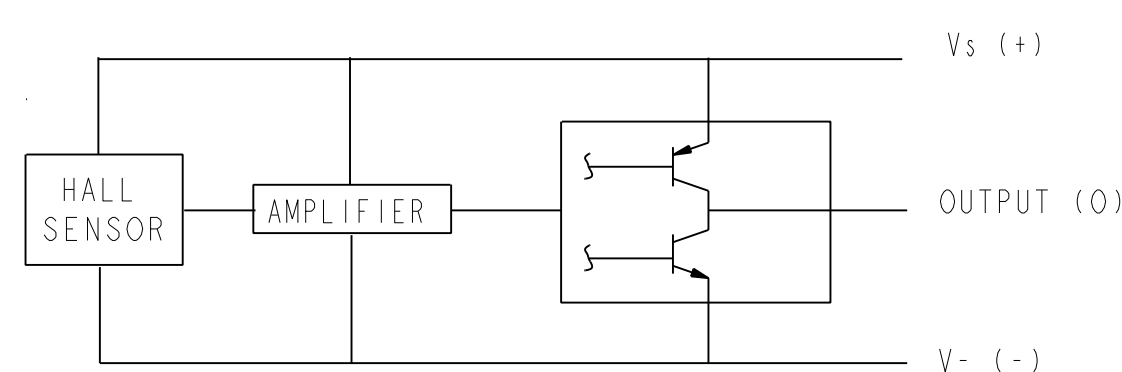

ABSOLUTE MAXIMUM CHARACTERISTICS

CHARACTERISTIC	SYMBOL	TEST CONDITION	MIN	MAX	UNITS
SUPPLY VOLTAGE	$V_{cc}$		-0.5	11	V
OUTPUT VOLTAGE	$V_{out}$		-0.5	11	V
OUTPUT CURRENT	$I_{out}$	SOURCE OR SINK	10		mA
TEMPERATURE	$T_A$	OPERATING	-55	150	$^{\circ}\text{C}$
	$T_s$	STORAGE ( $V_{cc}=0$ )	-55	165	$^{\circ}\text{C}$

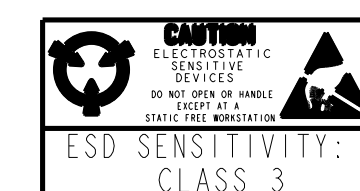
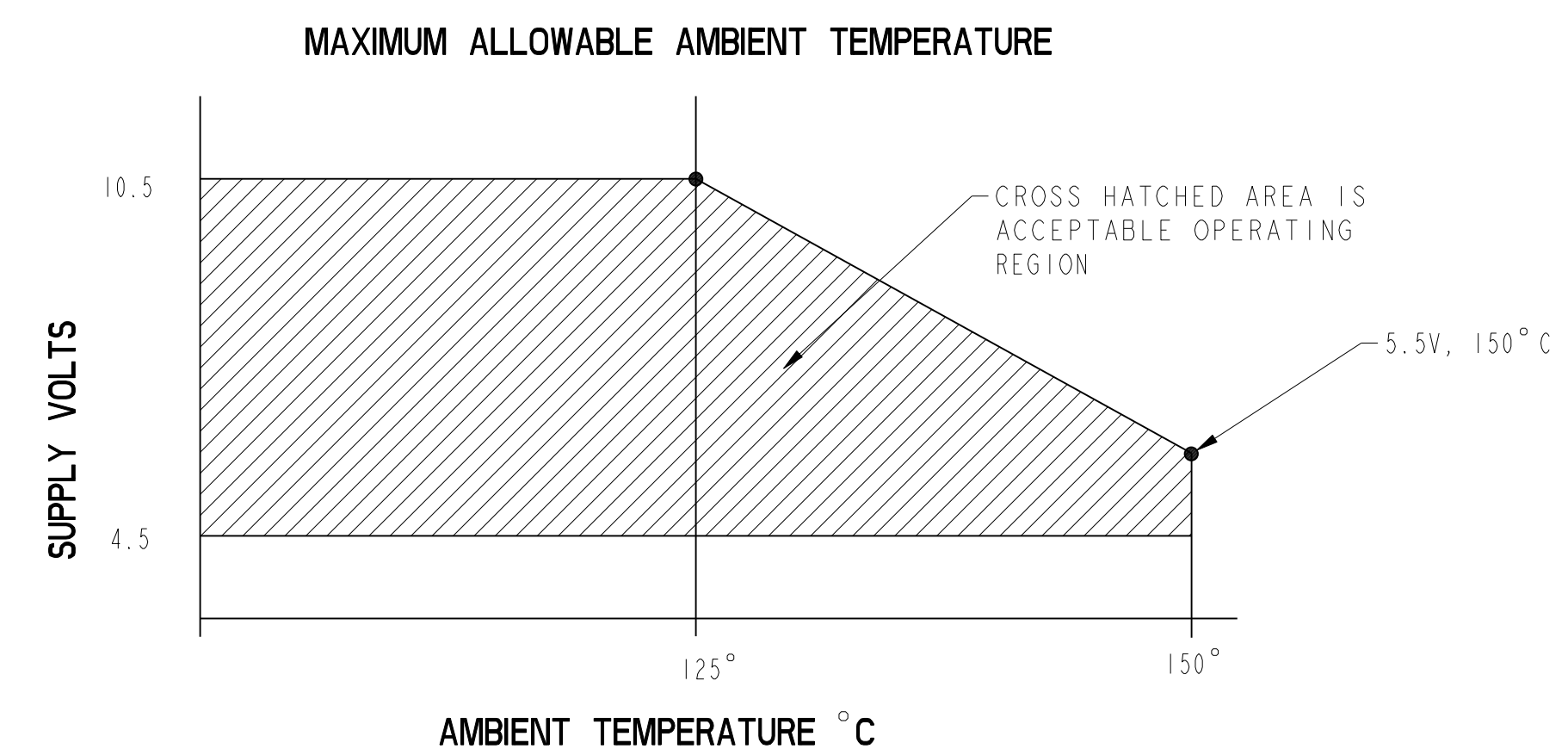
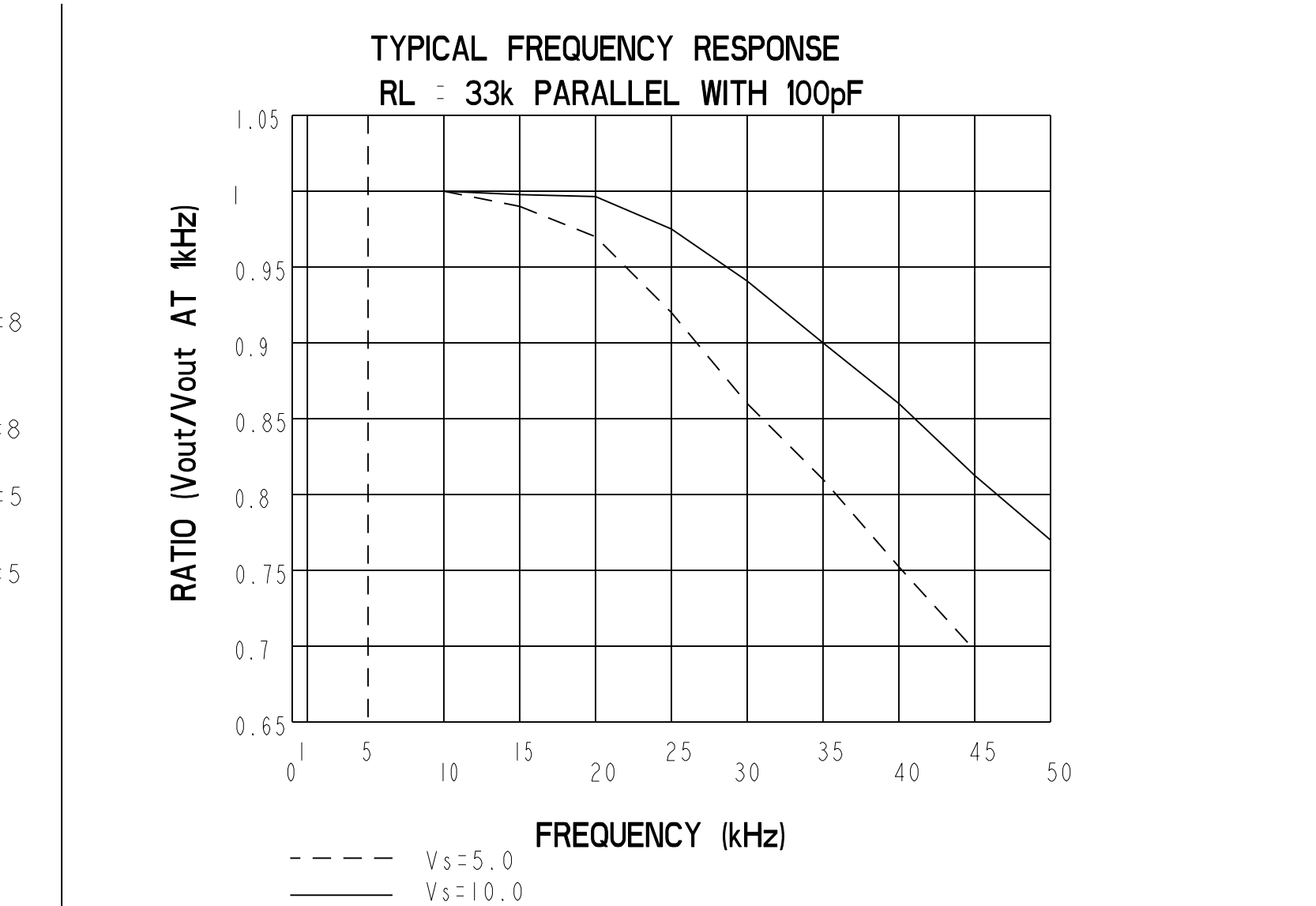
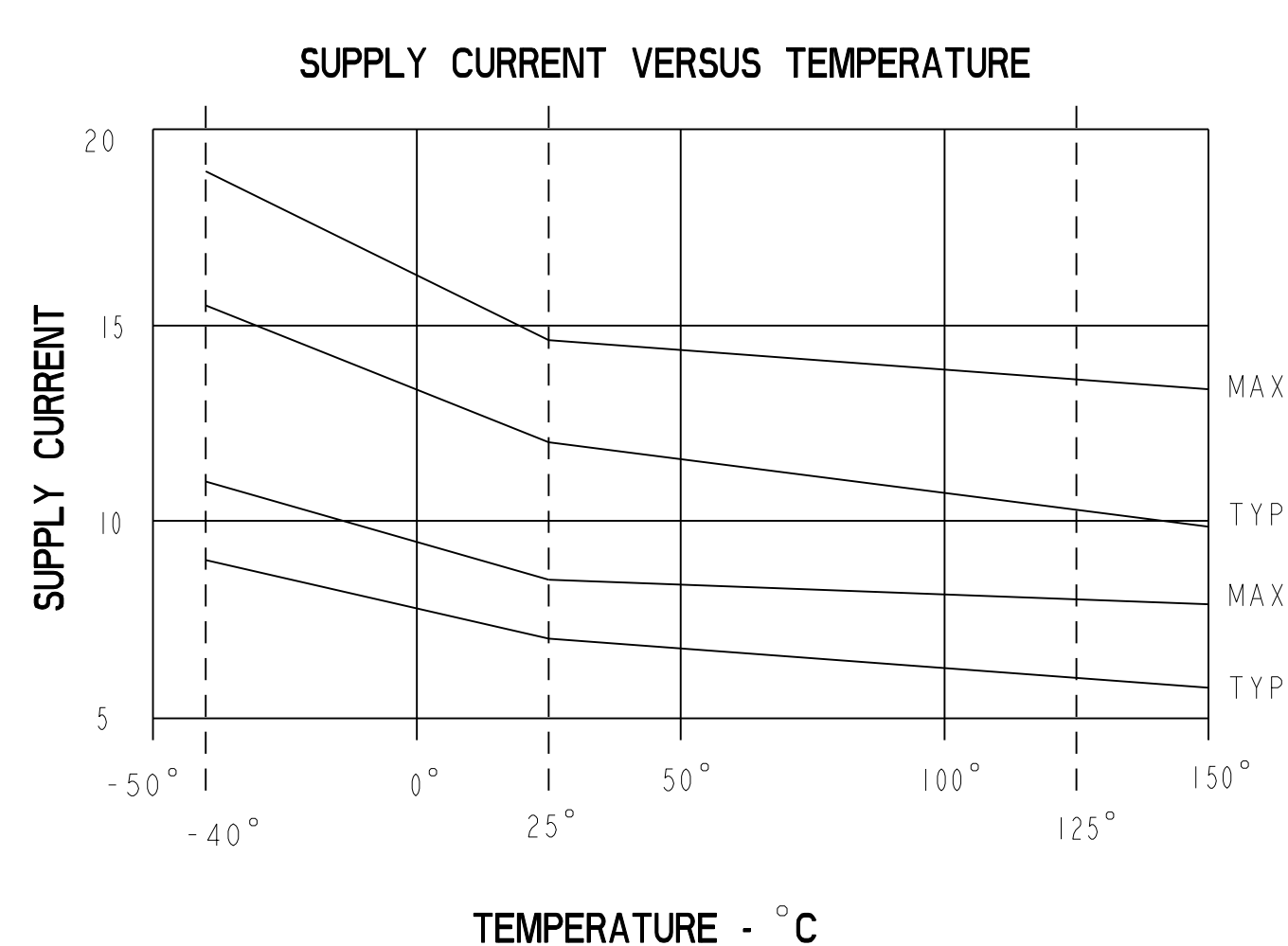
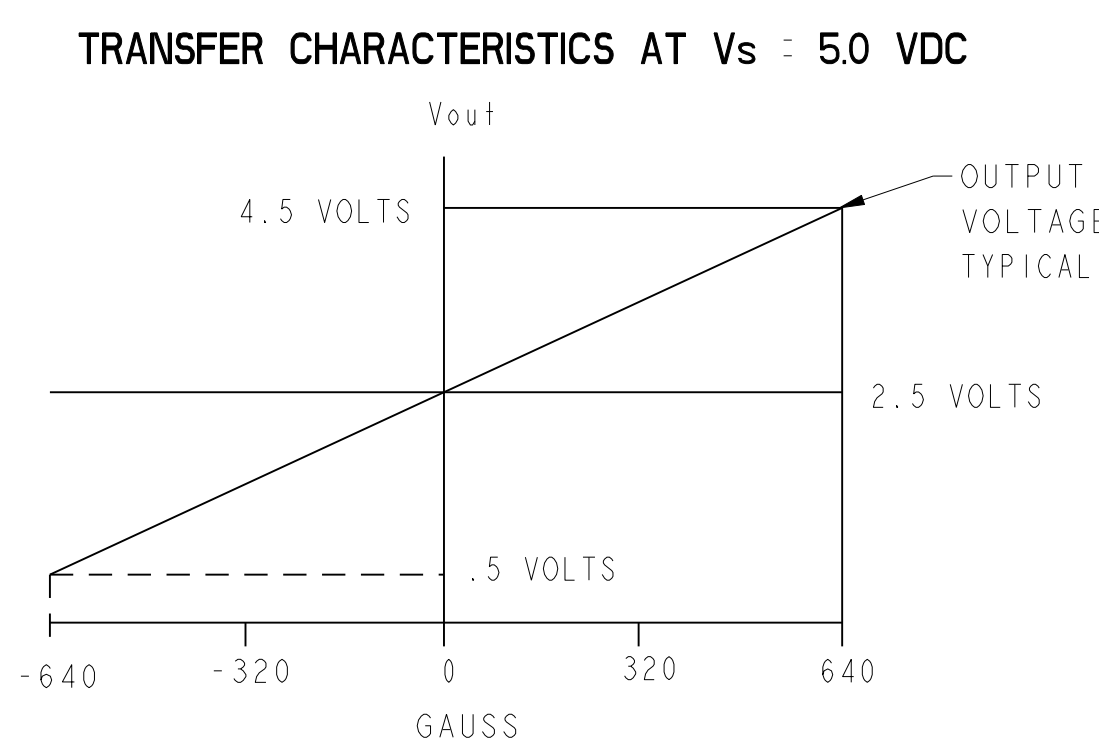
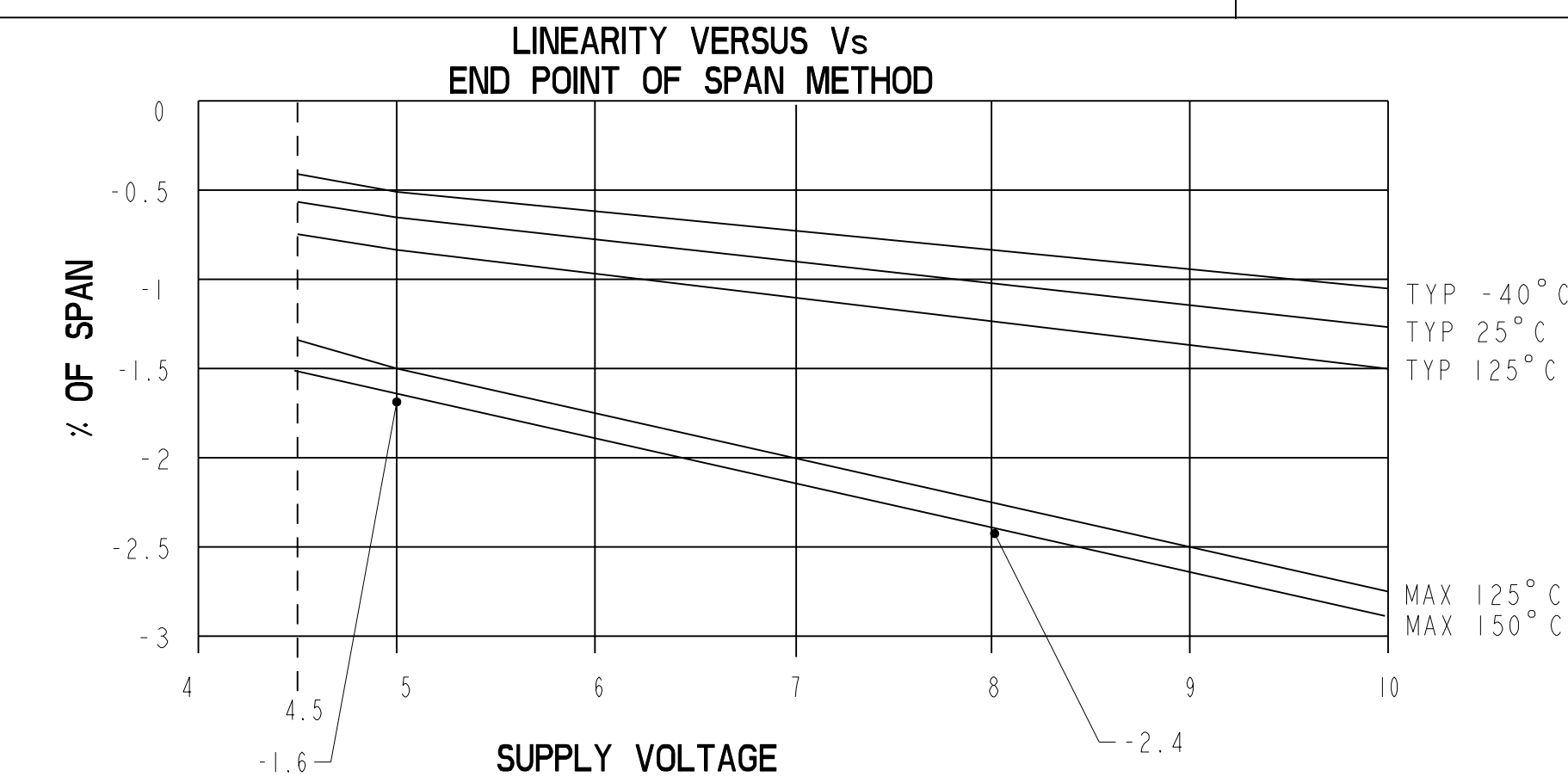
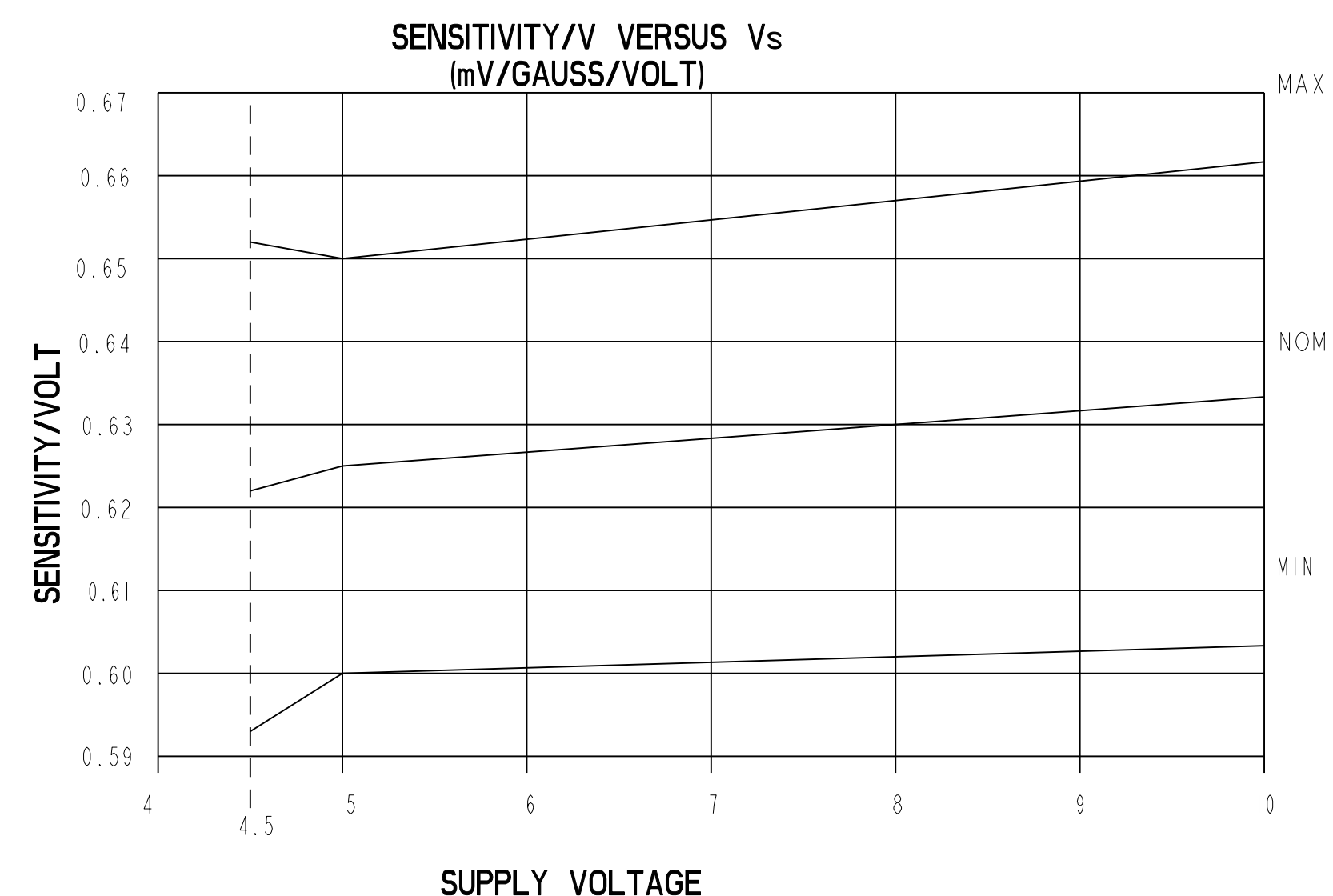
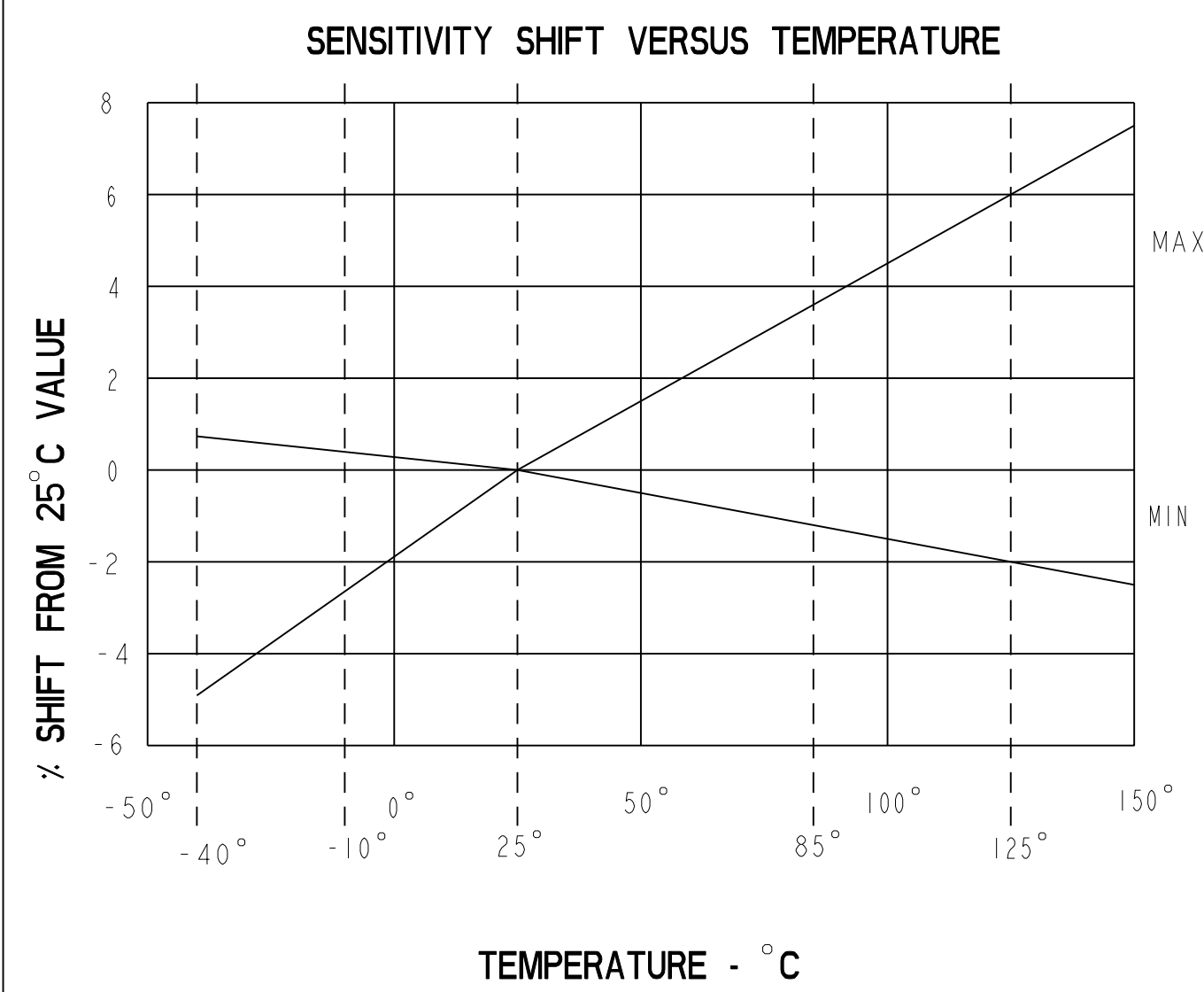
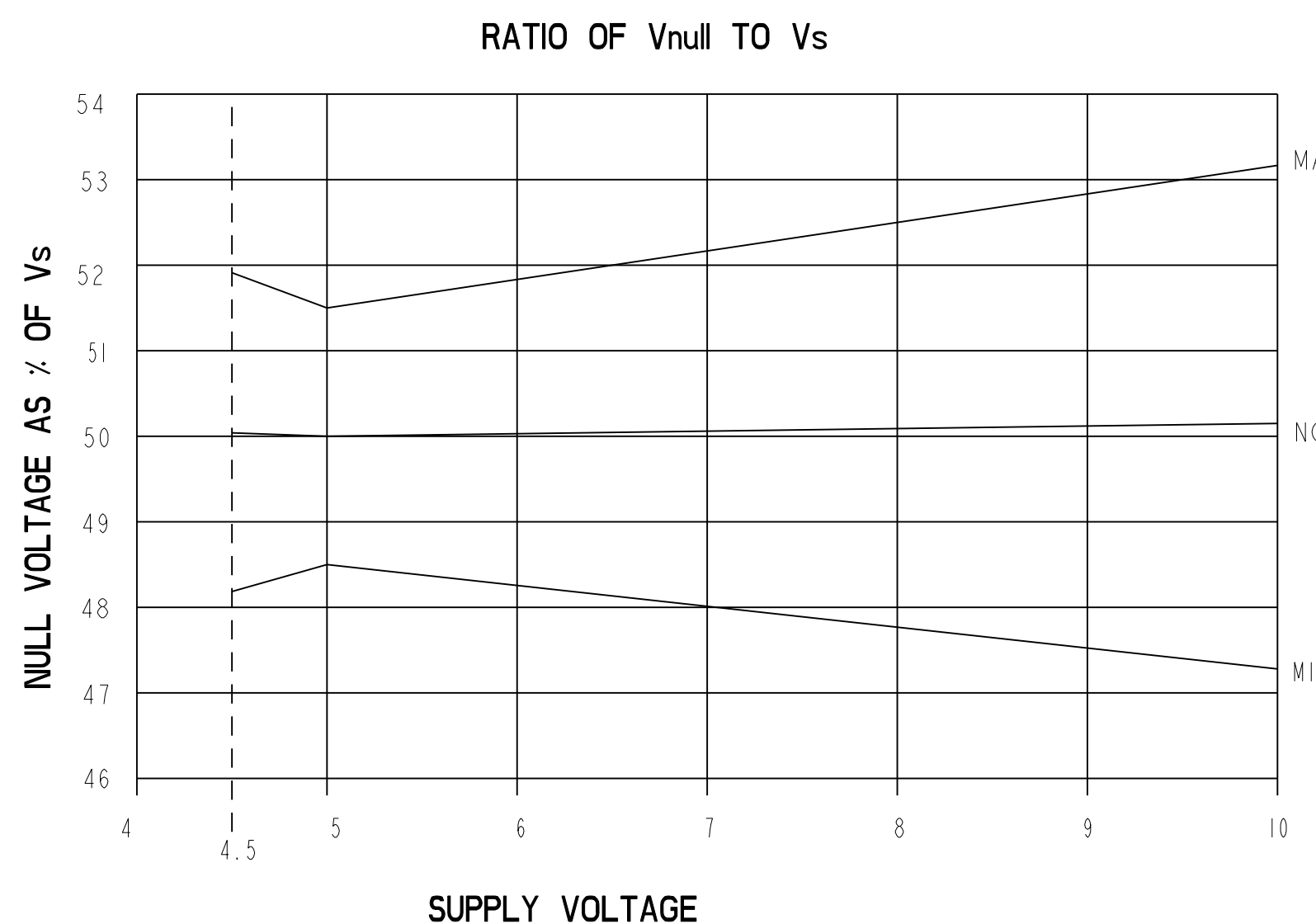
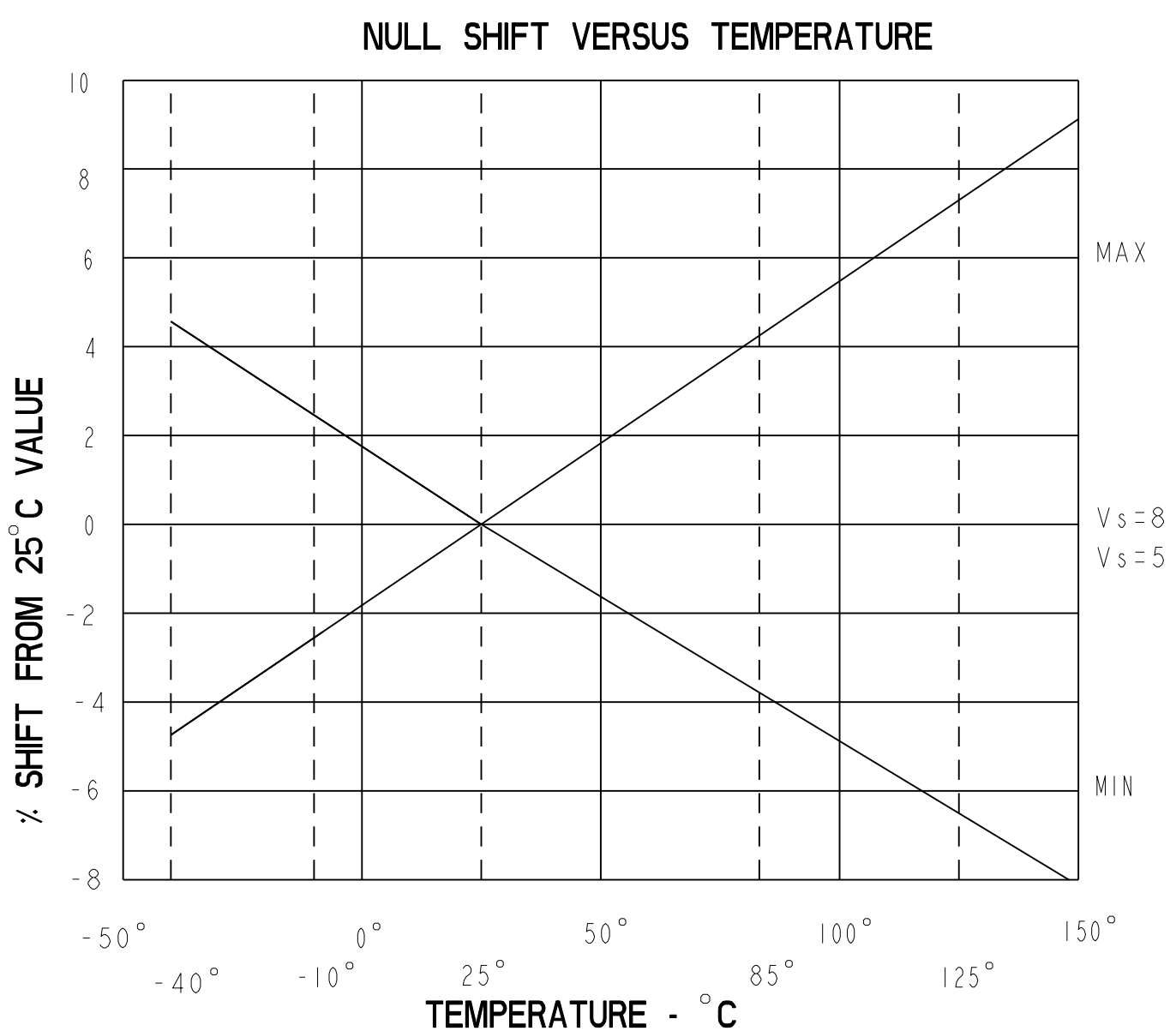

THIS DRAWING COVERS A PROPRIETARY ITEM AND IS THE PROPERTY OF MICRO SWITCH, A DIVISION OF HONEYWELL. THIS DRAWING IS NOT TO BE COPIED OR USED WITHOUT THE APPROVAL OF MICRO SWITCH.

FED. MFG. CODE 91929

**MICRO SWITCH**  
a Honeywell Division

**MINIATURE RATIO-METRIC LINEAR HALL EFFECT SENSOR**

SS495 SERIES CHART 1

CATALOG LISTING

ONE PLACE	(.0)	+ .030
TWO PLACE	(.00)	+ .015
THREE PLACE	(.000)	+ .005
ANGLES		+ 2°
WEIGHT		

PTC/CAD 20  
 DRAWN: C.S.L. 15 APR 02  
 CHECK: SAV 5 APR 02  
 RELEASE NO. PR-22532  
 SS495 SERIES CHART 1  
 DRAWING NUMBER: 4 OF 5  
 ISSUE: 14  
 DATE: 26 OCT 01  
 HONEYWELL

CHARACTERISTICS ARE AT  $V_s=5.00$  WITH 4.7K OUTPUT TO MINUS WITH  $T_A: -40^\circ\text{C}$  TO  $+125^\circ\text{C}$  UNLESS OTHERWISE SPECIFIED

SS495B

SS495 SERIES CHART 1

PARAMETER	CONDITIONS	MIN	TYP	MAX	UNITS
SENSITIVITY	$T_A = 25^\circ\text{C}$	2.875	3.125	3.375	mV/GAUSS
NULL	$T_A = 25^\circ\text{C}$	2.35	2.50	2.650	VOLTS
SUPPLY CURRENT	$T_A = 25^\circ\text{C}$		7	8.7	mA
OUTPUT CURRENT SOURCE	$V_s > 4.5$	1mA	1.5mA		
SINK	$V_s > 4.5$		.6mA	1.5mA	
SINK	$V_s > 5.0$	1mA	1.5mA		
RESPONSE TIME			3μS		
OUTPUT VOLTAGE SWING					
VOM -	-B APPLIED	.4	.2		VOLTS
VOM +	+B APPLIED	$V_s - .4$	$V_s - .2$		VOLTS
B LIMITS FOR LINEAR OPERATION					GAUSS
	-B MAX	-600	-670		
	+B MAX	+600	+670		
$V_{null}$ DRIFT	$B = 0, T_A = 25^\circ\text{C}$ TO $125^\circ\text{C}$	-.08		+.08	% / °C
$V_{null}$ DRIFT	$B = 0, T_A = +125^\circ\text{C}$ TO $+150^\circ\text{C}$	-.08		+.08	% / °C
SENSITIVITY DRIFT	$T_A = +25^\circ\text{C}$ TO $+150^\circ\text{C}$	-.02		+.08	% / °C
SENSITIVITY DRIFT	$T_A = -40^\circ\text{C}$ TO $+25^\circ\text{C}$	-.02		+.08	% / °C
LINEARITY	$B = -600$ TO $+600$	0	-1.0	-1.5	% OF SPAN
SUPPLY VOLTAGE	$-40^\circ\text{C}$ TO $+125^\circ\text{C}$	4.5	5.0	10.5	VOLTS
OPERATING TEMP	SEE MAX TEMPERATURE CHART	-40		+150	°C

BLOCK DIAGRAM CURRENT SINKING OR SOURCING OUTPUT

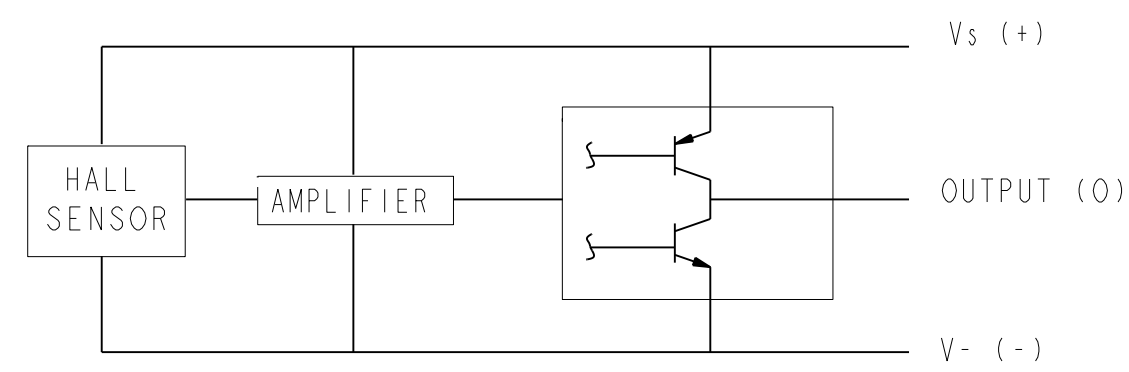

ABSOLUTE MAXIMUM CHARACTERISTICS

CHARACTERISTIC	SYMBOL	TEST CONDITION	MIN	MAX	UNITS
SUPPLY VOLTAGE	$V_{cc}$		-0.5	11	V
OUTPUT VOLTAGE	$V_{out}$		-0.5	11	V
OUTPUT CURRENT	$I_{out}$	SOURCE OR SINK	10		mA
TEMPERATURE	$T_A$	OPERATING	-55	150	°C
	$T_s$	STORAGE ( $V_{cc}=0$ )	-55	165	°C

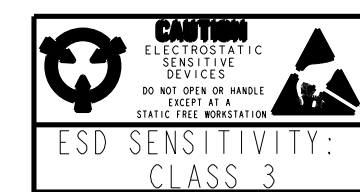
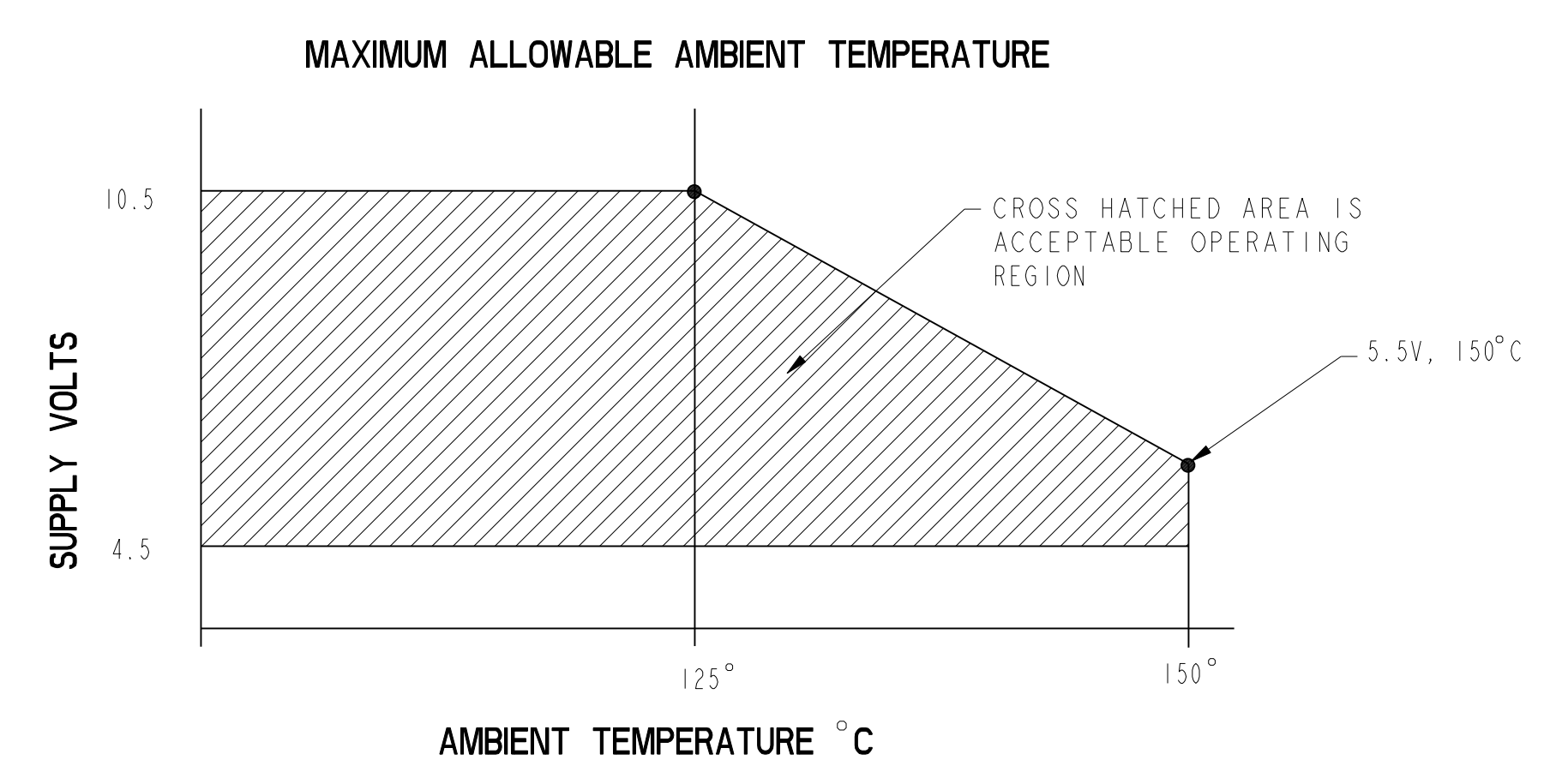
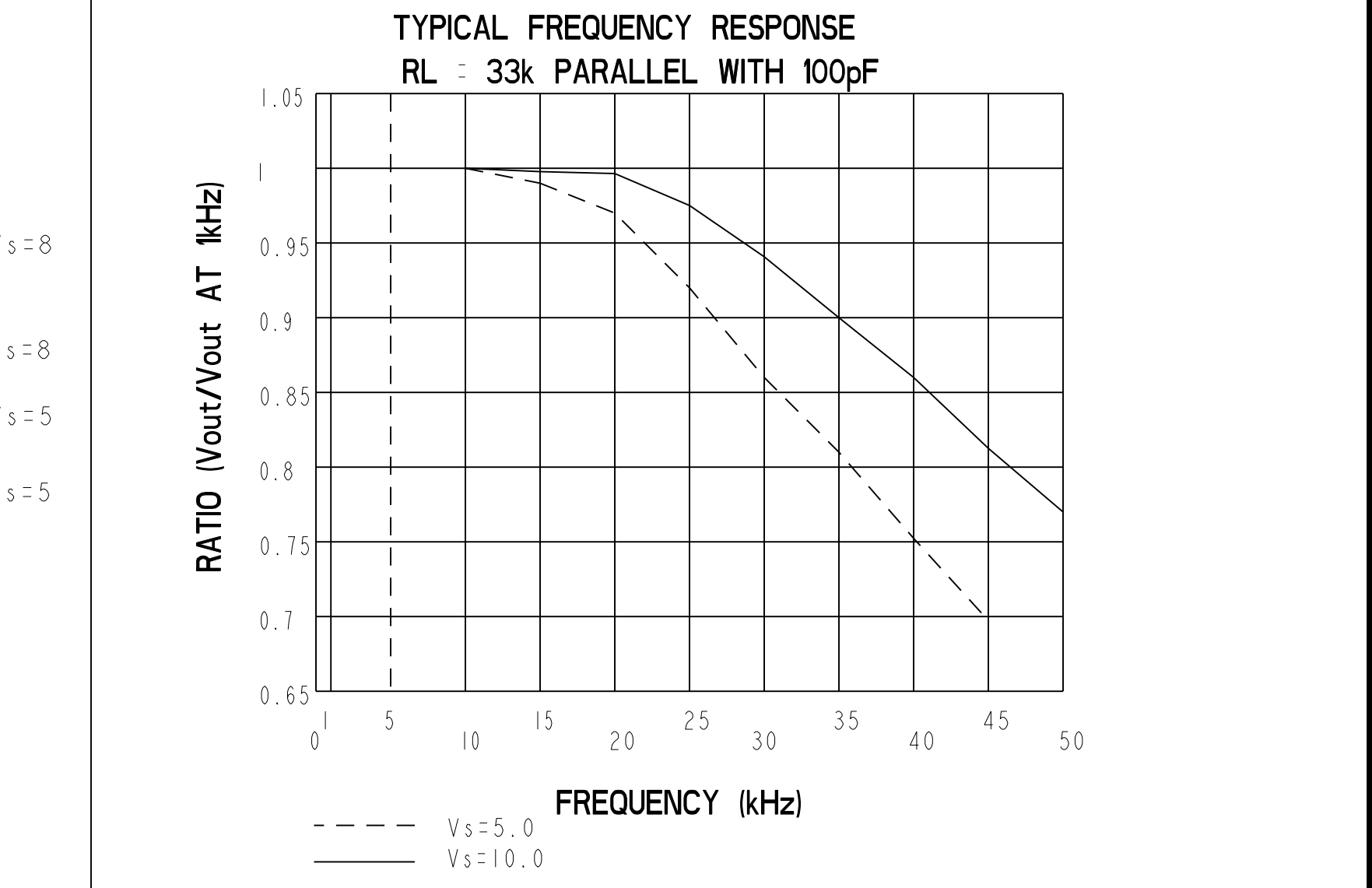
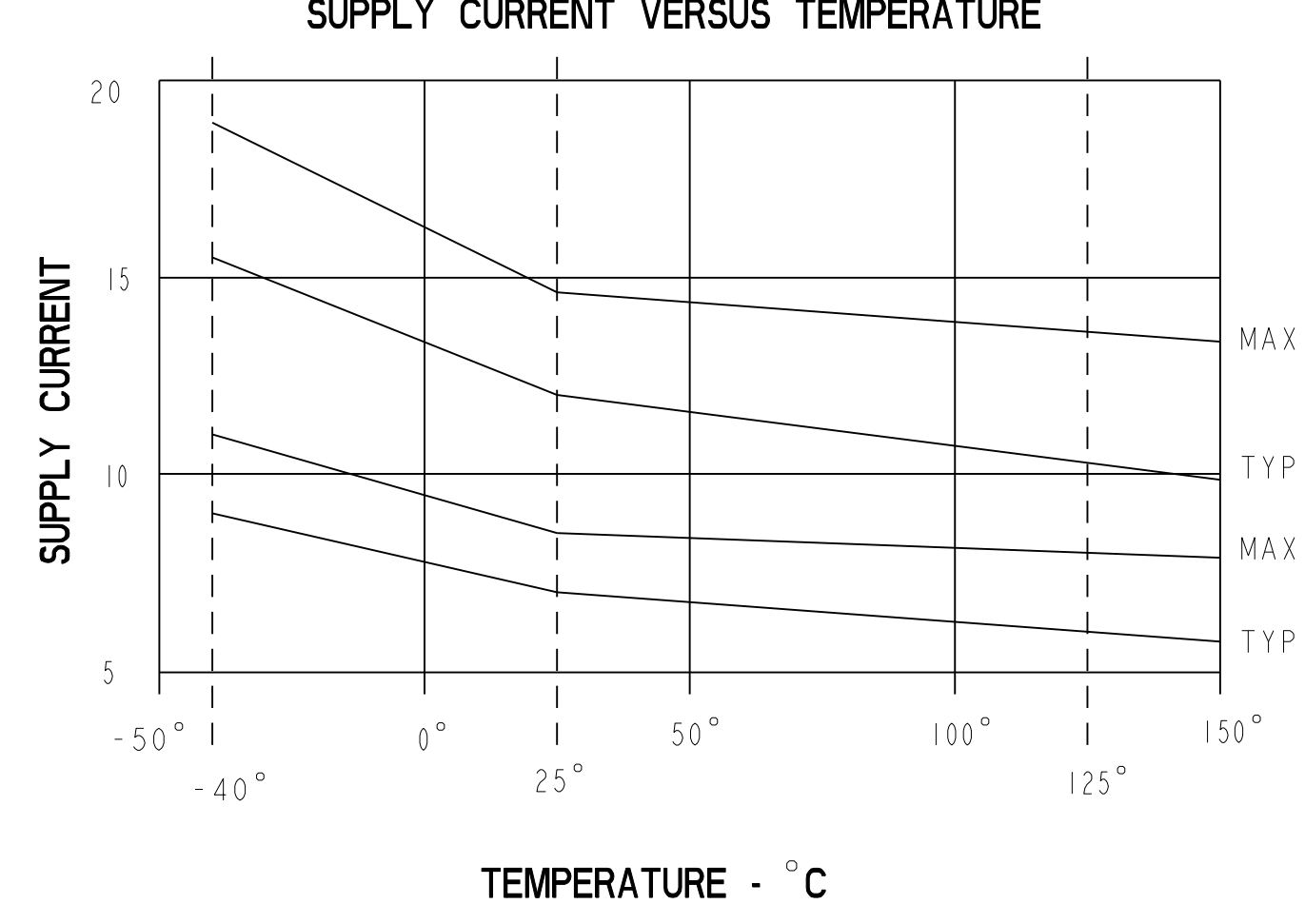
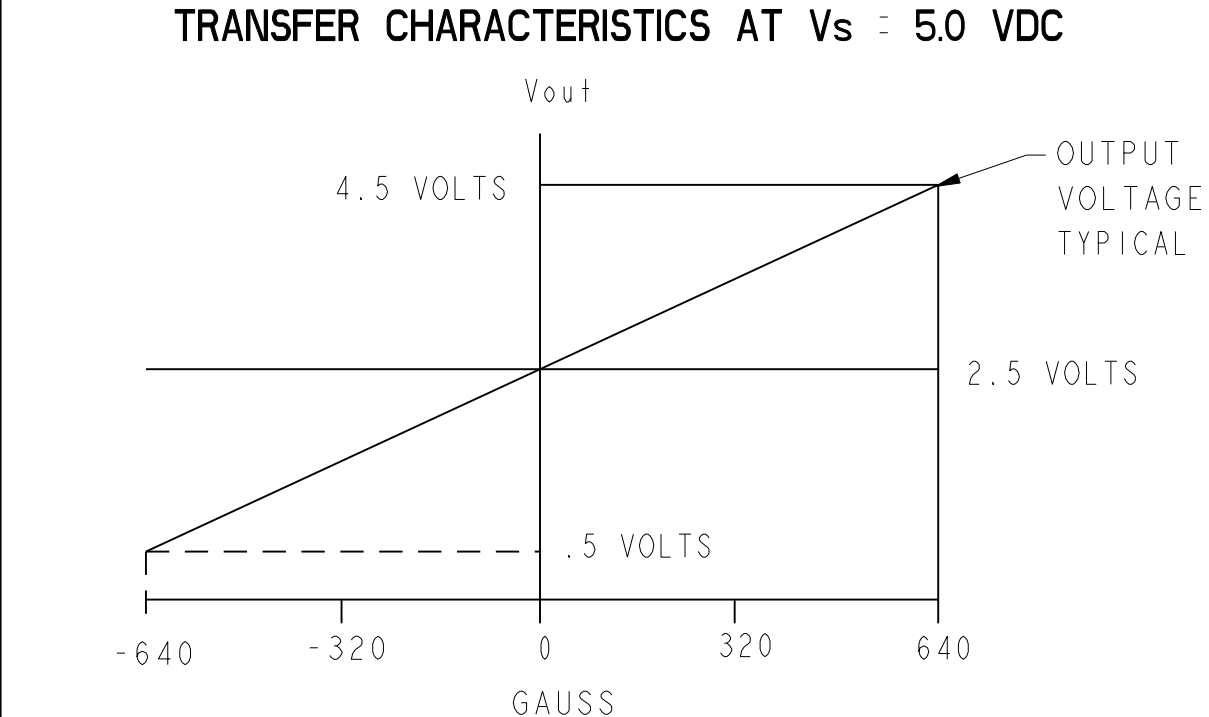
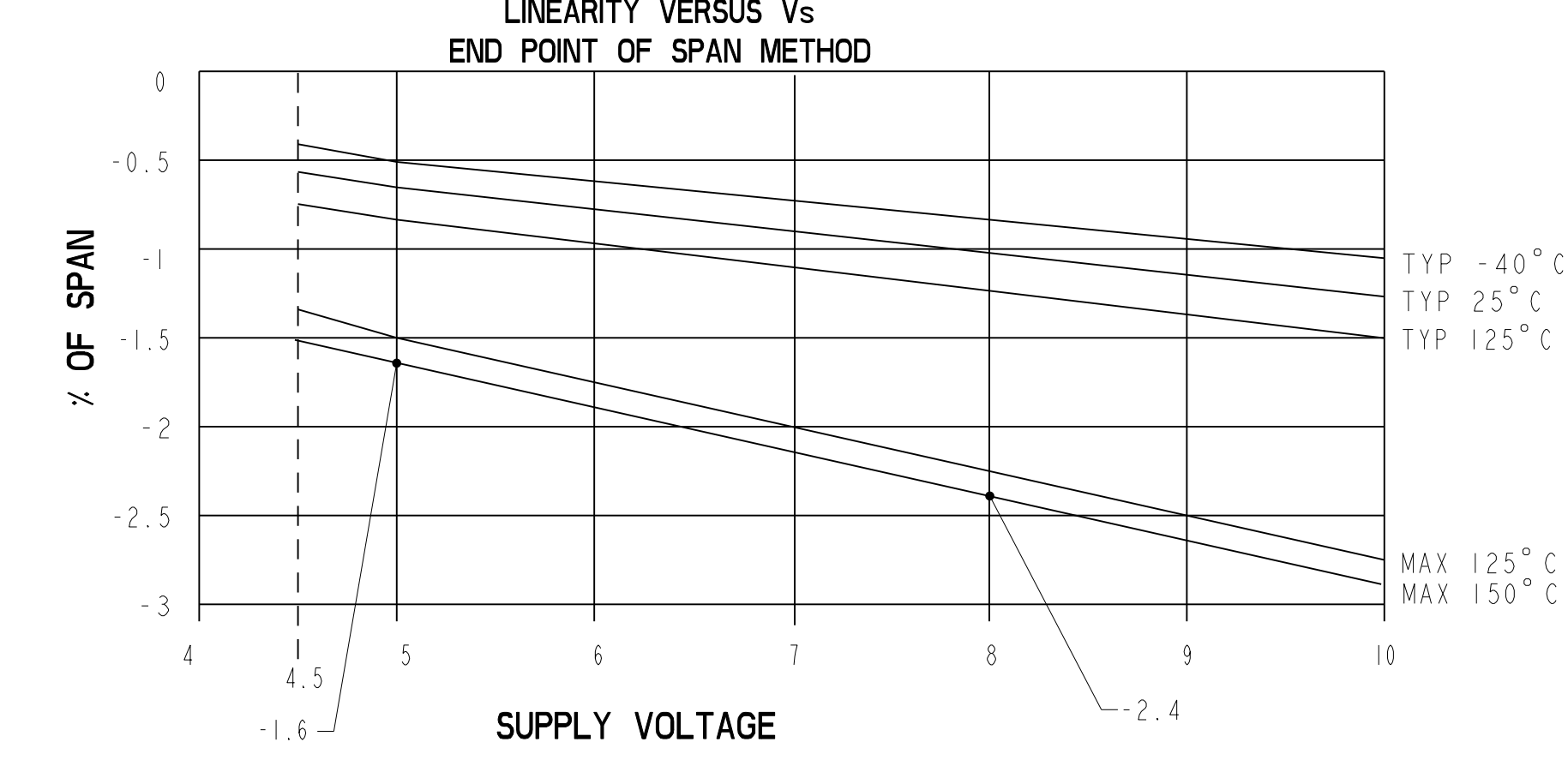
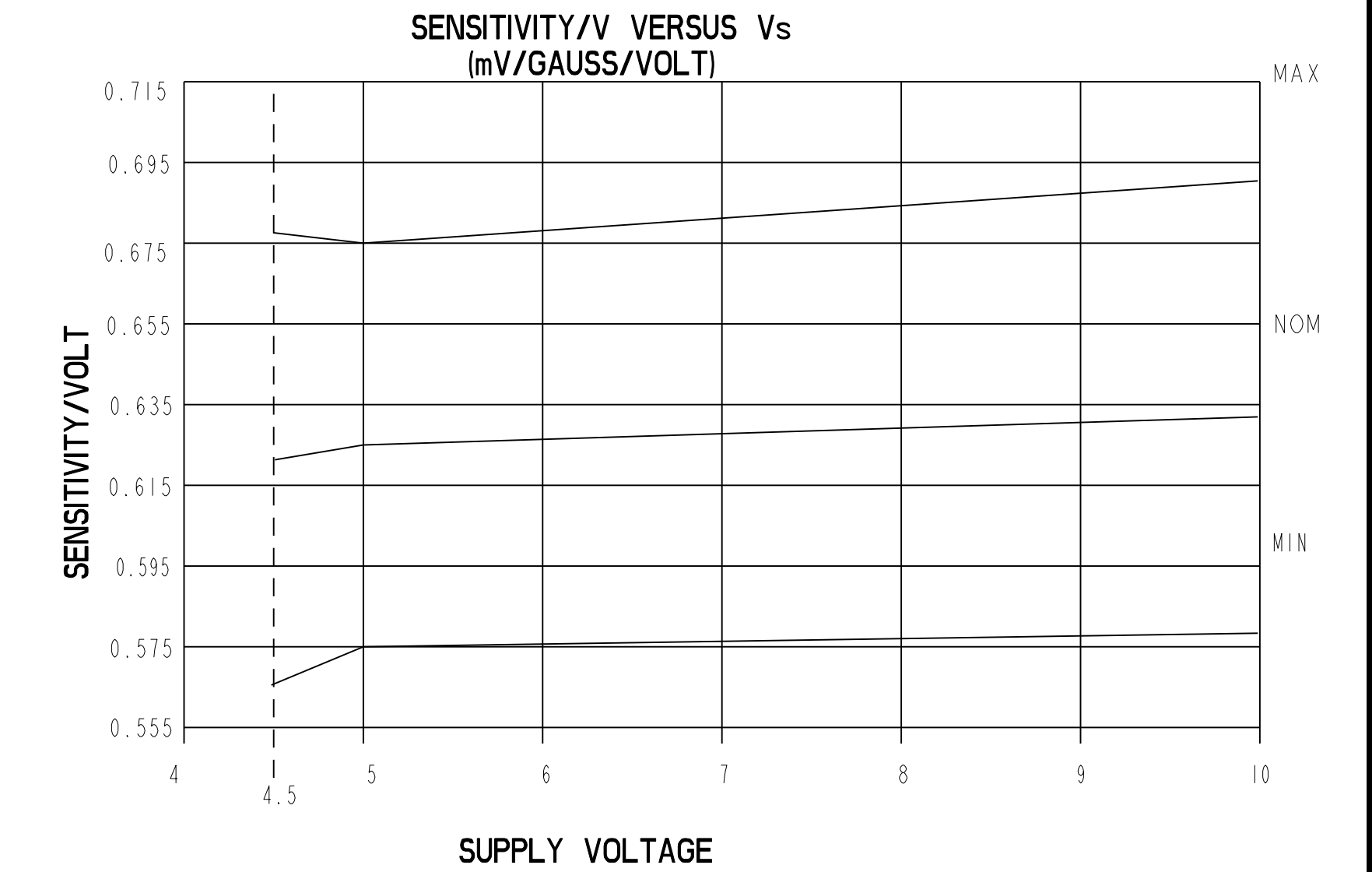
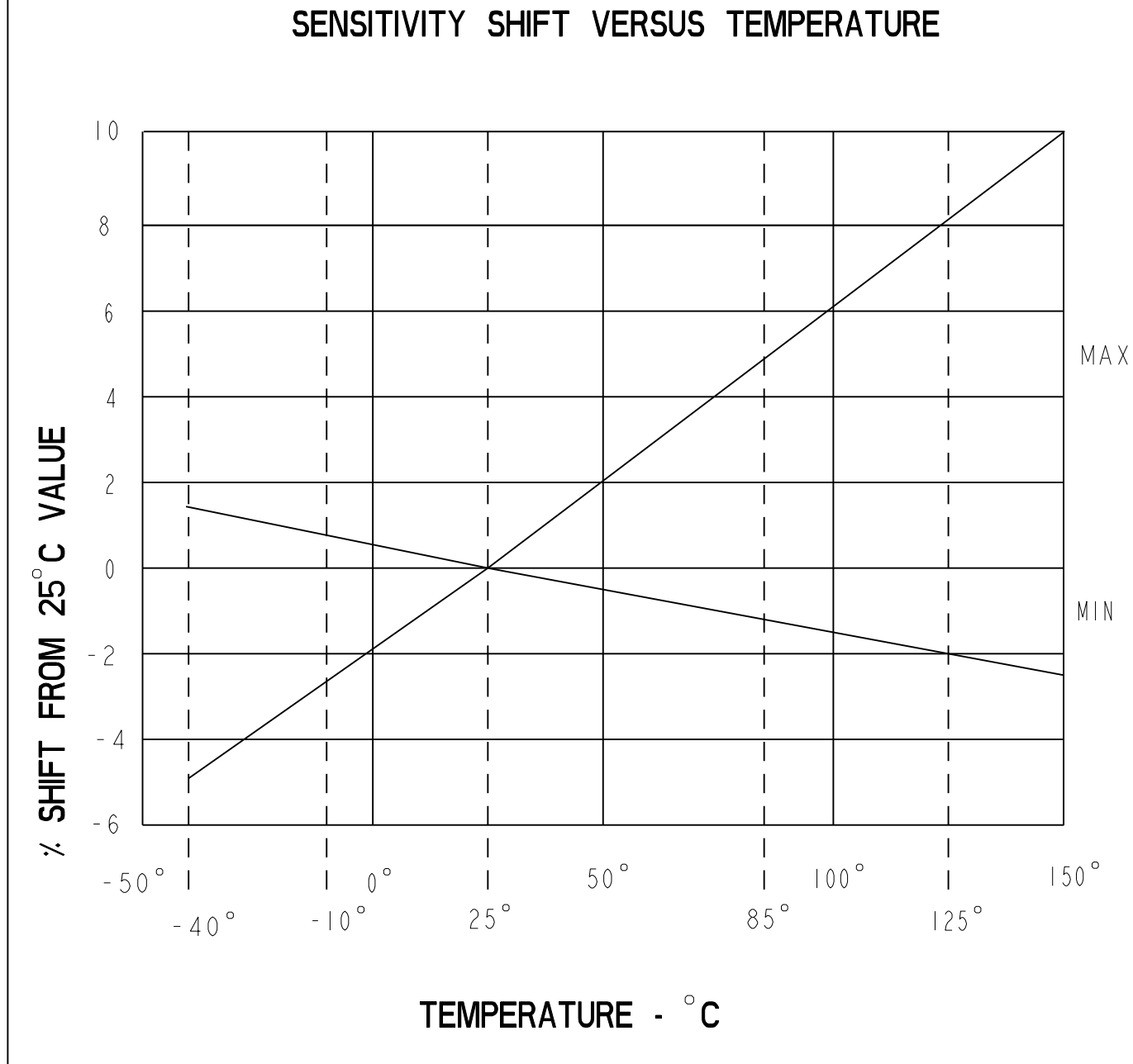
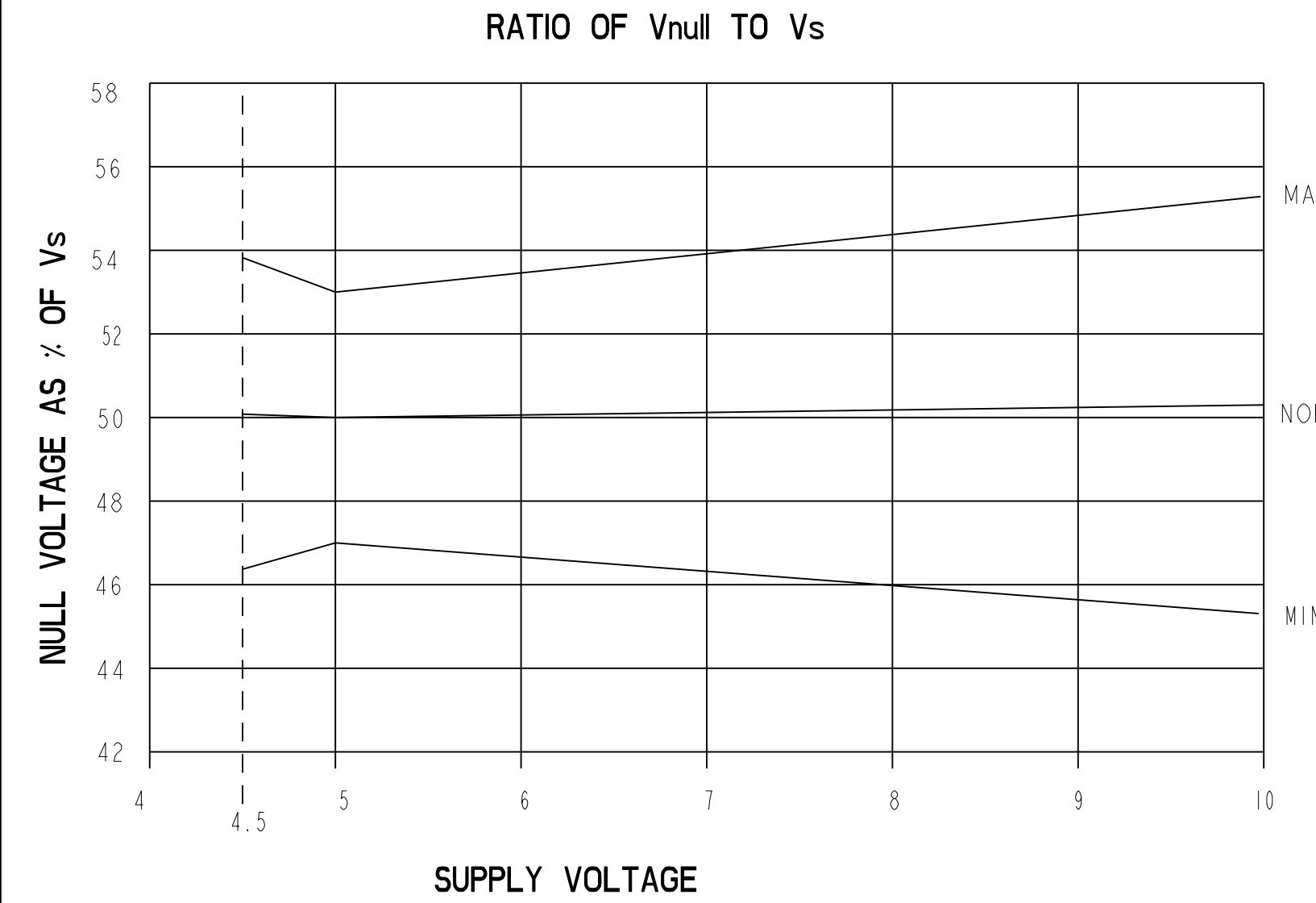
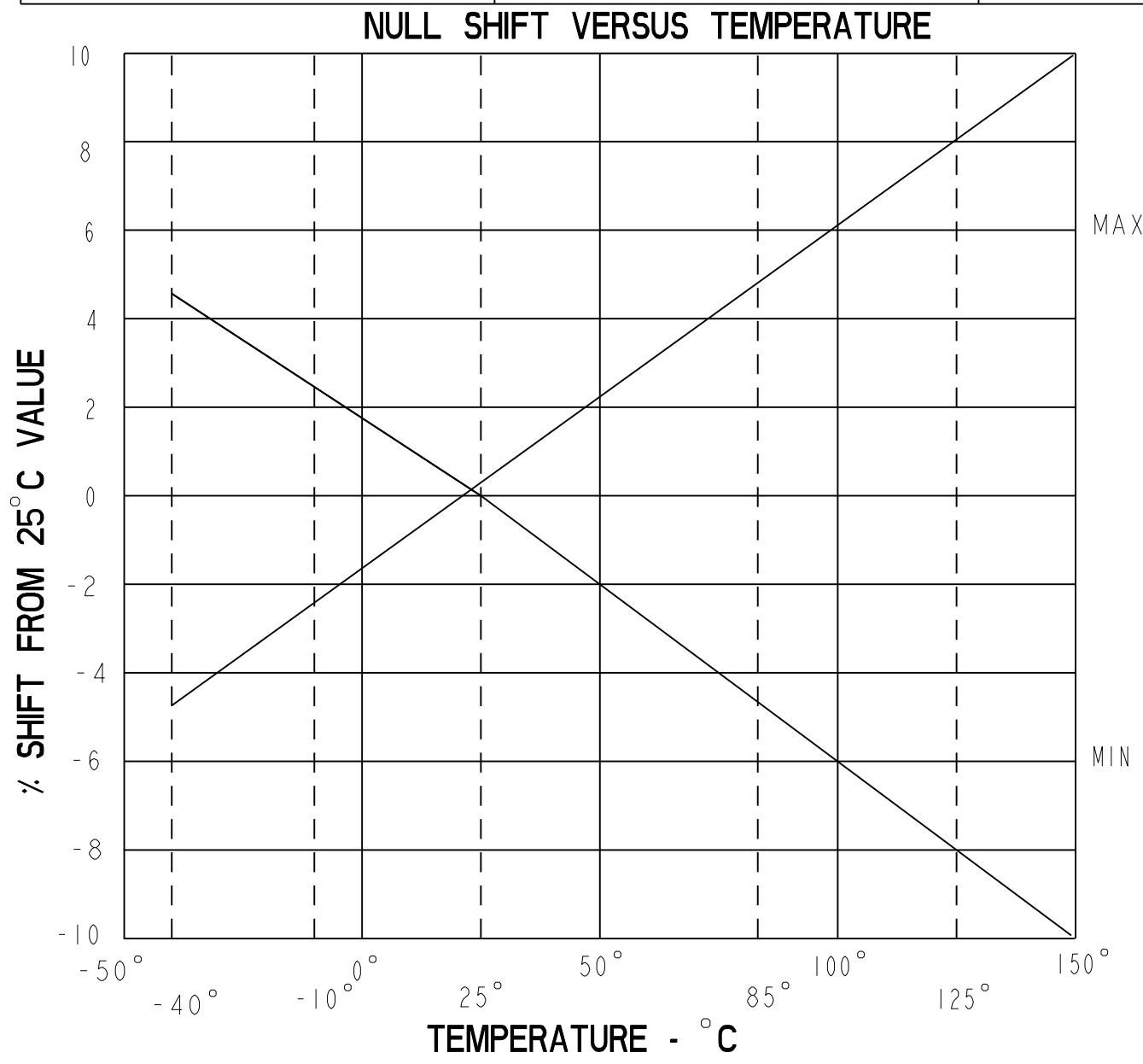

THIS DRAWING COVERS A PROPRIETARY ITEM AND IS THE PROPERTY OF MICRO SWITCH, A DIVISION OF HONEYWELL. THIS DRAWING IS NOT TO BE COPIED OR USED WITHOUT THE APPROVAL OF MICRO SWITCH.

FED. MFG. CODE 91929

**MICRO SWITCH**  
a Honeywell Division

**MINIATURE RATIOMETRIC  
LINEAR HALL EFFECT SENSOR**

SS495 SERIES CHART 1

THIRD ANGLE PROJECTION

SCALE NONE

DO NOT SCALE PRINT

UNLESS OTHERWISE SPECIFIED TOLERANCES ARE

ONE PLACE (.0) +.030

TWO PLACE (.00) +.015

THREE PLACE (.000) +.005

ANGLES +2°

WEIGHT

PTC/CAD 20  
 DRAWN  
 C.S. L. 15 APR 02  
 CHECK  
 SAV 5 APR 02  
 RELEASE NO. PR-24083  
 5 OF 5  
 SS495 SERIES CHART 1  
 14  
 1008535  
 26 OCT 01

## Данный компонент на территории Российской Федерации

### Вы можете приобрести в компании MosChip.

Для оперативного оформления запроса Вам необходимо перейти по данной ссылке:

<http://moschip.ru/get-element>

Вы можете разместить у нас заказ для любого Вашего проекта, будь то серийное производство или разработка единичного прибора.

В нашем ассортименте представлены ведущие мировые производители активных и пассивных электронных компонентов.

Нашей специализацией является поставка электронной компонентной базы двойного назначения, продукции таких производителей как XILINX, Intel (ex.ALTERA), Vicor, Microchip, Texas Instruments, Analog Devices, Mini-Circuits, Amphenol, Glenair.

Сотрудничество с глобальными дистрибьюторами электронных компонентов, предоставляет возможность заказывать и получать с международных складов практически любой перечень компонентов в оптимальные для Вас сроки.

На всех этапах разработки и производства наши партнеры могут получить квалифицированную поддержку опытных инженеров.

Система менеджмента качества компании отвечает требованиям в соответствии с ГОСТ Р ИСО 9001, ГОСТ РВ 0015-002 и ЭС РД 009

### Офис по работе с юридическими лицами:

105318, г.Москва, ул.Щербаковская д.3, офис 1107, 1118, ДЦ «Щербаковский»

Телефон: +7 495 668-12-70 (многоканальный)

Факс: +7 495 668-12-70 (доб.304)

E-mail: [info@moschip.ru](mailto:info@moschip.ru)

Skype отдела продаж:

moschip.ru

moschip.ru\_4

moschip.ru\_6

moschip.ru\_9