

# IB IL IMPULSE-IN ...

**Inline Modular position detection terminal,  
input for magnetostrictive position transducers  
with START/STOP interface**

## AUTOMATION

Data sheet  
6754\_en\_05

© PHOENIX CONTACT - 2010-07-23

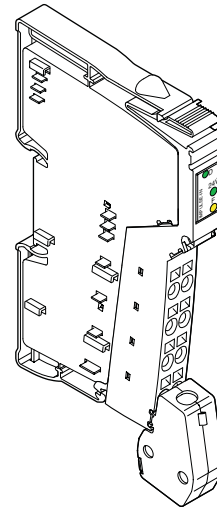

## 1 Description

The terminal is designed for use within an Inline station and is used to evaluate magnetostrictive position transducers with START/STOP interface (digital impulse interface).

The time between a request pulse and its reply pulse is directly proportional to the position of the position encoder on the measurement path. Impulses are transmitted without interference via a differential driver according to RS-422.

The terminal has a channel in the local bus protocol, which is requested and configured via two process data words.

### 1.1 Features

- 24 V DC encoder supply
- Diagnostic and status indicators

### 1.2 Applications

Encoders with START/STOP interface can be connected.



This data sheet is only valid in association with the IL SYS INST UM E user manual.



Make sure you always use the latest documentation.  
This can be downloaded at [www.phoenixcontact.net/catalog](http://www.phoenixcontact.net/catalog).



This data sheet is valid for the products listed on the following page:

## 2 Ordering data

### Inline terminals

| Description   | Type                      | Order No. | Pcs./Pkt. |
|---|---------------------------|-----------|-----------|
| Inline Modular position detection terminal, input for magnetostrictive position transducers with START/STOP interface, without accessories, transmission speed of 500 kbps  | IB IL IMPULSE-IN          | 2819231   | 1         |
| Inline Modular position detection terminal, input for magnetostrictive position transducers with START/STOP interface, complete with accessories (connectors and labeling fields), transmission speed of 500 kbps | IB IL IMPULSE-IN-PAC      | 2861768   | 1         |
| Inline Modular position detection terminal, input for magnetostrictive position transducers with START/STOP interface, without accessories, transmission speed of 2 Mbps  | IB IL IMPULSE-IN-2MBD     | 2819817   | 1         |
| Inline Modular position detection terminal, input for magnetostrictive position transducers with START/STOP interface, complete with accessories (connectors and labeling fields), transmission speed of 2 Mbps   | IB IL IMPULSE-IN-2MBD-PAC | 2819804   | 1         |



The connector listed below is needed for the complete fitting of the IB IL IMPULSE-IN and IB IL IMPULSE-IN-2MBD terminals.

### Accessories

| Description   | Type               | Order No. | Pcs./Pkt. |
|---|--------------------|-----------|-----------|
| Inline shield connector for analog Inline terminals | IB IL SCN-6 SHIELD | 2726353   | 5         |

### Documentation

| Description  | Type             | Order No. | Pcs./Pkt. |
|--|------------------|-----------|-----------|
| "Automation terminals of the Inline product range" user manual | IL SYS INST UM E | 2698737   | 1         |

## 3 Technical data

### General data

|  |   |
|--|---|
| Housing dimensions (width x height x depth)            | 12.2 mm x 136 mm x 72 mm (with connector)                                     |
| Weight (without connectors)                            | 50 g (without connector), 71 g (with connector)                               |
| Operating mode   | Process data mode with 2 words  |
| Ambient temperatures (operation)                       | -25°C ... +55°C   |
| Ambient temperature (storage/transport)                | -25°C ... +85°C   |
| Permissible humidity (operation/storage/transport)     | 10% ... 95% according to DIN EN 61131-2                                       |
| Permissible air pressure (operation/storage/transport) | 70 kPa ... 106 kPa (up to 3000 m above sea level)                             |
| Degree of protection                                   | IP20  |
| Protection class                                       | III, IEC 61140  |
| Connection data for Inline connectors                  |   |
| Connection method                                      | Spring-cage terminals   |
| Conductor cross-section                                | 0.08 mm <sup>2</sup> ... 1.5 mm <sup>2</sup> (solid or stranded), 28 - 16 AWG |

### Interface

|                      |   |
|----------------------|---|
| Local bus            | Inline data jumper  |
| START/STOP interface | Comprising a differential input and a differential output according to RS-422 |

### Transmission speed

|  |          |
|--|----------|
| IB IL IMPULSE-IN, IB IL IMPULSE-IN-PAC           | 500 kbps |
| IB IL IMPULSE-IN-2MBD, IB IL IMPULSE-IN-2MBD-PAC | 2 Mbps   |

| Power consumption              | 500 kbps                                    | 2 Mbps                                      |
|--------------------------------|---|---|
| Communications power $U_L$     | 7.5 V                                       | 7.5 V                                       |
| Current consumption from $U_L$ | 70 mA, maximum                              | 100 mA, maximum                             |
| Power consumption from $U_L$   | 0.525 W                                     | 0.750 W                                     |
| Main supply voltage $U_M$      | 24 V DC, typical                            | 24 V DC, typical                            |
| Current consumption from $U_M$ | 150 mA, typical<br>(with connected encoder) | 150 mA, typical<br>(with connected encoder) |

### Supply of the module electronics and I/O through bus coupler/power terminal

|                   |                           |
|-------------------|---------------------------|
| Connection method | Through potential routing |
|-------------------|---------------------------|

### Magnetostrictive encoder

|                                    |  |
|------------------------------------|--|
| Interface                          | START/STOP interface   |
| Signal voltage level               | Differential signal (signal – inverted signal)<br>$\pm 0.5$ V, minimum; $\pm 6.0$ V, maximum           |
| Common mode range: signal – ground | -10 V ... +13.2 V  |
| Length measuring range             | > 0 mm to 3850 mm  |
| Resolution                         | 5 $\mu$ m  |
| Ultrasonic speed (gradient)        | 2500.00 m/s ... 2999.99 m/s (Firmware 1.22 or later)<br>2750 m/s ... 2898 m/s (Firmware 1.22 or later) |

### Encoder supply

|                           |                                 |
|---------------------------|---------------------------------|
| Voltage range             | 19.2 V ... 30.0 V (from $U_M$ ) |
| Short-circuit protection  | Electronic and thermal          |
| Current carrying capacity | 250 mA, maximum                 |



The status of the encoder supply is indicated by the green 24 V LED. If the internal voltage for the encoder electronics fails or is overloaded, an I/O error is generated. This error is indicated by the diagnostic LED flashing at 2 Hz and transmitted to the higher-level control system.

### Error messages to the higher-level control or computer system

|   |   |
|---|---|
| Failure or overload of the encoder supply | Yes, I/O error message sent to the controller board |
|---|---|

### Limitation of simultaneity, derating

No derating

### Electrical isolation/isolation of the voltage areas

Electrical isolation of the logic level from the I/O area is ensured by the optocoupler.

### Common potentials

The 24 V main voltage, 24 V segment voltage, and GND have the same potential. FE is a separate potential area.

### Separate potentials

| Test distance                                    | Test voltage            |
|--|-------------------------|
| 7.5 V supply (bus logic)/ I/O                    | 500 V AC, 50 Hz, 1 min. |
| 7.5 V supply (bus logic)/functional earth ground | 500 V AC, 50 Hz, 1 min. |
| 24 V supply (I/O)/functional earth ground        | 500 V AC, 50 Hz, 1 min. |

**Conformance with EMC directive 2004/108/EC****Noise immunity test according to EN 61000-6-2**

|                               |                                 |  |   |
|-------------------------------|---------------------------------|--|---|
| Electrostatic discharge (ESD) | EN 61000-4-2<br>(IEC 61000-4-2) | Criterion B:<br>Temporary impairment of operating behavior that is corrected by the device itself. | 6 kV contact discharge<br>8 kV air discharge  |
| Electromagnetic HF field      | EN 61000-4-3<br>(IEC 61000-4-3) | Criterion A:<br>Normal operating behavior within the specified limits.                             | Field strength: 10 V/m  |
| Fast transients (burst)       | EN 61000-4-4<br>(IEC 61000-4-4) | Criterion B:<br>Temporary impairment of operating behavior that is corrected by the device itself. | Signal: 2 kV<br>Supply: 2 kV  |
| Surge current load (surge)    | EN 61000-4-5<br>(IEC 61000-4-5) | Criterion B:<br>Temporary impairment of operating behavior that is corrected by the device itself. | Signal: Up to $\pm 1$ kV asymmetrical<br>Supply: $\pm 0.5$ kV symmetrical,<br>$\pm 0.5$ kV asymmetrical |
| Conducted interference        | EN 61000-4-6<br>(IEC 61000-4-6) | Criterion A:<br>Normal operating behavior within the specified limits.                             | Test voltage 10 V   |

**Noise emission test according to EN 61000-6-4**

|                           |                                      |  |         |
|---------------------------|--------------------------------------|--|---------|
| Noise emission of housing | EN 55011<br>(corresponds to CISPR11) | Class A:<br>Industrial application, without special installation measures. | Class A |
|---------------------------|--------------------------------------|--|---------|

**Approvals**

For the latest approvals, please visit [www.phoenixcontact.net/catalog](http://www.phoenixcontact.net/catalog).

## 4 Basic circuit diagram

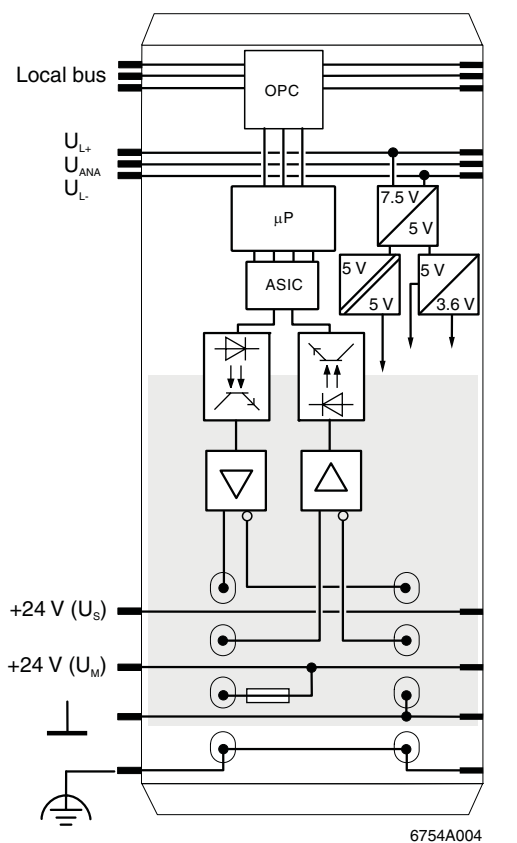

### Key:











|   |  |
|---|--|
|    | Protocol chip (bus logic including voltage conditioning) |
|    | Microprocessor   |
|    | ASIC chip  |
|    | Power supply unit without electrical isolation           |
|    | Power supply unit with electrical isolation              |
|    | Optocoupler  |
|    | RS-422 interface   |
|    | Terminal point   |
|  | Fuse   |
|  | Ground (GND)   |
|  | Functional earth ground                                  |
|  | Electrically isolated area                               |

Figure 1 Internal wiring of the terminal points

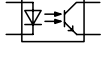
## 5 Local diagnostic/status indicators and terminal point assignment

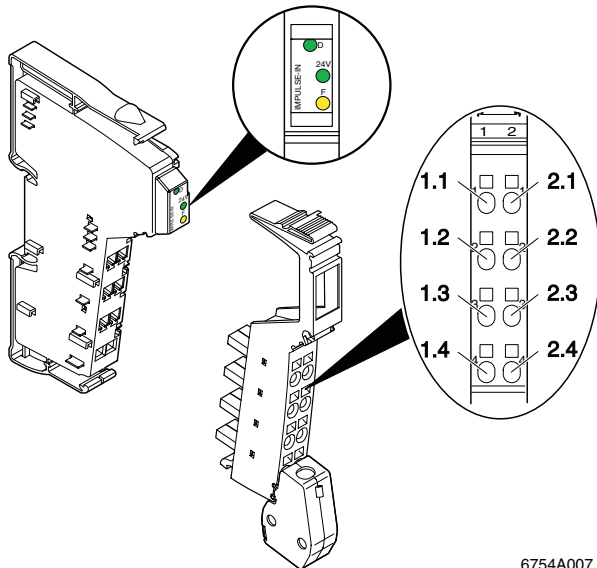

6754A007

Figure 2 Local diagnostic and status indicators

### 5.1 Local diagnostic and status indicators

| Des.       | Color       | Meaning   |
|------------|-------------|---|
| <b>D</b>   | Green LED   | Diagnostics (bus and logic supply)  |
| <b>24V</b> | Green LED   | 24 V encoder supply   |
|            | ON:<br>OFF: | 24 V encoder supply present<br>24 V encoder supply not present or short circuit |
| <b>F</b>   | Yellow LED  | Measurement   |
|            | ON:         | Invalid measurement   |
|            | OFF:        | Valid measurement   |

### 5.2 Function identification

Orange

2 Mbps: White stripe in the vicinity of the D LED

### 5.3 Terminal point assignment

| Terminal point | Signal      | Assignment                       |
|----------------|-------------|----------------------------------|
| 1.1            | INIT        | INIT output                      |
| 2.1            | /INIT       | Inverted INIT output             |
| 1.2            | START-STOP  | START/STOP input                 |
| 2.2            | /START-STOP | Inverted START/STOP input        |
| 1.3            | 24 V        | Encoder supply (250 mA, maximum) |
| 2.3            | GND         | Ground                           |
| 1.4, 2.4       | Shield      | Encoder cable shield             |

## 6 Connection example

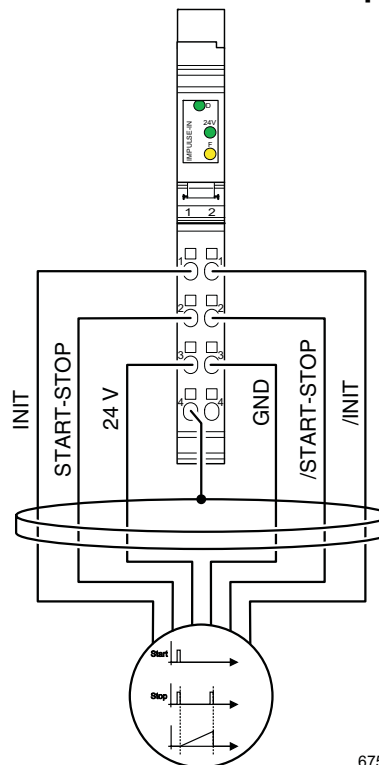

6754C005

Figure 3 Typical connection

Legend:



Impulse encoder

## 7 Connection notes



Encoders should always be connected using **shielded** twisted pair cables. Unshielded cables may lead to erroneous results in environments with heavy noise. On the terminal side, the shield is capacitively connected to functional earth ground (FE) via the shield connector. On the encoder side, the shield must be connected with the grounded encoder housing.

If the encoder does not have a shield connection, the shield can also be directly connected in the control cabinet to functional earth ground via an additional shield connection clamp.



For additional information about shielding and connecting the shielded cables, please refer to the IL SYS INST UM E user manual.



Please also observe the manufacturer's installation instructions for the position encoder.

## 8 Functions

The terminal is used to evaluate magnetostrictive position transducers with START/STOP interface.

These systems operate absolutely in the measuring range from > 0 mm to 3850 mm with a resolution of 5 µm. An external power supply unit for the position encoder is not required, as power is provided by the terminal.

The data width in the bus system is 32 bits. The IN register has seven bits for status indicators and messages and 25 bits for actual position values (see "IN process data" on page 8).

The OUT register has seven bits for control codes, three bits for the encoder length, and 20 bits for the ultrasonic speed (see "OUT process data" on page 9).

### 8.1 Error messages

The terminal has monitoring mechanisms, which trigger in the event of the following errors and generate an I/O error message:

- I/O error (monitoring of the position encoder power supply)  
If the encoder supply fails or is overloaded, an I/O error is triggered and a corresponding message code is generated.

### 8.2 Actual value acquisition

On each firmware cycle (measuring cycle) the position of the position sensor is acquired. The firmware cycle depends on the set encoder length.

For actual value acquisition, an impulse (START) is sent to a position transducer, which leads to a reply impulse (STOP) through reflection at the magnetic field of the position sensor. The terminal measures the time that elapses until the reply impulse is returned.

In the terminal, the return path is calculated by multiplying with the propagation rate of the impulse in the position transducer, and stored in the process data.

## 9 Programming and configuration data

### 9.1 Local bus (INTERBUS)

|                         |   |
|-------------------------|---|
| ID code                 | 5F <sub>hex</sub> (95 <sub>dec</sub> )  |
| Length code             | 02 <sub>hex</sub> (133 <sub>dec</sub> ) |
| Process data channel    | 32 bits                                 |
| Input address area      | 2 words                                 |
| Output address area     | 2 words                                 |
| Parameter channel (PCP) | 0 bytes                                 |
| Register length (bus)   | 2 words                                 |

### 9.2 Other bus systems



For the configuration data of other bus systems, please refer to the corresponding electronic device data sheet (e.g., GSD, EDS).

## 10 Process data

### 10.1 IN process data

|                 |            |                                      |    |    |    |    |    |   |   |                                       |   |   |   |   |   |   |   |
|-----------------|------------|--------------------------------------|----|----|----|----|----|---|---|---------------------------------------|---|---|---|---|---|---|---|
| (Word.bit) view | Word       | Word 0                               |    |    |    |    |    |   |   |                                       |   |   |   |   |   |   |   |
|                 | Bit        | 15                                   | 14 | 13 | 12 | 11 | 10 | 9 | 8 | 7                                     | 6 | 5 | 4 | 3 | 2 | 1 | 0 |
| (Byte.bit) view | Byte       | Byte 0                               |    |    |    |    |    |   |   | Byte 1                                |   |   |   |   |   |   |   |
|                 | Bit        | 7                                    | 6  | 5  | 4  | 3  | 2  | 1 | 0 | 7                                     | 6 | 5 | 4 | 3 | 2 | 1 | 0 |
| IN[0]           | Assignment | Status                               |    |    |    |    |    |   |   | Actual position value (bits 16 to 24) |   |   |   |   |   |   |   |
| (Word.bit) view | Word       | Word 1                               |    |    |    |    |    |   |   |                                       |   |   |   |   |   |   |   |
|                 | Bit        | 15                                   | 14 | 13 | 12 | 11 | 10 | 9 | 8 | 7                                     | 6 | 5 | 4 | 3 | 2 | 1 | 0 |
| (Byte.bit) view | Byte       | Byte 2                               |    |    |    |    |    |   |   | Byte 3                                |   |   |   |   |   |   |   |
|                 | Bit        | 7                                    | 6  | 5  | 4  | 3  | 2  | 1 | 0 | 7                                     | 6 | 5 | 4 | 3 | 2 | 1 | 0 |
| IN[0]           | Assignment | Actual position value (bits 0 to 15) |    |    |    |    |    |   |   |                                       |   |   |   |   |   |   |   |

#### Status

| IN[0]<br>Bit 15 to Bit 9 |     | Description   | Position actual value |
|--------------------------|-----|---|-----------------------|
| bin                      | hex |   |                       |
| 000 0000                 | 00  | <b>Offline:</b> The module is in the idle state. The configuration data is checked by sending the "Read position" command. If this is valid, the module changes to the "operation" state.   | Invalid               |
| 000 0001                 | 01  | <b>Operation:</b> If bit 9 = TRUE, the measured value (the position) of the position sensor is valid, i.e., the configuration data is valid and valid position values have been read by the encoder.  | Valid                 |
| X1X XXX0                 | XX  | Acknowledgment for the "Acknowledge error" control code. Once the control code at "Read position" has been modified, the terminal changes to the "Read position" state (if the error has been removed) or returns to one of the error states. | Invalid               |
| 100 0010                 | 42  | <b>Error:</b> Encoder supply not present or short circuit.  | Invalid               |
| 100 0100                 | 44  | <b>Error:</b> Encoder error<br>After sending the START impulse, no STOP impulse was received by the encoder within the maximum measuring time (dependent on the configured encoder length, see <b>OUT[0] Bit4 ... Bit6</b> ).                 | Invalid               |
| 100 1000                 | 48  | <b>Error:</b> Invalid configuration data<br>The configuration data is outside the limit values.   | Invalid               |
| 101 0000                 | 50  | <b>Error:</b> Invalid control code<br>An unknown or invalid control code was transferred.   | Invalid               |
| 101 1000                 | 58  | <b>Error:</b> Cycle time too short<br>No reliable position measurement is possible because the INTERBUS cycle time is too short.  | Invalid               |

#### Position actual value

Absolute actual value of the current position with a resolution of 5 µm.

Example:

$$12.05 \text{ cm} = 120500$$

$$120500 \text{ µm} / 5 \text{ µm} = 24100 = 5E24_{\text{hex}}$$



## 10.2 OUT process data

The OUT process data is evaluated as soon as the control code is mirrored in the IN process data.



The OUT process data specifies the output values in each bus cycle. The configuration data must be complete. Without complete configuration data, the terminal will not change to the ready state.

|                 |            |              |    |    |    |    |    |   |   |        |   |                |   |   |   |                                  |   |  |  |
|-----------------|------------|--------------|----|----|----|----|----|---|---|--------|---|----------------|---|---|---|----------------------------------|---|--|--|
| (Word.bit) view | Word       | Word 0       |    |    |    |    |    |   |   |        |   |                |   |   |   |                                  |   |  |  |
|                 | Bit        | 15           | 14 | 13 | 12 | 11 | 10 | 9 | 8 | 7      | 6 | 5              | 4 | 3 | 2 | 1                                | 0 |  |  |
| (Byte.bit) view | Byte       | Byte 0       |    |    |    |    |    |   |   | Byte 1 |   |                |   |   |   |                                  |   |  |  |
|                 | Bit        | 7            | 6  | 5  | 4  | 3  | 2  | 1 | 0 | 7      | 6 | 5              | 4 | 3 | 2 | 1                                | 0 |  |  |
| OUT[0]          | Assignment | Control code |    |    |    |    |    |   |   | 0      | 0 | Encoder length |   |   |   | Ultrasonic speed (bits 19 to 16) |   |  |  |

|                 |            |                                 |    |    |    |    |    |   |   |        |   |   |   |   |   |   |   |
|-----------------|------------|---------------------------------|----|----|----|----|----|---|---|--------|---|---|---|---|---|---|---|
| (Word.bit) view | Word       | Word 0                          |    |    |    |    |    |   |   |        |   |   |   |   |   |   |   |
|                 | Bit        | 15                              | 14 | 13 | 12 | 11 | 10 | 9 | 8 | 7      | 6 | 5 | 4 | 3 | 2 | 1 | 0 |
| (Byte.bit) view | Byte       | Byte 0                          |    |    |    |    |    |   |   | Byte 1 |   |   |   |   |   |   |   |
|                 | Bit        | 7                               | 6  | 5  | 4  | 3  | 2  | 1 | 0 | 7      | 6 | 5 | 4 | 3 | 2 | 1 | 0 |
| OUT[1]          | Assignment | Ultrasonic speed (bits 15 to 0) |    |    |    |    |    |   |   |        |   |   |   |   |   |   |   |



**NOTE: Misinterpretation of values when data is not consistent**  
Ensure data consistency of two words to prevent the possibility of misinterpreting the values.

### Control code

The control code is used to select terminal operating states. When the terminal has detected the control code, it is mirrored in the status (see Section "Status").

| OUT[0]<br>Bits 15 to 9 |     | Control code   |
|------------------------|-----|--|
| bin                    | hex |  |
| 000 0000               | 00  | No action (ignored)  |
| 000 0001               | 01  | <b>Read position:</b> On the transition from the "Offline" state to the "Operation" state, the configuration data is checked and the terminal is configured. When position acquisition is successful, the module changes to the "Operation" state. |
| 000 0010               | 02  | <b>Switch "Offline":</b> The terminal changes from the "Operation" state to the "Offline" state; the configuration is reset.   |
| 010 0001               | 21  | <b>Acknowledge error:</b> On the transition from the "Error" state to the "Operation" state, the configuration is maintained.  |

The terminal supports various error codes, which are generally reported as encoder errors.

The causes are:

- No echo  
(Encoder not connected correctly; position encoder faulty; position encoder too far from position transducer; position encoder has exited the valid range of the position transducer)
- Incorrect echo  
(Position transducer itself is strongly accelerated; strongly bundled magnetic field affecting the position transducer)

In the event of an encoder error that is to be removed or ignored, the encoder error can be acknowledged by the control code 010 0001<sub>bin</sub>. After an acknowledgment, normal operation must be set (control code 000 0001<sub>bin</sub>).

If the error remains after the acknowledgment has been removed, a new error is indicated (status 1xx xxxx<sub>bin</sub>).

### "0" (unused):

These bits should **not** be set (unknown configuration).

### Encoder length

In order to optimize the time required for the acquisition of a position, the terminal should know the encoder length (position transducer length). This is divided into increments of 0.5 m and **rounded up** if required, i.e., if the encoder length is between two values, the next highest length should always be specified.

| OUT[0] Bit 4 to Bit 6 |     | Encoder length |
|-----------------------|-----|----------------|
| bin                   | hex |                |
| 0000                  | 0   | 0.5 m          |
| 0001                  | 1   | 1.0 m          |
| 0010                  | 2   | 1.5 m          |
| 0011                  | 3   | 2.0 m          |
| 0100                  | 4   | 2.5 m          |
| 0101                  | 5   | 3.0 m          |
| 0110                  | 6   | 3.5 m          |
| 0111                  | 7   | 4.0 m          |

| Encoder length | Limit values |     |      |
|----------------|--------------|-----|------|
|                | dec          | hex | bin  |
| Minimum        | 0.5 m        | 0   | 0000 |
| Maximum        | 4.0 m        | 7   | 0111 |

If the values of the encoder length are outside the limit value range, the terminal outputs the message code "Invalid configuration data" (1000100<sub>bin</sub>).



**NOTE: Inaccurate measurement owing to incorrect encoder length**

If the specified encoder length (position transducer length) is too short, measurements will be inaccurate.

### Ultrasonic speed

During configuration, the ultrasonic speed of the pulse in the position transducer (indicated on the rating plate of the position transducer) must be sent to the terminal, so that the terminal can correctly calculate the position of the position transducer.

| Ultrasonic speed                | Limit values |       |                          |
|---------------------------------|--------------|-------|--------------------------|
|                                 | dec [m/s]    | hex   | bin                      |
| <b>Firmware 2.01 or later</b>   |              |       |                          |
| Minimum                         | 2500.00      | 50000 | 0101 0000 0000 0000 0000 |
| Maximum                         | 2999.99      | 99999 | 1001 1001 1001 1001 1001 |
| <b>Firmware 1.21 or earlier</b> |              |       |                          |
| Minimum                         | 2750         | 75000 | 0111 0101 0000 0000 0000 |
| Maximum                         | 2898         | 89800 | 1000 1001 1000 0000 0000 |

If the values of the ultrasonic speed are outside the limit value range, the terminal outputs the message code "Invalid configuration data" (1000100<sub>bin</sub>).

Since the terminal internally adds an offset of 2000 m/s, the value specified on the rating plate is sent to the terminal as a hexadecimal value without the highest integer position.

Example:

Ultrasonic speed in the position transducer  
= 2835.45 m/s

Value sent to terminal:  
835.45 = 83545<sub>hex</sub>

### 10.3 "Read Firmware Version and Sub ID" special function

The terminal has a special function, which can be used to read its firmware version and sub ID. The sub ID can be used to distinguish between other Inline terminals with the same ID code. The terminal has the sub ID "F<sub>hex</sub>".



The firmware version and sub ID can only be requested in the "Offline" state. During operation, this control command generates an error message.

| Word | OUT[0] |    |    |    |    |    |   |   |   |   |   |   |   |   |   |   |
|------|--------|----|----|----|----|----|---|---|---|---|---|---|---|---|---|---|
| Bit  | 15     | 14 | 13 | 12 | 11 | 10 | 9 | 8 | 7 | 6 | 5 | 4 | 3 | 2 | 1 | 0 |
| Bin  | 0      | 0  | 1  | 1  | 1  | 1  | 0 | 0 | 0 | 0 | 0 | 0 | 0 | 0 | 0 | 0 |
| Hex  | 3      |    |    |    | C  |    |   |   | 0 |   |   |   | 0 |   |   |   |
| Word | OUT[1] |    |    |    |    |    |   |   |   |   |   |   |   |   |   |   |
| Bit  | 15     | 14 | 13 | 12 | 11 | 10 | 9 | 8 | 7 | 6 | 5 | 4 | 3 | 2 | 1 | 0 |
| Bin  | 0      | 0  | 0  | 0  | 0  | 0  | 0 | 0 | 0 | 0 | 0 | 0 | 0 | 0 | 0 | 0 |
| Hex  | 0      |    |    |    | 0  |    |   |   | 0 |   |   |   | 0 |   |   |   |

#### Status with mirrored control code

| Word | IN[0] |    |    |    |    |    |   |   |   |   |   |   |   |   |   |   |
|------|-------|----|----|----|----|----|---|---|---|---|---|---|---|---|---|---|
| Bit  | 15    | 14 | 13 | 12 | 11 | 10 | 9 | 8 | 7 | 6 | 5 | 4 | 3 | 2 | 1 | 0 |
| Bin  | 0     | 0  | 1  | 1  | 1  | 1  | 0 | 0 | 0 | 0 | 0 | 0 | 0 | 0 | 0 | 0 |
| Hex  | 3     |    |    |    | C  |    |   |   | 0 |   |   |   | 0 |   |   |   |

#### Firmware version (e.g., 100) and sub ID (F)

| Word | IN[1] |    |    |    |    |    |   |   |   |   |   |   |   |   |   |   |
|------|-------|----|----|----|----|----|---|---|---|---|---|---|---|---|---|---|
| Bit  | 15    | 14 | 13 | 12 | 11 | 10 | 9 | 8 | 7 | 6 | 5 | 4 | 3 | 2 | 1 | 0 |
| Bin  | 0     | 0  | 0  | 1  | 0  | 0  | 0 | 0 | 0 | 0 | 0 | 0 | 1 | 1 | 1 | 1 |
| Hex  | 1     |    |    |    | 0  |    |   |   | 0 |   |   |   | F |   |   |   |

## Данный компонент на территории Российской Федерации

### Вы можете приобрести в компании MosChip.

Для оперативного оформления запроса Вам необходимо перейти по данной ссылке:

<http://moschip.ru/get-element>

Вы можете разместить у нас заказ для любого Вашего проекта, будь то серийное производство или разработка единичного прибора.

В нашем ассортименте представлены ведущие мировые производители активных и пассивных электронных компонентов.

Нашей специализацией является поставка электронной компонентной базы двойного назначения, продукции таких производителей как XILINX, Intel (ex.ALTERA), Vicor, Microchip, Texas Instruments, Analog Devices, Mini-Circuits, Amphenol, Glenair.

Сотрудничество с глобальными дистрибьюторами электронных компонентов, предоставляет возможность заказывать и получать с международных складов практически любой перечень компонентов в оптимальные для Вас сроки.

На всех этапах разработки и производства наши партнеры могут получить квалифицированную поддержку опытных инженеров.

Система менеджмента качества компании отвечает требованиям в соответствии с ГОСТ Р ИСО 9001, ГОСТ РВ 0015-002 и ЭС РД 009

### Офис по работе с юридическими лицами:

105318, г.Москва, ул.Щербаковская д.3, офис 1107, 1118, ДЦ «Щербаковский»

Телефон: +7 495 668-12-70 (многоканальный)

Факс: +7 495 668-12-70 (доб.304)

E-mail: [info@moschip.ru](mailto:info@moschip.ru)

Skype отдела продаж:

moschip.ru

moschip.ru\_4

moschip.ru\_6

moschip.ru\_9