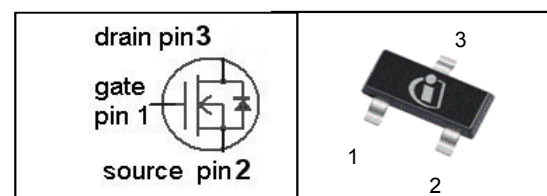

OptiMOS™ Small-Signal-Transistor
Features

- N-channel
- Enhancement mode
- Logic level
- Avalanche rated
- fast switching
- Pb-free lead-plating; RoHS compliant
- Halogen-free according to IEC61249-2-21

Product Summary

V_{DS}		60	V
$R_{DS(on),max}$	$V_{GS}=10\text{ V}$	3	Ω
	$V_{GS}=4.5\text{ V}$	4	
I_D		0.3	A

PG-SOT23

Type	Package	Tape and Reel Information	Marking	HalogenFree	Packing
2N7002	PG-SOT-23	H6327: 3000 pcs/reel	72s	Yes	Non Dry

Parameter	Symbol	Conditions	Value	Unit
Continuous drain current	I_D	$T_A=25\text{ °C}$	0.30	A
		$T_A=70\text{ °C}$	0.24	
Pulsed drain current	$I_{D,pulse}$	$T_A=25\text{ °C}$	1.2	
Avalanche energy, single pulse	E_{AS}	$I_D=0.3\text{ A}, R_{GS}=25\ \Omega$	1.3	mJ
Reverse diode dv/dt	dv/dt	$I_D=0.3\text{ A}, V_{DS}=48\text{ V},$ $di/dt=200\text{ A}/\mu\text{s},$ $T_{j,max}=150\text{ °C}$	6	kV/ μs
Gate source voltage	V_{GS}		± 20	V
ESD class		JESD22-A114 (HBM)	class 0 (<250V)	
Power dissipation	$P_{tot}^{(2)}$	$T_A=25\text{ °C}$	0.5	W
Operating and storage temperature	T_j, T_{stg}		-55 ... 150	$^{\circ}\text{C}$
IEC climatic category; DIN IEC 68-1			55/150/56	

⁽¹⁾ J-STD20 and JESD22

Parameter	Symbol	Conditions	Values			Unit
			min.	typ.	max.	

Thermal characteristics

Thermal resistance, junction - minimal footprint ⁽²⁾	R_{thJA}		-	-	250	K/W
---	------------	--	---	---	-----	-----

Electrical characteristics, at $T_j=25\text{ }^\circ\text{C}$, unless otherwise specified
Static characteristics

Drain-source breakdown voltage	$V_{(BR)DSS}$	$V_{GS}=0\text{ V}, I_D=250\text{ }\mu\text{A}$	60	-	-	V
Gate threshold voltage	$V_{GS(th)}$	$V_{DS}=V_{GS}, I_D=250\text{ }\mu\text{A}$	1.5	2.1	2.5	
Drain-source leakage current	$I_{D(off)}$	$V_{DS}=60\text{ V},$ $V_{GS}=0\text{ V}, T_j=25\text{ }^\circ\text{C}$	-	-	0.1	μA
		$V_{DS}=60\text{ V},$ $V_{GS}=0\text{ V}, T_j=150\text{ }^\circ\text{C}$	-	-	5	
Gate-source leakage current	I_{GSS}	$V_{GS}=20\text{ V}, V_{DS}=0\text{ V}$	-	1	10	nA
Drain-source on-state resistance	$R_{DS(on)}$	$V_{GS}=4.5\text{ V}, I_D=0.25\text{ A}$	-	2.0	4	Ω
		$V_{GS}=10\text{ V}, I_D=0.5\text{ A}$	-	1.6	3	
Transconductance	g_{fs}	$ V_{DS} >2 I_D R_{DS(on)max},$ $I_D=0.24\text{ A}$	0.2	0.36	-	S

⁽²⁾ Performed on a 40x40mm² FR4 PCB with both sided Cu sense-force traces, each 1mm wide, 70 μm thick and 20mm long.

Parameter	Symbol	Conditions	Values			Unit
			min.	typ.	max.	

Dynamic characteristics

Input capacitance	C_{iss}	$V_{GS}=0\text{ V}, V_{DS}=25\text{ V},$ $f=1\text{ MHz}$	-	13	20	pF
Output capacitance	C_{oss}		-	4.1	6	
Reverse transfer capacitance	C_{rss}		-	2.0	3	
Turn-on delay time	$t_{d(on)}$	$V_{DD}=30\text{ V}, V_{GS}=10\text{ V},$ $I_D=0.5\text{ A}, R_G=6\ \Omega$	-	3.0	4.5	ns
Rise time	t_r		-	3.3	5	
Turn-off delay time	$t_{d(off)}$		-	5.5	9	
Fall time	t_f		-	3.1	5	

Gate Charge Characteristics

Gate to source charge	Q_{gs}	$V_{DD}=48\text{ V}, I_D=0.5\text{ A},$ $V_{GS}=0\text{ to }10\text{ V}$	-	0.05	0.1	nC
Gate to drain charge	Q_{gd}		-	0.2	0.4	
Gate charge total	Q_g		-	0.4	0.6	
Gate plateau voltage	$V_{plateau}$		-	4.0	-	V

Reverse Diode

Diode continuous forward current	I_S	$T_A=25\text{ }^\circ\text{C}$	-	-	0.3	A
Diode pulse current	$I_{S,pulse}$		-	-	1.2	
Diode forward voltage	V_{SD}	$V_{GS}=0\text{ V}, I_F=0.5\text{ A},$ $T_J=25\text{ }^\circ\text{C}$	-	0.96	1.2	V
Reverse recovery time	t_{rr}	$V_R=30\text{ V}, I_F=0.5\text{ A},$ $di_F/dt=100\text{ A}/\mu\text{s}$	-	8.5	13	ns
Reverse recovery charge	Q_{rr}		-	2.4	4	nC

1 Power dissipation

$P_{tot}=f(T_A)$

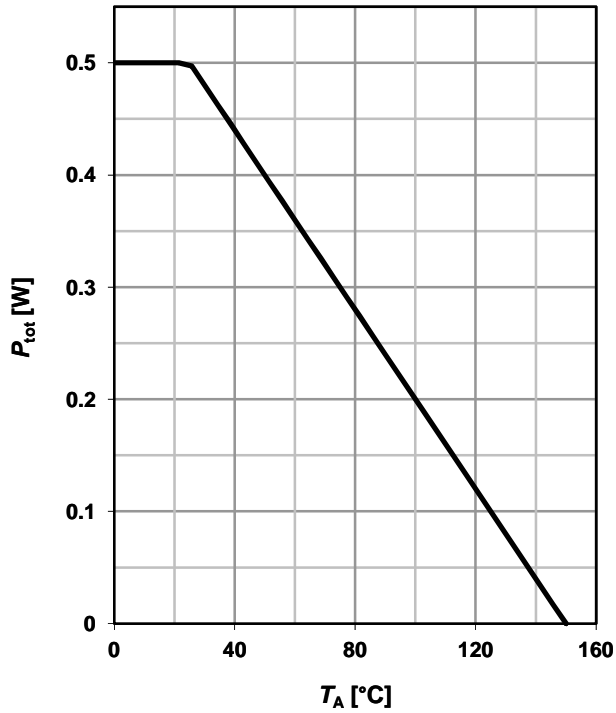

2 Drain current

$I_D=f(T_A); V_{GS} \geq 10\text{ V}$

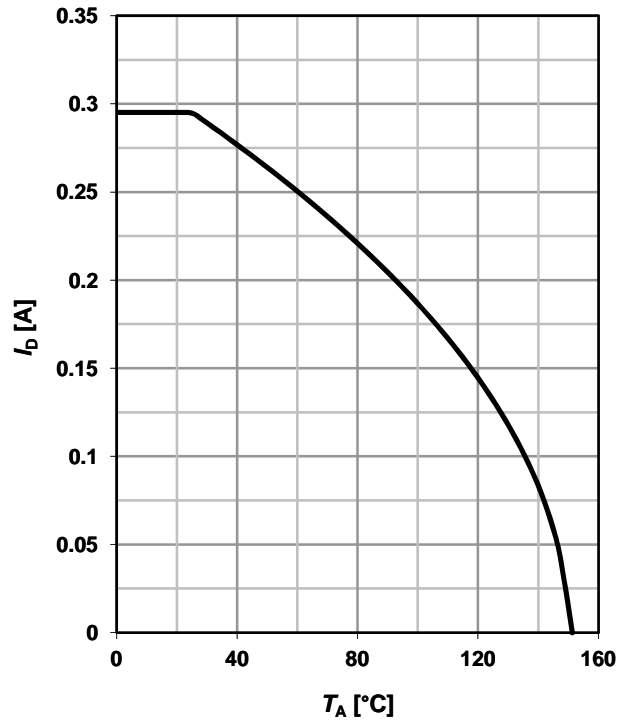

3 Safe operating area

$I_D=f(V_{DS}); T_A=25\text{ °C}; D=0$

parameter: t_p

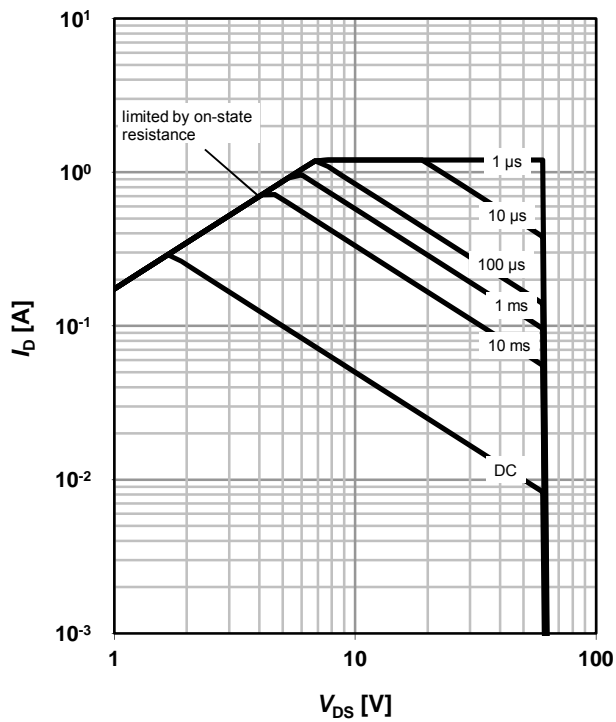

4 Max. transient thermal impedance

$Z_{thJA}=f(t_p)$

parameter: $D=t_p/T$

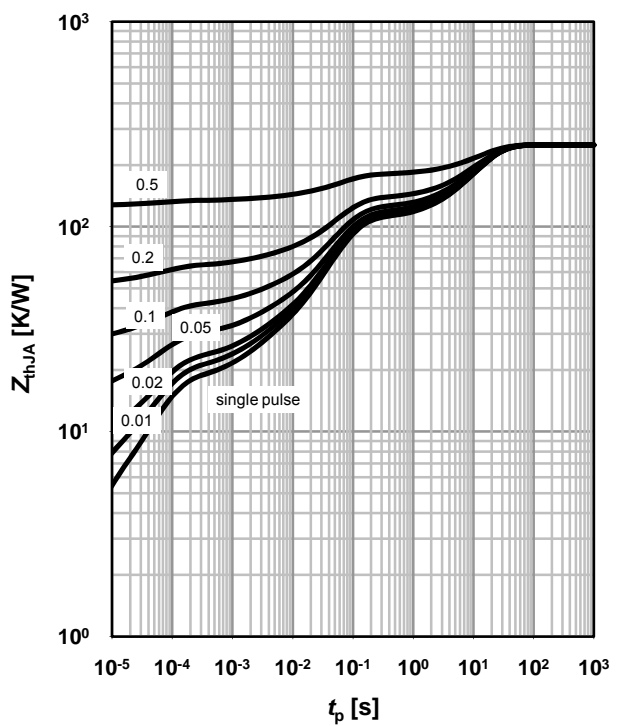

5 Typ. output characteristics

$I_D = f(V_{DS}); T_j = 25\text{ }^\circ\text{C}$

parameter: V_{GS}

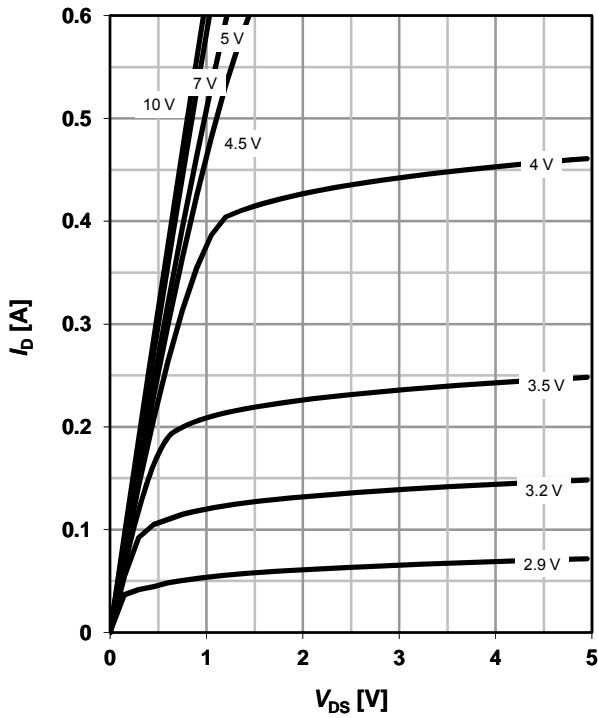

6 Typ. drain-source on resistance

$R_{DS(on)} = f(I_D); T_j = 25\text{ }^\circ\text{C}$

parameter: V_{GS}

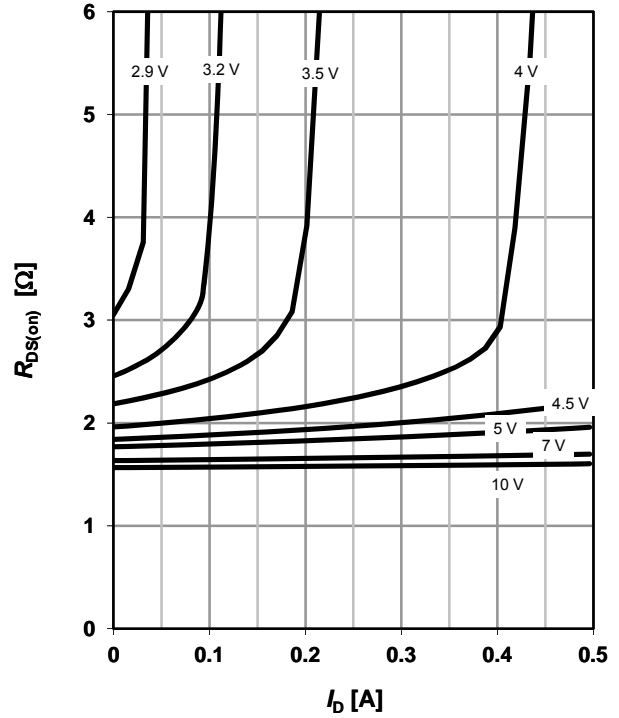

7 Typ. transfer characteristics

$I_D = f(V_{GS}); |V_{DS}| > 2|I_D|R_{DS(on)max}$

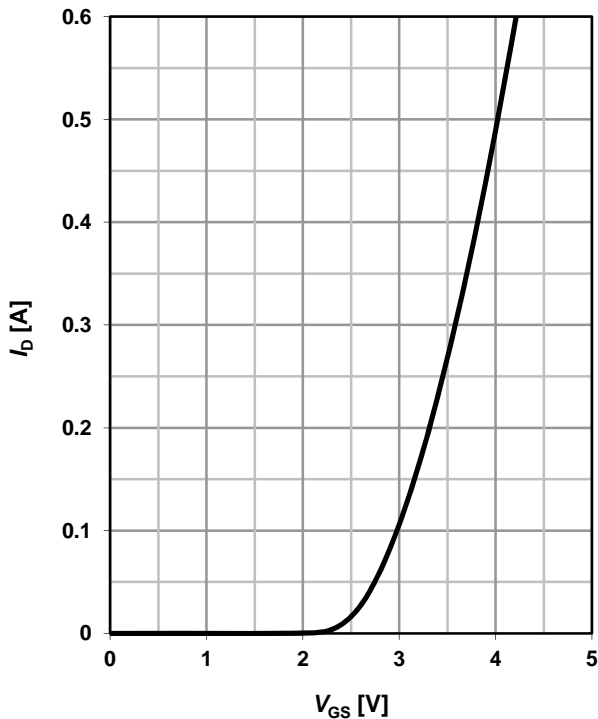

8 Typ. forward transconductance

$g_{fs} = f(I_D); T_j = 25\text{ }^\circ\text{C}$

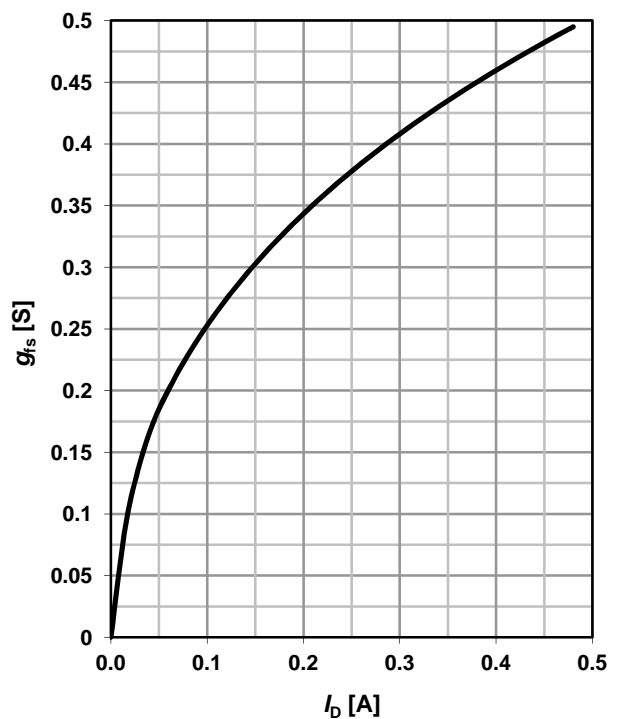

9 Drain-source on-state resistance

$R_{DS(on)}=f(T_j); I_D=0.3\text{ A}; V_{GS}=10\text{ V}$

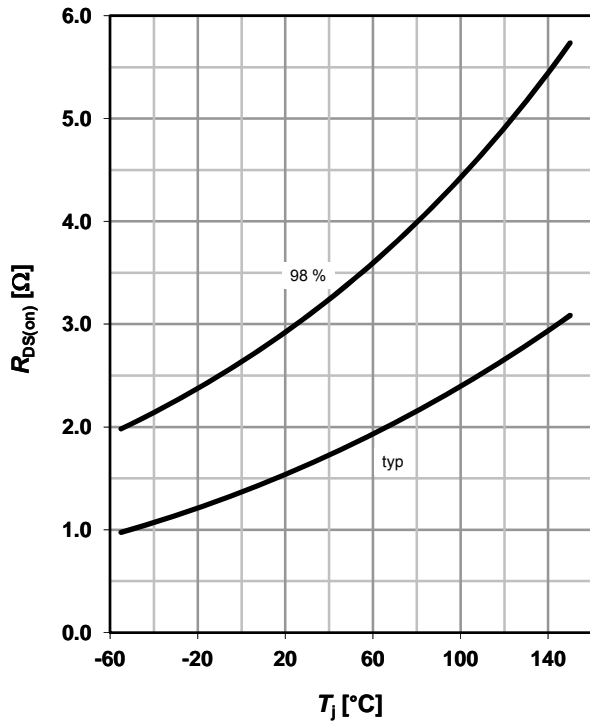

10 Typ. gate threshold voltage

$V_{GS(th)}=f(T_j); V_{DS}=V_{GS}; I_D=250\ \mu\text{A}$

parameter: I_D

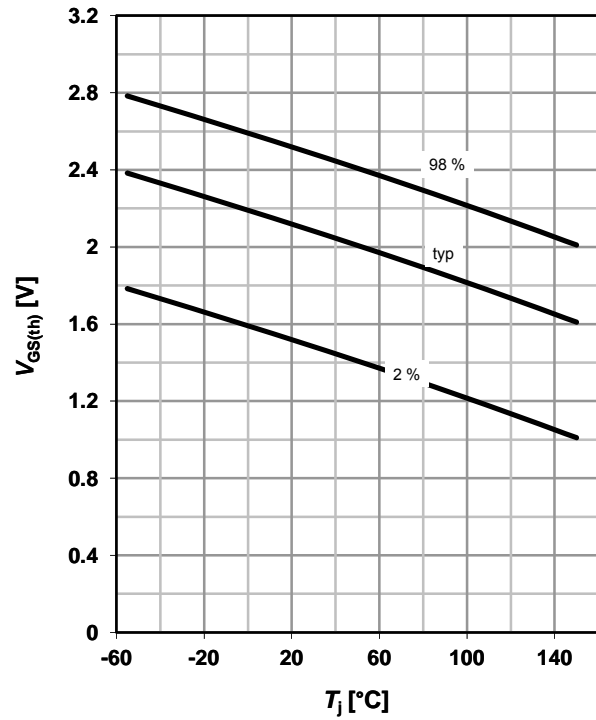

11 Typ. capacitances

$C=f(V_{DS}); V_{GS}=0\text{ V}; f=1\text{ MHz}; T_j=25^\circ\text{C}$

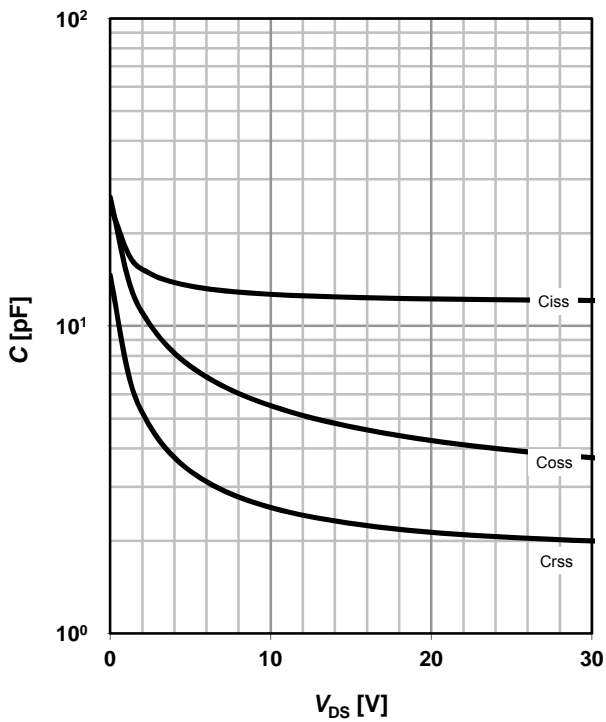

12 Forward characteristics of reverse diode

$I_F=f(V_{SD})$

parameter: T_j

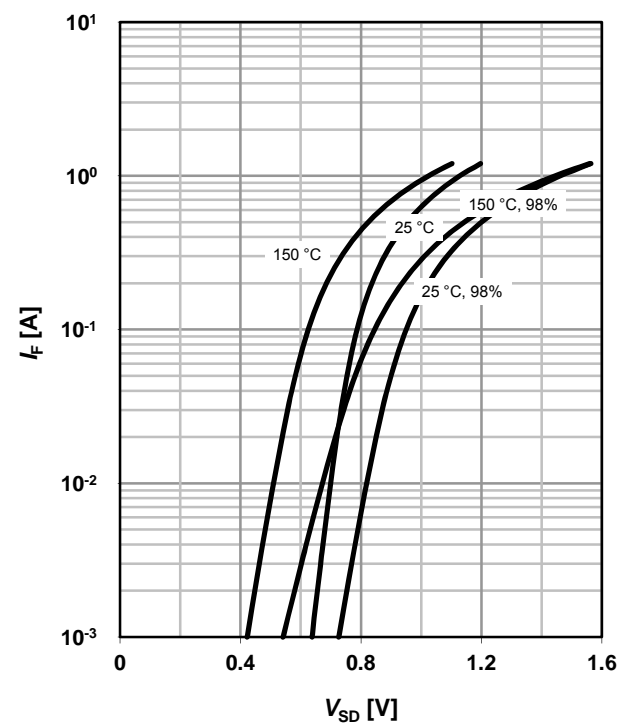

13 Avalanche characteristics

$I_{AS}=f(t_{AV}); R_{GS}=25\Omega$

parameter: $T_{j(\text{start})}$

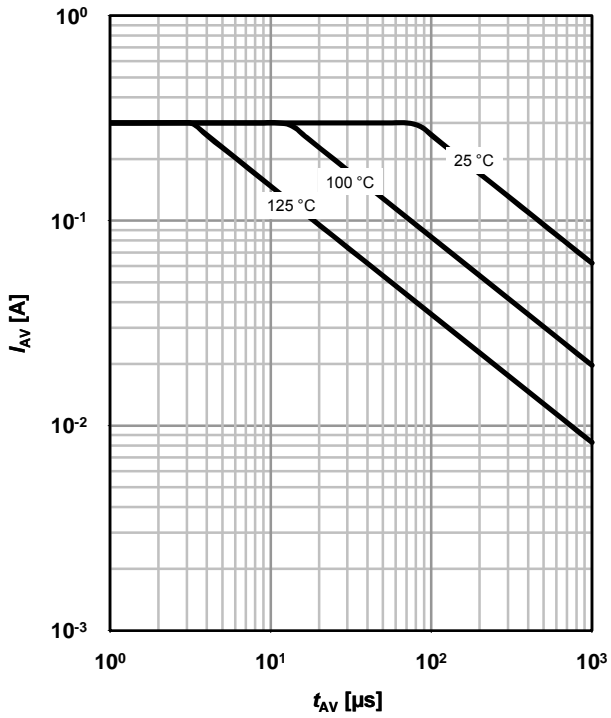

14 Typ. gate charge

$V_{GS}=f(Q_{\text{gate}}); I_D=0.5\text{ A pulsed}$

parameter: V_{DD}

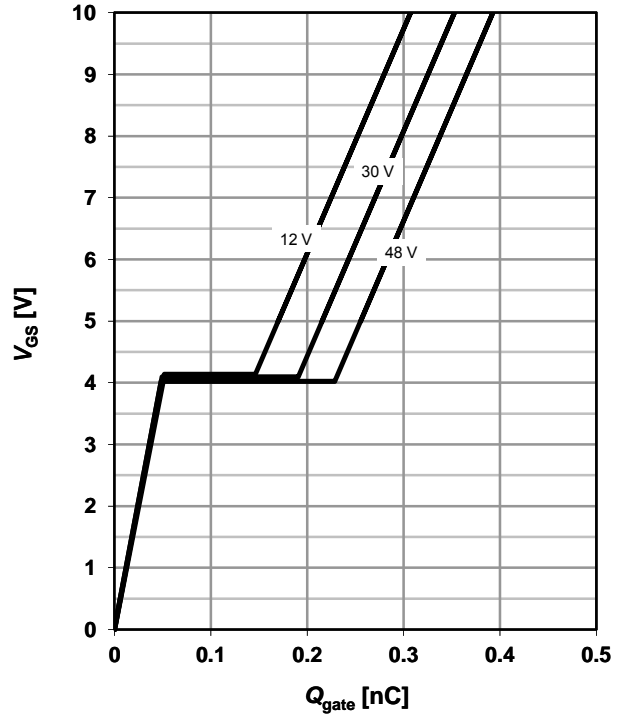

15 Drain-source breakdown voltage

$V_{BR(DSS)}=f(T_j); I_D=250\ \mu\text{A}$

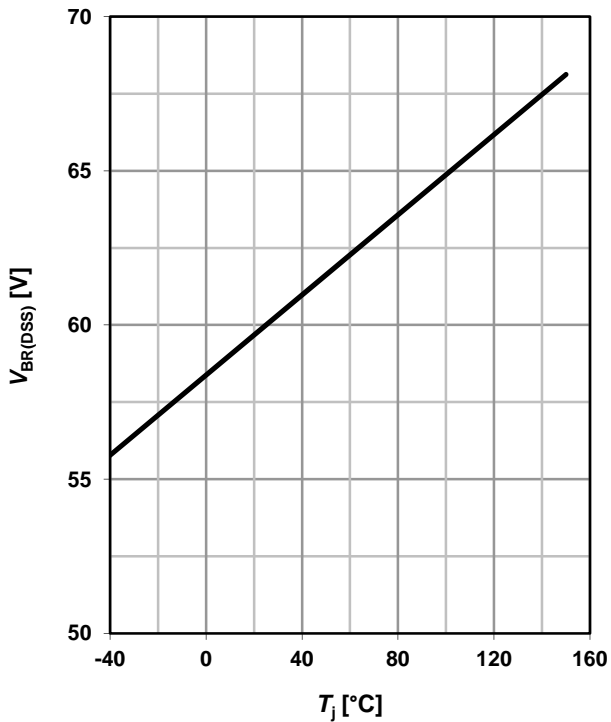

Package Outline:

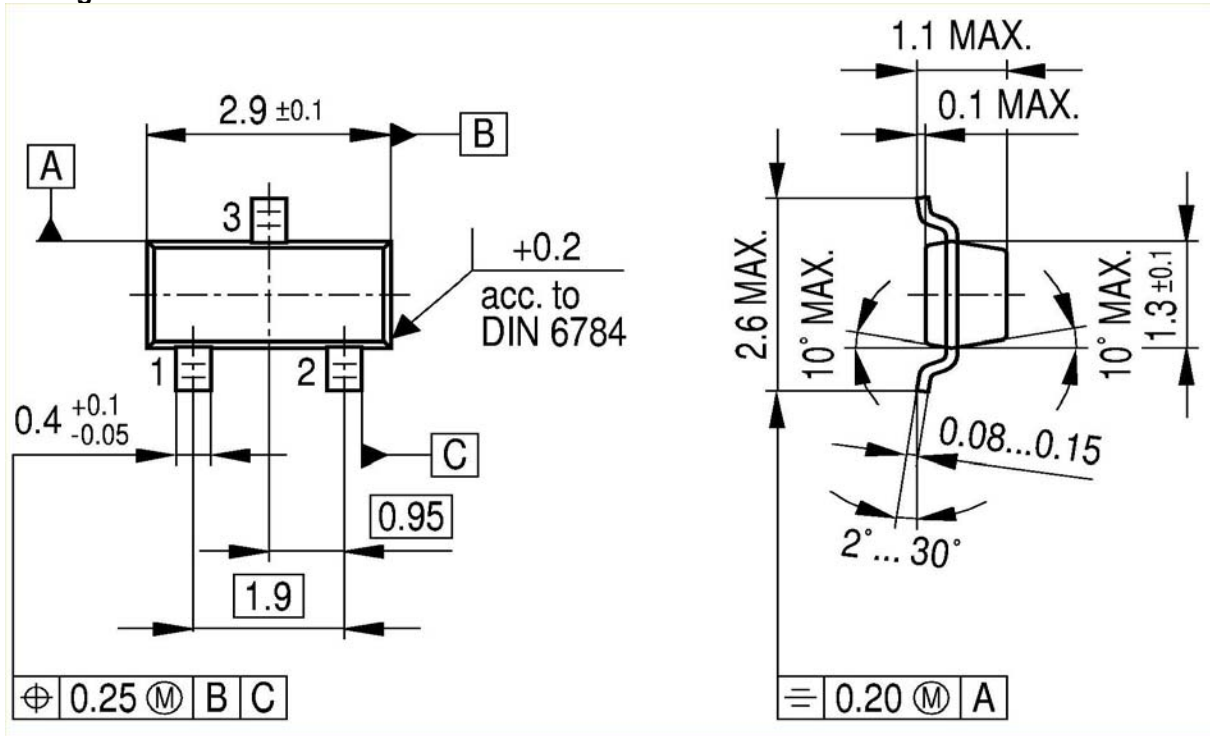

Footprint:

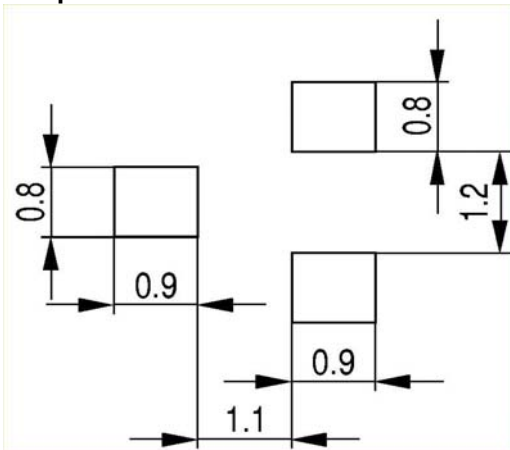

Packing:

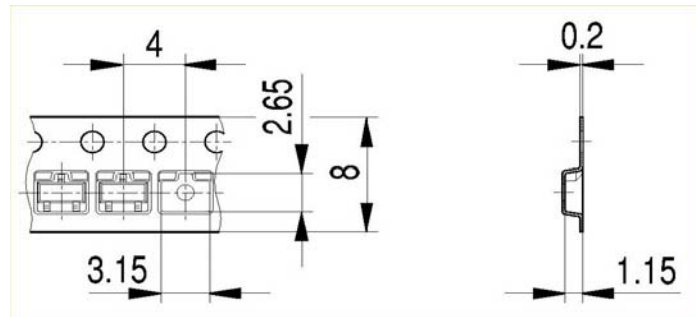

Dimensions in mm

Published by
Infineon Technologies AG
81726 Munich, Germany
© 2008 Infineon Technologies AG
All Rights Reserved.

Legal Disclaimer

The information given in this document shall in no event be regarded as a guarantee of conditions or characteristics. With respect to any examples or hints given herein, any typical values stated herein and/or any information regarding the application of the device, Infineon Technologies hereby disclaims any and all warranties and liabilities of any kind, including without limitation, warranties of non-infringement of intellectual property rights of any third party.

Information

For further information on technology, delivery terms and conditions and prices, please contact the nearest Infineon Technologies Office (www.infineon.com).

Warnings

Due to technical requirements, components may contain dangerous substances. For information on the types in question, please contact the nearest Infineon Technologies Office.

Infineon Technologies components may be used in life-support devices or systems only with the express written approval of Infineon Technologies, if a failure of such components can reasonably be expected to cause the failure of that life-support device or system or to affect the safety or effectiveness of that device or system. Life support devices or systems are intended to be implanted in the human body or to support and/or maintain and sustain and/or protect human life. If they fail, it is reasonable to assume that the health of the user or other persons may be endangered.

Данный компонент на территории Российской Федерации

Вы можете приобрести в компании MosChip.

Для оперативного оформления запроса Вам необходимо перейти по данной ссылке:

<http://moschip.ru/get-element>

Вы можете разместить у нас заказ для любого Вашего проекта, будь то серийное производство или разработка единичного прибора.

В нашем ассортименте представлены ведущие мировые производители активных и пассивных электронных компонентов.

Нашей специализацией является поставка электронной компонентной базы двойного назначения, продукции таких производителей как XILINX, Intel (ex.ALTERA), Vicor, Microchip, Texas Instruments, Analog Devices, Mini-Circuits, Amphenol, Glenair.

Сотрудничество с глобальными дистрибьюторами электронных компонентов, предоставляет возможность заказывать и получать с международных складов практически любой перечень компонентов в оптимальные для Вас сроки.

На всех этапах разработки и производства наши партнеры могут получить квалифицированную поддержку опытных инженеров.

Система менеджмента качества компании отвечает требованиям в соответствии с ГОСТ Р ИСО 9001, ГОСТ РВ 0015-002 и ЭС РД 009

Офис по работе с юридическими лицами:

105318, г.Москва, ул.Щербаковская д.3, офис 1107, 1118, ДЦ «Щербаковский»

Телефон: +7 495 668-12-70 (многоканальный)

Факс: +7 495 668-12-70 (доб.304)

E-mail: info@moschip.ru

Skype отдела продаж:

moschip.ru

moschip.ru_4

moschip.ru_6

moschip.ru_9