

EAO – Your Expert Partner for  
Human Machine Interfaces

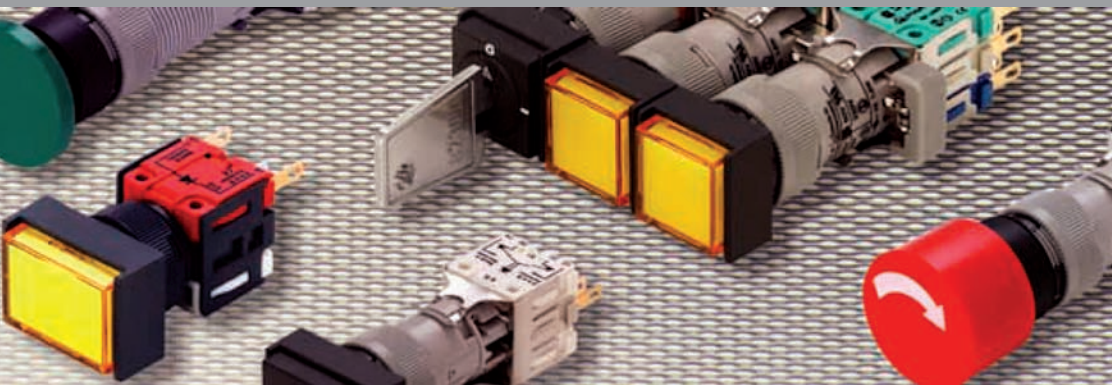

## EAO Product Information

Series Swisstac



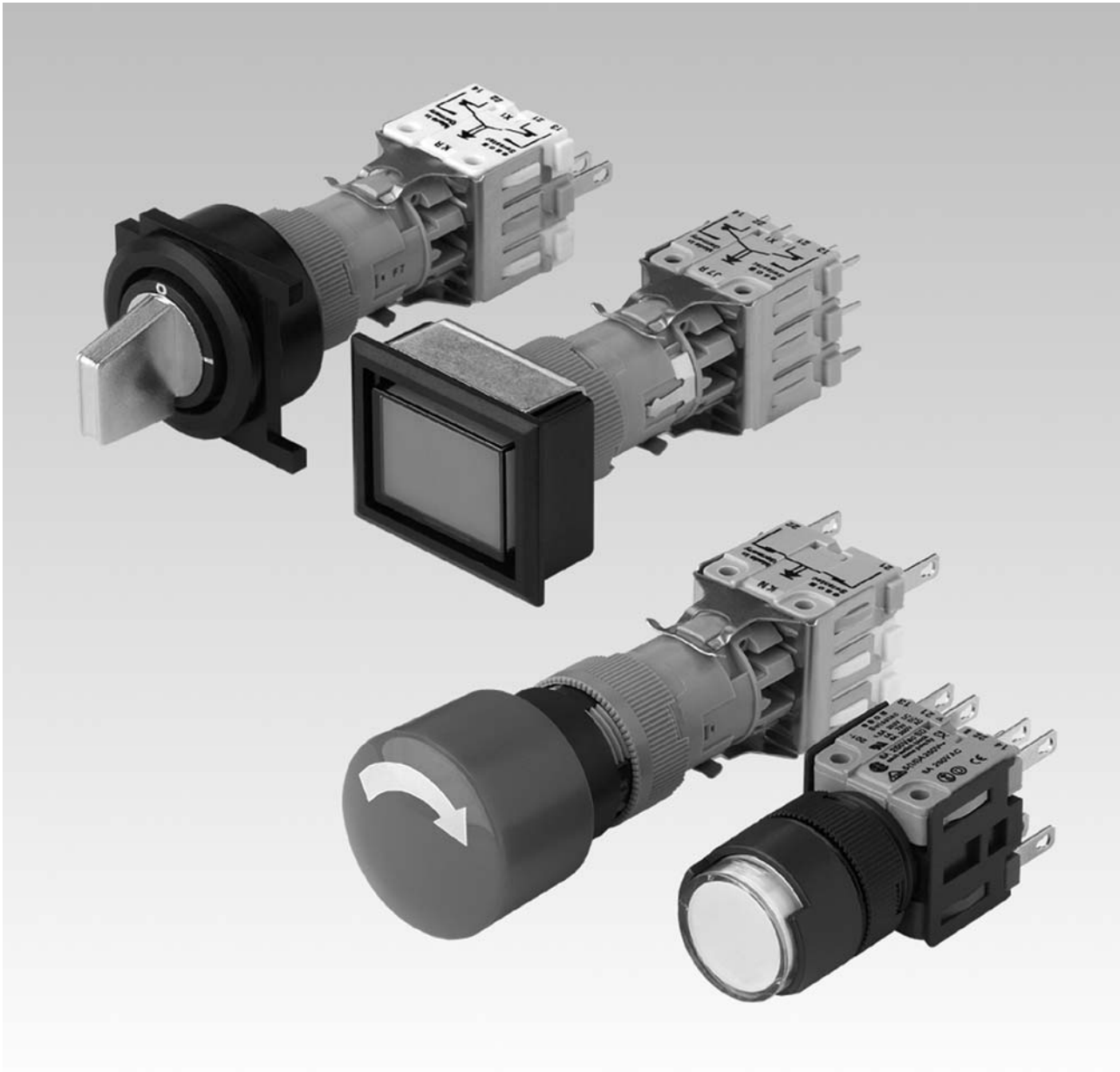

Description .....	3
Product Assembly .....	4
Mounting instruction .....	5
Devices raised mounting .....	10
Devices flush mounting .....	39
Accessories.....	54
Technical Data.....	75
Switch interlock system.....	79
Application guidelines.....	81
Marking .....	82
Drawings.....	83
Index.....	108

## Product Information

**SWISSTAC - Three crucial advantages****1. Easy storage in minimum space**

Every SWISSTAC switch can be altered very simply any number of times, and afterwards added to, modified or adapted. This highly modular concept means that only a few subassemblies reducing storage costs.

**2. All connections on one plane**

All terminals are arranged at the same level, are clearly laid out and fully accessible even when in close-packed arrays. Three colours provide optical help to make connections easier.

**2. Ideal for switch interlock systems**

SWISSTAC switches can be mechanically combined in many ways to form switch interlock systems and in fact in rows of up to 20 switches. This means that complicated protection and relay interlocks are unnecessary. Individual and irregular spacings between the switches of an array are no problem either.

**General notes**

SWISSTAC, a modularly constructed control switch system, offers the user a wide range of products: Buzzers, illuminated pushbuttons and pushbuttons, indicators, emergency-stop switches, push-pull illuminated switches, keylock switches and selector switches, as well as switch interlock systems in the front-facing protection classes IP 40 and IP 65.

The front dimensions of the switch units are: 18 mm dia., 18 x 18 mm, 18 x 24 mm, 24 mm dia.. For flush mounting, dimensions 25 mm dia., 24 x 24 mm, 24 x 30 mm are also available.

Our products are marked with the internationally approved CE low-voltage safety standard.

**Design**

SWISSTAC switches are of modular construction and are divided into the following three groups:

- Front section : Man/switch interface and status indicator. Two-parts lens for engraving, film insert or printing.
- Intermediate section : Latching/ puls facility, lamp holder, latch holder. Intermediate section with switching mechanism and lamp holder which is available in two versions T5.5 1.2 W max. and T1<sup>3</sup>/<sub>4</sub> Midget Groove 1.2 W max..
- Terminal block : Up to a max. of five switching elements can be joined together in one terminal block. Are supplied mounted serially on intermediate sections. Can be disassembled easily for wiring.

**Marking**

For further information about engraving, stamping and film inserts see part Marking.

**Illumination**

The T1<sup>3</sup>/<sub>4</sub> MG and T5.5 incandescent (filament) lamp (6, 12, 24, 28, 36, 48 V) ensures perfect illumination of the lenses, which are supplied in various colours.

Where supply voltages are over 48 V, a voltage-reduction element (external protective series resistor) must be used.

T1<sup>3</sup>/<sub>4</sub> MG and T5.5 Single-Chip LED (6, 12, 24, 28, 48 V) are also available in blue, green, red, white or yellow.

Do not solder the terminals directly, because of the high surface temperature.

Luminosity and wave length scattering caused by the technology used in the LED manufacturing processes may lead to visual differences in our products.

**Position indication**

The status of a maintained action switch can be determined by the position of the lens.

**Keylock switch**

Standard lock number is B2 300. We supply B2 300 without specifications of the lock numbers. When ordering this additional designation should be quoted. Four further standard locks are B2 301 ... B2 304. A further 95 locks are available in or without pass-partout version on request.

Two keys are supplied with each keylock switch.

Spare keys for standard locks may be ordered by quoting Typ-Nr. 240-2001-00 (please state the lock number).

Specimen order: 240-2001-00 B2 300

**Stop pushbutton with key to release**

Standard lock number is B2 390. Four further standard locks are B2 391 ... B2 394. When ordering this additional designation should be quoted.

Two keys are supplied with each keylock switch.

Spare keys for standard locks may be ordered by quoting Typ-Nr. 240-3001-00 (please state the lock number).

Specimen order: 240-3001-00 B2 390

**Emergency-stop pushbutton, foolproof with key to release**

KABA safety lock. Standard lock number is 1001. Spare keys may be ordered under Typ-Nr. 240-4001-00 1001.

*We reserve the right to modify technical data  
All dimensions in mm*

## Pushbutton illuminative, raised mounting

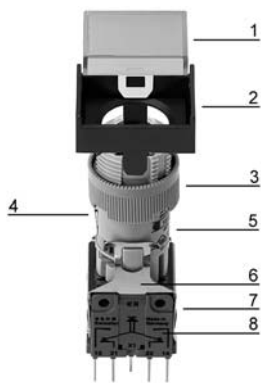

- 1 Lens
- 2 Front bezel
- 3 Fixing nut
- 4 Spring with pin for changing from maintained to momentary action
- 5 Intermediate section
- 6 Holder for switching element
- 7 Switching element block
- 8 Switching element

## Pushbutton illuminative, flush mounting

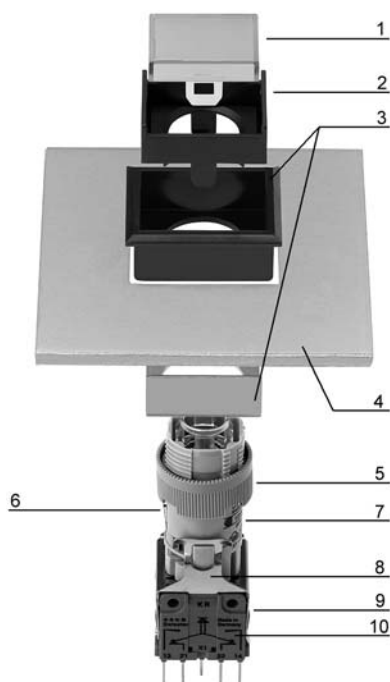

- 1 Lens
- 2 Front bezel
- 3 Front bezel set, flush mounting
- 4 Front panel
- 5 Fixing nut
- 6 Spring with pin for changing from maintained to momentary action
- 7 Intermediate section
- 8 Holder for switching element
- 9 Switching element block
- 10 Switching element

## Indicator 30 - 70 mm

The switch is mounted in a fascia or control panel in two steps:

1. Insert indicator from the back side in fascia/control panel.
2. Snap on bezel and tighten fixing nut.

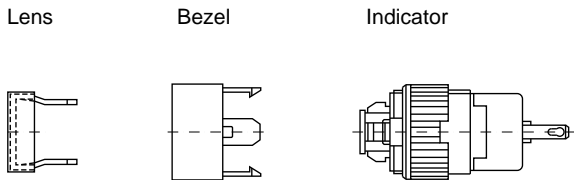

## Indicator 30 - 70 mm, sealing gland and sealing ring

The press ring is fitted between gland and lens. The seal is effective when the lens is snapped into place.

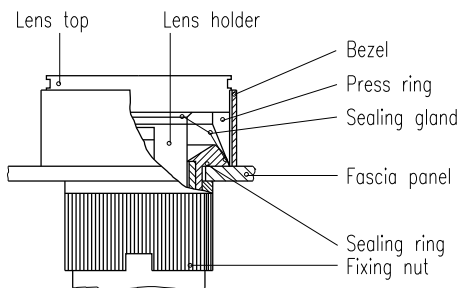

## Buzzer 30 - 55 mm

The buzzer is mounted in a fascia or control panel in two steps:

1. Insert buzzer from the back side in fascia/control panel.
2. Snap on bezel and tighten fixing nut.

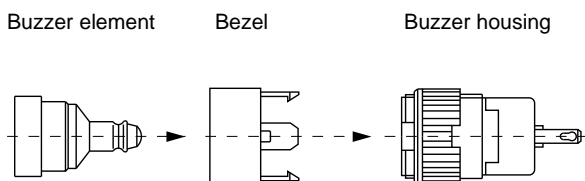

## Pushbutton illuminated 35 mm

The switch is mounted in a fascia or control panel in three steps:

1. Detach terminal block as in drawing, remove fixing nut.
2. Insert switch from the front in fascia/control panel.
3. Reassemble the switch in the reverse order.

To detach terminal block

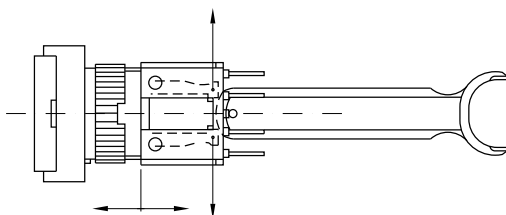

Note: Type-identification on legs of actuator !

## Pushbutton illuminated 55 - 70 mm

The switch is mounted in a fascia or control panel in two steps:

1. Insert switch from the back side in fascia/control panel.
2. Snap on bezel and tighten fixing nut.

Lens                      Bezel                      Illuminated pushbutton

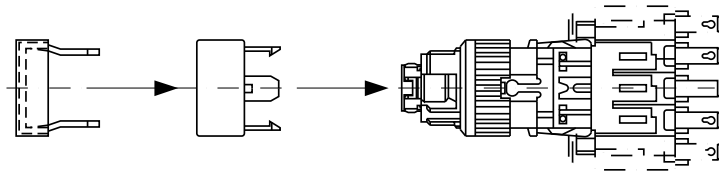

## Pushbutton illuminated 55 - 70 mm, sealing gland and sealing ring

The first time the button is pressed, the gland is forced into its groove and becomes effective.

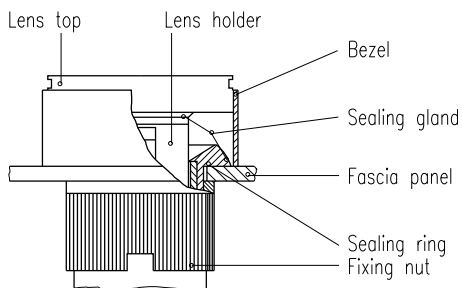

## Stop pushbutton 55 - 70 mm, twist to unlock

The switch is mounted in a fascia or control panel in three steps:

1. Detach front section just in released position, as in drawing.
2. Insert switch from the back side in fascia/control panel.
3. Snap on front section and tighten fixing nut.

Zero position                      Legend plate                      Wiring diagram

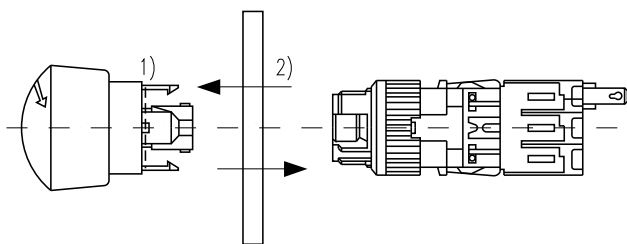

### Important for protection class IP 65 !

With models to IP 65, the sealing ring <sup>1)</sup> is already fitted. This must be removed if the SWISSTAC emergency-stop legend plate (IP 65 model) is used.

Sealing ring <sup>2)</sup> is fitted as standard in models to IP 65.



## Stop pushbutton 55 - 70 mm, key to unlock

The switch is mounted in a fascia or control panel in three steps:

1. Detach front section just in released position, as in drawing.
2. Insert switch from the back side in fascia/control panel.
3. Snap on front section and tighten fixing nut.

Zero position

Legend plate

Wiring diagram

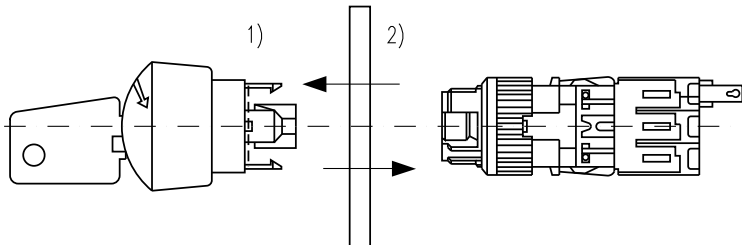

### Important for protection class IP 65 !

With models to IP 65, the sealing ring <sup>1)</sup> is already fitted. This must be removed if the SWISSTAC emergency-stop legend plate (IP 65 model) is used.

Sealing ring <sup>2)</sup> is fitted as standard in models to IP 65.

## Emergency-stop switch foolproof, EN IEC 60947-5-5

Note !

Mounting : The torque with which the fixing nut ist tightened must not exceed 50 Ncm.

Dismounting : Dismantling of switching element just with dismantling tool.

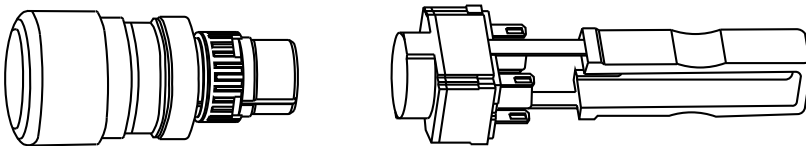

## Keylock switch 45 mm

The switch is mounted in a fascia or control panel in three steps:

1. Detach terminal block as in drawing, remove fixing nut.
2. Insert switch from the front in fascia/control panel.
3. Reassemble the switch in the reverse order.

To detach terminal block

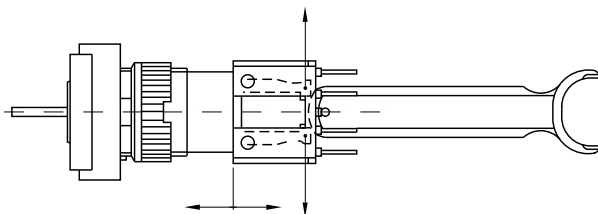

## Keylock switch 55 mm

The switch is mounted in a fascia or control panel in three steps:

1. Remove front section as in drawing.
2. Insert switch from the back side in fascia/control panel.
3. Snap on front section (see note) and tighten fixing nut.

Zero position

Wiring diagram

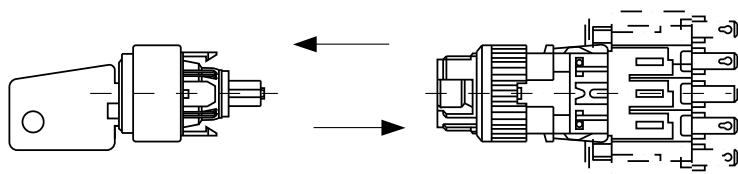

Note !  
To assemble, the key must be at the zero position. The symbol 0 is at the top, and on the terminal block the circuit diagram is uppermost.

## Keylock switch 70 mm

The switch is mounted in a fascia or control panel in three steps:

1. Remove front section as in drawing.
2. Insert switch from the back side in fascia/control panel.
3. Snap on front section (see note) and tighten fixing nut.

Zero position

Wiring diagram

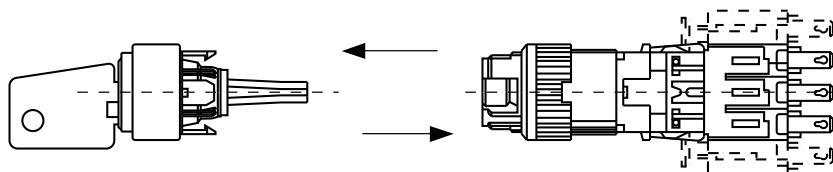

Note !  
To assemble, the key must be at the zero position. The symbol 0 is at the top, and on the terminal block the circuit diagram is uppermost.

## Selector switch 45 mm

The switch is mounted in a fascia or control panel in three steps:

1. Detach terminal block as in drawing, remove fixing nut.
2. Insert switch from the front in fascia/control panel.
3. Reassemble the switch in the reverse order.

To detach terminal block

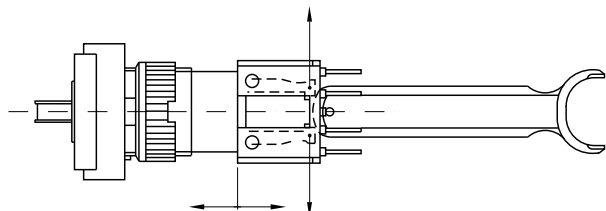

## Selector switch 55 mm

The switch is mounted in a fascia or control panel in three steps:

1. Remove front section as in drawing.
2. Insert switch from the back side in fascia/control panel.
3. Snap on front section (see note) and tighten fixing nut.

Zero position

Wiring diagram

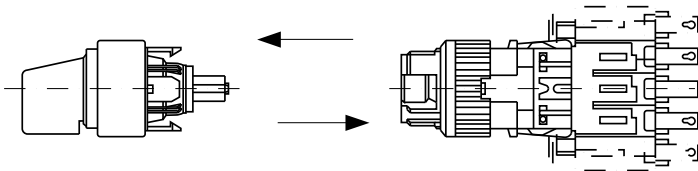

Note !

To assemble, the lever must be at the zero position. The symbol 0 is at the top, and on the terminal block the circuit diagram is uppermost.

## Selector switch 70 mm

The switch is mounted in a fascia or control panel in three steps:

1. Remove front section as in drawing.
2. Insert switch from the back side in fascia/control panel.
3. Snap on front section (see note) and tighten fixing nut.

Zero position

Wiring diagram

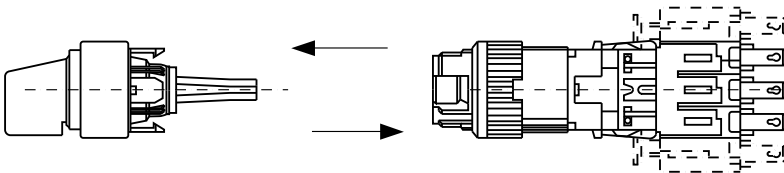

Note !

To assemble, the lever must be at the zero position. The symbol 0 is at the top, and on the terminal block the circuit diagram is uppermost.

## Illuminated push-pull pushbutton 45 mm

The switch is mounted in a fascia or control panel in three steps:

1. Detach terminal block as in drawing, remove fixing nut.
2. Insert switch from the front in fascia/control panel.
3. Reassemble the switch in the reverse order.

Push-pull knob

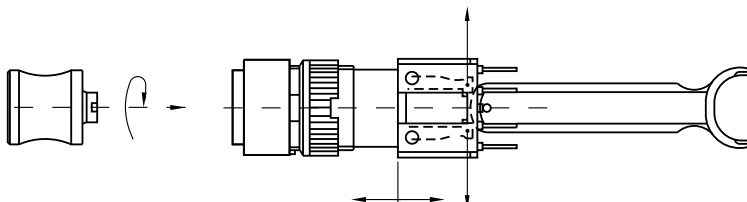

To detach terminal block



## Indicator actuator 35 mm



### Essential Accessories:

-  Lamp element block for 35 mm page 66
-  Lens plastic for button 35 mm page 54
-  Single-LED page 70

	Front protection	$\varnothing$ 18 x 18 mm Typ-Nr.	$\varnothing$ 18 x 24 mm Typ-Nr.	$\varnothing$ 18 mm Typ-Nr.	Mounting dimensions	Technical drawing	Circuit drawing	
<b>Indicator actuator 35 mm</b>	IP 40	<b>690-4000-00</b>	<b>690-6000-00</b>	<b>690-2000-00</b>	5	5	2	0.004
Lampholder T1 $\frac{3}{4}$ MG	IP 65	<b>690-4000-W0</b>	<b>690-6000-W0</b>	<b>690-2000-W0</b>	6	5	2	0.005

Mounting dimensions from page 84, Technical drawing from page 88, Circuit drawing from page 99



## Indicator actuator 30 - 70 mm

Protection degree IP 40/IP 65 is determined by front bezel and lens

Actuators usable for front dimensions:  $\varnothing$  24 x 24 mm |  $\varnothing$  18 x 18 mm |  $\varnothing$  18 x 24 mm | 24 mm dia. | 18 mm dia.



### Essential Accessories:

-  Front bezel for buttons 30 - 70 mm and 55 - 70 mm page 61
-  Lens plastic for buttons 30 - 70 mm and 55 - 70 mm page 55
-  Single-LED page 70

	Mounting depth	Terminals	Typ-Nr.	Mounting dimensions	Technical drawing	Circuit drawing	
<b>Indicator actuator 30 - 70 mm</b>	30 mm	S1	<b>990-.000-K0</b>	7	18	2	0.004
Lampholder T1 $\frac{3}{4}$ MG	52 mm	P	<b>990-.000-0P</b>	7	26	2	0.007
	55 mm	S1	<b>990-.000-00</b>	7	16	2	0.007
Lampholder T5.5	45 mm	S1	<b>890-.000-K0</b>	7	15	2	0.006
	67 mm	P	<b>890-.000-0P</b>	7	17	2	0.010
	70 mm	S1	<b>890-.000-00</b>	7	19	2	0.010

Terminals: S1 = Soldering terminal (also pluggable 2.8 x 0.5 mm), P = PCB terminal



Mounting dimensions from page 84, Technical drawing from page 88, Circuit drawing from page 99

## Buzzer actuator 30 - 55 mm

Actuators usable for front dimensions:  $\varnothing$  24 x 24 mm |  $\square$  18 x 24 mm



### Essential Accessories:

-  Buzzer element page 60
-  Front bezel for Buzzer for 30- 55 mm page 62

	Front protection	Mounting depth	Terminals	Typ-Nr.	Component layout	Mounting dimensions	Technical drawing	Circuit drawing	
<b>Buzzer actuator 30 - 55 mm</b> Buzzer socket T1 <sup>3</sup> / <sub>4</sub> MG	IP 40	30 mm	S1	<b>970-000-K0</b>		11	18	1	0.004
		52 mm	P	<b>970-000-0P</b>	1	11	26	1	0.007
		64 mm	S1	<b>970-000-00</b>		11	16	1	0.007

The buzzer 55 mm is as long as the corresponding illuminated pushbutton and fits to the PCB plug-in base and multi plug housing





Terminals: S1 = Soldering terminal (also pluggable 2.8 x 0.5 mm), P = PCB terminal

Component layout from page 83, Mounting dimensions from page 84, Technical drawing from page 88, Circuit drawing from page 99

## Illuminated pushbutton actuator 35 mm



### Essential Accessories:

-  Front bezel set, flush mounting page 62
-  Lens plastic for button 35 mm page 54
-  Single-LED page 70
-  Snap-action switching element block for 35 mm page 66

	Front protection	Switching action	$\varnothing$ 18 x 18 mm Typ-Nr.	$\varnothing$ 18 x 24 mm Typ-Nr.	$\varnothing$ 18 mm Typ-Nr.	Mounting dimensions	Technical drawing	Circuit drawing	
<b>Illuminated pushbutton actuator 35 mm</b> Lampholder T1 <sup>3</sup> / <sub>4</sub> MG	IP 40	R (Ir)	<b>600-4000-00</b>	<b>600-6000-00</b>	<b>600-2000-00</b>	5	5	15	0.004
		M	<b>680-4000-00</b>	<b>680-6000-00</b>	<b>680-2000-00</b>	5	5	32	0.004
	IP 65	R (Ir)	<b>600-4000-W0</b>	<b>600-6000-W0</b>	<b>600-2000-W0</b>	6	5	15	0.005
		M	<b>680-4000-W0</b>	<b>680-6000-W0</b>	<b>680-2000-W0</b>	6	5	32	0.005

Switching action: R (Ir) = Maintained action (switchable to momentary action), M = Momentary action

Mounting dimensions from page 84, Technical drawing from page 88, Circuit drawing from page 99

## Illuminated pushbutton actuator 55 - 70 mm

Protection degree IP 40/IP 65 is determined by front bezel and lens

Actuators usable for front dimensions: □ 24 x 24 mm | □ 18 x 18 mm | □ 18 x 24 mm | 24 mm dia. | 18 mm dia.



### Essential Accessories:

- ☞ Front bezel for buttons 30 - 70 mm and 55 - 70 mm page 61
- ☞ Lens plastic for buttons 30 - 70 mm and 55 - 70 mm page 55
- ☞ Single-LED page 70

	Mounting depth	Contacts	Switching action	Terminals	Typ-Nr.	Component layout	Mounting dimensions	Technical drawing	Circuit drawing	
<b>Illuminated pushbutton actuator 55 - 70 mm</b> Lampholder T1 3/4 MG	52 mm	1 NC + 1 NO	R (Ir)	P	<b>901-.000-0P</b>	1	7 8	14	0.013	(2)
		2 NC + 2 NO	R (Ir)	P	<b>902-.000-0P</b>	1	7 8	8	0.014	
		3 NC + 3 NO	R (Ir)	P	<b>903-.000-0P</b>	1	7 8	12	0.014	
		4 NC + 4 NO	R (Ir)	P	<b>904-.000-0P</b>	1	7 8	11	0.018	
		5 NC + 5 NO	R (Ir)	P	<b>905-.000-0P</b>	1	7 8	6	0.021	
	55 mm	1 NC + 1 NO	R (Ir)	S1	<b>901-.000-00</b>		7 4	14	0.013	
		2 NC + 2 NO	R (Ir)	S1	<b>902-.000-00</b>		7 4	8	0.014	
		3 NC + 3 NO	R (Ir)	S1	<b>903-.000-00</b>		7 4	12	0.015	
		4 NC + 4 NO	R (Ir)	S1	<b>904-.000-00</b>		7 4	11	0.019	
		5 NC + 5 NO	R (Ir)	S1	<b>905-.000-00</b>		7 4	6	0.022	
Lampholder T5.5	67 mm	1 NC + 1 NO	R (Ir)	P	<b>801-.000-0P</b>	1	7 12	14	0.015	
		2 NC + 2 NO	R (Ir)	P	<b>802-.000-0P</b>	1	7 12	8	0.016	
		3 NC + 3 NO	R (Ir)	P	<b>803-.000-0P</b>	1	7 12	12	0.017	
		4 NC + 4 NO	R (Ir)	P	<b>804-.000-0P</b>	1	7 12	11	0.020	
		5 NC + 5 NO	R (Ir)	P	<b>805-.000-0P</b>	1	7 12	6	0.023	
	70 mm	1 NC + 1 NO	R (Ir)	S1	<b>801-.000-00</b>		7 11	14	0.015	
		2 NC + 2 NO	R (Ir)	S1	<b>802-.000-00</b>		7 11	8	0.016	
		3 NC + 3 NO	R (Ir)	S1	<b>803-.000-00</b>		7 11	12	0.017	
		4 NC + 4 NO	R (Ir)	S1	<b>804-.000-00</b>		7 11	11	0.021	
		5 NC + 5 NO	R (Ir)	S1	<b>805-.000-00</b>		7 11	6	0.024	

Contacts: NC = Normally closed, NO = Normally open

Switching action: R (Ir) = Maintained action (switchable to momentary action)

Terminals: P = PCB terminal, S1 = Soldering terminal (also pluggable 2.8 x 0.5 mm)

Component layout from page 83, Mounting dimensions from page 84, Technical drawing from page 88, Circuit drawing from page 99

## Stop pushbutton 55 - 70 mm



	Front protection	Mounting depth	Mushroom had cap	Contacts	Terminals	Ø 24 mm Typ-Nr.	Component layout	Mounting dimensions	Technical drawing	Circuit drawing	
<b>Stop pushbutton 55 - 70 mm</b> Key to unlock clockwise standard lock B2 390	IP 40	52 mm	Plastic red	1 NC	P	<b>961+2401-0P</b>	1	14	31	57	0.030
				2 NC	P	<b>962+2401-0P</b>	1	14	31	56	0.031
				3 NC	P	<b>963+2401-0P</b>	1	14	31	55	0.032
		64 mm	Plastic red	1 NC	S1	<b>961+2401-00</b>		14	24	57	0.030
				2 NC	S1	<b>962+2401-00</b>		14	24	56	0.031
				3 NC	S1	<b>963+2401-00</b>		14	24	55	0.032
		67 mm	Plastic red	1 NC	P	<b>861+2401-0P</b>	1	14	40	57	0.033
				2 NC	P	<b>862+2401-0P</b>	1	14	40	56	0.034
				3 NC	P	<b>863+2401-0P</b>	1	14	40	55	0.035
		70 mm	Plastic red	1 NC	S1	<b>861+2401-00</b>		14	39	57	0.033
				2 NC	S1	<b>862+2401-00</b>		14	39	56	0.034
				3 NC	S1	<b>863+2401-00</b>		14	39	55	0.035
	IP 65	52 mm	Plastic red	1 NC	P	<b>961+2401-WP</b>	1	15	31	57	0.030
				2 NC	P	<b>962+2401-WP</b>	1	15	31	56	0.031
				3 NC	P	<b>963+2401-WP</b>	1	15	31	55	0.032
		64 mm	Plastic red	1 NC	S1	<b>961+2401-W0</b>		15	24	57	0.030
				2 NC	S1	<b>962+2401-W0</b>		15	24	56	0.031
				3 NC	S1	<b>963+2401-W0</b>		15	24	55	0.032
		67 mm	Plastic red	1 NC	P	<b>861+2401-WP</b>	1	15	40	57	0.033
				2 NC	P	<b>862+2401-WP</b>	1	15	40	56	0.034
3 NC				P	<b>863+2401-WP</b>	1	15	40	55	0.035	
70 mm		Plastic red	1 NC	S1	<b>861+2401-W0</b>		15	39	57	0.033	
			2 NC	S1	<b>862+2401-W0</b>		15	39	56	0.034	
			3 NC	S1	<b>863+2401-W0</b>		15	39	55	0.035	

Continuation see next page

Continued from previous page

	Front protection	Mounting depth	Mushroom had cap	Contacts	Terminals	Ø 24 mm Typ-Nr.	Component layout	Mounting dimensions	Technical drawing	Circuit drawing	(%)
<b>Stop pushbutton 55 - 70 mm</b> Twist to unlock clockwise	IP 40	52 mm	Plastic red	1 NC	P	<b>951+2000-0P</b>	1	14	31	57	0.018
				2 NC	P	<b>952+2000-0P</b>	1	14	31	56	0.019
				3 NC	P	<b>953+2000-0P</b>	1	14	31	55	0.020
		55 mm	Plastic red	1 NC	S1	<b>951+2000-00</b>		14	24	57	0.018
				2 NC	S1	<b>952+2000-00</b>		14	24	56	0.019
				3 NC	S1	<b>953+2000-00</b>		14	24	55	0.020
		67 mm	Plastic red	1 NC	P	<b>851+2000-0P</b>	1	14	40	57	0.021
				2 NC	P	<b>852+2000-0P</b>	1	14	40	56	0.022
				3 NC	P	<b>853+2000-0P</b>	1	14	40	55	0.023
		70 mm	Plastic red	1 NC	S1	<b>851+2000-00</b>		14	39	57	0.021
				2 NC	S1	<b>852+2000-00</b>		14	39	56	0.022
				3 NC	S1	<b>853+2000-00</b>		14	39	55	0.023
	IP 65	52 mm	Plastic red	1 NC	P	<b>951+2000-WP</b>	1	15	31	57	0.018
				2 NC	P	<b>952+2000-WP</b>	1	15	31	56	0.019
				3 NC	P	<b>953+2000-WP</b>	1	15	31	55	0.020
		64 mm	Plastic red	1 NC	S1	<b>951+2000-W0</b>		15	24	57	0.018
				2 NC	S1	<b>952+2000-W0</b>		15	24	56	0.019
				3 NC	S1	<b>953+2000-W0</b>		15	24	55	0.020
		67 mm	Plastic red	1 NC	P	<b>851+2000-WP</b>	1	15	40	57	0.021
				2 NC	P	<b>852+2000-WP</b>	1	15	40	56	0.022
				3 NC	P	<b>853+2000-WP</b>	1	15	40	55	0.023
		70 mm	Plastic red	1 NC	S1	<b>851+2000-W0</b>		15	39	57	0.021
				2 NC	S1	<b>852+2000-W0</b>		15	39	56	0.022
				3 NC	S1	<b>853+2000-W0</b>		15	39	55	0.023

Note :

We recommend to use location strip no. 260-0020-00 for anti-twisting of the front bezel.

At momentary position the overturning force is max. 60 Ncm.

Other keylock numbers on request

Contacts: NC = Normally closed

Terminals: P = PCB terminal, S1 = Soldering terminal (also pluggable 2.8 x 0.5 mm)

Component layout from page 83, Mounting dimensions from page 84, Technical drawing from page 88, Circuit drawing from page 99



## Emergency-stop pushbutton, foolproof EN IEC 60947-5-5

Application as per DIN EN ISO 13850 and EN 60204-1



	Front protection	Mounting depth	Mushroom had cap	Contacts	Terminals	Ø 27 mm Typ-Nr.	Mounting dimensions	Technical drawing	Circuit drawing	
<b>Emergency-stop pushbutton, foolproof EN IEC 60947-5-5</b> Position indication ring black Key to unlock clockwise Standard lock 1001	IP 65	41 mm	Plastic red	1 NC	S1	<b>561-8101-W0</b>	3	3	54	0.047
				1 NC + 1 NO	S1	<b>563-8101-W0</b>	3	3	58	0.047
				2 NC	S1	<b>562-8101-W0</b>	3	3	53	0.047
Position indication ring black Twist to unlock clockwise	IP 65	41 mm	Plastic red	1 NC	S1	<b>551-8000-W0</b>	3	3	54	0.025
				1 NC + 1 NO	S1	<b>553-8000-W0</b>	3	3	58	0.025
				2 NC	S1	<b>552-8000-W0</b>	3	3	53	0.025

Mounting hint: Starting torque for fixing nut max. 50 Ncm

Other lock numbers on request

Contacts: NC = Normally closed, NO = Normally open

Terminals: S1 = Soldering terminal (also pluggable 2.8 x 0.5 mm)



Mounting dimensions from page 84, Technical drawing from page 88, Circuit drawing from page 99

## Mushroom-head pushbutton actuator 55 - 70 mm

Actuators usable for front dimensions:  $\square$  24 x 24 mm |  $\square$  18 x 24 mm | 24 mm dia.



### Essential Accessories:

-  Front bezel for Mushroom-head pushbutton 55 - 70 mm page 61
-  Mushroom-head cap page 57

	Front protection	Mounting depth	Contacts	Switching action	Terminals	Typ-Nr.	Component layout	Mounting dimensions	Technical drawing	Circuit drawing	
<b>Mushroom-head pushbutton actuator 55 - 70 mm</b>	IP 40	52 mm	1 NC + 1 NO	R (lr)	P	<b>901-.000-0P</b>	1	8	7	13	0.013
			2 NC + 2 NO	R (lr)	P	<b>902-.000-0P</b>	1	8	7	7	0.014
			3 NC + 3 NO	R (lr)	P	<b>903-.000-0P</b>	1	8	7	9	0.014
			4 NC + 4 NO	R (lr)	P	<b>904-.000-0P</b>	1	8	7	10	0.018
			5 NC + 5 NO	R (lr)	P	<b>905-.000-0P</b>	1	8	7	5	0.021
		55 mm	1 NC + 1 NO	R (lr)	S1	<b>901-.000-00</b>		8	6	13	0.013
			2 NC + 2 NO	R (lr)	S1	<b>902-.000-00</b>		8	6	7	0.014
			3 NC + 3 NO	R (lr)	S1	<b>903-.000-00</b>		8	6	9	0.015
			4 NC + 4 NO	R (lr)	S1	<b>904-.000-00</b>		8	6	10	0.019
			5 NC + 5 NO	R (lr)	S1	<b>905-.000-00</b>		8	6	5	0.022
		67 mm	1 NC + 1 NO	R (lr)	P	<b>801-.000-0P</b>	1	8	14	13	0.015
			2 NC + 2 NO	R (lr)	P	<b>802-.000-0P</b>	1	8	14	7	0.016
			3 NC + 3 NO	R (lr)	P	<b>803-.000-0P</b>	1	8	14	9	0.017
			4 NC + 4 NO	R (lr)	P	<b>804-.000-0P</b>	1	8	14	10	0.020
			5 NC + 5 NO	R (lr)	P	<b>805-.000-0P</b>	1	8	14	5	0.023
		70 mm	1 NC + 1 NO	R (lr)	S1	<b>801-.000-00</b>		8	13	13	0.015
			2 NC + 2 NO	R (lr)	S1	<b>802-.000-00</b>		8	13	7	0.016
			3 NC + 3 NO	R (lr)	S1	<b>803-.000-00</b>		8	13	9	0.017
			4 NC + 4 NO	R (lr)	S1	<b>804-.000-00</b>		8	13	10	0.021
			5 NC + 5 NO	R (lr)	S1	<b>805-.000-00</b>		8	13	5	0.024

Contacts: NC = Normally closed, NO = Normally open

Switching action: R (lr) = Maintained action (switchable to momentary action)

Terminals: P = PCB terminal, S1 = Soldering terminal (also pluggable 2.8 x 0.5 mm)

Component layout from page 83, Mounting dimensions from page 84, Technical drawing from page 88, Circuit drawing from page 99

## Keylock switch actuator 2 positions 45 mm

Actuators usable for front dimensions:  $\varnothing$  24 x 24 mm |  $\varnothing$  18 x 18 mm |  $\square$  18 x 24 mm | 24 mm dia. | 18 mm dia.



### Essential Accessories:

Front bezel for Keylock switch and Selector switch 2 positions page 58

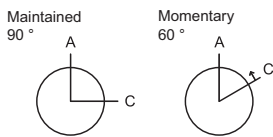

	Front protection	Mounting depth	Contacts	Switching action	Terminals	Key remove	Typ-Nr.	Component layout	Mounting dimensions	Technical drawing	Circuit drawing	
<b>Keylock switch actuator 2 positions 45 mm</b> Standard lock B2 300	IP 40	42 mm	1 NC + 1 NO	MA	P	A	<b>771-.401-0P</b>	1	9	29	47	0.022
						C + A	<b>761-.401-0P</b>	1	9	29	47	0.022
				M	P	A	<b>781-.401-0P</b>	1	9	29	41	0.022
			2 NC + 2 NO	MA	P	A	<b>772-.401-0P</b>	1	9	29	49	0.023
						C + A	<b>762-.401-0P</b>	1	9	29	49	0.023
				M	P	A	<b>782-.401-0P</b>	1	9	29	43	0.023
		45 mm	1 NC + 1 NO	MA	S1	A	<b>771-.401-00</b>		9	22	47	0.022
						C + A	<b>761-.401-00</b>		9	22	47	0.022
				M	S1	A	<b>781-.401-00</b>		9	22	41	0.022
			2 NC + 2 NO	MA	S1	A	<b>772-.401-00</b>		9	22	49	0.023
						C + A	<b>762-.401-00</b>		9	22	49	0.023
				M	S1	A	<b>782-.401-00</b>		9	22	43	0.023
	IP 65	42 mm	1 NC + 1 NO	MA	P	A	<b>771-.401-WP</b>	1	10	29	47	0.022
						C + A	<b>761-.401-WP</b>	1	10	29	47	0.022
				M	P	A	<b>781-.401-WP</b>	1	10	29	41	0.022
			2 NC + 2 NO	MA	P	A	<b>772-.401-WP</b>	1	10	29	49	0.023
						C + A	<b>762-.401-WP</b>	1	10	29	49	0.023
				M	P	A	<b>782-.401-WP</b>	1	10	29	43	0.023
		45 mm	1 NC + 1 NO	MA	S1	A	<b>771-.401-W0</b>		10	22	47	0.022
						C + A	<b>761-.401-W0</b>		10	22	47	0.022
				M	S1	A	<b>781-.401-W0</b>		10	22	41	0.022
			2 NC + 2 NO	MA	S1	A	<b>772-.401-W0</b>		10	22	49	0.023
						C + A	<b>762-.401-W0</b>		10	22	49	0.023
				M	S1	A	<b>782-.401-W0</b>		10	22	43	0.023

Other key remove and key lock number on request

Hint:

We recommend to use location strip no. 260-0020-00 for anti-twisting of the front bezel.

At momentary position the overturning force is max. 60 Ncm

Contacts: NC = Normally closed, NO = Normally open

Switching action: MA = Maintained action, M = Momentary action

Terminals: P = PCB terminal, S1 = Soldering terminal (also pluggable 2.8 x 0.5 mm)

Component layout from page 83, Mounting dimensions from page 84, Technical drawing from page 88, Circuit drawing from page 99

## Keylock switch actuator 2 positions 55 mm

Actuators usable for front dimensions:  $\square$  24 x 24 mm |  $\square$  18 x 18 mm |  $\square$  18 x 24 mm | 24 mm dia. | 18 mm dia.



### Essential Accessories:

Front bezel for Keylock switch and Selector switch 2 positions page 58

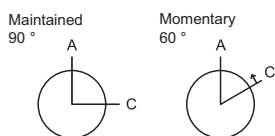

	Front protection	Mounting depth	Contacts	Switching action	Terminals	Key remove	Typ-Nr.	Component layout		Technical drawing	Circuit drawing		
								Mounting dimensions					
<b>Keylock switch actuator 2 positions 55 mm</b> Standard lock B2 300	IP 40	52 mm	1 NC + 1 NO	MA	P	A	<b>921-.401-0P</b>	1	9	27	52	0.024	
							C + A	<b>911-.401-0P</b>	1	9	27	52	0.024
			M	P	A	<b>931-.401-0P</b>	1	9	27	46	0.024		
						C + A	<b>912-.401-0P</b>	1	9	27	49	0.025	
			2 NC + 2 NO	MA	P	A	<b>922-.401-0P</b>	1	9	27	49	0.025	
							C + A	<b>912-.401-0P</b>	1	9	27	49	0.025
			M	P	A	<b>932-.401-0P</b>	1	9	27	43	0.025		
						C + A	<b>913-.401-0P</b>	1	9	27	50	0.026	
			3 NC + 3 NO	MA	P	A	<b>923-.401-0P</b>	1	9	27	50	0.026	
							C + A	<b>913-.401-0P</b>	1	9	27	50	0.026
			M	P	A	<b>933-.401-0P</b>	1	9	27	44	0.026		
						C + A	<b>914-.401-0P</b>	1	9	27	51	0.029	
		4 NC + 4 NO	MA	P	A	<b>924-.401-0P</b>	1	9	27	51	0.029		
						C + A	<b>914-.401-0P</b>	1	9	27	51	0.029	
		M	P	A	<b>934-.401-0P</b>	1	9	27	45	0.029			
					C + A	<b>915-.401-0P</b>	1	9	27	48	0.032		
		5 NC + 5 NO	MA	P	A	<b>925-.401-0P</b>	1	9	27	48	0.032		
						C + A	<b>915-.401-0P</b>	1	9	27	48	0.032	
		M	P	A	<b>935-.401-0P</b>	1	9	27	42	0.032			
					C + A	<b>915-.401-0P</b>	1	9	27	48	0.032		
		55 mm		1 NC + 1 NO	MA	S1	A	<b>921-.401-00</b>		9	20	52	0.024
								C + A	<b>911-.401-00</b>		9	20	52
				M	S1	A	<b>931-.401-00</b>		9	20	46	0.024	
							C + A	<b>912-.401-00</b>		9	20	49	0.025
2 NC + 2 NO	MA			S1	A	<b>922-.401-00</b>		9	20	49	0.025		
						C + A	<b>912-.401-00</b>		9	20	49	0.025	
M	S1			A	<b>932-.401-00</b>		9	20	43	0.025			
					C + A	<b>913-.401-00</b>		9	20	50	0.027		
3 NC + 3 NO	MA			S1	A	<b>923-.401-00</b>		9	20	50	0.027		
						C + A	<b>913-.401-00</b>		9	20	50	0.027	
M	S1			A	<b>933-.401-00</b>		9	20	44	0.027			
					C + A	<b>914-.401-00</b>		9	20	51	0.030		
4 NC + 4 NO	MA	S1	A	<b>924-.401-00</b>		9	20	51	0.030				
				C + A	<b>914-.401-00</b>		9	20	51	0.030			
M	S1	A	<b>934-.401-00</b>		9	20	45	0.030					
			C + A	<b>915-.401-00</b>		9	20	48	0.033				
5 NC + 5 NO	MA	S1	A	<b>925-.401-00</b>		9	20	48	0.033				
				C + A	<b>915-.401-00</b>		9	20	48	0.033			
M	S1	A	<b>935-.401-00</b>		9	20	42	0.033					
			C + A	<b>915-.401-00</b>		9	20	48	0.033				

Continuation see next page

Continued from previous page

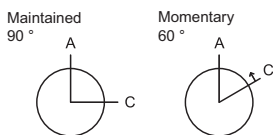

	Front protection	Mounting depth	Contacts	Switching action	Terminals	Key remove	Typ-Nr.	Component layout	Mounting dimensions	Technical drawing	Circuit drawing		
<b>Keylock switch actuator 2 positions 55 mm</b> Standard lock B2 300	IP 65	52 mm	1 NC + 1 NO	MA	P	A	<b>921-.401-WP</b>	1	10	27	52	0.024	
							C + A	<b>911-.401-WP</b>	1	10	27	52	0.024
			M	P	A	<b>931-.401-WP</b>	1	10	27	46	0.024		
						C + A	<b>931-.401-WP</b>	1	10	27	46	0.024	
			2 NC + 2 NO	MA	P	A	<b>922-.401-WP</b>	1	10	27	49	0.025	
							C + A	<b>912-.401-WP</b>	1	10	27	49	0.025
			M	P	A	<b>932-.401-WP</b>	1	10	27	43	0.025		
						C + A	<b>932-.401-WP</b>	1	10	27	43	0.025	
			3 NC + 3 NO	MA	P	A	<b>923-.401-WP</b>	1	10	27	50	0.026	
							C + A	<b>913-.401-WP</b>	1	10	27	50	0.026
			M	P	A	<b>933-.401-WP</b>	1	10	27	44	0.026		
						C + A	<b>933-.401-WP</b>	1	10	27	44	0.026	
		4 NC + 4 NO	MA	P	A	<b>924-.401-WP</b>	1	10	27	51	0.029		
						C + A	<b>914-.401-WP</b>	1	10	27	51	0.029	
		M	P	A	<b>934-.401-WP</b>	1	10	27	45	0.029			
					C + A	<b>934-.401-WP</b>	1	10	27	45	0.029		
		5 NC + 5 NO	MA	P	A	<b>925-.401-WP</b>	1	10	27	48	0.032		
						C + A	<b>915-.401-WP</b>	1	10	27	48	0.032	
		M	P	A	<b>935-.401-WP</b>	1	10	27	42	0.032			
					C + A	<b>935-.401-WP</b>	1	10	27	42	0.032		
		55 mm		1 NC + 1 NO	MA	S1	A	<b>921-.401-W0</b>		10	20	52	0.024
								C + A	<b>911-.401-W0</b>		10	20	52
				M	S1	A	<b>931-.401-W0</b>		10	20	46	0.024	
							C + A	<b>931-.401-W0</b>		10	20	46	0.024
2 NC + 2 NO	MA			S1	A	<b>922-.401-W0</b>		10	20	49	0.025		
						C + A	<b>912-.401-W0</b>		10	20	49	0.025	
M	S1			A	<b>932-.401-W0</b>		10	20	43	0.025			
					C + A	<b>932-.401-W0</b>		10	20	43	0.025		
3 NC + 3 NO	MA			S1	A	<b>923-.401-W0</b>		10	20	50	0.027		
						C + A	<b>913-.401-W0</b>		10	20	50	0.027	
M	S1			A	<b>933-.401-W0</b>		10	20	44	0.027			
					C + A	<b>933-.401-W0</b>		10	20	44	0.027		
4 NC + 4 NO	MA	S1	A	<b>924-.401-W0</b>		10	20	51	0.030				
				C + A	<b>914-.401-W0</b>		10	20	51	0.030			
M	S1	A	<b>934-.401-W0</b>		10	20	45	0.030					
			C + A	<b>934-.401-W0</b>		10	20	45	0.030				
5 NC + 5 NO	MA	S1	A	<b>925-.401-W0</b>		10	20	48	0.033				
				C + A	<b>915-.401-W0</b>		10	20	48	0.033			
M	S1	A	<b>935-.401-W0</b>		10	20	42	0.033					
			C + A	<b>935-.401-W0</b>		10	20	42	0.033				

Other key remove and key lock number on request

Hint:

We recommend to use location strip no. 260-0020-00 for anti-twisting of the front bezel.

At momentary position the overturning force is max. 60 Ncm

Contacts: NC = Normally closed, NO = Normally open

Switching action: MA = Maintained action, M = Momentary action

Terminals: P = PCB terminal, S1 = Soldering terminal (also pluggable 2.8 x 0.5 mm)

Component layout from page 83, Mounting dimensions from page 84, Technical drawing from page 88, Circuit drawing from page 99

## Keylock switch actuator 2 positions 70 mm

Actuators usable for front dimensions:  $\square$  24 x 24 mm |  $\square$  18 x 18 mm |  $\square$  18 x 24 mm | 24 mm dia. | 18 mm dia.



### Essential Accessories:

Front bezel for Keylock switch and Selector switch 2 positions page 58

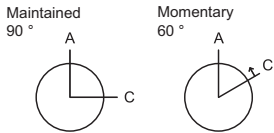

	Front protection	Mounting depth	Contacts	Switching action	Terminals	Key remove	Typ-Nr.	Component layout		Technical drawing	Circuit drawing	
								Mounting dimensions				
<b>Keylock switch actuator 2 positions 70 mm</b> Standard lock B2 300	IP 40	67 mm	1 NC + 1 NO	MA	P	A	<b>821-.401-0P</b>	1	9	53	52	0.026
							C + A	<b>811-.401-0P</b>	1	9	53	52
			M	P	A	<b>831-.401-0P</b>	1	9	53	46	0.026	
						C + A	<b>812-.401-0P</b>	1	9	53	49	0.027
			2 NC + 2 NO	MA	P	A	<b>822-.401-0P</b>	1	9	53	49	0.027
							C + A	<b>812-.401-0P</b>	1	9	53	49
			M	P	A	<b>832-.401-0P</b>	1	9	53	43	0.027	
						C + A	<b>813-.401-0P</b>	1	9	53	50	0.028
			3 NC + 3 NO	MA	P	A	<b>823-.401-0P</b>	1	9	53	50	0.028
							C + A	<b>813-.401-0P</b>	1	9	53	50
			M	P	A	<b>833-.401-0P</b>	1	9	53	44	0.028	
						C + A	<b>814-.401-0P</b>	1	9	53	51	0.031
		4 NC + 4 NO	MA	P	A	<b>824-.401-0P</b>	1	9	53	51	0.031	
						C + A	<b>814-.401-0P</b>	1	9	53	51	0.031
		M	P	A	<b>834-.401-0P</b>	1	9	53	45	0.031		
					C + A	<b>815-.401-0P</b>	1	9	53	48	0.034	
		5 NC + 5 NO	MA	P	A	<b>825-.401-0P</b>	1	9	53	48	0.034	
						C + A	<b>815-.401-0P</b>	1	9	53	48	0.034
		M	P	A	<b>835-.401-0P</b>	1	9	53	42	0.034		
					C + A	<b>815-.401-0P</b>	1	9	53	48	0.034	
		70 mm	1 NC + 1 NO	MA	S1	A	<b>821-.401-00</b>		9	52	52	0.026
							C + A	<b>811-.401-00</b>		9	52	52
			M	S1	A	<b>831-.401-00</b>		9	52	46	0.026	
						C + A	<b>812-.401-00</b>		9	52	49	0.027
2 NC + 2 NO	MA		S1	A	<b>822-.401-00</b>		9	52	49	0.027		
					C + A	<b>812-.401-00</b>		9	52	49	0.027	
M	S1		A	<b>832-.401-00</b>		9	52	43	0.027			
				C + A	<b>813-.401-00</b>		9	52	50	0.029		
3 NC + 3 NO	MA		S1	A	<b>823-.401-00</b>		9	52	50	0.029		
					C + A	<b>813-.401-00</b>		9	52	50	0.029	
M	S1		A	<b>833-.401-00</b>		9	52	44	0.029			
				C + A	<b>814-.401-00</b>		9	52	51	0.032		
4 NC + 4 NO	MA	S1	A	<b>824-.401-00</b>		9	52	51	0.032			
				C + A	<b>814-.401-00</b>		9	52	51	0.032		
M	S1	A	<b>834-.401-00</b>		9	52	45	0.032				
			C + A	<b>815-.401-00</b>		9	52	48	0.035			
5 NC + 5 NO	MA	S1	A	<b>825-.401-00</b>		9	52	48	0.035			
				C + A	<b>815-.401-00</b>		9	52	48	0.035		
M	S1	A	<b>835-.401-00</b>		9	52	42	0.035				
			C + A	<b>815-.401-00</b>		9	52	48	0.035			

Continuation see next page

Continued from previous page

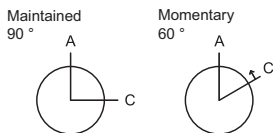

	Front protection	Mounting depth	Contacts	Switching action	Terminals	Key remove	Typ-Nr.	Component layout	Mounting dimensions	Technical drawing	Circuit drawing	
<b>Keylock switch actuator 2 positions 70 mm</b> Standard lock B2 300	IP 65	67 mm	1 NC + 1 NO	MA	P	A	<b>821-.401-WP</b>	1	10	53	52	0.026
							C + A	<b>811-.401-WP</b>	1	10	53	52
			M	P	A	<b>831-.401-WP</b>	1	10	53	46	0.026	
						C + A	<b>822-.401-WP</b>	1	10	53	49	0.027
			2 NC + 2 NO	MA	P	A	<b>822-.401-WP</b>	1	10	53	49	0.027
							C + A	<b>812-.401-WP</b>	1	10	53	49
			M	P	A	<b>832-.401-WP</b>	1	10	53	43	0.027	
						C + A	<b>823-.401-WP</b>	1	10	53	50	0.028
			3 NC + 3 NO	MA	P	A	<b>823-.401-WP</b>	1	10	53	50	0.028
							C + A	<b>813-.401-WP</b>	1	10	53	50
			M	P	A	<b>833-.401-WP</b>	1	10	53	44	0.028	
						C + A	<b>824-.401-WP</b>	1	10	53	51	0.031
			4 NC + 4 NO	MA	P	A	<b>824-.401-WP</b>	1	10	53	51	0.031
							C + A	<b>814-.401-WP</b>	1	10	53	51
		M	P	A	<b>834-.401-WP</b>	1	10	53	45	0.031		
					C + A	<b>825-.401-WP</b>	1	10	53	48	0.034	
		5 NC + 5 NO	MA	P	A	<b>825-.401-WP</b>	1	10	53	48	0.034	
						C + A	<b>815-.401-WP</b>	1	10	53	48	0.034
		M	P	A	<b>835-.401-WP</b>	1	10	53	42	0.034		
					C + A	<b>821-.401-WO</b>		10	52	52	0.026	
		70 mm	1 NC + 1 NO	MA	S1	A	<b>821-.401-WO</b>		10	52	52	0.026
							C + A	<b>811-.401-WO</b>		10	52	52
		M	S1	A	<b>831-.401-WO</b>		10	52	46	0.026		
					C + A	<b>822-.401-WO</b>		10	52	49	0.027	
		2 NC + 2 NO	MA	S1	A	<b>822-.401-WO</b>		10	52	49	0.027	
						C + A	<b>812-.401-WO</b>		10	52	49	0.027
		M	S1	A	<b>832-.401-WO</b>		10	52	43	0.027		
					C + A	<b>823-.401-WO</b>		10	52	50	0.029	
3 NC + 3 NO	MA	S1	A	<b>823-.401-WO</b>		10	52	50	0.029			
				C + A	<b>813-.401-WO</b>		10	52	50	0.029		
M	S1	A	<b>833-.401-WO</b>		10	52	44	0.029				
			C + A	<b>824-.401-WO</b>		10	52	51	0.032			
4 NC + 4 NO	MA	S1	A	<b>824-.401-WO</b>		10	52	51	0.032			
				C + A	<b>814-.401-WO</b>		10	52	51	0.032		
M	S1	A	<b>834-.401-WO</b>		10	52	45	0.032				
			C + A	<b>825-.401-WO</b>		10	52	48	0.035			
5 NC + 5 NO	MA	S1	A	<b>825-.401-WO</b>		10	52	48	0.035			
				C + A	<b>815-.401-WO</b>		10	52	48	0.035		
M	S1	A	<b>835-.401-WO</b>		10	52	42	0.035				
			C + A	<b>815-.401-WO</b>		10	52	48	0.035			

Other key remove and key lock number on request

Hint:

We recommend to use location strip no. 260-0020-00 for anti-twisting of the front bezel.

At momentary position the overturning force is max. 60 Ncm

Contacts: NC = Normally closed, NO = Normally open

Switching action: MA = Maintained action, M = Momentary action

Terminals: P = PCB terminal, S1 = Soldering terminal (also pluggable 2.8 x 0.5 mm)

Component layout from page 83, Mounting dimensions from page 84, Technical drawing from page 88, Circuit drawing from page 99

## Keylock switch actuator 3 positions 45 mm

Actuators usable for front dimensions:  $\square$  24 x 24 mm |  $\square$  18 x 18 mm |  $\square$  18 x 24 mm | 24 mm dia. | 18 mm dia.



### Essential Accessories:

Front bezel for Keylock switch and Selector switch 3 positions page 59

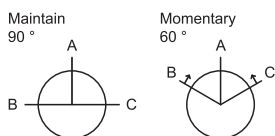

	Front protection	Mounting depth	Contacts	Switching action	Terminals	Key remove	Typ-Nr.	Component layout	Mounting dimensions	Technical drawing	Circuit drawing	
<b>Keylock switch actuator 3 positions 45 mm</b> Standard lock B2 300	IP 40	42 mm	2 NC + 2 NO	0-MA-MA	P	B + A + C	<b>722-.401-0P</b>	1	9	29	40	0.023
				MA-0-MA	P	B + A + C	<b>712-.401-0P</b>	1	9	29	40	0.023
				MA-0-M	P	B + A	<b>742-.401-0P</b>	1	9	29	39	0.023
				M-0-MA	P	C + A	<b>752-.401-0P</b>	1	9	29	38	0.023
		M-0-M	P	A	<b>732-.401-0P</b>	1	9	29	37	0.023		
		45 mm	2 NC + 2 NO	0-MA-MA	S1	B + A + C	<b>722-.401-00</b>		9	22	40	0.023
				MA-0-MA	S1	B + A + C	<b>712-.401-00</b>		9	22	40	0.023
				MA-0-M	S1	B + A	<b>742-.401-00</b>		9	22	39	0.023
	M-0-MA			S1	C + A	<b>752-.401-00</b>		9	22	38	0.023	
	M-0-M	S1	A	<b>732-.401-00</b>		9	22	37	0.023			
	IP 65	42 mm	2 NC + 2 NO	0-MA-MA	P	B + A + C	<b>722-.401-WP</b>	1	10	29	40	0.023
				MA-0-MA	P	B + A + C	<b>712-.401-WP</b>	1	10	29	40	0.023
				MA-0-M	P	B + A	<b>742-.401-WP</b>	1	10	29	39	0.023
				M-0-MA	P	C + A	<b>752-.401-WP</b>	1	10	29	38	0.023
		M-0-M	P	A	<b>732-.401-WP</b>	1	10	29	37	0.023		
		45 mm	2 NC + 2 NO	0-MA-MA	S1	B + A + C	<b>722-.401-W0</b>		10	22	40	0.023
MA-0-MA				S1	B + A + C	<b>712-.401-W0</b>		10	22	40	0.023	
MA-0-M				S1	B + A	<b>742-.401-W0</b>		10	22	39	0.023	
M-0-MA	S1			C + A	<b>752-.401-W0</b>		10	22	38	0.023		
M-0-M	S1	A	<b>732-.401-W0</b>		10	22	37	0.023				

Other key remove and key lock number on request

Hint:

We recommend to use location strip no. 260-0020-00 for anti-twisting of the front bezel.

At momentary position the overturning force is max. 60 Ncm

Contacts: NC = Normally closed, NO = Normally open

Switching action: MA = Maintained action, M = Momentary action

Terminals: P = PCB terminal, S1 = Soldering terminal (also pluggable 2.8 x 0.5 mm)

Component layout from page 83, Mounting dimensions from page 84, Technical drawing from page 88, Circuit drawing from page 99





## Selector switch actuator 2 positions 45 mm

Actuators usable for front dimensions:  $\varnothing$  24 x 24 mm |  $\varnothing$  18 x 18 mm |  $\square$  18 x 24 mm | 24 mm dia. | 18 mm dia.



### Essential Accessories:

-  Front bezel for Keylock switch and Selector switch 2 positions page 58
-  Lever page 60

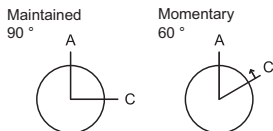

	Front protection	Mounting depth	Contacts	Switching action	Terminals	Typ-Nr.	Component layout	Mounting dimensions	Technical drawing	Circuit drawing	
<b>Selector switch actuator 2 positions 45 mm</b>	IP 40	42 mm	1 NC + 1 NO	MA	P	<b>761-.700-0P</b>	1	1	30	26	0.011
				M	P	<b>781-.700-0P</b>	1	1	30	20	0.011
		45 mm	1 NC + 1 NO	MA	S1	<b>761-.700-00</b>		1	23	26	0.011
				M	S1	<b>781-.700-00</b>		1	23	20	0.011
		45 mm	2 NC + 2 NO	MA	S1	<b>762-.700-00</b>		1	23	28	0.012
				M	S1	<b>782-.700-00</b>		1	23	22	0.012
	IP 65	42 mm	1 NC + 1 NO	MA	P	<b>761-.700-WP</b>	1	2	30	26	0.011
				M	P	<b>781-.700-WP</b>	1	2	30	20	0.011
		45 mm	1 NC + 1 NO	MA	S1	<b>761-.700-W0</b>		2	23	26	0.011
				M	S1	<b>781-.700-W0</b>		2	23	20	0.011
		45 mm	2 NC + 2 NO	MA	S1	<b>762-.700-W0</b>		2	23	28	0.012
				M	S1	<b>782-.700-W0</b>		2	23	22	0.012

### Hint:

We recommend to use location strip no. 260-0020-00 for anti-twisting of the front bezel.

At momentary position the overturning force is max. 60 Ncm

Contacts: NC = Normally closed, NO = Normally open

Switching action: MA = Maintained action, M = Momentary action

Terminals: P = PCB terminal, S1 = Soldering terminal (also pluggable 2.8 x 0.5 mm)



Component layout from page 83, Mounting dimensions from page 84, Technical drawing from page 88, Circuit drawing from page 99

## Selector switch actuator 2 positions 55 mm

Actuators usable for front dimensions:  $\varnothing$  24 x 24 mm |  $\varnothing$  18 x 18 mm |  $\square$  18 x 24 mm | 24 mm dia. | 18 mm dia.



### Essential Accessories:

-  Front bezel for Keylock switch and Selector switch 2 positions page 58
-  Lever page 60

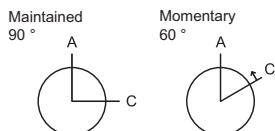

	Front protection	Mounting depth	Contacts	Switching action		Typ-Nr.	Component layout		Technical drawing	Circuit drawing	
				Terminals			Mounting dimensions				
<b>Selector switch actuator 2 positions 55 mm</b>	IP 40	52 mm	1 NC + 1 NO	MA	P	<b>911-.700-0P</b>	1	1	28	31	0.013
				M	P	<b>931-.700-0P</b>	1	1	28	25	0.013
			2 NC + 2 NO	MA	P	<b>912-.700-0P</b>	1	1	28	28	0.014
				M	P	<b>932-.700-0P</b>	1	1	28	22	0.014
			3 NC + 3 NO	MA	P	<b>913-.700-0P</b>	1	1	28	29	0.015
				M	P	<b>933-.700-0P</b>	1	1	28	23	0.015
			4 NC + 4 NO	MA	P	<b>914-.700-0P</b>	1	1	28	30	0.018
				M	P	<b>934-.700-0P</b>	1	1	28	24	0.018
			5 NC + 5 NO	MA	P	<b>915-.700-0P</b>	1	1	28	27	0.022
				M	P	<b>935-.700-0P</b>	1	1	28	21	0.022
		55 mm	1 NC + 1 NO	MA	S1	<b>911-.700-00</b>		1	21	31	0.013
				M	S1	<b>931-.700-00</b>		1	21	25	0.013
			2 NC + 2 NO	MA	S1	<b>912-.700-00</b>		1	21	28	0.014
				M	S1	<b>932-.700-00</b>		1	21	22	0.014
			3 NC + 3 NO	MA	S1	<b>913-.700-00</b>		1	21	29	0.015
				M	S1	<b>933-.700-00</b>		1	21	23	0.015
			4 NC + 4 NO	MA	S1	<b>914-.700-00</b>		1	21	30	0.019
				M	S1	<b>934-.700-00</b>		1	21	24	0.019
			5 NC + 5 NO	MA	S1	<b>915-.700-00</b>		1	21	27	0.023
				M	S1	<b>935-.700-00</b>		1	21	21	0.023

Continued from previous page

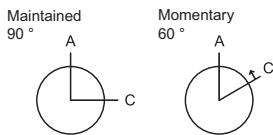

	Front protection	Mounting depth	Contacts	Switching action	Terminals	Typ-Nr.	Component layout	Mounting dimensions	Technical drawing	Circuit drawing	
<b>Selector switch actuator 2 positions 55 mm</b>	IP 65	52 mm	1 NC + 1 NO	MA	P	<b>911-.700-WP</b>	1	2	28	31	0.013
				M	P	<b>931-.700-WP</b>	1	2	28	25	0.013
			2 NC + 2 NO	MA	P	<b>912-.700-WP</b>	1	2	28	28	0.014
				M	P	<b>932-.700-WP</b>	1	2	28	22	0.014
			3 NC + 3 NO	MA	P	<b>913-.700-WP</b>	1	2	28	29	0.015
				M	P	<b>933-.700-WP</b>	1	2	28	23	0.015
			4 NC + 4 NO	MA	P	<b>914-.700-WP</b>	1	2	28	30	0.018
				M	P	<b>934-.700-WP</b>	1	2	28	24	0.018
			5 NC + 5 NO	MA	P	<b>915-.700-WP</b>	1	2	28	27	0.022
				M	P	<b>935-.700-WP</b>	1	2	28	21	0.022
		55 mm	1 NC + 1 NO	MA	S1	<b>911-.700-W0</b>		2	21	31	0.013
				M	S1	<b>931-.700-W0</b>		2	21	25	0.013
			2 NC + 2 NO	MA	S1	<b>912-.700-W0</b>		2	21	28	0.014
				M	S1	<b>932-.700-W0</b>		2	21	22	0.014
			3 NC + 3 NO	MA	S1	<b>913-.700-W0</b>		2	21	29	0.015
				M	S1	<b>933-.700-W0</b>		2	21	23	0.015
			4 NC + 4 NO	MA	S1	<b>914-.700-W0</b>		2	21	30	0.019
				M	S1	<b>934-.700-W0</b>		2	21	24	0.019
			5 NC + 5 NO	MA	S1	<b>915-.700-W0</b>		2	21	27	0.023
				M	S1	<b>935-.700-W0</b>		2	21	21	0.023

Hint:

We recommend to use location strip no. 260-0020-00 for anti-twisting of the front bezel.

At momentary position the overturning force is max. 60 Ncm

Contacts: NC = Normally closed, NO = Normally open

Switching action: MA = Maintained action, M = Momentary action

Terminals: P = PCB terminal, S1 = Soldering terminal (also pluggable 2.8 x 0.5 mm)



Component layout from page 83, Mounting dimensions from page 84, Technical drawing from page 88, Circuit drawing from page 99

## Selector switch actuator 2 positions 70 mm

Actuators usable for front dimensions:  $\varnothing$  24 x 24 mm |  $\varnothing$  18 x 18 mm |  $\varnothing$  18 x 24 mm | 24 mm dia. | 18 mm dia.



### Essential Accessories:

-  Front bezel for Keylock switch and Selector switch 2 positions page 58
-  Lever page 60

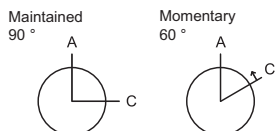

	Front protection	Mounting depth	Contacts	Switching action		Typ-Nr.	Component layout		Technical drawing	Circuit drawing	
				Terminals			Mounting dimensions				
<b>Selector switch actuator 2 positions 70 mm</b>	IP 40	67 mm	1 NC + 1 NO	MA	P	<b>811-.700-0P</b>	1	1	55	31	0.015
				M	P	<b>831-.700-0P</b>	1	1	55	25	0.015
			2 NC + 2 NO	MA	P	<b>812-.700-0P</b>	1	1	55	28	0.016
				M	P	<b>832-.700-0P</b>	1	1	55	22	0.016
			3 NC + 3 NO	MA	P	<b>813-.700-0P</b>	1	1	55	29	0.017
				M	P	<b>833-.700-0P</b>	1	1	55	23	0.017
		4 NC + 4 NO	MA	P	<b>814-.700-0P</b>	1	1	55	30	0.020	
			M	P	<b>834-.700-0P</b>	1	1	55	24	0.020	
		5 NC + 5 NO	MA	P	<b>815-.700-0P</b>	1	1	55	27	0.024	
			M	P	<b>835-.700-0P</b>	1	1	55	21	0.024	
		70 mm	1 NC + 1 NO	MA	S1	<b>811-.700-00</b>		1	54	31	0.015
				M	S1	<b>831-.700-00</b>		1	54	25	0.015
	2 NC + 2 NO		MA	S1	<b>812-.700-00</b>		1	54	28	0.016	
			M	S1	<b>832-.700-00</b>		1	54	22	0.016	
	3 NC + 3 NO		MA	S1	<b>813-.700-00</b>		1	54	29	0.017	
			M	S1	<b>833-.700-00</b>		1	54	23	0.017	
	4 NC + 4 NO	MA	S1	<b>814-.700-00</b>		1	54	30	0.021		
		M	S1	<b>834-.700-00</b>		1	54	24	0.021		
	5 NC + 5 NO	MA	S1	<b>815-.700-00</b>		1	54	27	0.025		
		M	S1	<b>835-.700-00</b>		1	54	21	0.025		

Continued from previous page

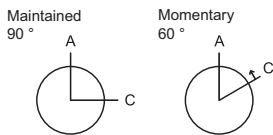

	Front protection	Mounting depth	Contacts	Switching action	Terminals	Typ-Nr.	Component layout	Mounting dimensions	Technical drawing	Circuit drawing	
<b>Selector switch actuator 2 positions 70 mm</b>	IP 65	67 mm	1 NC + 1 NO	MA	P	<b>811-.700-WP</b>	1	2	55	31	0.015
				M	P	<b>831-.700-WP</b>	1	2	55	25	0.015
			2 NC + 2 NO	MA	P	<b>812-.700-WP</b>	1	2	55	28	0.016
				M	P	<b>832-.700-WP</b>	1	2	55	22	0.016
			3 NC + 3 NO	MA	P	<b>813-.700-WP</b>	1	2	55	29	0.017
				M	P	<b>833-.700-WP</b>	1	2	55	23	0.017
			4 NC + 4 NO	MA	P	<b>814-.700-WP</b>	1	2	55	30	0.020
				M	P	<b>834-.700-WP</b>	1	2	55	24	0.020
			5 NC + 5 NO	MA	P	<b>815-.700-WP</b>	1	2	55	27	0.024
				M	P	<b>835-.700-WP</b>	1	2	55	21	0.024
		70 mm	1 NC + 1 NO	MA	S1	<b>811-.700-W0</b>		2	54	31	0.015
				M	S1	<b>831-.700-W0</b>		2	54	25	0.015
			2 NC + 2 NO	MA	S1	<b>812-.700-W0</b>		2	54	28	0.016
				M	S1	<b>832-.700-W0</b>		2	54	22	0.016
			3 NC + 3 NO	MA	S1	<b>813-.700-W0</b>		2	54	29	0.017
				M	S1	<b>833-.700-W0</b>		2	54	23	0.017
			4 NC + 4 NO	MA	S1	<b>814-.700-W0</b>		2	54	30	0.021
				M	S1	<b>834-.700-W0</b>		2	54	24	0.021
			5 NC + 5 NO	MA	S1	<b>815-.700-W0</b>		2	54	27	0.025
				M	S1	<b>835-.700-W0</b>		2	54	21	0.025

Hint:

We recommend to use location strip no. 260-0020-00 for anti-twisting of the front bezel.

At momentary position the overturning force is max. 60 Ncm

Contacts: NC = Normally closed, NO = Normally open

Switching action: MA = Maintained action, M = Momentary action

Terminals: P = PCB terminal, S1 = Soldering terminal (also pluggable 2.8 x 0.5 mm)

Component layout from page 83, Mounting dimensions from page 84, Technical drawing from page 88, Circuit drawing from page 99

## Selector switch actuator 3 positions 45 mm

Actuators usable for front dimensions:  $\square$  24 x 24 mm |  $\square$  18 x 18 mm |  $\square$  18 x 24 mm | 24 mm dia. | 18 mm dia.



### Essential Accessories:

- Front bezel for Keylock switch and Selector switch 3 positions page 59
- Lever page 60

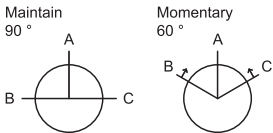

	Front protection	Mounting depth	Contacts	Switching action	Terminals	Typ-Nr.	Component layout	Mounting dimensions	Technical drawing	Circuit drawing	
<b>Selector switch actuator 3 positions 45 mm</b>	IP 40	42 mm	2 NC + 2 NO	0-MA-MA	P	<b>722-.700-0P</b>	1	1	30	19	0.012
				MA-0-MA	P	<b>712-.700-0P</b>	1	1	30	19	0.012
				MA-0-M	P	<b>742-.700-0P</b>	1	1	30	18	0.012
				M-0-MA	P	<b>752-.700-0P</b>	1	1	30	17	0.012
				M-0-M	P	<b>732-.700-0P</b>	1	1	30	16	0.012
		45 mm	2 NC + 2 NO	0-MA-MA	S1	<b>722-.700-00</b>		1	23	19	0.012
				MA-0-MA	S1	<b>712-.700-00</b>		1	23	19	0.012
				MA-0-M	S1	<b>742-.700-00</b>		1	23	18	0.012
				M-0-MA	S1	<b>752-.700-00</b>		1	23	17	0.012
				M-0-M	S1	<b>732-.700-00</b>		1	23	16	0.012
	IP 65	42 mm	2 NC + 2 NO	0-MA-MA	P	<b>722-.700-WP</b>	1	2	30	19	0.012
				MA-0-MA	P	<b>712-.700-WP</b>	1	2	30	19	0.012
				MA-0-M	P	<b>742-.700-WP</b>	1	2	30	18	0.012
				M-0-MA	P	<b>752-.700-WP</b>	1	2	30	17	0.012
				M-0-M	P	<b>732-.700-WP</b>	1	2	30	16	0.012
		45 mm	2 NC + 2 NO	0-MA-MA	S1	<b>722-.700-W0</b>		2	23	19	0.012
				MA-0-MA	S1	<b>712-.700-W0</b>		2	23	19	0.012
				MA-0-M	S1	<b>742-.700-W0</b>		2	23	18	0.012
				M-0-MA	S1	<b>752-.700-W0</b>		2	23	17	0.012
				M-0-M	S1	<b>732-.700-W0</b>		2	23	16	0.012

### Hint:

We recommend to use location strip no. 260-0020-00 for anti-twisting of the front bezel.

At momentary position the overturning force is max. 60 Ncm

Contacts: NC = Normally closed, NO = Normally open

Switching action: MA = Maintained action, M = Momentary action



Terminals: P = PCB terminal, S1 = Soldering terminal (also pluggable 2.8 x 0.5 mm)

Component layout from page 83, Mounting dimensions from page 84, Technical drawing from page 88, Circuit drawing from page 99

## Illuminated push-pull pushbutton actuator 45 mm



### Essential Accessories:

-  Push-pull knob page 61
-  Single-LED page 70

	Front protection	Mounting depth	Contacts	Switching action	Terminals	Front bezel	Ø 18 mm Typ-Nr.	Component layout	Mounting dimensions	Technical drawing	Circuit drawing	
<b>Illuminated push-pull pushbutton actuator 45 mm</b> Lampholder T1 <sup>3</sup> / <sub>4</sub> MG	IP 40	51 mm	2 NC + 2 NO	M-0-M	P	Plastic black	<b>792-2000-0P</b>	1	13	32	59	0.015
						Plastic grey	<b>792-1000-0P</b>	1	13	32	59	0.015
	IP 40	54 mm	2 NC + 2 NO	M-0-M	S1	Plastic black	<b>792-2000-00</b>		13	25	59	0.015
						Plastic grey	<b>792-1000-00</b>		13	25	59	0.015

Contacts: NC = Normally closed, NO = Normally open

Switching action: M = Momentary action

Terminals: P = PCB terminal, S1 = Soldering terminal (also pluggable 2.8 x 0.5 mm)

Component layout from page 83, Mounting dimensions from page 84, Technical drawing from page 88, Circuit drawing from page 99

## Illuminated pushbutton actuator 55 - 70 mm, momentary, switch interlock system variants 1, 3 - 7

Protection degree IP 40/IP 65 is determined by front bezel and lens

Actuators usable for front dimensions: □ 24 x 24 mm | □ 18 x 18 mm | □ 18 x 24 mm | 24 mm dia. | 18 mm dia.



### Essential Accessories:

- ☞ Front bezel for buttons 30 - 70 mm and 55 - 70 mm page 61
- ☞ Lens plastic for buttons 30 - 70 mm and 55 - 70 mm page 55
- ☞ Single-LED page 70

	Mounting depth	Contacts	Switching action	Terminals	Typ-Nr.	Component layout	Mounting dimensions	Technical drawing	Circuit drawing	
Illuminated pushbutton actuator 55 - 70 mm, momentary, switch interlock system variants 1, 3 - 7 Lampholder T1 3/4 MG	52 mm	1 NC + 1 NO	M	P	<b>981-.000-0P</b>	1	7 8	60	0.013	(E-3)
		2 NC + 2 NO	M	P	<b>982-.000-0P</b>	1	7 8	61	0.014	
		3 NC + 3 NO	M	P	<b>983-.000-0P</b>	1	7 8	62	0.014	
		4 NC + 4 NO	M	P	<b>984-.000-0P</b>	1	7 8	63	0.018	
		5 NC + 5 NO	M	P	<b>985-.000-0P</b>	1	7 8	64	0.021	
	55 mm	1 NC + 1 NO	M	S1	<b>981-.000-00</b>		7 4	60	0.013	
		2 NC + 2 NO	M	S1	<b>982-.000-00</b>		7 4	61	0.014	
		3 NC + 3 NO	M	S1	<b>983-.000-00</b>		7 4	62	0.015	
		4 NC + 4 NO	M	S1	<b>984-.000-00</b>		7 4	63	0.019	
		5 NC + 5 NO	M	S1	<b>985-.000-00</b>		7 4	64	0.022	
Lampholder T5.5	67 mm	1 NC + 1 NO	M	P	<b>881-.000-0P</b>	1	7 12	60	0.015	
		2 NC + 2 NO	M	P	<b>882-.000-0P</b>	1	7 12	61	0.016	
		3 NC + 3 NO	M	P	<b>883-.000-0P</b>	1	7 12	62	0.017	
		4 NC + 4 NO	M	P	<b>884-.000-0P</b>	1	7 12	63	0.020	
		5 NC + 5 NO	M	P	<b>885-.000-0P</b>	1	7 12	64	0.023	
	70 mm	1 NC + 1 NO	M	S1	<b>881-.000-00</b>		7 11	60	0.015	
		2 NC + 2 NO	M	S1	<b>882-.000-00</b>		7 11	61	0.016	
		3 NC + 3 NO	M	S1	<b>883-.000-00</b>		7 11	62	0.017	
		4 NC + 4 NO	M	S1	<b>884-.000-00</b>		7 11	63	0.021	
		5 NC + 5 NO	M	S1	<b>885-.000-00</b>		7 11	64	0.024	

Functions see part 'Switch interlock system'

Contacts: NC = Normally closed, NO = Normally open

Switching action: M = Momentary action

Terminals: P = PCB terminal, S1 = Soldering terminal (also pluggable 2.8 x 0.5 mm)

Component layout from page 83, Mounting dimensions from page 84, Technical drawing from page 88, Circuit drawing from page 99



## Illuminated pushbutton actuator 55 - 70 mm, maintained, switch interlock system variant 2

Protection degree IP 40/IP 65 is determined by front bezel and lens

Actuators usable for front dimensions: □ 24 x 24 mm | □ 18 x 18 mm | □ 18 x 24 mm | 24 mm dia. | 18 mm dia.



### Essential Accessories:

- 🛒 Front bezel for buttons 30 - 70 mm and 55 - 70 mm page 61
- 🛒 Lens plastic for buttons 30 - 70 mm and 55 - 70 mm page 55
- 🛒 Single-LED page 70

	Mounting depth	Contacts	Switching action	Terminals	Typ-Nr.	Component layout				Technical drawing	Circuit drawing
						Mounting dimensions	Mounting dimensions	Mounting dimensions	Mounting dimensions		
<b>Illuminated pushbutton actuator 55 - 70 mm, maintained, switch interlock system variant 2</b> Lampholder T1 <sup>3</sup> / <sub>4</sub> MG	52 mm	1 NC + 1 NO	R (Ir)	P	<b>901-.000-0P</b>	1	7	8	14	0.013	
		2 NC + 2 NO	R (Ir)	P	<b>902-.000-0P</b>	1	7	8	8	0.014	
		3 NC + 3 NO	R (Ir)	P	<b>903-.000-0P</b>	1	7	8	12	0.014	
		4 NC + 4 NO	R (Ir)	P	<b>904-.000-0P</b>	1	7	8	11	0.018	
		5 NC + 5 NO	R (Ir)	P	<b>905-.000-0P</b>	1	7	8	6	0.021	
	55 mm	1 NC + 1 NO	R (Ir)	S1	<b>901-.000-00</b>		7	4	14	0.013	
		2 NC + 2 NO	R (Ir)	S1	<b>902-.000-00</b>		7	4	8	0.014	
		3 NC + 3 NO	R (Ir)	S1	<b>903-.000-00</b>		7	4	12	0.015	
		4 NC + 4 NO	R (Ir)	S1	<b>904-.000-00</b>		7	4	11	0.019	
		5 NC + 5 NO	R (Ir)	S1	<b>905-.000-00</b>		7	4	6	0.022	
Lampholder T5.5	67 mm	1 NC + 1 NO	R (Ir)	P	<b>801-.000-0P</b>	1	7	12	14	0.015	
		2 NC + 2 NO	R (Ir)	P	<b>802-.000-0P</b>	1	7	12	8	0.016	
		3 NC + 3 NO	R (Ir)	P	<b>803-.000-0P</b>	1	7	12	12	0.017	
		4 NC + 4 NO	R (Ir)	P	<b>804-.000-0P</b>	1	7	12	11	0.020	
		5 NC + 5 NO	R (Ir)	P	<b>805-.000-0P</b>	1	7	12	6	0.023	
	70 mm	1 NC + 1 NO	R (Ir)	S1	<b>801-.000-00</b>		7	11	14	0.015	
		2 NC + 2 NO	R (Ir)	S1	<b>802-.000-00</b>		7	11	8	0.016	
		3 NC + 3 NO	R (Ir)	S1	<b>803-.000-00</b>		7	11	12	0.017	
		4 NC + 4 NO	R (Ir)	S1	<b>804-.000-00</b>		7	11	11	0.021	
		5 NC + 5 NO	R (Ir)	S1	<b>805-.000-00</b>		7	11	6	0.024	

Functions see part 'Switch interlock system'

Contacts: NC = Normally closed, NO = Normally open

Switching action: R (Ir) = Maintained action (switchable to momentary action)

Terminals: P = PCB terminal, S1 = Soldering terminal (also pluggable 2.8 x 0.5 mm)

Component layout from page 83, Mounting dimensions from page 84, Technical drawing from page 88, Circuit drawing from page 99

## Release button actuator 55 - 70 mm, momentary, switch interlock system variants 4 - 7

Protection degree IP 40/IP 65 is determined by front bezel and lens

Actuators usable for front dimensions: □ 24 x 24 mm | □ 18 x 18 mm | □ 18 x 24 mm | 24 mm dia. | 18 mm dia.



### Essential Accessories:

- ☞ Front bezel for buttons 30 - 70 mm and 55 - 70 mm page 61
- ☞ Lens plastic for buttons 30 - 70 mm and 55 - 70 mm page 55
- ☞ Single-LED page 70

	Mounting depth	Contacts	Switching action	Terminals	Typ-Nr.	Component layout		Technical drawing	Circuit drawing	Eco	
						Mounting dimensions					
<b>Release button actuator 55 - 70 mm, momentary, switch interlock system variants 4 - 7</b> Lampholder T1 3/4 MG	52 mm	0 NC + 0 NO	M	P	<b>940-.000-0P</b>	1	7 8			0.012	
		1 NC + 1 NO	M	P	<b>941-.000-0P</b>	1	7 8	60	0.013		
		2 NC + 2 NO	M	P	<b>942-.000-0P</b>	1	7 8	61	0.014		
		3 NC + 3 NO	M	P	<b>943-.000-0P</b>	1	7 8	62	0.014		
		4 NC + 4 NO	M	P	<b>944-.000-0P</b>	1	7 8	63	0.018		
	5 NC + 5 NO	M	P	<b>945-.000-0P</b>	1	7 8	64	0.021			
	55 mm	0 NC + 0 NO	M	S1	<b>940-.000-00</b>		7 4			0.012	
		1 NC + 1 NO	M	S1	<b>941-.000-00</b>		7 4	60	0.013		
		2 NC + 2 NO	M	S1	<b>942-.000-00</b>		7 4	61	0.014		
		3 NC + 3 NO	M	S1	<b>943-.000-00</b>		7 4	62	0.015		
		4 NC + 4 NO	M	S1	<b>944-.000-00</b>		7 4	63	0.019		
	5 NC + 5 NO	M	S1	<b>945-.000-00</b>		7 4	64	0.022			
	Lampholder T5.5	67 mm	0 NC + 0 NO	M	P	<b>840-.000-0P</b>	1	7 12			0.014
			1 NC + 1 NO	M	P	<b>841-.000-0P</b>	1	7 12	60	0.015	
			2 NC + 2 NO	M	P	<b>842-.000-0P</b>	1	7 12	61	0.016	
3 NC + 3 NO			M	P	<b>843-.000-0P</b>	1	7 12	62	0.017		
4 NC + 4 NO			M	P	<b>844-.000-0P</b>	1	7 12	63	0.020		
5 NC + 5 NO		M	P	<b>845-.000-0P</b>	1	7 12	64	0.023			
70 mm		0 NC + 0 NO	M	S1	<b>840-.000-00</b>		7 11			0.014	
		1 NC + 1 NO	M	S1	<b>841-.000-00</b>		7 11	60	0.015		
		2 NC + 2 NO	M	S1	<b>842-.000-00</b>		7 11	61	0.016		
		3 NC + 3 NO	M	S1	<b>843-.000-00</b>		7 11	62	0.017		
		4 NC + 4 NO	M	S1	<b>844-.000-00</b>		7 11	63	0.021		
5 NC + 5 NO		M	S1	<b>845-.000-00</b>		7 11	64	0.024			

Functions see part 'Switch interlock system'

Contacts: NC = Normally closed, NO = Normally open

Switching action: M = Momentary action

Terminals: P = PCB terminal, S1 = Soldering terminal (also pluggable 2.8 x 0.5 mm)

Component layout from page 83, Mounting dimensions from page 84, Technical drawing from page 88, Circuit drawing from page 99

## Keylock switch 2 positions actuator 55 - 70 mm, momentary, switch interlock system function 2

Actuators usable for front dimensions:  $\varnothing$  24 x 24 mm |  $\varnothing$  18 x 18 mm |  $\varnothing$  18 x 24 mm | 24 mm dia. | 18 mm dia.



### Essential Accessories:

Front bezel for Keylock switch and Selector switch 2 positions page 58

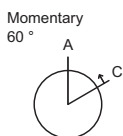

	Front protection	Mounting depth	Contacts	Terminals	Switching action	Key remove	Typ-Nr.	Component layout	Mounting dimensions	Technical drawing	Circuit drawing	
<b>Keylock switch 2 positions actuator 55 - 70 mm, momentary, switch interlock system function 2</b> Standard lock B2 300	IP 40	52 mm	1 NC + 1 NO	P	M	A	<b>931-.401-0P</b>	1	9	27	46	0.024
			2 NC + 2 NO	P	M	A	<b>932-.401-0P</b>	1	9	27	43	0.025
			3 NC + 3 NO	P	M	A	<b>933-.401-0P</b>	1	9	27	44	0.026
			4 NC + 4 NO	P	M	A	<b>934-.401-0P</b>	1	9	27	45	0.029
			5 NC + 5 NO	P	M	A	<b>935-.401-0P</b>	1	9	27	42	0.032
		55 mm	1 NC + 1 NO	S1	M	A	<b>931-.401-00</b>		9	20	46	0.024
			2 NC + 2 NO	S1	M	A	<b>932-.401-00</b>		9	20	43	0.025
			3 NC + 3 NO	S1	M	A	<b>933-.401-00</b>		9	20	44	0.027
			4 NC + 4 NO	S1	M	A	<b>934-.401-00</b>		9	20	45	0.030
			5 NC + 5 NO	S1	M	A	<b>935-.401-00</b>		9	20	42	0.033
		67 mm	1 NC + 1 NO	P	M	A	<b>831-.401-0P</b>	1	9	53	46	0.026
			2 NC + 2 NO	P	M	A	<b>832-.401-0P</b>	1	9	53	43	0.027
			3 NC + 3 NO	P	M	A	<b>833-.401-0P</b>	1	9	53	44	0.028
			4 NC + 4 NO	P	M	A	<b>834-.401-0P</b>	1	9	53	45	0.031
			5 NC + 5 NO	P	M	A	<b>835-.401-0P</b>	1	9	53	42	0.034
		70 mm	1 NC + 1 NO	S1	M	A	<b>831-.401-00</b>		9	52	46	0.026
			2 NC + 2 NO	S1	M	A	<b>832-.401-00</b>		9	52	43	0.027
			3 NC + 3 NO	S1	M	A	<b>833-.401-00</b>		9	52	44	0.029
			4 NC + 4 NO	S1	M	A	<b>834-.401-00</b>		9	52	45	0.032
			5 NC + 5 NO	S1	M	A	<b>835-.401-00</b>		9	52	42	0.035
IP 65	52 mm	1 NC + 1 NO	P	M	A	<b>931-.401-WP</b>	1	10	27	46	0.024	
		2 NC + 2 NO	P	M	A	<b>932-.401-WP</b>	1	10	27	43	0.025	
		3 NC + 3 NO	P	M	A	<b>933-.401-WP</b>	1	10	27	44	0.026	
		4 NC + 4 NO	P	M	A	<b>934-.401-WP</b>	1	10	27	45	0.029	
		5 NC + 5 NO	P	M	A	<b>935-.401-WP</b>	1	10	27	42	0.032	
	55 mm	1 NC + 1 NO	S1	M	A	<b>931-.401-W0</b>		10	20	46	0.024	
		2 NC + 2 NO	S1	M	A	<b>932-.401-W0</b>		10	20	43	0.025	
		3 NC + 3 NO	S1	M	A	<b>933-.401-W0</b>		10	20	44	0.027	
		4 NC + 4 NO	S1	M	A	<b>934-.401-W0</b>		10	20	45	0.030	
		5 NC + 5 NO	S1	M	A	<b>935-.401-W0</b>		10	20	42	0.033	
	67 mm	1 NC + 1 NO	P	M	A	<b>831-.401-WP</b>	1	10	53	46	0.026	
		2 NC + 2 NO	P	M	A	<b>832-.401-WP</b>	1	10	53	43	0.027	
		3 NC + 3 NO	P	M	A	<b>833-.401-WP</b>	1	10	53	44	0.028	
		4 NC + 4 NO	P	M	A	<b>834-.401-WP</b>	1	10	53	45	0.031	
		5 NC + 5 NO	P	M	A	<b>835-.401-WP</b>	1	10	53	42	0.034	
	70 mm	1 NC + 1 NO	S1	M	A	<b>831-.401-W0</b>		10	52	46	0.026	
		2 NC + 2 NO	S1	M	A	<b>832-.401-W0</b>		10	52	43	0.027	
		3 NC + 3 NO	S1	M	A	<b>833-.401-W0</b>		10	52	44	0.029	
		4 NC + 4 NO	S1	M	A	<b>834-.401-W0</b>		10	52	45	0.032	
		5 NC + 5 NO	S1	M	A	<b>835-.401-W0</b>		10	52	42	0.035	

Continuation see next page

Continued from previous page

Other key remove and key lock number on request

Hint:

We recommend to use location strip no. 260-0020-00 for anti-twisting of the front bezel.

At momentary position the overturning force is max. 60 Ncm

Functions see part 'Switch interlock system'

Contacts: NC = Normally closed, NO = Normally open

Terminals: P = PCB terminal, S1 = Soldering terminal (also pluggable 2.8 x 0.5 mm)

Switching action: M = Momentary action

Component layout from page 83, Mounting dimensions from page 84, Technical drawing from page 88, Circuit drawing from page 99

## Keylock switch actuator 2 positions 55 mm, maintained, switch interlock system functions 1 and 3

Actuators usable for front dimensions:  $\varnothing$  24 x 24 mm |  $\varnothing$  18 x 18 mm |  $\varnothing$  18 x 24 mm | 24 mm dia. | 18 mm dia.



### Essential Accessories:

Front bezel for Keylock switch and Selector switch 2 positions page 58

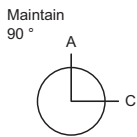

	Front protection	Mounting depth	Contacts	Switching action	Terminals	Key remove	Typ-Nr.	Component layout	Mounting dimensions	Technical drawing	Circuit drawing	
<b>Keylock switch actuator 2 positions 55 mm, maintained, switch interlock system functions 1 and 3</b> Standard lock B2 300	IP 40	52 mm	1 NC + 1 NO	MA	P	A	921-.401-0P	1	9	27	52	0.024
							C + A	911-.401-0P	1	9	27	52
			2 NC + 2 NO	MA	P	A	922-.401-0P	1	9	27	49	0.025
							C + A	912-.401-0P	1	9	27	49
			3 NC + 3 NO	MA	P	A	923-.401-0P	1	9	27	50	0.026
							C + A	913-.401-0P	1	9	27	50
			4 NC + 4 NO	MA	P	A	924-.401-0P	1	9	27	51	0.029
							C + A	914-.401-0P	1	9	27	51
			5 NC + 5 NO	MA	P	A	925-.401-0P	1	9	27	48	0.032
							C + A	915-.401-0P	1	9	27	48
		55 mm	1 NC + 1 NO	MA	S1	A	921-.401-00		9	20	52	0.024
							C + A	911-.401-00		9	20	52
			2 NC + 2 NO	MA	S1	A	922-.401-00		9	20	49	0.025
							C + A	912-.401-00		9	20	49
			3 NC + 3 NO	MA	S1	A	923-.401-00		9	20	50	0.027
	C + A						913-.401-00		9	20	50	0.027
	4 NC + 4 NO		MA	S1	A	924-.401-00		9	20	51	0.030	
						C + A	914-.401-00		9	20	51	0.030
	5 NC + 5 NO		MA	S1	A	925-.401-00		9	20	48	0.033	
						C + A	915-.401-00		9	20	48	0.033
	IP 65	52 mm	1 NC + 1 NO	MA	P	A	921-.401-WP	1	10	27	52	0.024
							C + A	911-.401-WP	1	10	27	52
			2 NC + 2 NO	MA	P	A	922-.401-WP	1	10	27	49	0.025
							C + A	912-.401-WP	1	10	27	49
			3 NC + 3 NO	MA	P	A	923-.401-WP	1	10	27	50	0.026
							C + A	913-.401-WP	1	10	27	50
			4 NC + 4 NO	MA	P	A	924-.401-WP	1	10	27	51	0.029
							C + A	914-.401-WP	1	10	27	51
			5 NC + 5 NO	MA	P	A	925-.401-WP	1	10	27	48	0.032
							C + A	915-.401-WP	1	10	27	48
55 mm		1 NC + 1 NO	MA	S1	A	921-.401-W0		10	20	52	0.024	
						C + A	911-.401-W0		10	20	52	0.024
		2 NC + 2 NO	MA	S1	A	922-.401-W0		10	20	49	0.025	
						C + A	912-.401-W0		10	20	49	0.025
		3 NC + 3 NO	MA	S1	A	923-.401-W0		10	20	50	0.027	
	C + A					913-.401-W0		10	20	50	0.027	
	4 NC + 4 NO	MA	S1	A	924-.401-W0		10	20	51	0.030		
					C + A	914-.401-W0		10	20	51	0.030	
	5 NC + 5 NO	MA	S1	A	925-.401-W0		10	20	48	0.033		
					C + A	915-.401-W0		10	20	48	0.033	

Continuation see next page

Continued from previous page

Other key remove and key lock number on request

Hint:

We recommend to use location strip no. 260-0020-00 for anti-twisting of the front bezel.

At momentary position the overturning force is max. 60 Ncm

Functions see part 'Switch interlock system'

Contacts: NC = Normally closed, NO = Normally open

Switching action: MA = Maintained action

Terminals: P = PCB terminal, S1 = Soldering terminal (also pluggable 2.8 x 0.5 mm)

Component layout from page 83, Mounting dimensions from page 84, Technical drawing from page 88, Circuit drawing from page 99

## Keylock switch 2 positions actuator 70 mm, maintained, switch interlock system functions 1 and 3

Actuators usable for front dimensions:  $\varnothing$  24 x 24 mm |  $\varnothing$  18 x 18 mm |  $\square$  18 x 24 mm | 24 mm dia. | 18 mm dia.



### Essential Accessories:

Front bezel for Keylock switch and Selector switch 2 positions page 58

Maintain  
90°

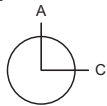

	Front protection	Mounting depth	Contacts	Switching action	Terminals	Key remove	Typ-Nr.	Component layout	Mounting dimensions	Technical drawing	Circuit drawing	
<b>Keylock switch 2 positions actuator 70 mm, maintained, switch interlock system functions 1 and 3</b> Standard lock B2 300	IP 40	67 mm	1 NC + 1 NO	MA	P	A	821-.401-0P	1	9	53	52	0.026
							C + A	811-.401-0P	1	9	53	52
			2 NC + 2 NO	MA	P	A	822-.401-0P	1	9	53	49	0.027
							C + A	812-.401-0P	1	9	53	49
			3 NC + 3 NO	MA	P	A	823-.401-0P	1	9	53	50	0.028
							C + A	813-.401-0P	1	9	53	50
			4 NC + 4 NO	MA	P	A	824-.401-0P	1	9	53	51	0.031
							C + A	814-.401-0P	1	9	53	51
			5 NC + 5 NO	MA	P	A	825-.401-0P	1	9	53	48	0.034
							C + A	815-.401-0P	1	9	53	48
		70 mm	1 NC + 1 NO	MA	S1	A	821-.401-00		9	52	52	0.026
							C + A	811-.401-00		9	52	52
			2 NC + 2 NO	MA	S1	A	822-.401-00		9	52	49	0.027
							C + A	812-.401-00		9	52	49
			3 NC + 3 NO	MA	S1	A	823-.401-00		9	52	50	0.029
	C + A						813-.401-00		9	52	50	0.029
	4 NC + 4 NO		MA	S1	A	824-.401-00		9	52	51	0.032	
						C + A	814-.401-00		9	52	51	0.032
	5 NC + 5 NO		MA	S1	A	825-.401-00		9	52	48	0.035	
						C + A	815-.401-00		9	52	48	0.035
	IP 65	67 mm	1 NC + 1 NO	MA	P	A	821-.401-WP	1	10	53	52	0.026
							C + A	811-.401-WP	1	10	53	52
			2 NC + 2 NO	MA	P	A	822-.401-WP	1	10	53	49	0.027
							C + A	812-.401-WP	1	10	53	49
			3 NC + 3 NO	MA	P	A	823-.401-WP	1	10	53	50	0.028
							C + A	813-.401-WP	1	10	53	50
			4 NC + 4 NO	MA	P	A	824-.401-WP	1	10	53	51	0.031
							C + A	814-.401-WP	1	10	53	51
			5 NC + 5 NO	MA	P	A	825-.401-WP	1	10	53	48	0.034
							C + A	815-.401-WP	1	10	53	48
70 mm		1 NC + 1 NO	MA	S1	A	821-.401-W0		10	52	52	0.026	
						C + A	811-.401-W0		10	52	52	0.026
		2 NC + 2 NO	MA	S1	A	822-.401-W0		10	52	49	0.027	
						C + A	812-.401-W0		10	52	49	0.027
		3 NC + 3 NO	MA	S1	A	823-.401-W0		10	52	50	0.029	
	C + A					813-.401-W0		10	52	50	0.029	
	4 NC + 4 NO	MA	S1	A	824-.401-W0		10	52	51	0.032		
					C + A	814-.401-W0		10	52	51	0.032	
	5 NC + 5 NO	MA	S1	A	825-.401-W0		10	52	48	0.035		
					C + A	815-.401-W0		10	52	48	0.035	

Continuation see next page

Continued from previous page

Other key remove and key lock number on request

Hint:

We recommend to use location strip no. 260-0020-00 for anti-twisting of the front bezel.

At momentary position the overturning force is max. 60 Ncm

Functions see part 'Switch interlock system'

Contacts: NC = Normally closed, NO = Normally open

Switching action: MA = Maintained action

Terminals: P = PCB terminal, S1 = Soldering terminal (also pluggable 2.8 x 0.5 mm)

Component layout from page 83, Mounting dimensions from page 84, Technical drawing from page 88, Circuit drawing from page 99



## Indicator actuator 35 mm, flush mounting



### Essential Accessories:

- Front bezel set, flush mounting page 62
- Lamp element block for 35 mm page 66
- Lens plastic for button 35 mm page 54
- Single-LED page 70

	Front protection	Ø 24 x 24 mm Typ-Nr.	Ø 24 x 30 mm Typ-Nr.	Ø 25 mm Typ-Nr.	Mounting dimensions	Technical drawing	Circuit drawing	
<b>Indicator actuator 35 mm, flush mounting</b>	IP 40	<b>690-4000-00</b>	<b>690-6000-00</b>	<b>690-2000-00</b>	4	41	2	0.004
Lampholder T1 <sup>3</sup> / <sub>4</sub> MG	IP 65	<b>690-4000-W0</b>	<b>690-6000-W0</b>	<b>690-2000-W0</b>	4	41	2	0.005

Mounting dimensions from page 84, Technical drawing from page 88, Circuit drawing from page 99

## Indicator actuator 30 - 70 mm, flush mounting

Actuators usable for front dimensions: Ø 24 x 24 mm | Ø 24 x 30 mm | 25 mm dia.



### Essential Accessories:

- Front bezel for buttons 30 - 70 mm and 55 - 70 mm page 61
- Front bezel set, flush mounting page 62
- Lens plastic for buttons 30 - 70 mm and 55 - 70 mm page 55
- Single-LED page 70

	Mounting depth	Terminals	Typ-Nr.	Component layout	Mounting dimensions	Technical drawing	Circuit drawing	
<b>Indicator actuator 30 - 70 mm, flush mounting</b>	39 mm	S1	<b>990-.000-K0</b>	4	46	2	0.004	
Lampholder T1 <sup>3</sup> / <sub>4</sub> MG	61 mm	P	<b>990-.000-0P</b>	1	4	48	2	0.007
	64 mm	S1	<b>990-.000-00</b>	4	47	2	0.007	
Lampholder T5.5	54 mm	S1	<b>890-.000-K0</b>	4	49	2	0.006	
	76 mm	P	<b>890-.000-0P</b>	1	4	51	2	0.010
	79 mm	S1	<b>890-.000-00</b>	4	50	2	0.010	



The indicators 55 mm and 70 mm are as long as the corresponding illuminated pushbuttons and fit to the PCB plug-in base and multi-plug housing  
 Terminals: S1 = Soldering terminal (also pluggable 2.8 x 0.5 mm), P = PCB terminal

Component layout from page 83, Mounting dimensions from page 84, Technical drawing from page 88, Circuit drawing from page 99

## Buzzer actuator 30 - 55 mm, flush mounting



### Essential Accessories:

-  Buzzer element page 60
-  Front bezel for Buzzer for 30- 55 mm page 62
-  Front bezel set Buzzer, flush mounting page 62

	Front protection	Mounting depth	Terminals	□ 24 x 30 mm Typ-Nr.	Mounting dimensions	Technical drawing	Circuit drawing	
<b>Buzzer actuator 30 - 55 mm, flush mounting</b> Buzzer socket T1 <sup>3</sup> / <sub>4</sub> MG	IP 40	39 mm	S1	<b>970-000-K0</b>	12	46	1	0.004
		61 mm	P	<b>970-000-0P</b>	12	48	1	0.007
		64 mm	S1	<b>970-000-00</b>	12	47	1	0.007

The buzzer 55 mm is as long as the corresponding illuminated pushbutton and fits to the PCB plug-in base and multi plug housing



Terminals: S1 = Soldering terminal (also pluggable 2.8 x 0.5 mm), P = PCB terminal

Mounting dimensions from page 84, Technical drawing from page 88, Circuit drawing from page 99

## Illuminated pushbutton actuator 35 mm, flush mounting



### Essential Accessories:

-  Lens plastic for button 35 mm page 54
-  Single-LED page 70
-  Snap-action switching element block for 35 mm page 66

	Front protection	Switching action	□ 24 x 24 mm Typ-Nr.	□ 24 x 30 mm Typ-Nr.	Ø 25 mm Typ-Nr.	Mounting dimensions	Technical drawing	Circuit drawing	
<b>Illuminated pushbutton actuator 35 mm, flush mounting</b> Lampholder T1 <sup>3</sup> / <sub>4</sub> MG	IP 40	R (Ir)	<b>600-4000-00</b>	<b>600-6000-00</b>	<b>600-2000-00</b>	4	41	15	0.004
		M	<b>680-4000-00</b>	<b>680-6000-00</b>	<b>680-2000-00</b>	4	41	32	0.004
	IP 65	R (Ir)	<b>600-4000-W0</b>	<b>680-6000-W0</b>	<b>600-2000-W0</b>	4	41	15	0.005
		M	<b>680-4000-W0</b>	<b>680-6000-W0</b>	<b>680-2000-W0</b>	4	41	32	0.005

Switching action: R (Ir) = Maintained action (switchable to momentary action), M = Momentary action





Mounting dimensions from page 84, Technical drawing from page 88, Circuit drawing from page 99

## Illuminated pushbutton actuator 55 - 70 mm, flush mounting

Actuators usable for front dimensions:  $\varnothing$  24 x 24 mm |  $\square$  24 x 30 mm | 25 mm dia.



### Essential Accessories:

-  Front bezel for buttons 30 - 70 mm and 55 - 70 mm page 61
-  Front bezel set, flush mounting page 62
-  Lens plastic for buttons 30 - 70 mm and 55 - 70 mm page 55
-  Single-LED page 70

	Front protection	Mounting depth	Switching action	Contacts	Terminals	Typ-Nr.	Component layout	Mounting dimensions	Technical drawing	Circuit drawing	
<b>Illuminated pushbutton actuator 55 - 70 mm, flush mounting</b> Lampholder T1 $\frac{3}{4}$ MG	IP 40	61 mm	R (Ir)	1 NC + 1 NO	P	<b>901-.000-0P</b>	1	4	43	14	0.013
				2 NC + 2 NO	P	<b>902-.000-0P</b>	1	4	43	8	0.014
				3 NC + 3 NO	P	<b>903-.000-0P</b>	1	4	43	12	0.014
				4 NC + 4 NO	P	<b>904-.000-0P</b>	1	4	43	11	0.018
				5 NC + 5 NO	P	<b>905-.000-0P</b>	1	4	43	6	0.021
	64 mm	R (Ir)	1 NC + 1 NO	S1	<b>901-.000-00</b>		4	42	14	0.013	
			2 NC + 2 NO	S1	<b>902-.000-00</b>		4	42	8	0.014	
			3 NC + 3 NO	S1	<b>903-.000-00</b>		4	42	12	0.015	
			4 NC + 4 NO	S1	<b>904-.000-00</b>		4	42	11	0.019	
			5 NC + 5 NO	S1	<b>905-.000-00</b>		4	42	6	0.022	
Lampholder T5.5	IP 40	76 mm	R (Ir)	1 NC + 1 NO	P	<b>801-.000-0P</b>	1	4	45	14	0.015
				2 NC + 2 NO	P	<b>802-.000-0P</b>	1	4	45	8	0.016
				3 NC + 3 NO	P	<b>803-.000-0P</b>	1	4	45	12	0.017
				4 NC + 4 NO	P	<b>804-.000-0P</b>	1	4	45	11	0.020
				5 NC + 5 NO	P	<b>805-.000-0P</b>	1	4	45	6	0.023
	79 mm	R (Ir)	1 NC + 1 NO	S1	<b>801-.000-00</b>		4	44	14	0.015	
			2 NC + 2 NO	S1	<b>802-.000-00</b>		4	44	8	0.016	
			3 NC + 3 NO	S1	<b>803-.000-00</b>		4	44	12	0.017	
			4 NC + 4 NO	S1	<b>804-.000-00</b>		4	44	11	0.021	
			5 NC + 5 NO	S1	<b>805-.000-00</b>		4	44	6	0.024	

Switching action: R (Ir) = Maintained action (switchable to momentary action)

Contacts: NC = Normally closed, NO = Normally open

Terminals: P = PCB terminal, S1 = Soldering terminal (also pluggable 2.8 x 0.5 mm)

Component layout from page 83, Mounting dimensions from page 84, Technical drawing from page 88, Circuit drawing from page 99

## Keylock switch actuator 2 positions 45 mm, flush mounting

Actuators usable for front dimensions:  $\square$  24 x 24 mm |  $\square$  24 x 30 mm | 25 mm dia.



### Essential Accessories:

Front bezel for Keylock switch and Selector switch 2 positions page 58

Front bezel set, flush mounting page 62

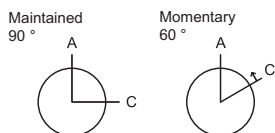

	Front protection	Mounting depth	Contacts	Switching action	Terminals	Key remove	Typ-Nr.	Component layout	Mounting dimensions	Technical drawing	Circuit drawing		
<b>Keylock switch actuator 2 positions 45 mm, flush mounting</b> Standard lock B2 300	IP 40	51 mm	1 NC + 1 NO	MA	P	A	<b>771-.401-0P</b>	1	4	57	47	0.022	
						C + A	<b>761-.401-0P</b>	1	4	57	47	0.022	
			M	P	A	<b>781-.401-0P</b>	1	4	57	41	0.022		
					C + A	<b>762-.401-0P</b>	1	4	57	49	0.023		
				2 NC + 2 NO	MA	P	A	<b>772-.401-0P</b>	1	4	57	49	0.023
							C + A	<b>762-.401-0P</b>	1	4	57	49	0.023
					M	P	A	<b>782-.401-0P</b>	1	4	57	43	0.023
				54 mm	1 NC + 1 NO	MA	S1	A	<b>771-.401-00</b>		4	56	47
							C + A	<b>761-.401-00</b>		4	56	47	0.022
					M	S1	A	<b>781-.401-00</b>		4	56	41	0.022
				2 NC + 2 NO	MA	S1	A	<b>772-.401-00</b>		4	56	49	0.023
							C + A	<b>762-.401-00</b>		4	56	49	0.023
					M	S1	A	<b>782-.401-00</b>		4	56	43	0.023
		IP 65	51 mm	1 NC + 1 NO	MA	P	A	<b>771-.401-WP</b>	1	4	57	47	0.022
						C + A	<b>761-.401-WP</b>	1	4	57	47	0.022	
					M	P	A	<b>781-.401-WP</b>	1	4	57	41	0.022
						C + A	<b>762-.401-WP</b>	1	4	57	49	0.023	
				2 NC + 2 NO	MA	P	A	<b>772-.401-WP</b>	1	4	57	49	0.023
							C + A	<b>762-.401-WP</b>	1	4	57	49	0.023
					M	P	A	<b>782-.401-WP</b>	1	4	57	43	0.023
			54 mm	1 NC + 1 NO	MA	S1	A	<b>771-.401-W0</b>		4	56	47	0.022
						C + A	<b>761-.401-W0</b>		4	56	47	0.022	
				M	S1	A	<b>781-.401-W0</b>		4	56	41	0.022	
			2 NC + 2 NO	MA	S1	A	<b>772-.401-W0</b>		4	56	49	0.023	
						C + A	<b>762-.401-W0</b>		4	56	49	0.023	
				M	S1	A	<b>782-.401-W0</b>		4	56	43	0.023	

Other key remove and key lock number on request

Hint:

We recommend to use location strip no. 260-0020-00 for anti-twisting of the front bezel.

At momentary position the overturning force is max. 60 Ncm

Contacts: NC = Normally closed, NO = Normally open

Switching action: MA = Maintained action, M = Momentary action

Terminals: P = PCB terminal, S1 = Soldering terminal (also pluggable 2.8 x 0.5 mm)



Component layout from page 83, Mounting dimensions from page 84, Technical drawing from page 88, Circuit drawing from page 99

## Keylock switch actuator 2 positions 55 mm, flush mounting

Actuators usable for front dimensions:  $\varnothing 24 \times 24 \text{ mm}$  |  $\varnothing 24 \times 30 \text{ mm}$  | 25 mm dia.



### Essential Accessories:

-  Front bezel for Keylock switch and Selector switch 2 positions page 58
-  Front bezel set, flush mounting page 62

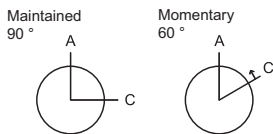

	Front protection	Mounting depth	Contacts	Switching action	Terminals	Key remove	Typ-Nr.	Component layout				Circuit drawing	
								Mounting dimensions	Technical drawing				
<b>Keylock switch actuator 2 positions 55 mm, flush mounting</b> Standard lock B2 300	IP 40	61 mm	1 NC + 1 NO	MA	P	A	<b>921-.401-0P</b>	1	4	59	52	0.024	
							C + A	<b>911-.401-0P</b>	1	4	59	52	0.024
			M	P	A	<b>931-.401-0P</b>	1	4	59	46	0.024		
						C + A	<b>912-.401-0P</b>	1	4	59	49	0.025	
			2 NC + 2 NO	MA	P	A	<b>922-.401-0P</b>	1	4	59	49	0.025	
							C + A	<b>912-.401-0P</b>	1	4	59	49	0.025
			M	P	A	<b>932-.401-0P</b>	1	4	59	43	0.025		
						C + A	<b>913-.401-0P</b>	1	4	59	50	0.026	
			3 NC + 3 NO	MA	P	A	<b>923-.401-0P</b>	1	4	59	50	0.026	
							C + A	<b>913-.401-0P</b>	1	4	59	50	0.026
			M	P	A	<b>933-.401-0P</b>	1	4	59	44	0.026		
						C + A	<b>914-.401-0P</b>	1	4	59	51	0.029	
	4 NC + 4 NO	MA	P	A	<b>924-.401-0P</b>	1	4	59	51	0.029			
					C + A	<b>914-.401-0P</b>	1	4	59	51	0.029		
	M	P	A	<b>934-.401-0P</b>	1	4	59	45	0.029				
				C + A	<b>915-.401-0P</b>	1	4	59	48	0.032			
	5 NC + 5 NO	MA	P	A	<b>925-.401-0P</b>	1	4	59	48	0.032			
					C + A	<b>915-.401-0P</b>	1	4	59	48	0.032		
	M	P	A	<b>935-.401-0P</b>	1	4	59	42	0.032				
				C + A	<b>915-.401-0P</b>	1	4	59	48	0.032			
	64 mm			1 NC + 1 NO	MA	S1	A	<b>921-.401-00</b>		4	58	52	0.024
								C + A	<b>911-.401-00</b>		4	58	52
				M	S1	A	<b>931-.401-00</b>		4	58	46	0.024	
							C + A	<b>912-.401-00</b>		4	58	49	0.025
2 NC + 2 NO				MA	S1	A	<b>922-.401-00</b>		4	58	49	0.025	
							C + A	<b>912-.401-00</b>		4	58	49	0.025
M				S1	A	<b>932-.401-00</b>		4	58	43	0.025		
						C + A	<b>913-.401-00</b>		4	58	50	0.027	
3 NC + 3 NO				MA	S1	A	<b>923-.401-00</b>		4	58	50	0.027	
							C + A	<b>913-.401-00</b>		4	58	50	0.027
M				S1	A	<b>933-.401-00</b>		4	58	44	0.027		
						C + A	<b>914-.401-00</b>		4	58	51	0.030	
4 NC + 4 NO	MA	S1	A	<b>924-.401-00</b>		4	58	51	0.030				
				C + A	<b>914-.401-00</b>		4	58	51	0.030			
M	S1	A	<b>934-.401-00</b>		4	58	45	0.030					
			C + A	<b>915-.401-00</b>		4	58	48	0.033				
5 NC + 5 NO	MA	S1	A	<b>925-.401-00</b>		4	58	48	0.033				
				C + A	<b>915-.401-00</b>		4	58	48	0.033			
M	S1	A	<b>935-.401-00</b>		4	58	42	0.033					
			C + A	<b>915-.401-00</b>		4	58	48	0.033				

Continuation see next page

Continued from previous page

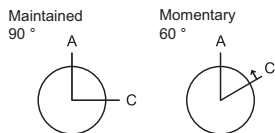

	Front protection	Mounting depth	Contacts	Switching action	Terminals	Key remove	Typ-Nr.	Component layout	Mounting dimensions	Technical drawing	Circuit drawing	
<b>Keylock switch actuator 2 positions 55 mm, flush mounting</b> Standard lock B2 300	IP 65	61 mm	1 NC + 1 NO	MA	P	A	<b>921-.401-WP</b>	1	4	59	52	0.024
						C + A	<b>911-.401-WP</b>	1	4	59	52	0.024
			M	P	A	<b>931-.401-WP</b>	1	4	59	46	0.024	
			2 NC + 2 NO	MA	P	A	<b>922-.401-WP</b>	1	4	59	49	0.025
						C + A	<b>912-.401-WP</b>	1	4	59	49	0.025
			M	P	A	<b>932-.401-WP</b>	1	4	59	43	0.025	
			3 NC + 3 NO	MA	P	A	<b>923-.401-WP</b>	1	4	59	50	0.026
						C + A	<b>913-.401-WP</b>	1	4	59	50	0.026
			M	P	A	<b>933-.401-WP</b>	1	4	59	44	0.026	
			4 NC + 4 NO	MA	P	A	<b>924-.401-WP</b>	1	4	59	51	0.029
						C + A	<b>914-.401-WP</b>	1	4	59	51	0.029
			M	P	A	<b>934-.401-WP</b>	1	4	59	45	0.029	
		5 NC + 5 NO	MA	P	A	<b>925-.401-WP</b>	1	4	59	48	0.032	
					C + A	<b>915-.401-WP</b>	1	4	59	48	0.032	
		M	P	A	<b>935-.401-WP</b>	1	4	59	42	0.032		
		64 mm	1 NC + 1 NO	MA	S1	A	<b>921-.401-W0</b>		4	58	52	0.024
						C + A	<b>911-.401-W0</b>		4	58	52	0.024
			M	S1	A	<b>931-.401-W0</b>		4	58	46	0.024	
			2 NC + 2 NO	MA	S1	A	<b>922-.401-W0</b>		4	58	49	0.025
						C + A	<b>912-.401-W0</b>		4	58	49	0.025
			M	S1	A	<b>932-.401-W0</b>		4	58	43	0.025	
			3 NC + 3 NO	MA	S1	A	<b>923-.401-W0</b>		4	58	50	0.027
						C + A	<b>913-.401-W0</b>		4	58	50	0.027
			M	S1	A	<b>933-.401-W0</b>		4	58	44	0.027	
4 NC + 4 NO	MA		S1	A	<b>924-.401-W0</b>		4	58	51	0.030		
				C + A	<b>914-.401-W0</b>		4	58	51	0.030		
M	S1		A	<b>934-.401-W0</b>		4	58	45	0.030			
5 NC + 5 NO	MA	S1	A	<b>925-.401-W0</b>		4	58	48	0.033			
			C + A	<b>915-.401-W0</b>		4	58	48	0.033			
M	S1	A	<b>935-.401-W0</b>		4	58	42	0.033				

Other key remove and key lock number on request

Hint:

We recommend to use location strip no. 260-0020-00 for anti-twisting of the front bezel.

At momentary position the overturning force is max. 60 Ncm

Contacts: NC = Normally closed, NO = Normally open

Switching action: MA = Maintained action, M = Momentary action

Terminals: P = PCB terminal, S1 = Soldering terminal (also pluggable 2.8 x 0.5 mm)



Component layout from page 83, Mounting dimensions from page 84, Technical drawing from page 88, Circuit drawing from page 99

## Keylock switch actuator 2 positions 70 mm, flush mounting

Actuators usable for front dimensions:  $\varnothing$  24 x 24 mm |  $\square$  24 x 30 mm | 25 mm dia.



### Essential Accessories:

-  Front bezel for Keylock switch and Selector switch 2 positions page 58
-  Front bezel set, flush mounting page 62

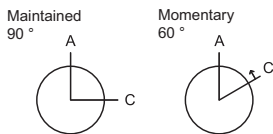

	Front protection	Mounting depth	Contacts	Switching action	Terminals	Key remove	Typ-Nr.	Component layout				Circuit drawing			
								Mounting dimensions	Technical drawing						
<b>Keylock switch actuator 2 positions 70 mm, flush mounting</b> Standard lock B2 300	IP 40	76 mm	1 NC + 1 NO	MA	P	A	<b>821-.401-0P</b>	1	4	61	52	0.026			
							C + A	<b>811-.401-0P</b>	1	4	61	52	0.026		
						M	P	A	<b>831-.401-0P</b>	1	4	61	46	0.026	
			2 NC + 2 NO	MA	P	A	<b>822-.401-0P</b>	1	4	61	49	0.027			
							C + A	<b>812-.401-0P</b>	1	4	61	49	0.027		
						M	P	A	<b>832-.401-0P</b>	1	4	61	43	0.027	
			3 NC + 3 NO	MA	P	A	<b>823-.401-0P</b>	1	4	61	50	0.028			
							C + A	<b>813-.401-0P</b>	1	4	61	50	0.028		
						M	P	A	<b>833-.401-0P</b>	1	4	61	44	0.028	
			4 NC + 4 NO	MA	P	A	<b>824-.401-0P</b>	1	4	61	51	0.031			
							C + A	<b>814-.401-0P</b>	1	4	61	51	0.031		
						M	P	A	<b>834-.401-0P</b>	1	4	61	45	0.031	
	5 NC + 5 NO	MA	P	A	<b>825-.401-0P</b>	1	4	61	48	0.034					
					C + A	<b>815-.401-0P</b>	1	4	61	48	0.034				
				M	P	A	<b>835-.401-0P</b>	1	4	61	42	0.034			
	79 mm			1 NC + 1 NO	MA	S1	A	<b>821-.401-00</b>		4	60	52	0.026		
								C + A	<b>811-.401-00</b>		4	60	52	0.026	
							M	S1	A	<b>831-.401-00</b>		4	60	46	0.026
				2 NC + 2 NO	MA	S1	A	<b>822-.401-00</b>		4	60	49	0.027		
								C + A	<b>812-.401-00</b>		4	60	49	0.027	
							M	S1	A	<b>832-.401-00</b>		4	60	43	0.027
				3 NC + 3 NO	MA	S1	A	<b>823-.401-00</b>		4	60	50	0.029		
								C + A	<b>813-.401-00</b>		4	60	50	0.029	
							M	S1	A	<b>833-.401-00</b>		4	60	44	0.029
4 NC + 4 NO				MA	S1	A	<b>824-.401-00</b>		4	60	51	0.032			
							C + A	<b>814-.401-00</b>		4	60	51	0.032		
						M	S1	A	<b>834-.401-00</b>		4	60	45	0.032	
5 NC + 5 NO	MA	S1	A	<b>825-.401-00</b>		4	60	48	0.035						
				C + A	<b>815-.401-00</b>		4	60	48	0.035					
			M	S1	A	<b>835-.401-00</b>		4	60	42	0.035				

Continuation see next page

Continued from previous page

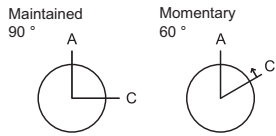

	Front protection	Mounting depth	Contacts	Switching action	Terminals	Key remove	Typ-Nr.	Component layout	Mounting dimensions	Technical drawing	Circuit drawing	
<b>Keylock switch actuator 2 positions 70 mm, flush mounting</b> Standard lock B2 300	IP 65	76 mm	1 NC + 1 NO	MA	P	A	<b>821-.401-WP</b>	1	4	61	52	0.026
						C + A	<b>811-.401-WP</b>	1	4	61	52	0.026
			M	P	A	<b>831-.401-WP</b>	1	4	61	46	0.026	
			2 NC + 2 NO	MA	P	A	<b>822-.401-WP</b>	1	4	61	49	0.027
						C + A	<b>812-.401-WP</b>	1	4	61	49	0.027
			M	P	A	<b>832-.401-WP</b>	1	4	61	43	0.027	
			3 NC + 3 NO	MA	P	A	<b>823-.401-WP</b>	1	4	61	50	0.028
						C + A	<b>813-.401-WP</b>	1	4	61	50	0.028
			M	P	A	<b>833-.401-WP</b>	1	4	61	44	0.028	
			4 NC + 4 NO	MA	P	A	<b>824-.401-WP</b>	1	4	61	51	0.031
						C + A	<b>814-.401-WP</b>	1	4	61	51	0.031
			M	P	A	<b>834-.401-WP</b>	1	4	61	45	0.031	
		5 NC + 5 NO	MA	P	A	<b>825-.401-WP</b>	1	4	61	48	0.034	
					C + A	<b>815-.401-WP</b>	1	4	61	48	0.034	
		M	P	A	<b>835-.401-WP</b>	1	4	61	42	0.034		
		79 mm	1 NC + 1 NO	MA	S1	A	<b>821-.401-W0</b>		4	60	52	0.026
						C + A	<b>811-.401-W0</b>		4	60	52	0.026
			M	S1	A	<b>831-.401-W0</b>		4	60	46	0.026	
			2 NC + 2 NO	MA	S1	A	<b>822-.401-W0</b>		4	60	49	0.027
						C + A	<b>812-.401-W0</b>		4	60	49	0.027
			M	S1	A	<b>832-.401-W0</b>		4	60	43	0.027	
			3 NC + 3 NO	MA	S1	A	<b>823-.401-W0</b>		4	60	50	0.029
						C + A	<b>813-.401-W0</b>		4	60	50	0.029
			M	S1	A	<b>833-.401-W0</b>		4	60	44	0.029	
4 NC + 4 NO	MA		S1	A	<b>824-.401-W0</b>		4	60	51	0.032		
				C + A	<b>814-.401-W0</b>		4	60	51	0.032		
M	S1		A	<b>834-.401-W0</b>		4	60	45	0.032			
5 NC + 5 NO	MA	S1	A	<b>825-.401-W0</b>		4	60	48	0.035			
			C + A	<b>815-.401-W0</b>		4	60	48	0.035			
M	S1	A	<b>835-.401-W0</b>		4	60	42	0.035				

Other key remove and key lock number on request

Hint:

We recommend to use location strip no. 260-0020-00 for anti-twisting of the front bezel.

At momentary position the overturning force is max. 60 Ncm

Contacts: NC = Normally closed, NO = Normally open

Switching action: MA = Maintained action, M = Momentary action

Terminals: P = PCB terminal, S1 = Soldering terminal (also pluggable 2.8 x 0.5 mm)

Component layout from page 83, Mounting dimensions from page 84, Technical drawing from page 88, Circuit drawing from page 99



## Keylock switch actuator 3 positions 45 mm, flush mounting

Actuators usable for front dimensions:  $\varnothing$  24 x 24 mm |  $\square$  24 x 30 mm | 25 mm dia.



### Essential Accessories:

Front bezel for Keylock switch and Selector switch 3 positions page 59

Front bezel set, flush mounting page 62

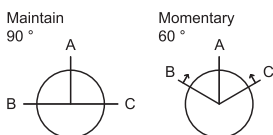

	Front protection	Mounting depth	Contacts	Switching action	Terminals	Key remove	Typ-Nr.	Component layout	Mounting dimensions	Technical drawing	Circuit drawing	
<b>Keylock switch actuator 3 positions 45 mm, flush mounting</b> Standard lock B2 300	IP 40	51 mm	2 NC + 2 NO	0-MA-MA	P	B + A + C	<b>722-.401-0P</b>	1	4	57	40	0.023
				MA-0-MA	P	B + A + C	<b>712-.401-0P</b>	1	4	57	40	0.023
				MA-0-M	P	B + A	<b>742-.401-0P</b>	1	4	57	39	0.023
				M-0-MA	P	C + A	<b>752-.401-0P</b>	1	4	57	38	0.023
		M-0-M	P	A	<b>732-.401-0P</b>	1	4	57	37	0.023		
		54 mm	2 NC + 2 NO	0-MA-MA	S1	B + A + C	<b>722-.401-00</b>		4	56	40	0.023
				MA-0-MA	S1	B + A + C	<b>712-.401-00</b>		4	56	40	0.023
				MA-0-M	S1	B + A	<b>742-.401-00</b>		4	56	39	0.023
	M-0-MA			S1	C + A	<b>752-.401-00</b>		4	56	38	0.023	
	IP 65	51 mm	2 NC + 2 NO	0-MA-MA	P	B + A + C	<b>722-.401-WP</b>	1	4	57	40	0.023
				MA-0-MA	P	B + A + C	<b>712-.401-WP</b>	1	4	57	40	0.023
				MA-0-M	P	B + A	<b>742-.401-WP</b>	1	4	57	39	0.023
				M-0-MA	P	C + A	<b>752-.401-WP</b>	1	4	57	38	0.023
		M-0-M	P	A	<b>732-.401-WP</b>	1	4	57	37	0.023		
		54 mm	2 NC + 2 NO	0-MA-MA	S1	B + A + C	<b>722-.401-W0</b>		4	56	40	0.023
				MA-0-MA	S1	B + A + C	<b>712-.401-W0</b>		4	56	40	0.023
MA-0-M				S1	B + A	<b>742-.401-W0</b>		4	56	39	0.023	
M-0-MA	S1			C + A	<b>752-.401-W0</b>		4	56	38	0.023		
M-0-M	S1	A	<b>732-.401-W0</b>		4	56	37	0.023				

Other key remove and key lock number on request

Hint:

We recommend to use location strip no. 260-0020-00 for anti-twisting of the front bezel.

At momentary position the overturning force is max. 60 Ncm

Contacts: NC = Normally closed, NO = Normally open

Switching action: MA = Maintained action, M = Momentary action

Terminals: P = PCB terminal, S1 = Soldering terminal (also pluggable 2.8 x 0.5 mm)



Component layout from page 83, Mounting dimensions from page 84, Technical drawing from page 88, Circuit drawing from page 99

## Selector switch actuator 2 positions 45 mm, flush mounting

Actuators usable for front dimensions:  $\square$  24 x 24 mm |  $\square$  24 x 30 mm | 25 mm dia.



### Essential Accessories:

-  Front bezel for Keylock switch and Selector switch 2 positions page 58
-  Front bezel set, flush mounting page 62
-  Lever page 60

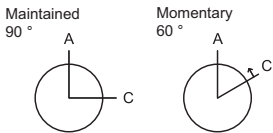

	Front protection	Mounting depth	Contacts	Switching action	Terminals	Typ-Nr.	Component layout	Mounting dimensions	Technical drawing	Circuit drawing	
<b>Selector switch actuator 2 positions 45 mm, flush mounting</b>	IP 40	51 mm	1 NC + 1 NO	MA	P	<b>761-.700-0P</b>	1	16	34	26	0.011
				M	P	<b>781-.700-0P</b>	1	16	34	20	0.011
			2 NC + 2 NO	MA	P	<b>762-.700-0P</b>	1	16	34	28	0.012
				M	P	<b>782-.700-0P</b>	1	16	34	22	0.012
		54 mm	1 NC + 1 NO	MA	S1	<b>761-.700-00</b>		16	33	26	0.011
				M	S1	<b>781-.700-00</b>		16	33	20	0.011
	2 NC + 2 NO	MA	S1	<b>762-.700-00</b>		16	33	28	0.012		
		M	S1	<b>782-.700-00</b>		16	33	22	0.012		
	IP 65	51 mm	1 NC + 1 NO	MA	P	<b>761-.700-WP</b>	1	16	34	26	0.011
				M	P	<b>781-.700-WP</b>	1	16	34	20	0.011
			2 NC + 2 NO	MA	P	<b>762-.700-WP</b>	1	16	34	28	0.012
				M	P	<b>782-.700-WP</b>	1	16	34	22	0.012
54 mm		1 NC + 1 NO	MA	S1	<b>761-.700-W0</b>		16	33	26	0.011	
			M	S1	<b>781-.700-W0</b>		16	33	20	0.011	
2 NC + 2 NO	MA	S1	<b>762-.700-W0</b>		16	33	28	0.012			
	M	S1	<b>782-.700-W0</b>		16	33	22	0.012			

### Hint:

We recommend to use location strip no. 260-0020-00 for anti-twisting of the front bezel.

At momentary position the overturning force is max. 60 Ncm

Contacts: NC = Normally closed, NO = Normally open

Switching action: MA = Maintained action, M = Momentary action

Terminals: P = PCB terminal, S1 = Soldering terminal (also pluggable 2.8 x 0.5 mm)



Component layout from page 83, Mounting dimensions from page 84, Technical drawing from page 88, Circuit drawing from page 99

## Selector switch actuator 2 positions 55 mm, flush mounting

Actuators usable for front dimensions:  $\varnothing 24 \times 24 \text{ mm}$  |  $\varnothing 24 \times 30 \text{ mm}$  | 25 mm dia.



### Essential Accessories:

-  Front bezel for Keylock switch and Selector switch 2 positions page 58
-  Front bezel set, flush mounting page 62
-  Lever page 60

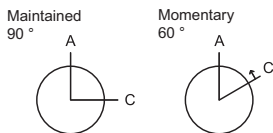

	Front protection	Mounting depth	Contacts	Switching action	Terminals	Typ-Nr.	Component layout	Mounting dimensions	Technical drawing	Circuit drawing		
<b>Selector switch actuator 2 positions 55 mm, flush mounting</b>	IP 40	61 mm	1 NC + 1 NO	MA	P	<b>911-.700-0P</b>	1	16	36	31	0.013	
				M	P	<b>931-.700-0P</b>	1	16	36	25	0.013	
			2 NC + 2 NO	MA	P	<b>912-.700-0P</b>	1	16	36	28	0.014	
				M	P	<b>932-.700-0P</b>	1	16	36	22	0.014	
			3 NC + 3 NO	MA	P	<b>913-.700-0P</b>	1	16	36	29	0.015	
				M	P	<b>933-.700-0P</b>	1	16	36	23	0.015	
			4 NC + 4 NO	MA	P	<b>914-.700-0P</b>	1	16	36	30	0.018	
				M	P	<b>934-.700-0P</b>	1	16	36	24	0.018	
			5 NC + 5 NO	MA	P	<b>915-.700-0P</b>	1	16	36	27	0.022	
				M	P	<b>935-.700-0P</b>	1	16	36	21	0.022	
			64 mm	1 NC + 1 NO	MA	S1	<b>911-.700-00</b>		16	35	31	0.013
					M	S1	<b>931-.700-00</b>		16	35	25	0.013
				2 NC + 2 NO	MA	S1	<b>912-.700-00</b>		16	35	28	0.014
					M	S1	<b>932-.700-00</b>		16	35	22	0.014
				3 NC + 3 NO	MA	S1	<b>913-.700-00</b>		16	35	29	0.015
					M	S1	<b>933-.700-00</b>		16	35	23	0.015
				4 NC + 4 NO	MA	S1	<b>914-.700-00</b>		16	35	30	0.019
					M	S1	<b>934-.700-00</b>		16	35	24	0.019
				5 NC + 5 NO	MA	S1	<b>915-.700-00</b>		16	35	27	0.023
					M	S1	<b>935-.700-00</b>		16	35	21	0.023

Continuation see next page

Continued from previous page

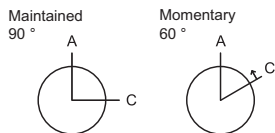

	Front protection	Mounting depth	Contacts	Switching action	Terminals	Typ-Nr.	Component layout	Mounting dimensions	Technical drawing	Circuit drawing		
<b>Selector switch actuator 2 positions 55 mm, flush mounting</b>	IP 65	61 mm	1 NC + 1 NO	MA	P	<b>911-.700-WP</b>	1	16	36	31	0.013	
				M	P	<b>931-.700-WP</b>	1	16	36	25	0.013	
			2 NC + 2 NO	MA	P	<b>912-.700-WP</b>	1	16	36	28	0.014	
				M	P	<b>932-.700-WP</b>	1	16	36	22	0.014	
			3 NC + 3 NO	MA	P	<b>913-.700-WP</b>	1	16	36	29	0.015	
				M	P	<b>933-.700-WP</b>	1	16	36	23	0.015	
			4 NC + 4 NO	MA	P	<b>914-.700-WP</b>	1	16	36	30	0.018	
				M	P	<b>934-.700-WP</b>	1	16	36	24	0.018	
			5 NC + 5 NO	MA	P	<b>915-.700-WP</b>	1	16	36	27	0.022	
				M	P	<b>935-.700-WP</b>	1	16	36	21	0.022	
			64 mm	1 NC + 1 NO	MA	S1	<b>911-.700-W0</b>		16	35	31	0.013
					M	S1	<b>931-.700-W0</b>		16	35	25	0.013
		2 NC + 2 NO		MA	S1	<b>912-.700-W0</b>		16	35	28	0.014	
				M	S1	<b>932-.700-W0</b>		16	35	22	0.014	
		3 NC + 3 NO		MA	S1	<b>913-.700-W0</b>		16	35	29	0.015	
				M	S1	<b>933-.700-W0</b>		16	35	23	0.015	
		4 NC + 4 NO		MA	S1	<b>914-.700-W0</b>		16	35	30	0.019	
				M	S1	<b>934-.700-W0</b>		16	35	24	0.019	
		5 NC + 5 NO		MA	S1	<b>915-.700-W0</b>		16	35	27	0.023	
				M	S1	<b>935-.700-W0</b>		16	35	21	0.023	

**Hint:**

We recommend to use location strip no. 260-0020-00 for anti-twisting of the front bezel.

At momentary position the overturning force is max. 60 Ncm

Contacts: NC = Normally closed, NO = Normally open

Switching action: MA = Maintained action, M = Momentary action

Terminals: P = PCB terminal, S1 = Soldering terminal (also pluggable 2.8 x 0.5 mm)



Component layout from page 83, Mounting dimensions from page 84, Technical drawing from page 88, Circuit drawing from page 99

## Selector switch actuator 2 positions 70 mm, flush mounting

Actuators usable for front dimensions:  $\varnothing$  24 x 24 mm |  $\square$  24 x 30 mm | 25 mm dia.



### Essential Accessories:

-  Front bezel for Keylock switch and Selector switch 2 positions page 58
-  Front bezel set, flush mounting page 62
-  Lever page 60

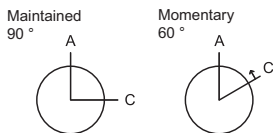

	Front protection	Mounting depth	Contacts	Switching action	Terminals	Typ-Nr.	Component layout	Mounting dimensions	Technical drawing	Circuit drawing		
<b>Selector switch actuator 2 positions 70 mm, flush mounting</b>	IP 40	76 mm	1 NC + 1 NO	MA	P	<b>811-.700-0P</b>	1	16	38	31	0.015	
				M	P	<b>831-.700-0P</b>	1	16	38	25	0.015	
			2 NC + 2 NO	MA	P	<b>812-.700-0P</b>	1	16	38	28	0.016	
				M	P	<b>832-.700-0P</b>	1	16	38	22	0.016	
			3 NC + 3 NO	MA	P	<b>813-.700-0P</b>	1	16	38	29	0.017	
				M	P	<b>833-.700-0P</b>	1	16	38	23	0.017	
			4 NC + 4 NO	MA	P	<b>814-.700-0P</b>	1	16	38	30	0.020	
				M	P	<b>834-.700-0P</b>	1	16	38	24	0.020	
			5 NC + 5 NO	MA	P	<b>815-.700-0P</b>	1	16	38	27	0.024	
				M	P	<b>835-.700-0P</b>	1	16	38	21	0.024	
			79 mm	1 NC + 1 NO	MA	S1	<b>811-.700-00</b>		16	37	31	0.015
					M	S1	<b>831-.700-00</b>		16	37	25	0.015
				2 NC + 2 NO	MA	S1	<b>812-.700-00</b>		16	37	28	0.016
					M	S1	<b>832-.700-00</b>		16	37	22	0.016
	3 NC + 3 NO	MA		S1	<b>813-.700-00</b>		16	37	29	0.017		
		M		S1	<b>833-.700-00</b>		16	37	23	0.017		
	4 NC + 4 NO	MA		S1	<b>814-.700-00</b>		16	37	30	0.021		
		M		S1	<b>834-.700-00</b>		16	37	24	0.021		
	5 NC + 5 NO	MA		S1	<b>815-.700-00</b>		16	37	27	0.025		
		M		S1	<b>835-.700-00</b>		16	37	21	0.025		

Continuation see next page

Continued from previous page

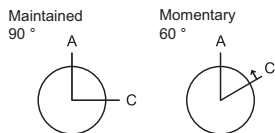

	Front protection	Mounting depth	Contacts	Switching action	Terminals	Typ-Nr.	Component layout	Mounting dimensions	Technical drawing	Circuit drawing		
<b>Selector switch actuator 2 positions 70 mm, flush mounting</b>	IP 65	76 mm	1 NC + 1 NO	MA	P	<b>811-.700-WP</b>	1	16	38	31	0.015	
				M	P	<b>831-.700-WP</b>	1	16	38	25	0.015	
			2 NC + 2 NO	MA	P	<b>812-.700-WP</b>	1	16	38	28	0.016	
				M	P	<b>832-.700-WP</b>	1	16	38	22	0.016	
			3 NC + 3 NO	MA	P	<b>813-.700-WP</b>	1	16	38	29	0.017	
				M	P	<b>833-.700-WP</b>	1	16	38	23	0.017	
			4 NC + 4 NO	MA	P	<b>814-.700-WP</b>	1	16	38	30	0.020	
				M	P	<b>834-.700-WP</b>	1	16	38	24	0.020	
			5 NC + 5 NO	MA	P	<b>815-.700-WP</b>	1	16	38	27	0.024	
				M	P	<b>835-.700-WP</b>	1	16	38	21	0.024	
			79 mm	1 NC + 1 NO	MA	S1	<b>811-.700-W0</b>		16	37	31	0.015
					M	S1	<b>831-.700-W0</b>		16	37	25	0.015
		2 NC + 2 NO		MA	S1	<b>812-.700-W0</b>		16	37	28	0.016	
				M	S1	<b>832-.700-W0</b>		16	37	22	0.016	
		3 NC + 3 NO		MA	S1	<b>813-.700-W0</b>		16	37	29	0.017	
				M	S1	<b>833-.700-W0</b>		16	37	23	0.017	
		4 NC + 4 NO		MA	S1	<b>814-.700-W0</b>		16	37	30	0.021	
				M	S1	<b>834-.700-W0</b>		16	37	24	0.021	
		5 NC + 5 NO		MA	S1	<b>815-.700-W0</b>		16	37	27	0.025	
				M	S1	<b>835-.700-W0</b>		16	37	21	0.025	

**Hint:**

We recommend to use location strip no. 260-0020-00 for anti-twisting of the front bezel.

At momentary position the overturning force is max. 60 Ncm

Contacts: NC = Normally closed, NO = Normally open

Switching action: MA = Maintained action, M = Momentary action

Terminals: P = PCB terminal, S1 = Soldering terminal (also pluggable 2.8 x 0.5 mm)



Component layout from page 83, Mounting dimensions from page 84, Technical drawing from page 88, Circuit drawing from page 99

## Selector switch actuator 3 positions 45 mm, flush mounting

Actuators usable for front dimensions:  $\varnothing 24 \times 24$  mm |  $\varnothing 24 \times 30$  mm | 25 mm dia.



### Essential Accessories:

-  Front bezel for Keylock switch and Selector switch 3 positions page 59
-  Front bezel set, flush mounting page 62
-  Lever page 60

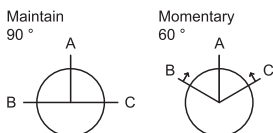

	Front protection	Mounting depth	Contacts	Switching action	Terminals	Typ-Nr.	Component layout	Mounting dimensions	Technical drawing	Circuit drawing	
<b>Selector switch actuator 3 positions 45 mm, flush mounting</b>	IP 40	51 mm	2 NC + 2 NO	0-MA-MA	P	<b>722-.700-0P</b>	1	16	34	19	0.012
				MA-0-MA	P	<b>712-.700-0P</b>	1	16	34	19	0.012
				MA-0-M	P	<b>742-.700-0P</b>	1	16	34	18	0.012
				M-0-MA	P	<b>752-.700-0P</b>	1	16	34	17	0.012
				M-0-M	P	<b>732-.700-0P</b>	1	16	34	16	0.012
		54 mm	2 NC + 2 NO	0-MA-MA	S1	<b>722-.700-00</b>		16	33	19	0.012
				MA-0-MA	S1	<b>712-.700-00</b>		16	33	19	0.012
				MA-0-M	S1	<b>742-.700-00</b>		16	33	18	0.012
				M-0-MA	S1	<b>752-.700-00</b>		16	33	17	0.012
				M-0-M	S1	<b>732-.700-00</b>		16	33	16	0.012
	IP 65	51 mm	2 NC + 2 NO	0-MA-MA	P	<b>722-.700-WP</b>	1	16	34	19	0.012
				MA-0-MA	P	<b>712-.700-WP</b>	1	16	34	19	0.012
				MA-0-M	P	<b>742-.700-WP</b>	1	16	34	18	0.012
				M-0-MA	P	<b>752-.700-WP</b>	1	16	34	17	0.012
				M-0-M	P	<b>732-.700-WP</b>	1	16	34	16	0.012
		54 mm	2 NC + 2 NO	0-MA-MA	S1	<b>722-.700-W0</b>		16	33	19	0.012
				MA-0-MA	S1	<b>712-.700-W0</b>		16	33	19	0.012
				MA-0-M	S1	<b>742-.700-W0</b>		16	33	18	0.012
				M-0-MA	S1	<b>752-.700-W0</b>		16	33	17	0.012
				M-0-M	S1	<b>732-.700-W0</b>		16	33	16	0.012

### Hint:

We recommend to use location strip no. 260-0020-00 for anti-twisting of the front bezel.

At momentary position the overturning force is max. 60 Ncm

Contacts: NC = Normally closed, NO = Normally open

Switching action: MA = Maintained action, M = Momentary action

Terminals: P = PCB terminal, S1 = Soldering terminal (also pluggable 2.8 x 0.5 mm)

Component layout from page 83, Mounting dimensions from page 84, Technical drawing from page 88, Circuit drawing from page 99

## Front

### Lens plastic for button 35 mm

Lens 18 x 18 mm usable for devices with front dimension:  $\square$  24 x 24 mm, flush mounting.

Lens 18 x 24 mm usable with front dimension:  $\square$  24 x 30 mm, flush mounting.

Lens 18 mm dia. usable with front dimension: 25 mm dia., flush mounting.

	Lens	$\square$ 18 x 18 mm Typ-Nr.	$\square$ 18 x 24 mm Typ-Nr.	$\varnothing$ 18 mm Typ-Nr.	
<b>Lens plastic for button 35 mm</b> illuminative	blue translucent	<b>600-3150-00</b>	<b>600-5150-00</b>	<b>600-1150-00</b>	0.001
	green translucent	<b>600-3140-00</b>	<b>600-5140-00</b>	<b>600-1140-00</b>	0.001
	orange translucent	<b>600-3110-00</b>	<b>600-5110-00</b>	<b>600-1110-00</b>	0.001
	red translucent	<b>600-3120-00</b>	<b>600-5120-00</b>	<b>600-1120-00</b>	0.001
	white translucent	<b>600-3160-00</b>	<b>600-5160-00</b>	<b>600-1160-00</b>	0.001
	yellow translucent	<b>600-3170-00</b>	<b>600-5170-00</b>	<b>600-1170-00</b>	0.001
illuminative (not recommended for film insert)	blue transparent	<b>600-3250-00</b>	<b>600-5250-00</b>	<b>600-1250-00</b>	0.001
	green transparent	<b>600-3240-00</b>	<b>600-5240-00</b>	<b>600-1240-00</b>	0.001
	orange transparent	<b>600-3210-00</b>	<b>600-5210-00</b>	<b>600-1210-00</b>	0.001
	red transparent	<b>600-3220-00</b>	<b>600-5220-00</b>	<b>600-1220-00</b>	0.001
	white transparent	<b>600-3260-00</b>	<b>600-5260-00</b>	<b>600-1260-00</b>	0.001
non-illuminative	yellow transparent	<b>600-3270-00</b>	<b>600-5270-00</b>	<b>600-1270-00</b>	0.001
	black opaque	<b>600-3190-00</b>	<b>600-5190-00</b>	<b>600-1190-00</b>	0.001
	grey opaque	<b>600-3180-00</b>	<b>600-5180-00</b>	<b>600-1180-00</b>	0.001





## Lens plastic for buttons 30 - 70 mm and 55 - 70 mm

Lens 18 x 18 mm usable for devices with front dimension:  $\square$  24 x 24 mm, flush mounting.

Lens 18 x 24 mm usable with front dimension:  $\square$  24 x 30 mm, flush mounting.

Lens 18 mm dia. usable with front dimension: 25 mm dia., flush mounting.

	Front protection	Front dimension device	Lens	Typ-Nr.	
<b>Lens plastic for buttons 30 - 70 mm and 55 - 70 mm</b> illuminative	IP 40	18 mm dia.	blue translucent	<b>200-1150-00</b>	0.001
			green translucent	<b>200-1140-00</b>	0.001
			orange translucent	<b>200-1110-00</b>	0.001
			red translucent	<b>200-1120-00</b>	0.001
			white translucent	<b>200-1160-00</b>	0.001
			yellow translucent	<b>200-1170-00</b>	0.001
		18 x 18 mm	blue translucent	<b>200-3150-00</b>	0.001
			green translucent	<b>200-3140-00</b>	0.001
			orange translucent	<b>200-3110-00</b>	0.001
			red translucent	<b>200-3120-00</b>	0.001
			white translucent	<b>200-3160-00</b>	0.001
			yellow translucent	<b>200-3170-00</b>	0.001
		18 x 24 mm	blue translucent	<b>200-5150-00</b>	0.001
			green translucent	<b>200-5140-00</b>	0.001
			orange translucent	<b>200-5110-00</b>	0.001
			red translucent	<b>200-5120-00</b>	0.001
			white translucent	<b>200-5160-00</b>	0.001
			yellow translucent	<b>200-5170-00</b>	0.001
		24 mm dia.	blue translucent	<b>200-7150-00</b>	0.001
			green translucent	<b>200-7140-00</b>	0.001
			orange translucent	<b>200-7110-00</b>	0.001
			red translucent	<b>200-7120-00</b>	0.001
			white translucent	<b>200-7160-00</b>	0.001
			yellow translucent	<b>200-7170-00</b>	0.001
	24 x 24 mm	blue translucent	<b>200-9150-00</b>	0.001	
		green translucent	<b>200-9140-00</b>	0.001	
		orange translucent	<b>200-9110-00</b>	0.001	
		red translucent	<b>200-9120-00</b>	0.001	
		white translucent	<b>200-9160-00</b>	0.001	
		yellow translucent	<b>200-9170-00</b>	0.001	
	IP 65	24 mm dia.	blue translucent	<b>200-7150-W0</b>	0.002
			green translucent	<b>200-7140-W0</b>	0.002
			orange translucent	<b>200-7110-W0</b>	0.002
			red translucent	<b>200-7120-W0</b>	0.002
			white translucent	<b>200-7160-W0</b>	0.002
			yellow translucent	<b>200-7170-W0</b>	0.002
		24 x 24 mm	blue translucent	<b>200-9150-W0</b>	0.002
			green translucent	<b>200-9140-W0</b>	0.002
			orange translucent	<b>200-9110-W0</b>	0.002
			red translucent	<b>200-9120-W0</b>	0.002
			white translucent	<b>200-9160-W0</b>	0.002
			yellow translucent	<b>200-9170-W0</b>	0.002



Continuation see next page

continued from previous page

	Front protection	Front dimension device	Lens	Typ-Nr.		
<b>Lens plastic for buttons 30 - 70 mm and 55 - 70 mm</b> illuminative (not recommended for film insert)	IP 40	18 mm dia.	blue transparent	<b>200-1250-00</b>	0.001	
			green transparent	<b>200-1240-00</b>	0.001	
			orange transparent	<b>200-1210-00</b>	0.001	
			red transparent	<b>200-1220-00</b>	0.001	
			white transparent	<b>200-1260-00</b>	0.001	
			yellow transparent	<b>200-1270-00</b>	0.001	
		18 x 18 mm	blue transparent	<b>200-3250-00</b>	0.001	
			green transparent	<b>200-3240-00</b>	0.001	
			orange transparent	<b>200-3210-00</b>	0.001	
			red transparent	<b>200-3220-00</b>	0.001	
			white transparent	<b>200-3260-00</b>	0.001	
			yellow transparent	<b>200-3270-00</b>	0.001	
		18 x 24 mm	blue transparent	<b>200-5250-00</b>	0.001	
			green transparent	<b>200-5240-00</b>	0.001	
			orange transparent	<b>200-5210-00</b>	0.001	
			red transparent	<b>200-5220-00</b>	0.001	
			white transparent	<b>200-5260-00</b>	0.001	
			yellow transparent	<b>200-5270-00</b>	0.001	
		24 mm dia.	blue transparent	<b>200-7250-00</b>	0.001	
			green transparent	<b>200-7240-00</b>	0.001	
			orange transparent	<b>200-7210-00</b>	0.001	
			red transparent	<b>200-7220-00</b>	0.001	
			white transparent	<b>200-7260-00</b>	0.001	
			yellow transparent	<b>200-7270-00</b>	0.001	
		24 x 24 mm	blue transparent	<b>200-9250-00</b>	0.001	
			green transparent	<b>200-9240-00</b>	0.001	
			orange transparent	<b>200-9210-00</b>	0.001	
			red transparent	<b>200-9220-00</b>	0.001	
			white transparent	<b>200-9260-00</b>	0.001	
			yellow transparent	<b>200-9270-00</b>	0.001	
		IP 65	Ø 24 mm	blue transparent	<b>200-7250-W0</b>	0.002
				green transparent	<b>200-7240-W0</b>	0.002
				orange transparent	<b>200-7210-W0</b>	0.002
				red transparent	<b>200-7220-W0</b>	0.002
				white transparent	<b>200-7260-W0</b>	0.002
				yellow transparent	<b>200-7270-W0</b>	0.002
			24 x 24 mm	blue transparent	<b>200-9250-W0</b>	0.002
				green transparent	<b>200-9240-W0</b>	0.002
				orange transparent	<b>200-9210-W0</b>	0.002
				red transparent	<b>200-9220-W0</b>	0.002
				white transparent	<b>200-9260-W0</b>	0.002
				yellow transparent	<b>200-9270-W0</b>	0.002

Continuation see next page

Continued from previous page

	Front protection	Front dimension device	Lens	Typ-Nr.		
<b>Lens plastic for buttons 30 - 70 mm and 55 - 70 mm</b> non-illuminative	IP 40	18 mm dia.	black opaque	<b>200-1190-00</b>	0.001	
			grey opaque	<b>200-1180-00</b>	0.001	
		18 x 18 mm	black opaque	<b>200-3190-00</b>	0.001	
			grey opaque	<b>200-3180-00</b>	0.001	
		18 x 24 mm	black opaque	<b>200-5190-00</b>	0.001	
			grey opaque	<b>200-5180-00</b>	0.001	
		24 mm dia.	black opaque	<b>200-7190-00</b>	0.001	
			grey opaque	<b>200-7180-00</b>	0.001	
		24 x 24 mm	black opaque	<b>200-9190-00</b>	0.001	
			grey opaque	<b>200-9180-00</b>	0.001	
		IP 65	24 mm dia.	black opaque	<b>200-7190-W0</b>	0.002
				grey opaque	<b>200-7180-W0</b>	0.002
	24 x 24 mm		black opaque	<b>200-9190-W0</b>	0.002	
			grey opaque	<b>200-9180-W0</b>	0.002	

Lens IP 65 is supplied with fitted sealing gland.

## Mushroom-head cap

can only be used with front bezel 18 mm dia.

	Mushroom had cap	⌀ 24 x 24 mm Typ-Nr.	⌀ 18 x 24 mm Typ-Nr.	Ø 24 mm Typ-Nr.	
<b>Mushroom-head cap</b> Front protection IP 40	Plastic black opaque	<b>200-9390-00</b>	<b>200-5390-00</b>	<b>200-7390-00</b>	0.005
	Plastic green opaque	<b>200-9340-00</b>	<b>200-5340-00</b>	<b>200-7340-00</b>	0.005
	Plastic red opaque	<b>200-9320-00</b>	<b>200-5320-00</b>	<b>200-7320-00</b>	0.005
	Plastic yellow opaque	<b>200-9370-00</b>	<b>200-5370-00</b>	<b>200-7370-00</b>	0.005



## Front bezel for Keylock switch and Selector switch 2 positions

Front bezel 18 x 18 mm usable for devices with front dimension:  $\square$  24 x 24 mm, flush mounting.

Front bezel 18 x 24 mm usable with front dimension:  $\square$  24 x 30 mm, flush mounting.

Front bezel 18 mm dia. usable with front dimension: 25 mm dia., flush mounting.

	Front dimension device	Switching action	Marking	Front cap	Typ-Nr.		
<b>Front bezel for Keylock switch and Selector switch 2 positions</b> fits for all Typ-Nr.	18 mm dia.	-	without marking	Plastic black	<b>200-2004-00</b>	0.002	
				Plastic grey	<b>200-1004-00</b>	0.002	
	18 x 18 mm	-	without marking	Plastic black	<b>200-4004-00</b>	0.002	
				Plastic grey	<b>200-3004-00</b>	0.002	
	18 x 24 mm	-	without marking	Plastic black	<b>200-6004-00</b>	0.002	
				Plastic grey	<b>200-5004-00</b>	0.002	
	24 mm dia.	-	without marking	Plastic black	<b>200-8004-00</b>	0.002	
				Plastic grey	<b>200-7004-00</b>	0.002	
	24 x 24 mm	-	without marking	Plastic black	<b>200-0004-00</b>	0.002	
				Plastic grey	<b>200-9004-00</b>	0.002	
	for Typ-Nr. 761-xxx ... 772-xxx   911-xxx ... 925-xxx   811-xxx ... 825-xxx	18 mm dia.	0-MA	0 - I (90°)	Plastic black	<b>200-2001-00</b>	0.002
					Plastic grey	<b>200-1001-00</b>	0.002
18 x 18 mm		0-MA	0 - I (90°)	Plastic black	<b>200-4001-00</b>	0.002	
				Plastic grey	<b>200-3001-00</b>	0.002	
18 x 24 mm		0-MA	0 - I (90°)	Plastic black	<b>200-6001-00</b>	0.002	
				Plastic grey	<b>200-5001-00</b>	0.002	
24 mm dia.		0-MA	0 - I (90°)	Plastic black	<b>200-8001-00</b>	0.002	
				Plastic grey	<b>200-7001-00</b>	0.002	
24 x 24 mm		0-MA	0 - I (90°)	Plastic black	<b>200-0001-00</b>	0.002	
				Plastic grey	<b>200-9001-00</b>	0.002	
for Typ-Nr. 781-xxx   782-xxx   931-xxx ... 935- xxx   831-xxx ... 835-xxx	18 mm dia.	0-M	0 - I (60°)	Plastic black	<b>200-2001-01</b>	0.002	
				Plastic grey	<b>200-1001-01</b>	0.002	
	18 x 18 mm	0-M	0 - I (60°)	Plastic black	<b>200-4001-01</b>	0.002	
				Plastic grey	<b>200-3001-01</b>	0.002	
	18 x 24 mm	0-M	0 - I (60°)	Plastic black	<b>200-6001-01</b>	0.002	
				Plastic grey	<b>200-5001-01</b>	0.002	
	24 mm dia.	0-M	0 - I (60°)	Plastic black	<b>200-8001-01</b>	0.002	
				Plastic grey	<b>200-7001-01</b>	0.002	
	24 x 24 mm	0-M	0 - I (60°)	Plastic black	<b>200-0001-01</b>	0.002	
				Plastic grey	<b>200-9001-01</b>	0.002	



Front bezel and switch will be delivered assembled

Switching action: - = without, MA =

## Front bezel for Keylock switch and Selector switch 3 positions

Front bezel 18 x 18 mm usable for devices with front dimension:  $\square$  24 x 24 mm, flush mounting.

Front bezel 18 x 24 mm usable with front dimension:  $\square$  24 x 30 mm, flush mounting.

Front bezel 18 mm dia. usable with front dimension: 25 mm dia., flush mounting.

	Front dimension device	Switching action	Marking	Front cap	Typ-Nr.		
<b>Front bezel for Keylock switch and Selector switch 3 positions</b> fits for all Typ-Nr.	18 mm dia.	-	without marking	Plastic black	<b>200-2004-00</b>	0.002	
				Plastic grey	<b>200-1004-00</b>	0.002	
	18 x 18 mm	-	without marking	Plastic black	<b>200-4004-00</b>	0.002	
				Plastic grey	<b>200-3004-00</b>	0.002	
	18 x 24 mm	-	without marking	Plastic black	<b>200-6004-00</b>	0.002	
				Plastic grey	<b>200-5004-00</b>	0.002	
	24 mm dia.	-	without marking	Plastic black	<b>200-8004-00</b>	0.002	
				Plastic grey	<b>200-7004-00</b>	0.002	
	24 x 24 mm	-	without marking	Plastic black	<b>200-0004-00</b>	0.002	
				Plastic grey	<b>200-9004-00</b>	0.002	
	for Typ-Nr. 712-xxx	18 mm dia.	MA-0-MA	I (90°) - 0 - II (90°)	Plastic black	<b>200-2002-00</b>	0.002
					Plastic grey	<b>200-1002-00</b>	0.002
18 x 18 mm		MA-0-MA	I (90°) - 0 - II (90°)	Plastic black	<b>200-4002-00</b>	0.002	
				Plastic grey	<b>200-3002-00</b>	0.002	
18 x 24 mm		MA-0-MA	I (90°) - 0 - II (90°)	Plastic black	<b>200-6002-00</b>	0.002	
				Plastic grey	<b>200-5002-00</b>	0.002	
24 mm dia.		MA-0-MA	I (90°) - 0 - II (90°)	Plastic black	<b>200-8002-00</b>	0.002	
				Plastic grey	<b>200-7002-00</b>	0.002	
24 x 24 mm		MA-0-MA	I (90°) - 0 - II (90°)	Plastic black	<b>200-0002-00</b>	0.002	
				Plastic grey	<b>200-9002-00</b>	0.002	
for Typ-Nr. 722-xxx	18 mm dia.	0-MA-MA	0 (90°) - I - II (90°)	Plastic black	<b>200-2003-01</b>	0.002	
				Plastic grey	<b>200-1003-01</b>	0.002	
	18 x 18 mm	0-MA-MA	0 (90°) - I - II (90°)	Plastic black	<b>200-4003-01</b>	0.002	
				Plastic grey	<b>200-3003-01</b>	0.002	
	18 x 24 mm	0-MA-MA	0 (90°) - I - II (90°)	Plastic black	<b>200-6003-01</b>	0.002	
				Plastic grey	<b>200-5003-01</b>	0.002	
	24 mm dia.	0-MA-MA	0 (90°) - I - II (90°)	Plastic black	<b>200-8003-01</b>	0.002	
				Plastic grey	<b>200-7003-01</b>	0.002	
	24 x 24 mm	0-MA-MA	0 (90°) - I - II (90°)	Plastic black	<b>200-0003-01</b>	0.002	
				Plastic grey	<b>200-9003-01</b>	0.002	
for Typ-Nr. 732-xxx	18 mm dia.	M-0-M	I (60°) - 0 - II (60°)	Plastic black	<b>200-2002-02</b>	0.002	
				Plastic grey	<b>200-1002-02</b>	0.002	
	18 x 18 mm	M-0-M	I (60°) - 0 - II (60°)	Plastic black	<b>200-4002-02</b>	0.002	
				Plastic grey	<b>200-3002-02</b>	0.002	
	18 x 24 mm	M-0-M	I (60°) - 0 - II (60°)	Plastic black	<b>200-6002-02</b>	0.002	
				Plastic grey	<b>200-5002-02</b>	0.002	
	24 mm dia.	M-0-M	I (60°) - 0 - II (60°)	Plastic black	<b>200-8002-02</b>	0.002	
				Plastic grey	<b>200-7002-02</b>	0.002	
	24 x 24 mm	M-0-M	I (60°) - 0 - II (60°)	Plastic black	<b>200-0002-02</b>	0.002	
				Plastic grey	<b>200-9002-02</b>	0.002	



Continuation see next page

Continued from previous page

	Front dimension device	Switching action	Marking	Front cap	Typ-Nr.	
<b>Front bezel for Keylock switch and Selector switch 3 positions</b> for Typ-Nr. 742-xxx	18 mm dia.	MA-0-M	I (90°) - 0 - II (60°)	Plastic black	<b>200-2002-03</b>	0.002
				Plastic grey	<b>200-1002-03</b>	0.002
	18 x 18 mm	MA-0-M	I (90°) - 0 - II (60°)	Plastic black	<b>200-4002-03</b>	0.002
				Plastic grey	<b>200-3002-03</b>	0.002
	18 x 24 mm	MA-0-M	I (90°) - 0 - II (60°)	Plastic black	<b>200-6002-03</b>	0.002
				Plastic grey	<b>200-5002-03</b>	0.002
	24 mm dia.	MA-0-M	I (90°) - 0 - II (60°)	Plastic black	<b>200-8002-03</b>	0.002
				Plastic grey	<b>200-7002-03</b>	0.002
	24 x 24 mm	MA-0-M	I (90°) - 0 - II (60°)	Plastic black	<b>200-0002-03</b>	0.002
				Plastic grey	<b>200-9002-03</b>	0.002
for Typ-Nr. 752-xxx	18 mm dia.	M-0-MA	I (60°) - 0 - II (90°)	Plastic black	<b>200-2002-04</b>	0.002
				Plastic grey	<b>200-1002-04</b>	0.002
	18 x 18 mm	M-0-MA	I (60°) - 0 - II (90°)	Plastic black	<b>200-4002-04</b>	0.002
				Plastic grey	<b>200-3002-04</b>	0.002
	18 x 24 mm	M-0-MA	I (60°) - 0 - II (90°)	Plastic black	<b>200-6002-04</b>	0.002
				Plastic grey	<b>200-5002-04</b>	0.002
	24 mm dia.	M-0-MA	I (60°) - 0 - II (90°)	Plastic black	<b>200-8002-04</b>	0.002
				Plastic grey	<b>200-7002-04</b>	0.002
	24 x 24 mm	M-0-MA	I (60°) - 0 - II (90°)	Plastic black	<b>200-0002-04</b>	0.002
				Plastic grey	<b>200-9002-04</b>	0.002

Front bezel and switch will be delivered assembled

Switching action: - = without, MA = Maintained action, M = Momentary action

## Lever



	Lever	Typ-Nr.	
<b>Lever</b>	Plastic black long	<b>200-904-00</b>	0.001
	Plastic black short	<b>200-704-00</b>	0.001
	Plastic chromium-plated long	<b>200-804-00</b>	0.001
	Plastic chromium-plated short	<b>200-604-00</b>	0.001



Lever and switch will be delivered assembled

## Buzzer element

Buzzer element 18 x 24 mm usable for devices with front dimension:  24 x 30 mm, flush mounting.

	Colour	 24 x 24 mm Typ-Nr.	 18 x 24 mm Typ-Nr.	
<b>Buzzer element</b> Operation voltage : 12 VAC/DC	black	<b>970-0012-00</b>	<b>970-6012-00</b>	0.004
	grey	<b>970-9012-00</b>	<b>970-5012-00</b>	0.004
Operation voltage : 24 VAC/DC	black	<b>970-0024-00</b>	<b>970-6024-00</b>	0.004
	grey	<b>970-9024-00</b>	<b>970-5024-00</b>	0.004
Operation voltage : 6 VAC/DC	black	<b>970-0006-00</b>	<b>970-6006-00</b>	0.004
	grey	<b>970-9006-00</b>	<b>970-5006-00</b>	0.004



## Push-pull knob

	Lever	Typ-Nr.	
<b>Push-pull knob</b>	Plastic blue transparent	<b>200-255-00</b>	0.003
	Plastic green transparent	<b>200-245-00</b>	0.003
	Plastic red transparent	<b>200-225-00</b>	0.003
	Plastic white transparent	<b>200-265-00</b>	0.003
	Plastic yellow transparent	<b>200-275-00</b>	0.003



## Front bezel for buttons 30 - 70 mm and 55 - 70 mm

Front bezel 18 x 18 mm usable for devices with front dimension:  $\square$  24 x 24 mm, flush mounting.

Front bezel 18 x 24 mm usable for devices with front dimension:  $\square$  24 x 30 mm, flush mounting.

Front bezel 18 mm dia. usable for devices with front dimension: 25 mm dia., flush mounting.

	Front protection	Front dimension device	Front bezel	Typ-Nr.	
<b>Front bezel for buttons 30 - 70 mm and 55 - 70 mm</b>	IP 40	18 mm dia.	Plastic black	<b>200-2000-00</b>	0.002
			Plastic grey	<b>200-1000-00</b>	0.002
		18 x 18 mm	Plastic black	<b>200-4000-00</b>	0.002
			Plastic grey	<b>200-3000-00</b>	0.002
		18 x 24 mm	Plastic black	<b>200-6000-00</b>	0.002
			Plastic grey	<b>200-5000-00</b>	0.002
		24 mm dia.	Plastic black	<b>200-8000-00</b>	0.002
			Plastic grey	<b>200-7000-00</b>	0.002
		24 x 24 mm	Plastic black	<b>200-0000-00</b>	0.002
			Plastic grey	<b>200-9000-00</b>	0.002
	IP 65	24 mm dia.	Plastic black	<b>200-8000-W0</b>	0.002
			Plastic grey	<b>200-7000-W0</b>	0.002
		24 x 24 mm	Plastic black	<b>200-0000-W0</b>	0.002
			Plastic grey	<b>200-9000-W0</b>	0.002



Front bezel IP 65 is supplied with fitted sealing ring.

## Front bezel for Mushroom-head pushbutton 55 - 70 mm

	Front protection	Front bezel	$\varnothing$ 18 Typ-Nr.	
<b>Front bezel for Mushroom-head pushbutton 55 - 70 mm</b>	IP 40	Plastic black	<b>200-2000-00</b>	0.002
		Plastic grey	<b>200-1000-00</b>	0.002



## Front bezel for Buzzer for 30- 55 mm

Front bezel 18 x 24 mm usable for devices with front dimension: □ 24 x 30 mm, flush mounting.

	Front protection	Front bezel	□ 24 x 24 mm Typ-Nr.	□ 18 x 24 mm Typ-Nr.	kg
Front bezel for Buzzer for 30- 55 mm	IP 40	Plastic black	<b>200-0000-00</b>	<b>200-6000-00</b>	0.002
		Plastic grey	<b>200-9000-00</b>	<b>200-5000-00</b>	0.002



## Front bezel set, flush mounting

	Front protection	Front bezel	□ 24 x 24 mm Typ-Nr.	□ 24 x 30 mm Typ-Nr.	∅ 25 mm Typ-Nr.	kg
Front bezel set, flush mounting	IP 65	Plastic black	<b>200-4400-V0</b>			0.007
				<b>200-6400-V0</b>		0.008
					<b>200-8400-V0</b>	0.006

For use as IP 40: Cut off (with knife) the anti-twisting at the front bezel/actuator



## Front bezel set Buzzer, flush mounting

	Front protection	Front bezel	□ 24 x 30 mm Typ-Nr.	kg
Front bezel set Buzzer, flush mounting	IP 65	Plastic black	<b>200-6400-V0</b>	0.008

For use as IP 40: Cut off (with knife) the anti-twisting at the front bezel/actuator



## Protective cover for buttons 35 mm

	Front protection	□ 18 x 18 mm Typ-Nr.	□ 18 x 24 mm Typ-Nr.	Technical drawing	kg
Protective cover for buttons 35 mm hinged, transparent, with means for sealing	IP 40	<b>200-4008-00</b>	<b>200-6008-00</b>	62	0.002
	IP 65	<b>200-4008-W0</b>	<b>200-6008-W0</b>	62	0.002



Technical drawing from page 88



## Protective cover for buttons 55 - 70 mm

	Front protection	Typ-Nr.	Typ-Nr.	Typ-Nr.	Technical drawing	
		∅ 24 x 24 mm	∅ 18 x 18 mm	∅ 18 x 24 mm		
		Typ-Nr.	Typ-Nr.	Typ-Nr.		
<b>Protective cover for buttons 55 - 70 mm</b> hinged, transparent, not with means for sealing	IP 65	<b>200-0008-W0</b>			62	0.006
hinged, transparent, with means for sealing	IP 40		<b>200-4008-00</b>	<b>200-6008-00</b>	62	0.002

For use as IP 40: Cut off (with knife) the anti-twist device at the front bezel/actuator.  
Technical drawing from page 88



## Protective cover illuminated pusbutton | Key lock switch, flush mounting

	Front protection	Typ-Nr.	Typ-Nr.	Technical drawing		
		Protective cover	∅ 24 x 24 mm	∅ 24 x 30 mm		
			Typ-Nr.	Typ-Nr.		
<b>Protective cover illuminated pusbutton  </b> <b>Key lock switch, flush mounting</b>	IP 65	Plastic black	<b>200-4408-V0</b>		1	0.006
hinged, transparent, with means for sealing				<b>200-6408-V0</b>	2	0.006

For use as IP 40: Cut off (with knife) the anti-twist device at the front bezel/actuator.  
Technical drawing from page 88



## Front protective cap

	Front protection	Typ-Nr.	Typ-Nr.	
		Front protective cap	∅ 18 x 18 mm	∅ 18 x 24 mm
			Typ-Nr.	Typ-Nr.
<b>Front protective cap</b> 24 x 24 mm, two-part, illumination exchangeable from the front	IP 65	PVC natural transparent	<b>200-3009-W0</b>	
24 x 30 mm, two-part, illumination exchangeable from the front	IP 65	Silicone natural transparent		<b>200-5009-W0</b>

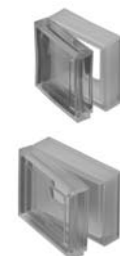

## Protective guard for Illuminated pushbutton 55 - 70 mm

	⌀ 18 x 18 mm Typ-Nr.	⌀ 18 x 24 mm Typ-Nr.	Ø 18 mm Typ-Nr.	 kg
<b>Protective guard for Illuminated pushbutton 55 - 70 mm</b> 18 x 20 mm, Aluminium anodized natural	<b>200-3007-00</b>			0.002
20 x 24 mm, Aluminium anodized natural		<b>200-5007-00</b>		0.002
20 mm dia., Aluminium anodized natural			<b>200-1007-00</b>	0.002



## Pressure ring for Indicator 30 - 70mm

suitable to front bezel IP 65, 24 mm dia. and 24 x 24 mm

	Typ-Nr.	 kg
<b>Pressure ring for Indicator 30 - 70mm</b> Plastic	<b>200-8009-W0</b>	0.001



## Sealing ring for Indicator 30 - 70 mm | Illuminated pushbutton 55 - 70 mm

suitable to front bezel IP 65, 24 mm dia. and 24 x 24 mm

	Typ-Nr.	 kg
<b>Sealing ring for Indicator 30 - 70 mm   Illuminated pushbutton 55 - 70 mm</b> Silicone	<b>200-9009-W0</b>	0.001



## Sealing bulb for Indicator 30 - 70 mm | Illuminated pushbutton 55 - 70 mm

suitable to front bezel IP 65, 24 mm dia. and 24 x 24 mm

	Typ-Nr.	 kg
<b>Sealing bulb for Indicator 30 - 70 mm   Illuminated pushbutton 55 - 70 mm</b> Silicone	<b>200-7009-W0</b>	0.001



## Blind plug

	Front protection	Blind plug	∅ 24 x 24 mm Typ-Nr.	∅ 18 x 18 mm Typ-Nr.	∅ 18 x 24 mm Typ-Nr.	∅ 18 mm Typ-Nr.	
<b>Blind plug</b> Mounting hole size 16.2 mm dia.	IP 65	Plastic black	<b>200-0006-W0</b>	<b>200-4006-W0</b>	<b>200-6006-W0</b>	<b>200-2006-W0</b>	0.003
	IP 40	Plastic black		<b>200-4006-00</b>	<b>200-6006-00</b>	<b>200-2006-00</b>	0.003
		Plastic grey		<b>200-3006-00</b>	<b>200-5006-00</b>	<b>200-1006-00</b>	0.003



## Spare key

	Typ-Nr.	
<b>Spare key</b> Emergency-stop pushbutton with key to release, Standard lock 1001	<b>240-4001-00</b>	0.005
Keylock switch, Standard lock B2 300	<b>240-2001-00</b>	0.005
Stop pushbutton, Standard lock B2 390	<b>240-3001-00</b>	0.005



At ordering indicate marked lock no.

## Backside

### Snap-action switching element block for 35 mm

	Switching system	Contacts	Contact material	Terminals	Typ-Nr.	Component layout		kg
						Component layout	Circuit drawing	
Snap-action switching element block for 35 mm	SA	1 NC + 1 NO	Gold	P	<b>601-0000-0P</b>	1	36	0.006
				S1	<b>601-0000-00</b>		36	0.006
		1 NC + 1 NO + 1 D	Gold	P	<b>608-0000-0P</b>	1	34	0.006
				S1	<b>608-0000-00</b>		34	0.006
		1 NC + 1 NO + 2 D	Gold	P	<b>609-0000-0P</b>	1	33	0.006
				S1	<b>609-0000-00</b>		33	0.006
		2 NC + 2 NO	Gold	P	<b>602-0000-0P</b>	1	35	0.006
				S1	<b>602-0000-00</b>		35	0.006



Switching system: SA = Snap-action switching element  
 Contacts: NC = Normally closed, NO = Normally open, D = Diode  
 Terminals: P = PCB terminal, S1 = Soldering terminal (also pluggable 2.8 x 0.5 mm)  
 Component layout from page 83, Circuit drawing from page 99

### Lamp element block for 35 mm

	Dioden (1N4007)	Terminals	Typ-Nr.	Component layout		kg
				Component layout	Circuit drawing	
Lamp element block for 35 mm	1 D	P	<b>606-0000-0P</b>	1	4	0.006
		S1	<b>606-0000-00</b>		4	0.006
	2 D	P	<b>607-0000-0P</b>	1	3	0.006
		S1	<b>607-0000-00</b>		3	0.006
	-	P	<b>600-0000-0P</b>	1	2	0.005
		S1	<b>600-0000-00</b>		2	0.005



Dioden (1N4007): D = Diode, - = without  
 Terminals: P = PCB terminal, S1 = Soldering terminal (also pluggable 2.8 x 0.5 mm)  
 Component layout from page 83, Circuit drawing from page 99

### Blind element

	Typ-Nr.	kg
Blind element white	<b>202-0600-00</b>	0.002



## Lamp terminal

	Terminals	Typ-Nr.	
Lamp terminal	P	<b>270-0000-0P</b>	0.001
	S1	<b>270-0000-00</b>	0.001



Terminals: P = PCB terminal, S1 = Soldering terminal (also pluggable 2.8 x 0.5 mm)

## Intermediate section

	Typ-Nr.	
<b>Intermediate section</b> for Illuminated pushbutton 55 mm, T1 3/4 MG, incl. Fixing nut	<b>260-9000-00</b>	0.005
for Illuminated pushbutton 55 mm, T5.5, incl. Fixing nut	<b>260-8000-00</b>	0.008



## Snap-action switching element

	Switching system	Contacts	Contact material	Terminals	Typ-Nr.	Technical drawing	
<b>Snap-action switching element</b> blue	SA	1 NC + 1 NO	Gold	S1	<b>201-0500-00</b>	9	0.003
green	SA	1 NC + 1 NO	Gold	S1	<b>201-0400-00</b>	9	0.003
grey	SA	1 NC + 1 NO	Gold	P	<b>221-0800-0P</b>	9	0.003
				S1	<b>201-0800-00</b>	9	0.003



Switching system: SA = Snap-action switching element

Contacts: NC = Normally closed, NO = Normally open

Terminals: S1 = Soldering terminal (also pluggable 2.8 x 0.5 mm), P = PCB terminal

Technical drawing from page 88

## Holder for 2 Switching elements

	Typ-Nr.	
<b>Holder for 2 Switching elements</b> Plastic, Pushbutton 35 mm, Keylock switch 45 mm   Selector switch 45 mm	<b>270-3000-00</b>	0.001
Plastic, Push-Pull illuminated pushbutton	<b>270-2000-00</b>	0.001



## Holder for 3 Switching elements

	Typ-Nr.	 kg
<b>Holder for 3 Switching elements</b> Stainless steel, Illuminated pushbutton 55 - 70 mm	<b>270-1000-00</b>	0.001



## Spring with pin

for maintained version at the intermediate section

	Typ-Nr.	 kg
<b>Spring with pin</b> Illuminated pushbutton 55 - 70 mm	<b>260-0010-00</b>	0.001



## PCB plug-in base

	Terminals	Typ-Nr.	 kg
<b>PCB plug-in base</b>	P	<b>280-1210-00</b>	0.006
1 NC + 1 NO with lamp terminal, for devices 35 mm   45 mm, Pins 90° bent at right-angle	P	<b>280-1110-00</b>	0.005
1 NC + 1 NO with lamp terminal, for devices 35 mm   45 mm, Pins axial	P	<b>280-1100-00</b>	0.005
1 NC + 1 NO with lamp terminal, for devices 55 - 70 mm, Pins axial	P	<b>280-1200-00</b>	0.006
1 NC + 1 NO with lamp terminal, for devices 55 - 70 mm, Pins bent at right angle	P	<b>280-2100-00</b>	0.005
2 NC + 2 NO with lamp terminal, for devices 35 mm   45 mm   55 - 70 mm, Pins 90° axial	P	<b>280-2200-00</b>	0.006
2 NC + 2 NO with lamp terminal, for devices 35 mm   45 mm   55 - 70 mm, Pins 90° bent at right-angle	P	<b>280-3100-00</b>	0.005
3 NC + 3 NO with lamp terminal, for devices 35 mm   45 mm   55 - 70 mm, Pins 90° axial	P	<b>280-3200-00</b>	0.006
3 NC + 3 NO with lamp terminal, for devices 35 mm   45 mm   55 - 70 mm, Pins 90° bent at right-angle	P	<b>280-0100-00</b>	0.005
Indicator 35 mm   30 - 70 mm, Pins axial	P	<b>280-0200-00</b>	0.006
Indicator 35 mm   30 - 70 mm, Pins bent at right-angle	P		

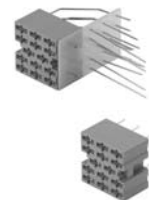

Terminals: P = PCB terminal

## Multi-plug housing

	Typ-Nr.	 kg
<b>Multi-plug housing</b> for Flat receptacle with locating tongue, 14 terminal possibilities, 10 terminals plugable max.	<b>280-0000-00</b>	0.002



## Flat receptacle

	Typ-Nr.	
<b>Flat receptacle</b> 2.8 x 0.5 mm with locating tongue for Multi pug-in housing, wire cross-section 0.1 ... 0.25 mm <sup>2</sup>	<b>280-0001-00</b>	0.001
2.8 x 0.5 mm with locating tongue for Multi pug-in housing, wire cross-section 0.5 ... 1.0 mm <sup>2</sup>	<b>280-0002-00</b>	0.001
2.8 x 0.5 mm without locating tongue, exclusive of Insulation sleeve Typ-Nr. 280-0010-00 use, wire cross-section 0.2 ... 0.75 mm <sup>2</sup>	<b>280-0003-00</b>	0.001



## Flat receptacle with two outputs

	Typ-Nr.	
<b>Flat receptacle with two outputs</b> 2.8 x 0.5 mm	<b>280-0004-00</b>	0.001



## Insulation sleeve

	Typ-Nr.	
<b>Insulation sleeve</b> for Flat receptacle without locating tongue Typ-Nr. 280-0003-00	<b>280-0010-00</b>	0.001



## Illumination

### Filament lamp

	Socket	Operating voltage/-current	Typ-Nr.	
<b>Filament lamp</b>	T1 3/4 MG	14 VAC/DC, 80 mA	<b>10-1310.1319</b>	0.001
		28 VAC/DC, 40 mA	<b>10-1313.1249</b>	0.001
		36 VAC/DC, 30 mA	<b>10-1316.1209</b>	0.001
		48 VAC/DC, 25 mA	<b>10-1319.1199</b>	0.001
		6.3 VAC/DC, 200 mA	<b>10-1307.1369</b>	0.001
	T5.5	12 VAC/DC, 100 mA	<b>10-1109.1329</b>	0.001
		24 VAC/DC, 50 mA	<b>10-1112.1279</b>	0.001
		36 VAC/DC, 35 mA	<b>10-1116.1229</b>	0.001
		48 VAC/DC, 25 mA	<b>10-1119.1199</b>	0.001
		6 VAC/DC, 200 mA	<b>10-1106.1369</b>	0.001



## Single-LED

Single-LED	Socket	Light colour	Operating voltage/-current	Typ-Nr.	 kg
Single-LED	T1 3/4 MG	blue	12 VAC/DC, 7/14 mA	<b>10-2J09.1066</b>	0.002
			24 VAC/DC, 7/14 mA	<b>10-2J12.1066</b>	0.002
			28 VAC/DC, 7/14 mA	<b>10-2J13.1066</b>	0.002
			48 VAC/DC, 4/8 mA	<b>10-2J19.1046</b>	0.002
			6 VDC, 15 mA	<b>10-2J06.3146</b>	0.002
		green	12 VAC/DC, 4/7 mA	<b>10-2J09.1065</b>	0.002
			24 VAC/DC, 4/7 mA	<b>10-2J12.1065</b>	0.002
			28 VAC/DC, 4/7 mA	<b>10-2J13.1065</b>	0.002
			48 VAC/DC, 2/4 mA	<b>10-2J19.1045</b>	0.002
			6 VDC, 7 mA	<b>10-2J06.3145</b>	0.002
		red	12 VAC/DC, 7/14 mA	<b>10-2J09.1062</b>	0.002
			24 VAC/DC, 7/14 mA	<b>10-2J12.1062</b>	0.002
			28 VAC/DC, 7/14 mA	<b>10-2J13.1062</b>	0.002
			48 VAC/DC, 4/8 mA	<b>10-2J19.1042</b>	0.002
			6 VDC, 15 mA	<b>10-2J06.3142</b>	0.002
		white diffuse	12 VAC/DC, 7/14 mA	<b>10-2J09.1069</b>	0.002
			24 VAC/DC, 7/14 mA	<b>10-2J12.1069</b>	0.002
			28 VAC/DC, 7/14 mA	<b>10-2J13.1069</b>	0.002
			48 VAC/DC, 4/8 mA	<b>10-2J19.1049</b>	0.002
			6 VDC, 15 mA	<b>10-2J06.3149</b>	0.002
		yellow	12 VAC/DC, 7/14 mA	<b>10-2J09.1064</b>	0.002
			24 VAC/DC, 7/14 mA	<b>10-2J12.1064</b>	0.002
			28 VAC/DC, 7/14 mA	<b>10-2J13.1064</b>	0.002
			48 VAC/DC, 4/8 mA	<b>10-2J19.1044</b>	0.002
	6 VDC, 15 mA		<b>10-2J06.3144</b>	0.002	
	T5.5	blue	12 VAC/DC, 7/14 mA	<b>10-2109.1066</b>	0.001
			24 VAC/DC, 7/14 mA	<b>10-2112.1066</b>	0.001
			28 VAC/DC, 7/14 mA	<b>10-2113.1066</b>	0.001
			48 VAC/DC, 4/8 mA	<b>10-2119.1046</b>	0.001
			6 VDC, 15 mA	<b>10-2106.3146</b>	0.001
		green	12 VAC/DC, 7/14 mA	<b>10-2109.1065</b>	0.001
			24 VAC/DC, 7/14 mA	<b>10-2112.1065</b>	0.001
			28 VAC/DC, 7/14 mA	<b>10-2113.1065</b>	0.001
			48 VAC/DC, 4/8 mA	<b>10-2119.1045</b>	0.001
			6 VDC, 15 mA	<b>10-2106.3145</b>	0.001
		red	12 VAC/DC, 7/14 mA	<b>10-2109.1062</b>	0.001
			24 VAC/DC, 7/14 mA	<b>10-2112.1062</b>	0.001
			28 VAC/DC, 7/14 mA	<b>10-2113.1062</b>	0.001
			48 VAC/DC, 4/8 mA	<b>10-2119.1042</b>	0.001
			6 VDC, 15 mA	<b>10-2106.3142</b>	0.001
		white diffuse	12 VAC/DC, 7/14 mA	<b>10-2109.1069</b>	0.001
			24 VAC/DC, 7/14 mA	<b>10-2112.1069</b>	0.001
			28 VAC/DC, 7/14 mA	<b>10-2113.1069</b>	0.001
			48 VAC/DC, 4/8 mA	<b>10-2119.1049</b>	0.001
			6 VDC, 15 mA	<b>10-2106.3149</b>	0.001
		yellow	12 VAC/DC, 7/14 mA	<b>10-2109.1064</b>	0.001
			24 VAC/DC, 7/14 mA	<b>10-2112.1064</b>	0.001
			28 VAC/DC, 7/14 mA	<b>10-2113.1064</b>	0.001
48 VAC/DC, 4/8 mA			<b>10-2119.1044</b>	0.001	
6 VDC, 15 mA	<b>10-2106.3144</b>		0.001		



Note:  
AC operation through halve-wave rectifier possible, slight flickering can occur.



## Diode element

	Dioden (1N4007)	Terminals	Typ-Nr.	
<b>Diode element</b> red	1 D	P	<b>222-0100-0P</b>	0.003
		S1	<b>212-0100-00</b>	0.003
	2 D	P	<b>214-0100-0P</b>	0.003
		S1	<b>213-0100-00</b>	0.003



Dioden (1N4007): D = Diode

Terminals: P = PCB terminal, S1 = Soldering terminal (also pluggable 2.8 x 0.5 mm)

## Series resistor

for lamp voltage reduction

	Operating voltage	Typ-Nr.	
<b>Series resistor</b> 10 kΩ, for filament lamp 48 V / 1.2 W	240 V	<b>300-0050-00</b>	0.002
2.7 kΩ, for filament lamp 48 V / 1.2 W	110 V	<b>300-0010-00</b>	0.002
3.3 kΩ, for filament lamp 48 V / 1.2 W	125 V	<b>300-0020-00</b>	0.002
4.7 kΩ, for filament lamp 48 V / 1.2 W	145 V	<b>300-0030-00</b>	0.002



Please keep to the country specific security rules.

## Terminal plate empty

for fitting with series resistors

	Typ-Nr.	
<b>Terminal plate empty</b> 10 spaces 125 x 60 x 15 mm	<b>300-0110-00</b>	0.045
15 spaces 187.5 x 60 x 15 mm	<b>300-0115-00</b>	0.090
20 spaces 250 x 60 x 15 mm	<b>300-0120-00</b>	0.095
5 spaces 62.5 x 60 x 15 mm	<b>300-0105-00</b>	0.025



## Emergency-stop pushbutton

### Label for Emergency-stop and Stop pushbutton

	Front protection	Marking	Typ-Nr.	
<b>Label for Emergency-stop and Stop pushbutton</b> 43 mm dia., yellow	IP 40	ARRET D'URGENCE	<b>200-1300-04</b>	0.002
		EMERGENCY STOP	<b>200-1300-03</b>	0.002
		NOT HALT	<b>200-1300-08</b>	0.002
		NOT-AUS	<b>200-1300-02</b>	0.002
		without	<b>200-1300-01</b>	0.002
	IP 65	ARRET D'URGENCE	<b>200-1300-W4</b>	0.002
		EMERGENCY STOP	<b>200-1300-W3</b>	0.002
		NOT HALT	<b>200-1300-W8</b>	0.002
		NOT-AUS	<b>200-1300-W2</b>	0.002
		without	<b>200-1300-W1</b>	0.002



Other options on request

### Slow-make switching element for Stop pushbutton

	Switching system	Contacts	Contact material	Terminals	Typ-Nr.	Technical drawing	
<b>Slow-make switching element for Stop pushbutton</b> grey	SM	1 NC	Gold	P	<b>231+0800-0P</b>	10	0.003
				S1	<b>211+0800-00</b>	10	0.003



Switching system: SM = Slow-make switching element

Contacts: NC = Normally closed

Terminals: P = PCB terminal, S1 = Soldering terminal (also pluggable 2.8 x 0.5 mm)

Technical drawing from page 88

### Dismantling tool for Emergency-stop pushbutton, foolproof

	Typ-Nr.	
<b>Dismantling tool for Emergency-stop pushbutton, foolproof</b>	<b>300-0017-00</b>	0.004



## Assembling

### Fixing nut, raised mounting

	Typ-Nr.	
<b>Fixing nut, raised mounting</b>	<b>260-0003-00</b>	0.001
Plastic black, panel thickness 1 ... 3 mm, for devices 35 mm		
Plastic grey, panel thickness 1 ... 3 mm, for devices 30 - 70 mm	<b>260-0001-00</b>	0.001
Plastic grey, panel thickness 3 ... 5 mm, for devices 30 - 70 mm	<b>260-0002-00</b>	0.001
Plastic grey, panel thickness 5 ... 7 mm, for devices 30 - 70 mm	<b>260-0005-00</b>	0.001



### Fixing nut, flush mounting

	Typ-Nr.	
<b>Fixing nut, flush mounting</b>	<b>260-0003-00</b>	0.001
Plastic black, panel thickness 1 ... 3 mm, for devices 35 mm		
Plastic grey, panel thickness 3 ... 5 mm, for devices 30 - 70 mm	<b>260-0002-00</b>	0.001



### Location strip, raised mounting

All devices without Emergency-stop pushbutton foolproof

	Typ-Nr.	
<b>Location strip, raised mounting</b>	<b>260-0020-00</b>	0.001
Anti-twist device, in-line arrays or single switches, graduation 18 mm		
Anti-twist device, in-line arrays or single switches, graduation 24 mm	<b>260-0021-00</b>	0.001



### Lens remover

	Typ-Nr.	
<b>Lens remover</b>	<b>300-0001-00</b>	0.012



### Lamp remover

	Typ-Nr.	
<b>Lamp remover</b>	<b>300-0002-00</b>	0.003



CAUTION

A switching process might be released when replacing the lamp/LED !

### Mounting tool

	Typ-Nr.	
<b>Mounting tool</b>	<b>300-0003-00</b>	0.007
for tightening (or loosening) of the Fixing nut (at dismantled Element block)		



## Contact element pliers

	Typ-Nr.	 kg
<b>Contact element pliers</b> for dismantling the switching elements off the holder for 3 switching elements	<b>300-0005-00</b>	0.013



## Jaw spanner

	Typ-Nr.	 kg
<b>Jaw spanner</b> for tightening (or loosening) fixing nut and dismantling of the element blocks (mounting depth 35 - 70 mm)	<b>300-0004-00</b>	0.003



## Flat receptacle remover

	Typ-Nr.	 kg
<b>Flat receptacle remover</b> for removing the Flat receptacle from the Multi-plug housing (280-0000-00)	<b>300-0006-00</b>	0.001



## Device

### General

Swisstac switches are modularly designed. They are divided in three groups :

1. Front  
Interface Human-Switch with state detector.
2. Intermediate section  
Set and reset device, lamp holder, latching funktion.
3. Switching element block  
Up to 5 switching elements can be integrated in a switching element block.

Each switch is tested fully mounted. Electrical output and service life are determined by the switching element. Front and intermediate section are designed for maximum service life of the switching element. They determine in what way the switches are protected against external influences. The type approvals relate to the complete switch.

### Environmental conditions

#### Shock resistance

(single impacts, semi-sinusoidal)  
500 m/s<sup>2</sup>, puls width 11 ms, as per EN IEC 60068-2-27  
max. 150 m/s<sup>2</sup>, pulse width 11 ms, as per EN IEC 60068-2-29

#### Vibration resistance

(sinusoidal)  
max. 100 m/s<sup>2</sup> at 10 Hz ... 500 Hz, as per EN IEC 60068-2-6

### Approvals

#### Approbations

CSA  
ENEC (EN 61058)  
UL  
VDE

#### Declaration of conformity

CE  
RoHS

## Front

### General

The front notifies the switching status, serves for activation of the switch and determines its type of protection. With the exception of the front 18 mm dia. of the illuminated pushbuttons 55 and 70 mm, all front bezel elements have activation protection.

### Material

#### Lens

Polycarbonate (PC), as per UL94 V0

#### Front bezel

Polybutylene terephthalate (PBT), as per UL94 V0

#### Actuator 35 mm

Polybutylene terephthalate (PBT), as per UL94 V0

#### Lock housing

Polybutylene terephthalate (PBT), as per UL94 V0

#### Lock cylinder

Polybutylenterephthalat reinforced with carbon fibre (PBT)  
sealing bulb IP 65 (Silicone)

### Environmental conditions

#### Protection degree

IP 67, IP 65 or IP 40, as per EN IEC 60529

## Intermediate section

### General

The intermediate section integrates characteristics as setting, reset function and click-stop device. Besides all for a switch necessary parts, like front parts, switching block and lamps, are fastened at the intermediate section.

### Material

#### Housing

Polycarbonate (PC), as per UL94 V0

#### Lamp terminal

Nickel silver

### Mechanical characteristics

#### Mechanical lifetime

Illuminated pushbutton	>2 million	cycles of operation
Keylock- and Selector switch	>50 000	cycles of operation
Emergency-stop switch	>8 000	cycles of operation
Illuminated push-pull switch	>250 000	cycles of operation

### Electrical characteristics

#### Electric strength

3750 VAC, 50 Hz, 1 min., as per EN IEC 61058-1

#### Isolation resistance

>10<sup>12</sup> Ω as per DIN IEC 60512-2-10

### Environmental conditions

#### Storage temperature

-40 °C ... +85 °C, as per EN IEC 60068

#### Operating temperature

-25 °C ... +55 °C, as per EN IEC 60068-2

## Switching element block

### General

Up to five independent switching elements can be integrated in the switching element block as a switching unit. There are four different types of switching elements available.

1. Snap-action switching element
2. Slow-make Stop switching element
3. Diode element
4. Blind element

### Material

#### Holder for 2 switching elements

Polyamide (PA 6), as per UL 94 V0

## Holder for 3 switching elements

Stainless steel

## Lamp terminal

CuBe, 2 µm Optalloy

## Mechanical characteristics

### Terminals

Soldering terminal (also pluggable 2.8 x 0.5 mm) or PCB terminal, Brass gold plated  
Wire cross-section 1.0 mm<sup>2</sup> max.

## Electrical characteristics

### Electric strength

2500 VAC, 50 Hz, 1 min. (functional isolation)

### Isolation resistance

>10<sup>12</sup> Ω

## Snap-action switching element

## Switching system

Is equipped with double-break jump contacts. Owing to the large cleaning path, outstanding self-cleaning is possible. The multilayer contacts are designed for universal use. They are gilded with a 2 µm gold coating. Each snap-action switching element comprises a NC (normally closed contact) and a NO (normally open contact).

## Material

### Housing

Polyethylene terephthalate (PETP), as per UL 94 V0

### Contacts

AgNi, 2 µm gold plated

### Contact carrier

Brass or CuBe

## Mechanical characteristics

### Terminals

Soldering terminal (also pluggable 2.8 x 0.5 mm) or PCB terminal, Brass gold plated  
Wire cross-section 1.0 mm<sup>2</sup> max.

### Actuating force

For each snap-action switching element approx. 2 N

### Rebound time

typically 0.5 µs

### Contact opening width

2 x 0.65 mm

### Contact cleaning path

2 x 0.6 mm

### Mechanical lifetime

2 million cycles of operation

## Electrical characteristics

### Contact resistance

New state with gold plated contact ≤50 mΩ, statically

## Electrical life

>10 000 cycles of operation

EN IEC 60947-5-1, AC-12

Voltage 24 V 48 V 75 V 110 V 250 V

Current 6 A 6 A 5 A 2 A 0.5 A

EN IEC 61058-1 (inductive)

Voltage 250 V

Current 1.5 A

## Conventional free air thermal current I<sub>th</sub>

6 A from 1 to 3-poles switching element block

4 A for 4- and 5-poles Switching element block. Limited on thermal reasons to I<sub>max</sub> = 4 A

## Switch rating

as per EN IEC 61058-1

250 V, 5 A (non-inductive) up to 3 switching elements

250 V, 4 A (non-inductive) with 4 or 5 switching elements

250 V, 1.5 A (inductive) up to 3 switching elements

250 V, 1 A (inductive) with 4 or 5 switching elements

5 VAC/DC, 1 mA min.

## Environmental conditions

### Storage temperature

-40 °C ... +85 °C, as per EN IEC 60068

### Operating temperature

-25 °C ... +55 °C, as per EN IEC 60068-2

## Slow-make switching element Stop pushbutton

## Switching system

Is equipped with rigid contact link. The slow-make element opens positively and simply consists of a double-break NC. The multilayer contacts are designed for universal use and are gilded with a 2 µm gold coating. The Stop slow-make element is designed according to EN IEC 60947-5-1.

## Material

### Housing

Rynite (PET), as per UL 94 V0

### Contacts

AgNi, 2 µm gold plated

### Contact carrier

Brass or CuBe

## Mechanical characteristics

### Terminals

Soldering terminal (also pluggable 2.8 x 0.5 mm) or PCB terminal, Brass gold plated  
Wire cross-section 1.0 mm<sup>2</sup> max.

### Contact opening width

>2 x 1.5 mm

### Mechanical lifetime

8 000 cycles of operation

## Electrical characteristics

### Rated Operational Voltage U<sub>e</sub>

250 VAC, as per EN IEC 60947-1

## Rated Insulation Voltage $U_i$

250 V, as per EN IEC 60947-1

## Electrical life

8000 cycles of operation at 250 VAC, 1 A

## Conventional free air thermal current $I_{th}$

5 A, as per EN IEC 60947-5-1

## Switch rating

Switch rating AC with silver contact (gold plated), 250 VAC, 1 A, service category AC-15, as per EN IEC 60947-5-1

## Short-circuit protection

Series-connected blow-out fuse 5 A gL

## Environmental conditions

### Storage temperature

-40 °C ... +85 °C, as per EN IEC 60068

### Operating temperature

-25 °C ... +55 °C, as per EN IEC 60068-2

## Emergency-stop pushbutton foolproof

## Switching system

Self cleaning, double-break slow-make element with four-path contacts (contact opening width 2 x 1.5 mm). The slow-make elements are constructed as per EN IEC 60947-5-1.

## Material

### Mushroom-head cap

Polyamide (PA)

### Actuator housing

Polyetherimide (PEI), self-extinguishing

### Switching element

Polyamide (PA), Polysulfon (PSU)

### Material of contact

Silver (Ag)

## Mechanical characteristics

### Terminals

Soldering terminal

max. wire-cross section 2 x 1.0 mm<sup>2</sup>

max. wire-cross section of stranded cable 1 x 0.75 mm<sup>2</sup>

also pluggable 2.8 x 0.5 mm

### Actuating force

max. 65 N (measured on mushroom-head cap)

### Unlock torque

15 Ncm

### Actuating travel

10 mm

### Rebound time

≤2 ms

### Mechanical lifetime

50 000 cycles of operations

## Electrical characteristics

### Rated Operational Voltage $U_e$

250 VAC, as per EN IEC 60947-1

### Rated Insulation Voltage $U_i$

300 VAC, as per EN IEC 60947-5-1

### Contact resistance

New state ≤50 mΩ, as per DIN IEC 60512-2-5

### Electrical life

6050 cycles of operation

### Conventional free air thermal current $I_{th}$

5 A, as per EN IEC 60947-5-1

the maximum current in continuous operation and at ambient temperature must not exceed the quoted maximum values.

### Switch rating

Switch rating AC (inductive) with silver contact (gold plated), service category AC-13, as per EN IEC 60947-5-1

Voltage	24 VAC	60 VAC	120 VAC	250 VAC
Current	6 A	6 A	5 A	3 A

Switch rating AC (inductive) with silver contact (gold plated), service category AC-14, as per EN IEC 60947-5-1

Current	24 VAC	60 VAC	120 VAC	250 VAC
Voltage	5 A	4 A	3 A	2 A

Switch rating (non-inductive) with silver contact (gold-plated)

Voltage	24 VDC	60 VDC	110 VDC	240 VDC
Current	6.0 A	2.0 A	0.7 A	0.5 A

Switch rating DC with silver contact (gold plated), service category DC-13, as per EN IEC 60947-5-1

Voltage	24 VDC	60 VDC	110 VDC	240 VDC
Current	2.0 A	1.0 A	0.4 A	0.2 A

### Recommended minimum operational data

Silver contact (Soldering terminal) 20 VAC, 10 mA

### Electric strength

4000 VAC, 50 Hz, 1 min., as per DIN IEC 60512-2 between all terminals and earth

### Short-circuit protection

Series-connected blow-out fuse 10 A gL

### Overvoltage category

III, as per EN IEC 60947-5-1

### Degree of pollution

3, as per EN IEC 60947-1

## Environmental conditions

### Storage temperature

-40 °C ... +85 °C, as per EN IEC 60068

### Operating temperature

-25 °C ... +55 °C, as per EN IEC 60068-2

### Shock resistance

(single impacts, semi-sinusoidal)

500 m/s<sup>2</sup>puls width 11 ms, as per EN IEC 60068-2-27

## Vibration resistance

(sinusoidal)

max. 100 m/s<sup>2</sup> at 10 Hz ... 2000 Hz, amplitude 0.75 mm, as per EN IEC 60068-2-6

## Protection degree

as per EN IEC 60529

Frontside IP 65 | backside IP 40

## Approvals

### Approbations

CSA

UL

VDE

### Declaration of conformity

CE

RoHS

## Electrical characteristics

### Operating voltage

6, 12 and 24 V AC/DC ±10 %

### Power consumption

approx. 13 mA

### Acoustics

approx. 84 dB at 0.1 m

### Frequency (tone)

approx. 2.3 kHz

## Diode element

### General

No switching function. Diodes are soldered into the switching element housing between the contact connections.

### Material

#### Housing

Polyethylene terephthalate (PETP), as per UL 94 V0

### Mechanical characteristics

#### Terminals

Soldering terminal (also pluggable 2.8 x 0.5 mm) or PCB terminal,

Brass gold plated

Wire cross-section 1.0 mm<sup>2</sup> max.

### Electrical characteristics

#### Diode

1N4007, rated current = 1.0 A,  $V_{RRM} = 1000$  V

## Blind element

### General

Insert in empty places in the switching element block. Non-conducting and without electrical function.

### Material

#### Housing

Polybutylene terephthalate (PBT), as per UL94 V0

## Buzzer

### General

Device with reverse-connect protection.

### Mechanical characteristics

#### Terminals

Soldering terminal (also pluggable 2.8 x 0.5 mm) or PCB terminal,

Brass gold plated

Wire cross-section 1.0 mm<sup>2</sup> max.



## General notes

**Switch interlock systems do away with complicated protective and relay interlocks.**

SWISSTAC switches with mounting depths of 55 mm and 70 mm can be combined into interlocking systems of up to 20 switches. The only exception is variant 7 of the interlocking system with pushbutton (see below), where the maximum number of combined switches is 10. The switches are mechanically interlocked. There are two types to choose from:

1. Switch interlock system with pushbutton
2. Switch interlock system with keylock switch

The distance separating switches in an interlock system can be increased in steps of 6 mm from a minimum of 18 mm (between switch centre-lines). Irregular spacings and/or blanks in a system are also possible. No special cutouts in the fascia panel are required, as the hole patterns match the individual switches.

All switch interlock systems are supplied ready for mounting. Splash-proof versions are obtainable with bezels of 24 mm dia. or 24 x 24 mm. The interlock system withstands a pressure of at least 50 N.

## Variants of switch interlock system

For each type of switch interlock system there is a choice of seven different variants:

### Variant 1

Momentary action possible only with one pushbutton at a time, as the buttons are interactively blocked mechanically.

### Variant 2

Maintained action of one pushbutton at a time. This blocks the other buttons mechanically and is only released by pressing the actuated pushbutton again.

### Variant 3

Maintained action of one pushbutton at a time. If an other button is pressed, the first resets. One button is normally always "On".

### Variant 4

Maintained action of one pushbutton at a time. If an other button is pressed, the first resets. The release button cancels the "On" condition.

### Variant 5

Maintained action of one or more pushbuttons pressed simultaneously. If one or more buttons are operated simultaneously, the button or group of buttons pressed before are reset. Switching "Off" is done only with the release button.

### Variant 6

Maintained action of one pushbutton at a time. Another button cannot be operated until the first has been reset with the release button. All buttons are then at "Zero".

### Variant 7

Maintained action of any one switch, which can also be operated one after the other. Actuated buttons can only be reset with the release button.

Action	Variant						
	1	2	3	4	5	6	7
latching		●	●	●	●	●	●
mutual mechanical release			●	●	●		
individual release by pressing again		●					
all released with release button				●	●	●	●
mutual mechanical blocking	●	●	●	●		●	

## Switch interlock system with pushbutton

All dimensions in mm

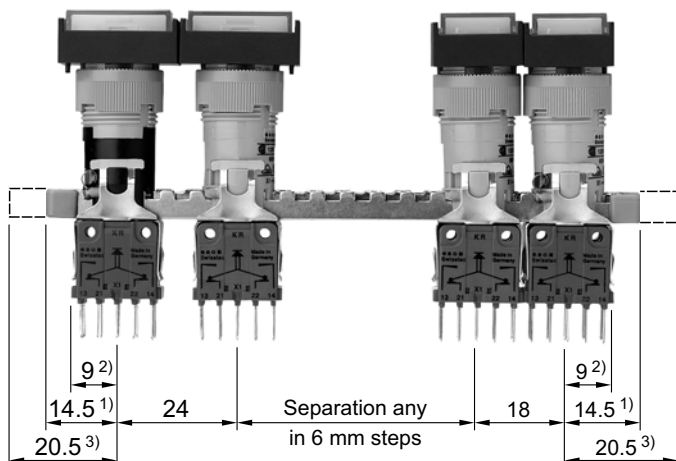

Centre line (CL) spacing

- 1) for variants 1, 3 - 7                      14.5 mm
- 2) for variants 1, 3 - 7                      reduction to 9.0 mm at extra cost
- 3) for variant 2                                    at least 20.5 mm

## Standard switch interlock system with keylock switch

For dimensions, see Standard switch interlock system.

All dimensions in mm

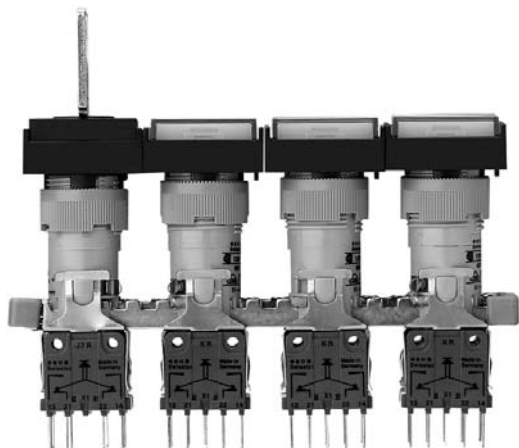

Including keylock switches in a switch interlock system with mechanical blocking and release functions allows close supervision of the switches status, and restricts operation to authorized personal.

There is a choice of three types of switch interlock systems with keylock switch. They differ according to their function:

- |                   |   |   |
|-------------------|---|---|
| <b>Function 1</b> | <b>Controls switching "On"</b><br>Possible with variants 3, 4, 6        | Zero position: Unrestricted operation.<br>Maintained action position: Resets actuated switches to zero position and the same time blocks all switches.  |
| <b>Function 2</b> | <b>Controls switching "Off"</b><br>Possible for variants 6, 7           | Zero position: Switching "On" is possible.<br>Momentary action position: Turning the keylock switch to the momentary action position resets the actuated switches to the zero position (keylock switch with momentary action mode replaces release button). |
| <b>Funktion 3</b> | <b>Controls switching "On" and "Off"</b><br>Possible for variants 1 - 7 | Zero position: Unrestricted operation.<br>Maintained action position: Locks all switches at their present setting.  |

## Suppressor circuits

When switching inductive loads such as relays, DC motors, and DC solenoids, it is always important to absorb surges (e.g. with a diode) to protect the contacts. When these inductive loads are switched off, a counter emf can severely damage switch contacts and greatly shorten lifetime.

Fig. 1 shows an inductive load with a free-wheeling diode connected in parallel. This free-wheeling diode provides a path for the inductor current to flow when the current is interrupted by the switch. Without this free-wheeling diode, the voltage across the coil will be limited only by dielectric breakdown voltages of the circuit or parasitic elements of the coil. This voltage can be kilovolts in amplitude even when nominal circuit voltages are low (e.g. 12 VDC) see Fig. 2.

The free-wheeling diode should be chosen so that the reverse breakdown voltage is greater than the voltage driving the inductive load. The DC blocking voltage (VR) of the free-wheeling diode can be found in the datasheet of a diode. The forward current should be equal or greater than the maximum current flowing through the load.

**To get an efficient protection, the free-wheeling diode must be connected as close as possible to the inductive load!**

Switching with inductive load  
Fig. 1



Counter emf  
over load without free-wheeling diode  
Fig. 2



## General notes

### Engraving

The lens top or lens holder can be engraved in the most commonly used world languages, in DIN 1451-3 close spacing, other typefaces are available.

#### Colour lettering

White for lens tops red, blue, green and black. Black for lens tops orange, yellow, grey and white. Black for lens holders translucent and transparent.

#### Important !

With engraving, the position of the lens must agree with the position of the pushbutton or indicator. However, the lens can be mounted turned through 180 °.

### Hot stamping

For lettering any sizeable quantity we recommend pad printing on the lens holder.

#### Important !

With pad printing, the position of the lens must agree with the position of the pushbutton or indicator. However, the lens can be mounted turned through 180 °.

### Film inserts

Instead of engraving, a transparent foil can be laid in the lens tops, except with the colours grey and black.

Film thickness is 0.1 mm max..

#### Important !

When a foil is used, the position of the lens must agree with the position of the pushbutton or indicator. However, the lens can be mounted turned through 180 °. With round lenses the film can rotate.

All dimensions in mm

Front size	Film insert max. size	Height of letters h	Number of lines	Number of (target value) capital letters per line	Image
18 dia.	12.7 dia.	2.5	2	5	B6
		3.0	2	5	B6
		4.0	1	3	B6
		5.0	1	2	B6
18 x 18 (15.3 x 15.3)	12.7 x 12.7	2.5	3	5	B2
		3.0	3	5	B2
		4.0	2	3	B2
		5.0	1	3	B2
18 x 24 horizontal position	12.7 x 18.9	2.5	3	8	B3
		3.0	3	8	B3
		4.0	2	5	B3
		5.0	1	5	B3
18 x 24 vertical position	12.7 x 18.9	2.5	5	5	B4
		3.0	4	5	B4
		4.0	3	3	B4
		5.0	2	3	B4
24 dia.	18.3 dia.	2.5	4	7	B5
		3.0	3	7	B5
		4.0	3	4	B5
		5.0	2	3	B5
24 x 24	18.3 x 18.3	2.5	5	8	B1
		3.0	4	8	B1
		4.0	3	6	B1
		5.0	2	5	B1

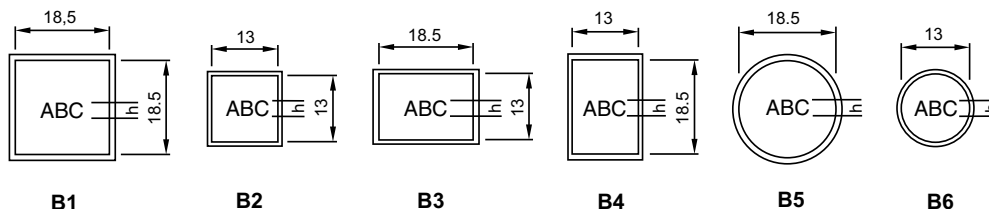
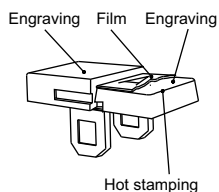

## Component layout

1 Buzzer actuator 30 - 55 mm page 11 | Illuminated pushbutton actuator 55 - 70 mm page 12 | Stop pushbutton 55 - 70 mm page 13 | Mushroom-head pushbutton actuator 55 - 70 mm page 16 | Keylock switch actuator 2 positions 45 mm page 17 | Keylock switch actuator 2 positions 55 mm page 18 | Keylock switch actuator 2 positions 70 mm page 20 | Keylock switch actuator 3 positions 45 mm page 22 | Selector switch actuator 2 positions 45 mm page 23 | Selector switch actuator 2 positions 55 mm page 24 | Selector switch actuator 2 positions 70 mm page 26 | Selector switch actuator 3 positions 45 mm page 28 | Illuminated push-pull pushbutton actuator 45 mm page 29 | Illuminated pushbutton actuator 55 - 70 mm, momentary, switch interlock system variants 1, 3 - 7 page 30 | Illuminated pushbutton actuator 55 - 70 mm, maintained, switch interlock system variant 2 page 31 | Release button actuator 55 - 70 mm, momentary, switch interlock system variants 4 - 7 page 32 | Keylock switch 2 positions actuator 55 - 70 mm, momentary, switch interlock system function 2 page 33 | Keylock switch actuator 2 positions 55 mm, maintained, switch interlock system functions 1 and 3 page 35 | Keylock switch 2 positions actuator 70 mm, maintained, switch interlock system functions 1 and 3 page 37 | Indicator actuator 30 - 70 mm, flush mounting page 39 | Illuminated pushbutton actuator 55 - 70 mm, flush mounting page 41 | Keylock switch actuator 2 positions 45 mm, flush mounting page 42 | Keylock switch actuator 2 positions 55 mm, flush mounting page 43 | Keylock switch actuator 2 positions 70 mm, flush mounting page 45 | Keylock switch actuator 3 positions 45 mm, flush mounting page 47 | Selector switch actuator 2 positions 45 mm, flush mounting page 48 | Selector switch actuator 2 positions 55 mm, flush mounting page 49 | Selector switch actuator 2 positions 70 mm, flush mounting page 51 | Selector switch actuator 3 positions 45 mm, flush mounting page 53 | Snap-action switching element block for 35 mm page 66 | Lamp element block for 35 mm page 66

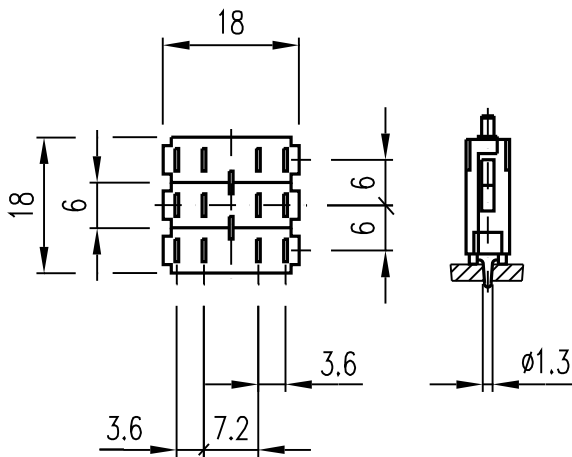

## Mounting dimensions

1 Selector switch actuator 2 positions 45 mm page 23 | Selector switch actuator 2 positions 55 mm page 24 | Selector switch actuator 2 positions 70 mm page 26 | Selector switch actuator 3 positions 45 mm page 28

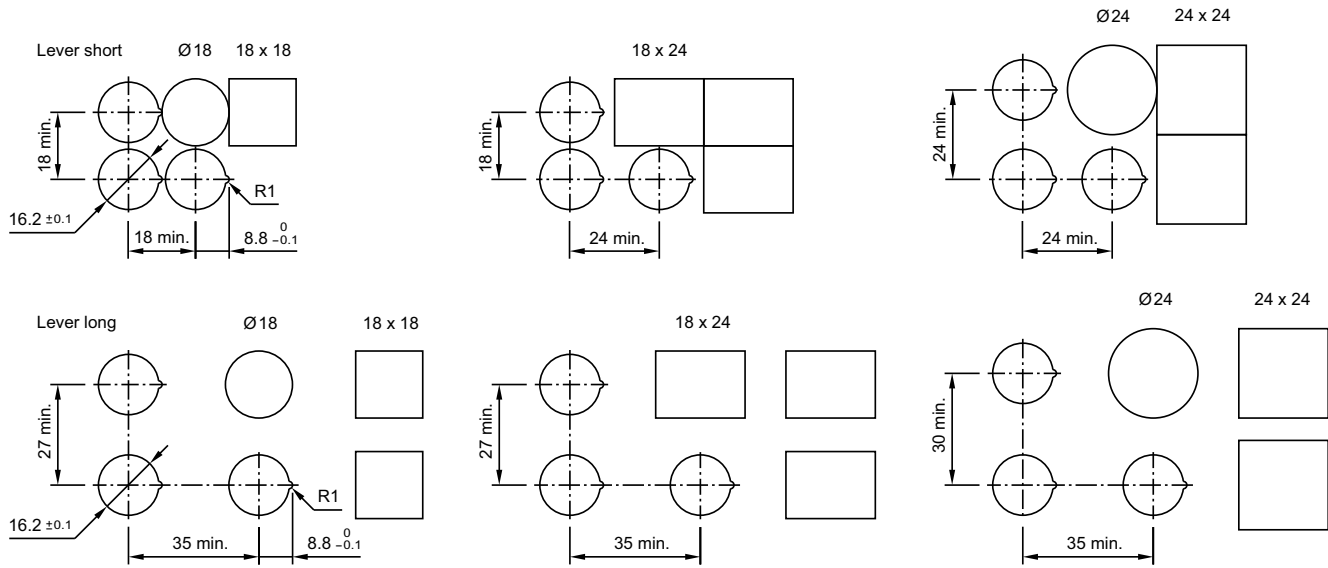

IP 40

2 Selector switch actuator 2 positions 45 mm page 23 | Selector switch actuator 2 positions 55 mm page 24 | Selector switch actuator 2 positions 70 mm page 26 | Selector switch actuator 3 positions 45 mm page 28

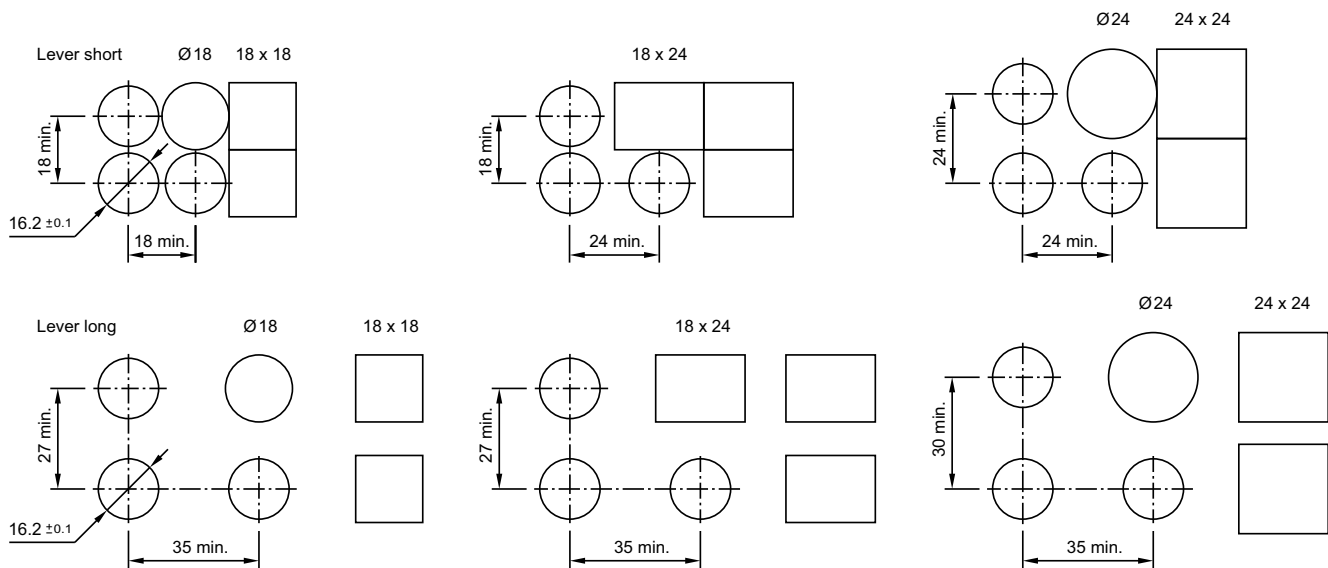

IP 65

### 3 Emergency-stop pushbutton, foolproof EN IEC 60947-5-5 page 15

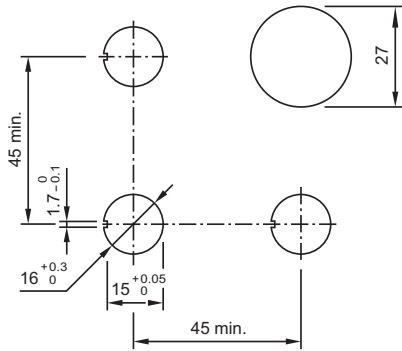

4 Indicator actuator 35 mm, flush mounting page 39 | Indicator actuator 30 - 70 mm, flush mounting page 39 | Illuminated pushbutton actuator 35 mm, flush mounting page 40 | Illuminated pushbutton actuator 55 - 70 mm, flush mounting page 41 | Keylock switch actuator 2 positions 45 mm, flush mounting page 42 | Keylock switch actuator 2 positions 55 mm, flush mounting page 43 | Keylock switch actuator 2 positions 70 mm, flush mounting page 45 | Keylock switch actuator 3 positions 45 mm, flush mounting page 47

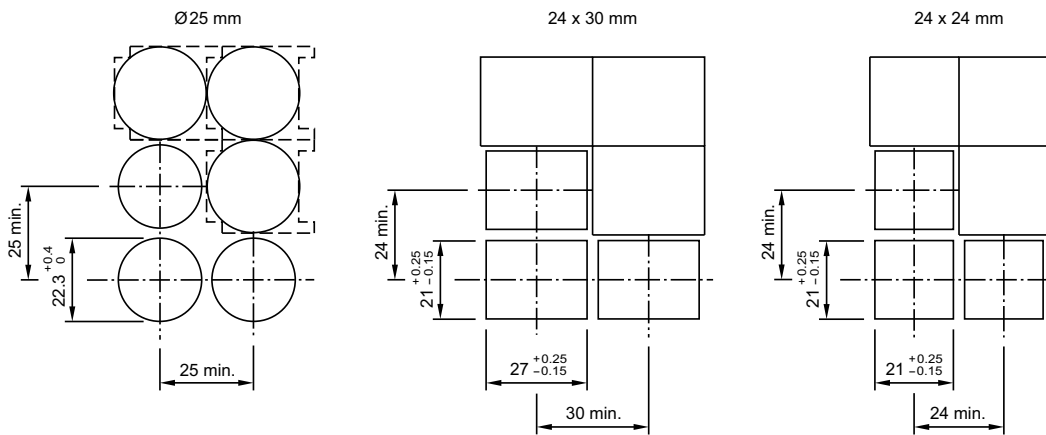

### 5 Indicator actuator 35 mm page 10 | Illuminated pushbutton actuator 35 mm page 11

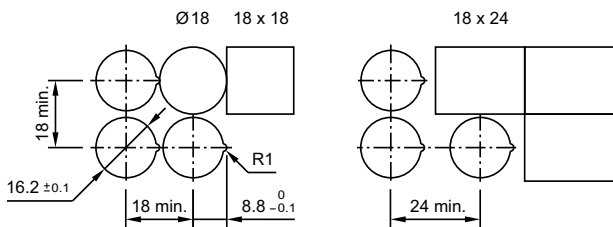

IP 40

### 6 Indicator actuator 35 mm page 10 | Illuminated pushbutton actuator 35 mm page 11

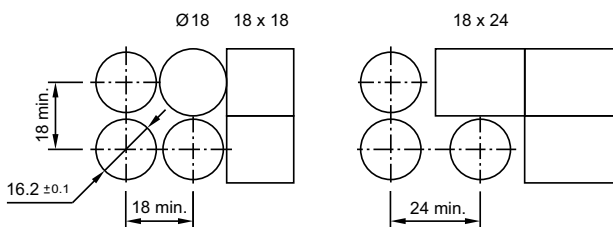

IP 65

7 Indicator actuator 30 - 70 mm page 10 | Illuminated pushbutton actuator 55 - 70 mm page 12 | Illuminated pushbutton actuator 55 - 70 mm, momentary, switch interlock system variants 1, 3 - 7 page 30 | Illuminated pushbutton actuator 55 - 70 mm, maintained, switch interlock system variant 2 page 31 | Release button actuator 55 - 70 mm, momentary, switch interlock system variants 4 - 7 page 32

(IP 40) Ø18 18 x 18

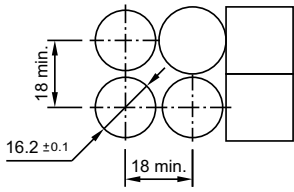

(IP 40) Ø24 24 x 24

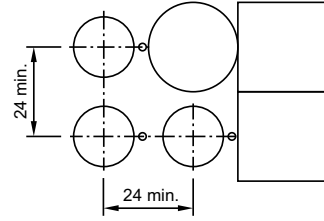

(IP 40) 18 x 24

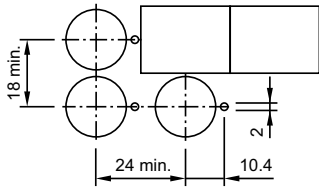

(IP 65) Ø24 24 x 24

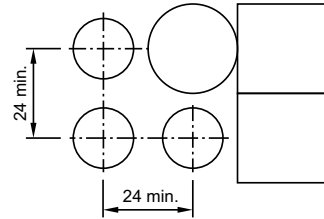

8 Mushroom-head pushbutton actuator 55 - 70 mm page 16

18 x 24 Ø24

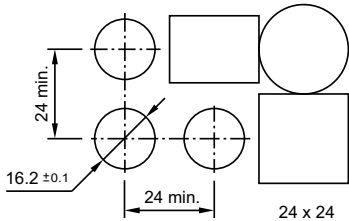

9 Keylock switch actuator 2 positions 45 mm page 17 | Keylock switch actuator 2 positions 55 mm page 18 | Keylock switch actuator 2 positions 70 mm page 20 | Keylock switch actuator 3 positions 45 mm page 22 | Keylock switch 2 positions actuator 55 - 70 mm, momentary, switch interlock system function 2 page 33 | Keylock switch actuator 2 positions 55 mm, maintained, switch interlock system functions 1 and 3 page 35 | Keylock switch 2 positions actuator 70 mm, maintained, switch interlock system functions 1 and 3 page 37

Ø18 18 x 18

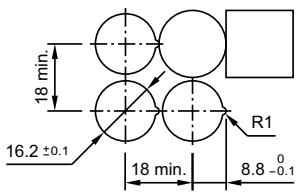

18 x 24

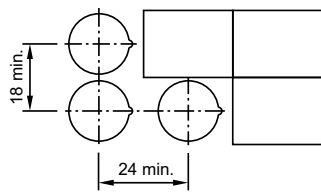

Ø24 24 x 24

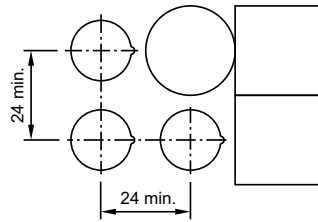

IP 40



10 Keylock switch actuator 2 positions 45 mm page 17 | Keylock switch actuator 2 positions 55 mm page 18 | Keylock switch actuator 2 positions 70 mm page 20 | Keylock switch actuator 3 positions 45 mm page 22 | Keylock switch 2 positions actuator 55 - 70 mm, momentary, switch interlock system function 2 page 33 | Keylock switch actuator 2 positions 55 mm, maintained, switch interlock system functions 1 and 3 page 35 | Keylock switch 2 positions actuator 70 mm, maintained, switch interlock system functions 1 and 3 page 37

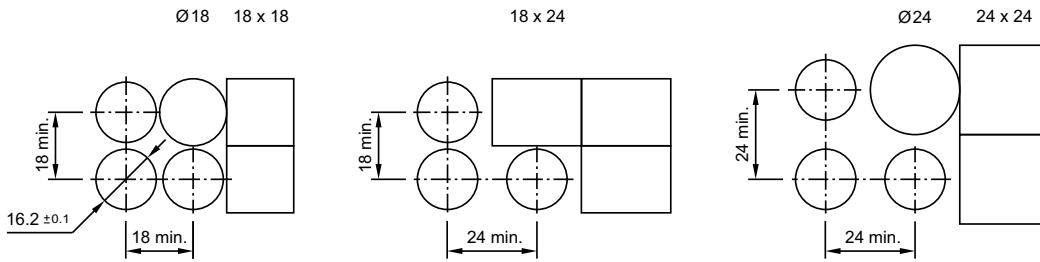

IP 65

11 Buzzer actuator 30 - 55 mm page 11

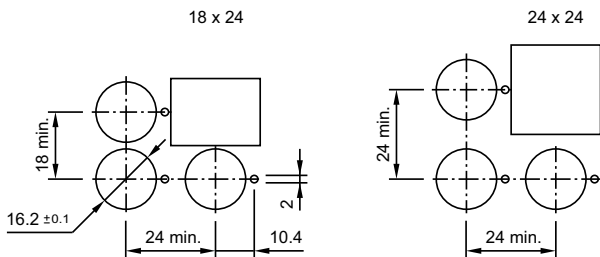

12 Buzzer actuator 30 - 55 mm, flush mounting page 40

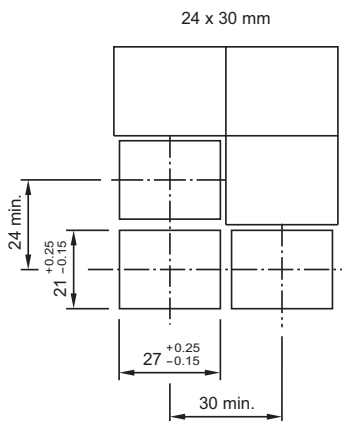

13 Illuminated push-pull pushbutton actuator 45 mm page 29

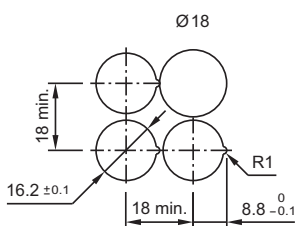

## 14 Stop pushbutton 55 - 70 mm page 13

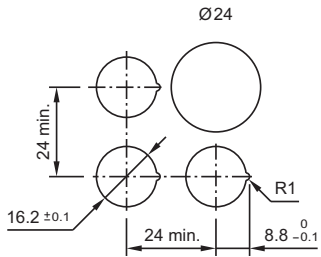

IP 40

## 15 Stop pushbutton 55 - 70 mm page 13

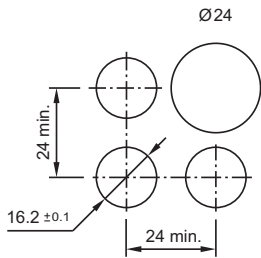

IP 65

## 16 Selector switch actuator 2 positions 45 mm, flush mounting page 48 | Selector switch actuator 2 positions 55 mm, flush mounting page 49 | Selector switch actuator 2 positions 70 mm, flush mounting page 51 | Selector switch actuator 3 positions 45 mm, flush mounting page 53

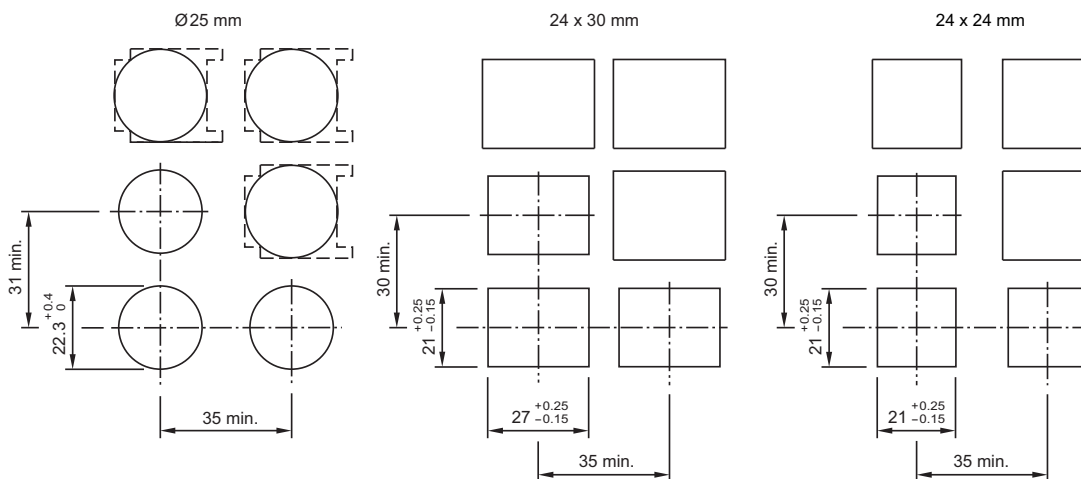

## Technical drawing

### 1 Protective cover Illuminated pusbutton | Key lock switch, flush mounting page 63

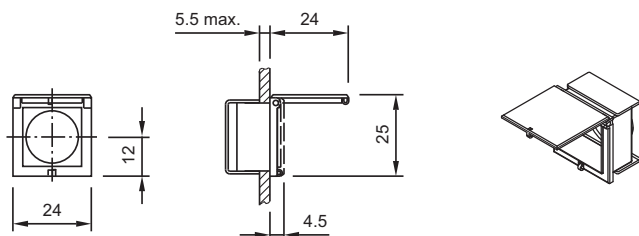

## 2 Protective cover illuminated pushbutton | Key lock switch, flush mounting page 63

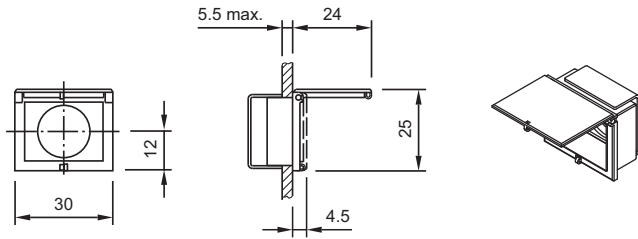

## 3 Emergency-stop pushbutton, foolproof EN IEC 60947-5-5 page 15

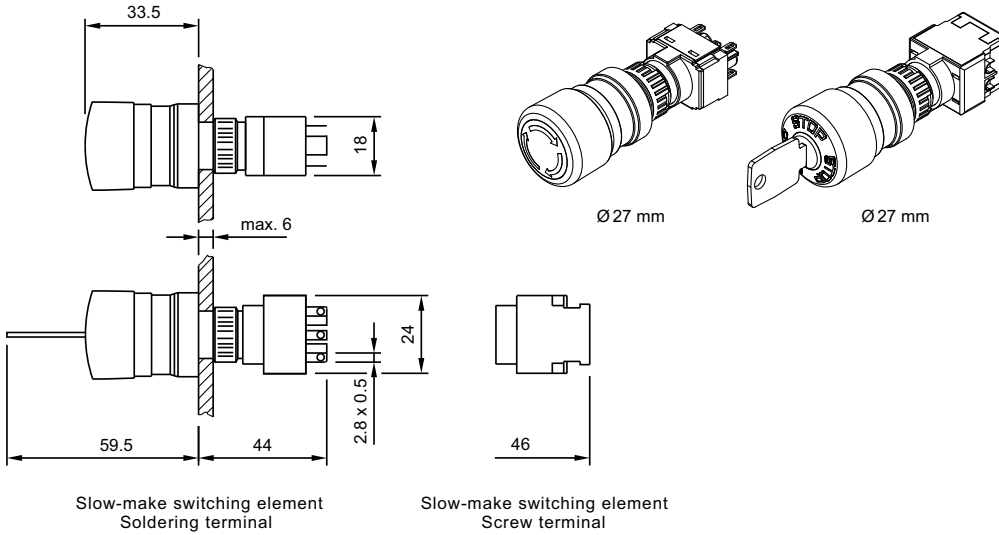

## 4 Illuminated pushbutton actuator 55 - 70 mm page 12 | Illuminated pushbutton actuator 55 - 70 mm, momentary, switch interlock system variants 1, 3 - 7 page 30 | Illuminated pushbutton actuator 55 - 70 mm, maintained, switch interlock system variant 2 page 31 | Release button actuator 55 - 70 mm, momentary, switch interlock system variants 4 - 7 page 32

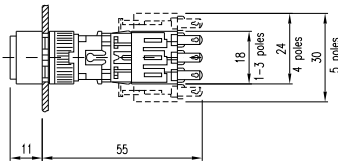

## 5 Indicator actuator 35 mm page 10 | Illuminated pushbutton actuator 35 mm page 11

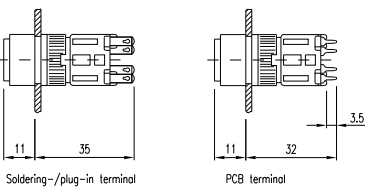

## 6 Mushroom-head pushbutton actuator 55 - 70 mm page 16

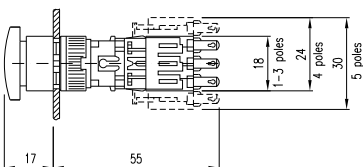

**7 Mushroom-head pushbutton actuator 55 - 70 mm page 16**

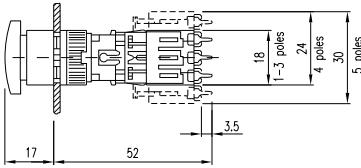

**8 Illuminated pushbutton actuator 55 - 70 mm page 12 | Illuminated pushbutton actuator 55 - 70 mm, momentary, switch interlock system variants 1, 3 - 7 page 30 | Illuminated pushbutton actuator 55 - 70 mm, maintained, switch interlock system variant 2 page 31 | Release button actuator 55 - 70 mm, momentary, switch interlock system variants 4 - 7 page 32**

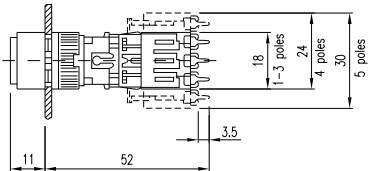

**9 Snap-action switching element page 67**

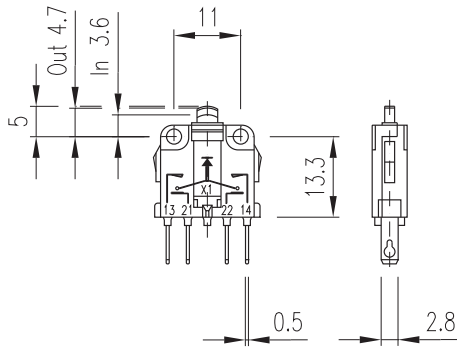

**10 Slow-make switching element for Stop pushbutton page 72**

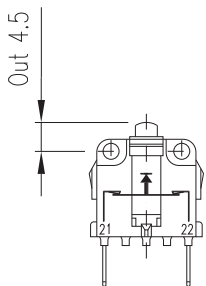

**11 Illuminated pushbutton actuator 55 - 70 mm page 12 | Illuminated pushbutton actuator 55 - 70 mm, momentary, switch interlock system variants 1, 3 - 7 page 30 | Illuminated pushbutton actuator 55 - 70 mm, maintained, switch interlock system variant 2 page 31 | Release button actuator 55 - 70 mm, momentary, switch interlock system variants 4 - 7 page 32**

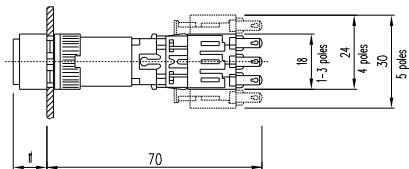

12 Illuminated pushbutton actuator 55 - 70 mm page 12 | Illuminated pushbutton actuator 55 - 70 mm, momentary, switch interlock system variants 1, 3 - 7 page 30 | Illuminated pushbutton actuator 55 - 70 mm, maintained, switch interlock system variant 2 page 31 | Release button actuator 55 - 70 mm, momentary, switch interlock system variants 4 - 7 page 32

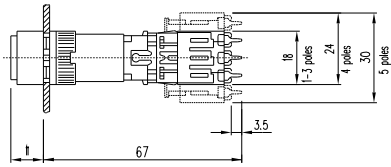

13 Mushroom-head pushbutton actuator 55 - 70 mm page 16

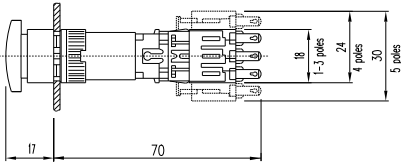

14 Mushroom-head pushbutton actuator 55 - 70 mm page 16

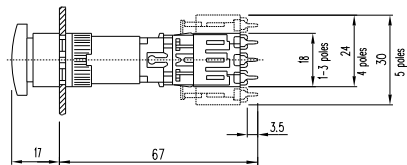

15 Indicator actuator 30 - 70 mm page 10

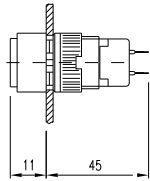

16 Indicator actuator 30 - 70 mm page 10 | Buzzer actuator 30 - 55 mm page 11

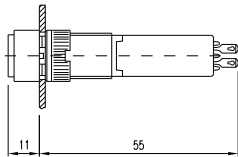

17 Indicator actuator 30 - 70 mm page 10

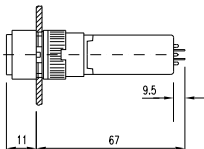

18 Indicator actuator 30 - 70 mm page 10 | Buzzer actuator 30 - 55 mm page 11

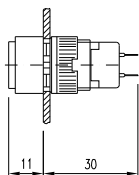

19 Indicator actuator 30 - 70 mm page 10

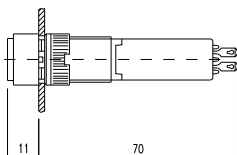

20 Keylock switch actuator 2 positions 55 mm page 18 | Keylock switch 2 positions actuator 55 - 70 mm, momentary, switch interlock system function 2 page 33 | Keylock switch actuator 2 positions 55 mm, maintained, switch interlock system functions 1 and 3 page 35

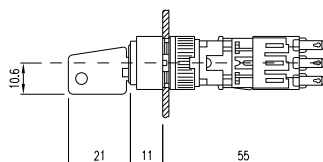

21 Selector switch actuator 2 positions 55 mm page 24

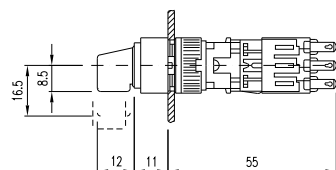

22 Keylock switch actuator 2 positions 45 mm page 17 | Keylock switch actuator 3 positions 45 mm page 22

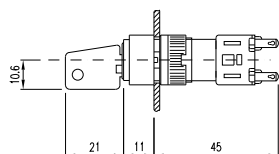

23 Selector switch actuator 2 positions 45 mm page 23 | Selector switch actuator 3 positions 45 mm page 28

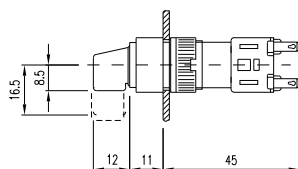

**24 Stop pushbutton 55 - 70 mm page 13**

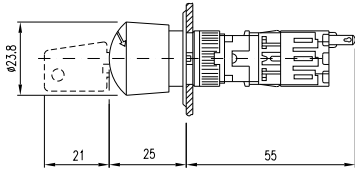

**25 Illuminated push-pull pushbutton actuator 45 mm page 29**

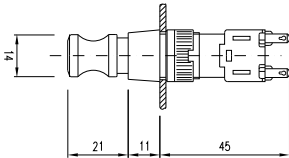

**26 Indicator actuator 30 - 70 mm page 10 | Buzzer actuator 30 - 55 mm page 11**

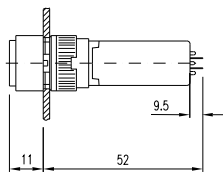

**27 Keylock switch actuator 2 positions 55 mm page 18 | Keylock switch 2 positions actuator 55 - 70 mm, momentary, switch interlock system function 2 page 33 | Keylock switch actuator 2 positions 55 mm, maintained, switch interlock system functions 1 and 3 page 35**

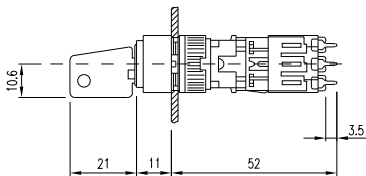

**28 Selector switch actuator 2 positions 55 mm page 24**

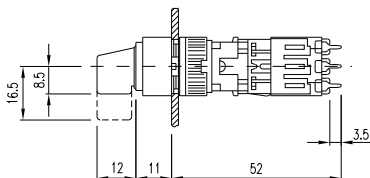

**29 Keylock switch actuator 2 positions 45 mm page 17 | Keylock switch actuator 3 positions 45 mm page 22**

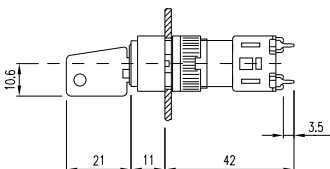

30 Selector switch actuator 2 positions 45 mm page 23 | Selector switch actuator 3 positions 45 mm page 28

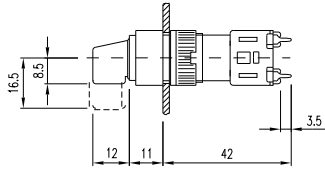

31 Stop pushbutton 55 - 70 mm page 13

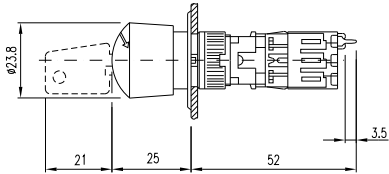

32 Illuminated push-pull pushbutton actuator 45 mm page 29

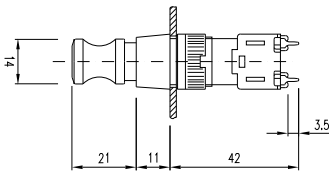

33 Selector switch actuator 2 positions 45 mm, flush mounting page 48 | Selector switch actuator 3 positions 45 mm, flush mounting page 53

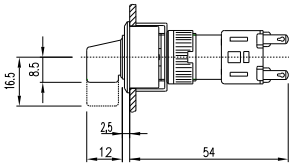

34 Selector switch actuator 2 positions 45 mm, flush mounting page 48 | Selector switch actuator 3 positions 45 mm, flush mounting page 53

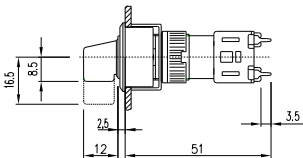

35 Selector switch actuator 2 positions 55 mm, flush mounting page 49

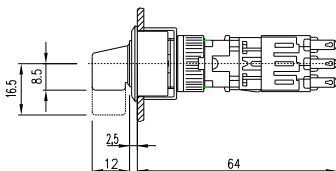



**36 Selector switch actuator 2 positions 55 mm, flush mounting** page 49

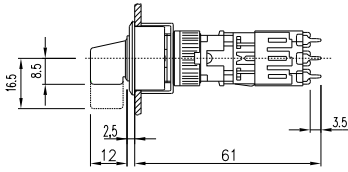

**37 Selector switch actuator 2 positions 70 mm, flush mounting** page 51

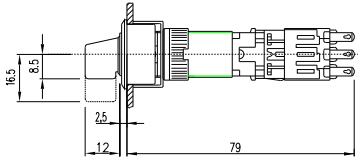

**38 Selector switch actuator 2 positions 70 mm, flush mounting** page 51

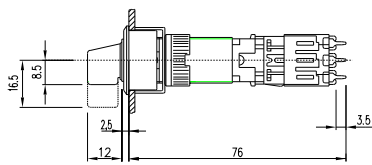

**39 Stop pushbutton 55 - 70 mm** page 13

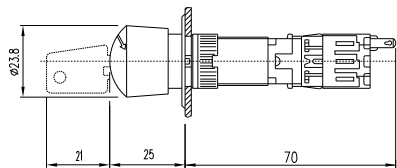

**40 Stop pushbutton 55 - 70 mm** page 13

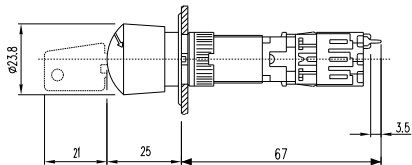

**41 Indicator actuator 35 mm, flush mounting** page 39 | **Illuminated pushbutton actuator 35 mm, flush mounting** page 40

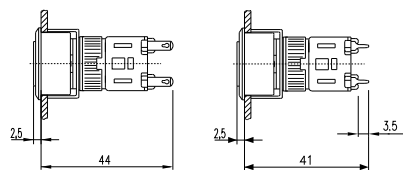

**42 Illuminated pushbutton actuator 55 - 70 mm, flush mounting** page 41

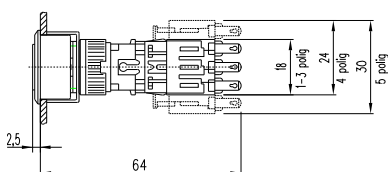

43 Illuminated pushbutton actuator 55 - 70 mm, flush mounting page 41

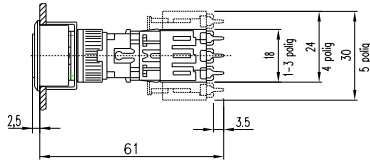

44 Illuminated pushbutton actuator 55 - 70 mm, flush mounting page 41

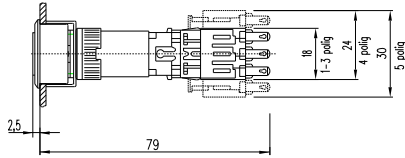

45 Illuminated pushbutton actuator 55 - 70 mm, flush mounting page 41

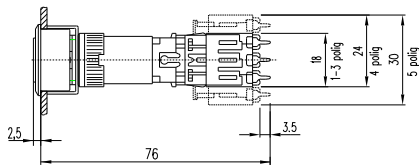

46 Indicator actuator 30 - 70 mm, flush mounting page 39 | Buzzer actuator 30 - 55 mm, flush mounting page 40

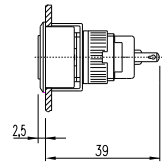

47 Indicator actuator 30 - 70 mm, flush mounting page 39 | Buzzer actuator 30 - 55 mm, flush mounting page 40

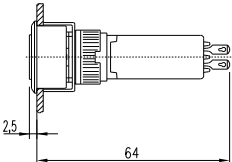

48 Indicator actuator 30 - 70 mm, flush mounting page 39 | Buzzer actuator 30 - 55 mm, flush mounting page 40

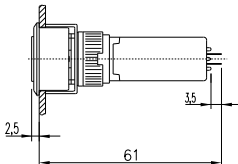

49 Indicator actuator 30 - 70 mm, flush mounting page 39

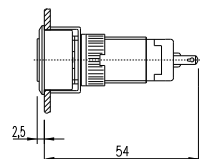

50 Indicator actuator 30 - 70 mm, flush mounting page 39

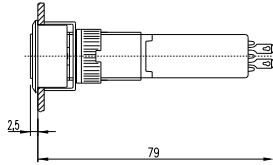

51 Indicator actuator 30 - 70 mm, flush mounting page 39

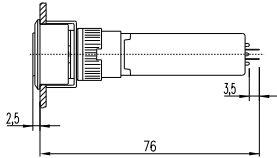

52 Keylock switch actuator 2 positions 70 mm page 20 | Keylock switch 2 positions actuator 55 - 70 mm, momentary, switch interlock system function 2 page 33 | Keylock switch 2 positions actuator 70 mm, maintained, switch interlock system functions 1 and 3 page 37

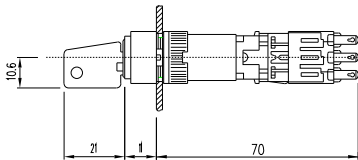

53 Keylock switch actuator 2 positions 70 mm page 20 | Keylock switch 2 positions actuator 55 - 70 mm, momentary, switch interlock system function 2 page 33 | Keylock switch 2 positions actuator 70 mm, maintained, switch interlock system functions 1 and 3 page 37

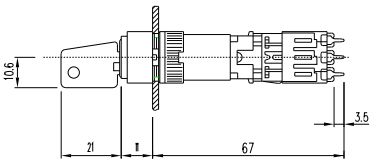

54 Selector switch actuator 2 positions 70 mm page 26

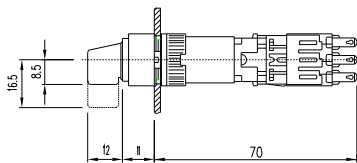

55 Selector switch actuator 2 positions 70 mm page 26

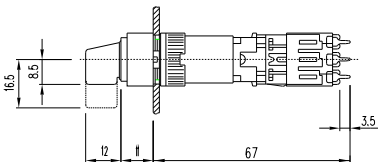

**56 Keylock switch actuator 2 positions 45 mm, flush mounting** page 42 | **Keylock switch actuator 3 positions 45 mm, flush mounting** page 47

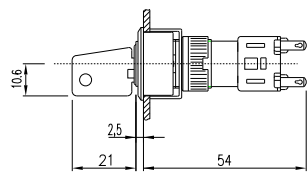

**57 Keylock switch actuator 2 positions 45 mm, flush mounting** page 42 | **Keylock switch actuator 3 positions 45 mm, flush mounting** page 47

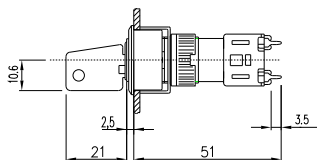

**58 Keylock switch actuator 2 positions 55 mm, flush mounting** page 43

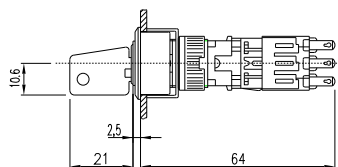

**59 Keylock switch actuator 2 positions 55 mm, flush mounting** page 43

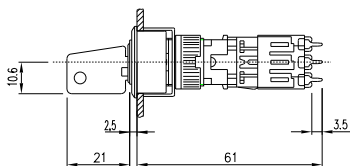

**60 Keylock switch actuator 2 positions 70 mm, flush mounting** page 45

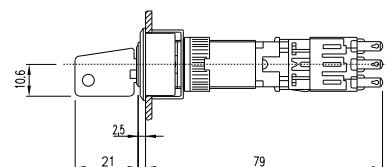

**61 Keylock switch actuator 2 positions 70 mm, flush mounting** page 45

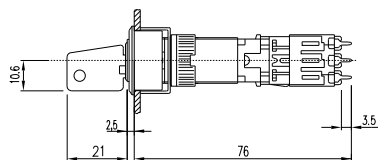

62 Protective cover for buttons 35 mm page 62 | Protective cover for buttons 55 - 70 mm page 63

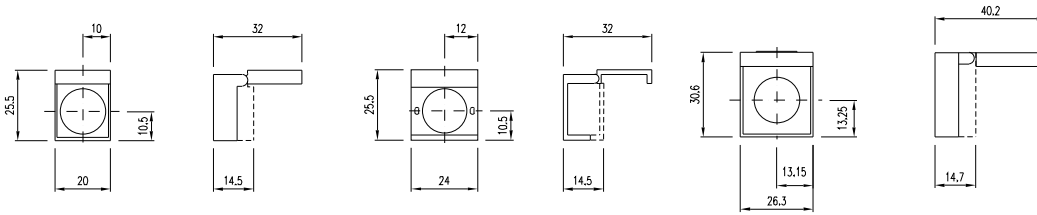

## Circuit drawing

1 Buzzer actuator 30 - 55 mm page 11 | Buzzer actuator 30 - 55 mm, flush mounting page 40

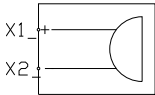

2 Indicator actuator 35 mm page 10 | Indicator actuator 30 - 70 mm page 10 | Indicator actuator 35 mm, flush mounting page 39 | Indicator actuator 30 - 70 mm, flush mounting page 39 | Lamp element block for 35 mm page 66

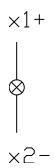

3 Lamp element block for 35 mm page 66

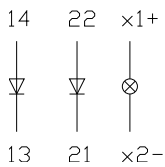

4 Lamp element block for 35 mm page 66

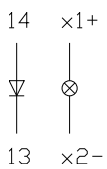

5 Mushroom-head pushbutton actuator 55 - 70 mm page 16

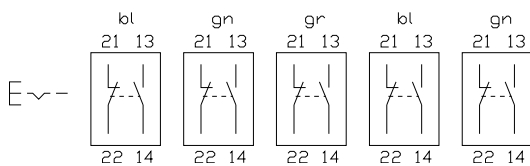

6 Illuminated pushbutton actuator 55 - 70 mm page 12 | Illuminated pushbutton actuator 55 - 70 mm, maintained, switch interlock system variant 2 page 31 | Illuminated pushbutton actuator 55 - 70 mm, flush mounting page 41

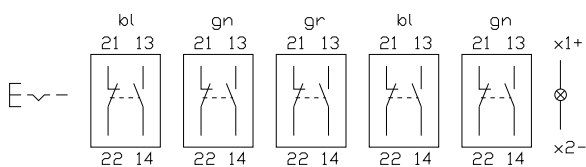

**7 Mushroom-head pushbutton actuator 55 - 70 mm page 16**

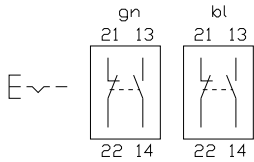

**8 Illuminated pushbutton actuator 55 - 70 mm page 12 | Illuminated pushbutton actuator 55 - 70 mm, maintained, switch interlock system variant 2 page 31 | Illuminated pushbutton actuator 55 - 70 mm, flush mounting page 41**

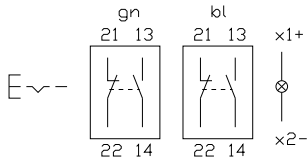

**9 Mushroom-head pushbutton actuator 55 - 70 mm page 16**

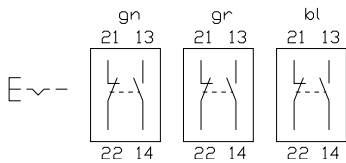

**10 Mushroom-head pushbutton actuator 55 - 70 mm page 16**

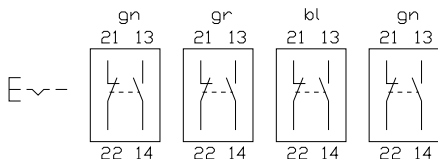

**11 Illuminated pushbutton actuator 55 - 70 mm page 12 | Illuminated pushbutton actuator 55 - 70 mm, maintained, switch interlock system variant 2 page 31 | Illuminated pushbutton actuator 55 - 70 mm, flush mounting page 41**

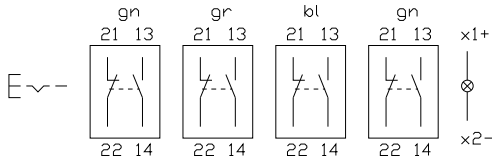

**12 Illuminated pushbutton actuator 55 - 70 mm page 12 | Illuminated pushbutton actuator 55 - 70 mm, maintained, switch interlock system variant 2 page 31 | Illuminated pushbutton actuator 55 - 70 mm, flush mounting page 41**

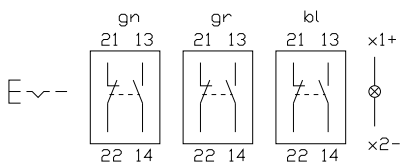

**13 Mushroom-head pushbutton actuator 55 - 70 mm page 16**

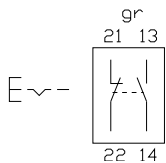

**14 Illuminated pushbutton actuator 55 - 70 mm page 12 | Illuminated pushbutton actuator 55 - 70 mm, maintained, switch interlock system variant 2 page 31 | Illuminated pushbutton actuator 55 - 70 mm, flush mounting page 41**

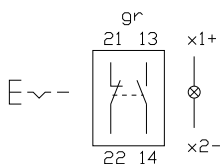

15 Illuminated pushbutton actuator 35 mm page 11 | Illuminated pushbutton actuator 35 mm, flush mounting page 40

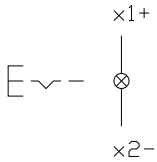

16 Selector switch actuator 3 positions 45 mm page 28 | Selector switch actuator 3 positions 45 mm, flush mounting page 53

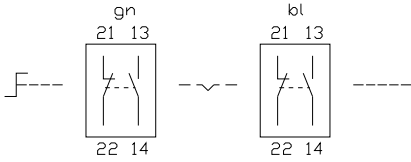

17 Selector switch actuator 3 positions 45 mm page 28 | Selector switch actuator 3 positions 45 mm, flush mounting page 53

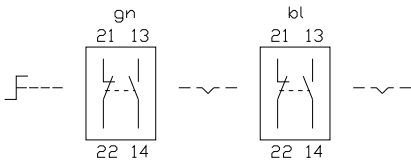

18 Selector switch actuator 3 positions 45 mm page 28 | Selector switch actuator 3 positions 45 mm, flush mounting page 53

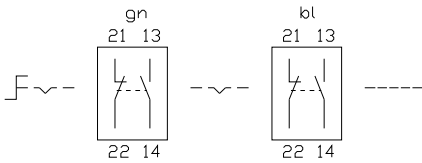

19 Selector switch actuator 3 positions 45 mm page 28 | Selector switch actuator 3 positions 45 mm, flush mounting page 53

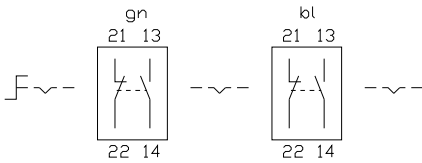

20 Selector switch actuator 2 positions 45 mm page 23 | Selector switch actuator 2 positions 45 mm, flush mounting page 48

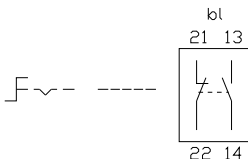

21 Selector switch actuator 2 positions 55 mm page 24 | Selector switch actuator 2 positions 70 mm page 26 | Selector switch actuator 2 positions 55 mm, flush mounting page 49 | Selector switch actuator 2 positions 70 mm, flush mounting page 51

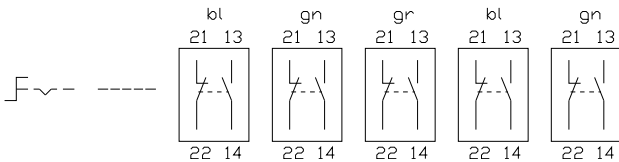

22 Selector switch actuator 2 positions 45 mm page 23 | Selector switch actuator 2 positions 55 mm page 24 | Selector switch actuator 2 positions 70 mm page 26 | Selector switch actuator 2 positions 45 mm, flush mounting page 48 | Selector switch actuator 2 positions 55 mm, flush mounting page 49 | Selector switch actuator 2 positions 70 mm, flush mounting page 51

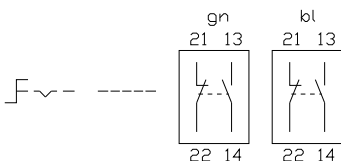

**23 Selector switch actuator 2 positions 55 mm page 24 | Selector switch actuator 2 positions 70 mm page 26 | Selector switch actuator 2 positions 55 mm, flush mounting page 49 | Selector switch actuator 2 positions 70 mm, flush mounting page 51**

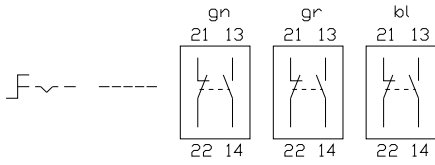

**24 Selector switch actuator 2 positions 55 mm page 24 | Selector switch actuator 2 positions 70 mm page 26 | Selector switch actuator 2 positions 55 mm, flush mounting page 49 | Selector switch actuator 2 positions 70 mm, flush mounting page 51**

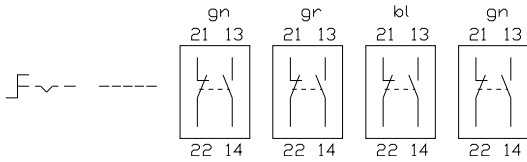

**25 Selector switch actuator 2 positions 55 mm page 24 | Selector switch actuator 2 positions 70 mm page 26 | Selector switch actuator 2 positions 55 mm, flush mounting page 49 | Selector switch actuator 2 positions 70 mm, flush mounting page 51**

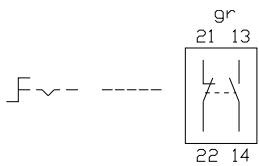

**26 Selector switch actuator 2 positions 45 mm page 23 | Selector switch actuator 2 positions 45 mm, flush mounting page 48**

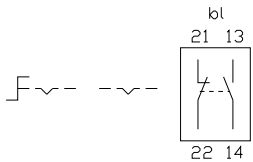

**27 Selector switch actuator 2 positions 55 mm page 24 | Selector switch actuator 2 positions 70 mm page 26 | Selector switch actuator 2 positions 55 mm, flush mounting page 49 | Selector switch actuator 2 positions 70 mm, flush mounting page 51**

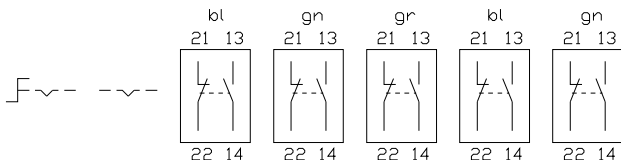

**28 Selector switch actuator 2 positions 45 mm page 23 | Selector switch actuator 2 positions 55 mm page 24 | Selector switch actuator 2 positions 70 mm page 26 | Selector switch actuator 2 positions 45 mm, flush mounting page 48 | Selector switch actuator 2 positions 55 mm, flush mounting page 49 | Selector switch actuator 2 positions 70 mm, flush mounting page 51**

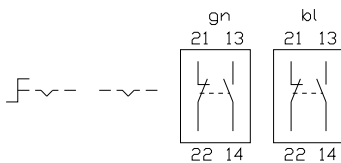

**29 Selector switch actuator 2 positions 55 mm page 24 | Selector switch actuator 2 positions 70 mm page 26 | Selector switch actuator 2 positions 55 mm, flush mounting page 49 | Selector switch actuator 2 positions 70 mm, flush mounting page 51**

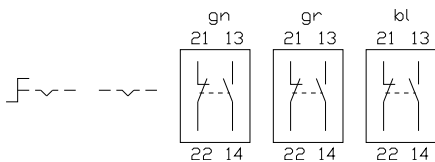



**30 Selector switch actuator 2 positions 55 mm** page 24 | **Selector switch actuator 2 positions 70 mm** page 26 | **Selector switch actuator 2 positions 55 mm, flush mounting** page 49 | **Selector switch actuator 2 positions 70 mm, flush mounting** page 51

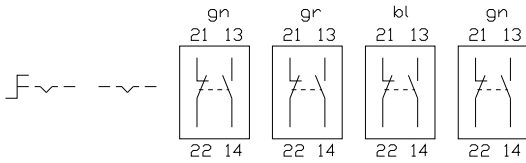

**31 Selector switch actuator 2 positions 55 mm** page 24 | **Selector switch actuator 2 positions 70 mm** page 26 | **Selector switch actuator 2 positions 55 mm, flush mounting** page 49 | **Selector switch actuator 2 positions 70 mm, flush mounting** page 51

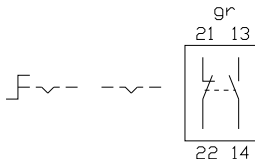

**32 Illuminated pushbutton actuator 35 mm** page 11 | **Illuminated pushbutton actuator 35 mm, flush mounting** page 40

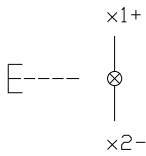

**33 Snap-action switching element block for 35 mm** page 66

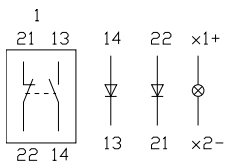

**34 Snap-action switching element block for 35 mm** page 66

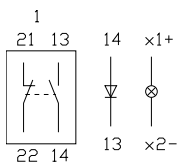

**35 Snap-action switching element block for 35 mm** page 66

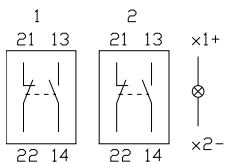

**36 Snap-action switching element block for 35 mm** page 66

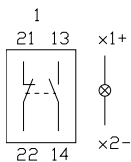

**37 Keylock switch actuator 3 positions 45 mm** page 22 | **Keylock switch actuator 3 positions 45 mm, flush mounting** page 47

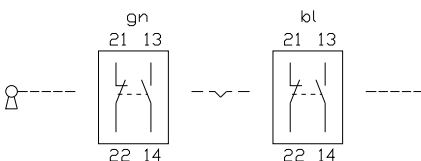

**38 Keylock switch actuator 3 positions 45 mm page 22 | Keylock switch actuator 3 positions 45 mm, flush mounting page 47**

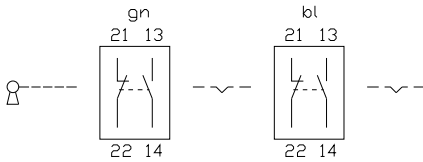

**39 Keylock switch actuator 3 positions 45 mm page 22 | Keylock switch actuator 3 positions 45 mm, flush mounting page 47**

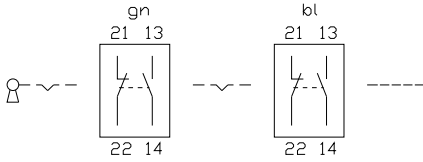

**40 Keylock switch actuator 3 positions 45 mm page 22 | Keylock switch actuator 3 positions 45 mm, flush mounting page 47**

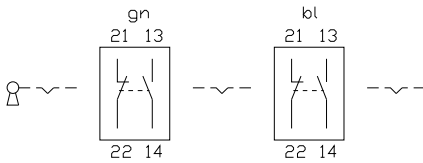

**41 Keylock switch actuator 2 positions 45 mm page 17 | Keylock switch actuator 2 positions 45 mm, flush mounting page 42**

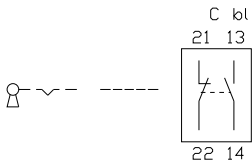

**42 Keylock switch actuator 2 positions 55 mm page 18 | Keylock switch actuator 2 positions 70 mm page 20 | Keylock switch 2 positions actuator 55 - 70 mm, momentary, switch interlock system function 2 page 33 | Keylock switch actuator 2 positions 55 mm, flush mounting page 43 | Keylock switch actuator 2 positions 70 mm, flush mounting page 45**

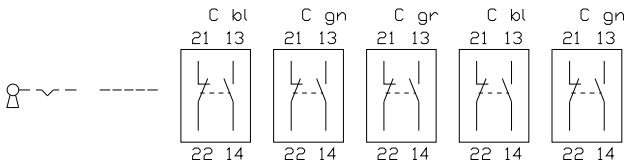

**43 Keylock switch actuator 2 positions 45 mm page 17 | Keylock switch actuator 2 positions 55 mm page 18 | Keylock switch actuator 2 positions 70 mm page 20 | Keylock switch 2 positions actuator 55 - 70 mm, momentary, switch interlock system function 2 page 33 | Keylock switch actuator 2 positions 45 mm, flush mounting page 42 | Keylock switch actuator 2 positions 55 mm, flush mounting page 43 | Keylock switch actuator 2 positions 70 mm, flush mounting page 45**

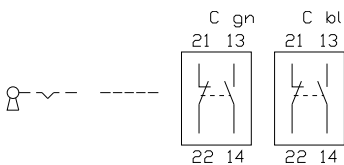

**44 Keylock switch actuator 2 positions 55 mm page 18 | Keylock switch actuator 2 positions 70 mm page 20 | Keylock switch 2 positions actuator 55 - 70 mm, momentary, switch interlock system function 2 page 33 | Keylock switch actuator 2 positions 55 mm, flush mounting page 43 | Keylock switch actuator 2 positions 70 mm, flush mounting page 45**

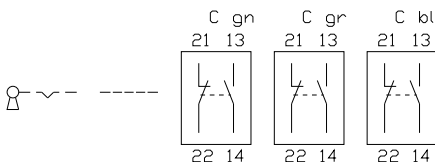

45 Keylock switch actuator 2 positions 55 mm page 18 | Keylock switch actuator 2 positions 70 mm page 20 | Keylock switch 2 positions actuator 55 - 70 mm, momentary, switch interlock system function 2 page 33 | Keylock switch actuator 2 positions 55 mm, flush mounting page 43 | Keylock switch actuator 2 positions 70 mm, flush mounting page 45

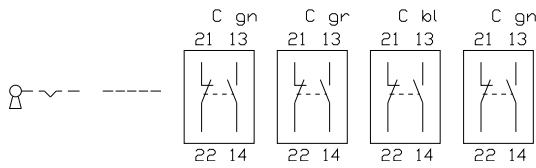

46 Keylock switch actuator 2 positions 55 mm page 18 | Keylock switch actuator 2 positions 70 mm page 20 | Keylock switch 2 positions actuator 55 - 70 mm, momentary, switch interlock system function 2 page 33 | Keylock switch actuator 2 positions 55 mm, flush mounting page 43 | Keylock switch actuator 2 positions 70 mm, flush mounting page 45

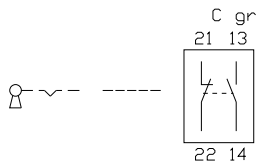

47 Keylock switch actuator 2 positions 45 mm page 17 | Keylock switch actuator 2 positions 45 mm, flush mounting page 42

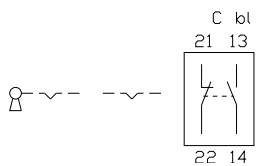

48 Keylock switch actuator 2 positions 55 mm page 18 | Keylock switch actuator 2 positions 70 mm page 20 | Keylock switch actuator 2 positions 55 mm, maintained, switch interlock system functions 1 and 3 page 35 | Keylock switch 2 positions actuator 70 mm, maintained, switch interlock system functions 1 and 3 page 37 | Keylock switch actuator 2 positions 55 mm, flush mounting page 43 | Keylock switch actuator 2 positions 70 mm, flush mounting page 45

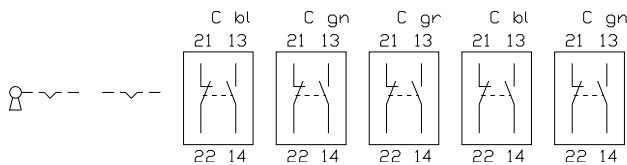

49 Keylock switch actuator 2 positions 45 mm page 17 | Keylock switch actuator 2 positions 55 mm page 18 | Keylock switch actuator 2 positions 70 mm page 20 | Keylock switch actuator 2 positions 55 mm, maintained, switch interlock system functions 1 and 3 page 35 | Keylock switch 2 positions actuator 70 mm, maintained, switch interlock system functions 1 and 3 page 37 | Keylock switch actuator 2 positions 45 mm, flush mounting page 42 | Keylock switch actuator 2 positions 55 mm, flush mounting page 43 | Keylock switch actuator 2 positions 70 mm, flush mounting page 45

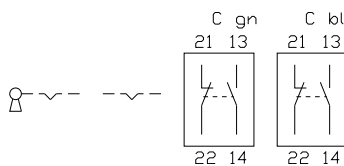

50 Keylock switch actuator 2 positions 55 mm page 18 | Keylock switch actuator 2 positions 70 mm page 20 | Keylock switch actuator 2 positions 55 mm, maintained, switch interlock system functions 1 and 3 page 35 | Keylock switch 2 positions actuator 70 mm, maintained, switch interlock system functions 1 and 3 page 37 | Keylock switch actuator 2 positions 55 mm, flush mounting page 43 | Keylock switch actuator 2 positions 70 mm, flush mounting page 45

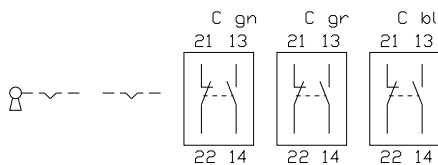

51 Keylock switch actuator 2 positions 55 mm page 18 | Keylock switch actuator 2 positions 70 mm page 20 | Keylock switch actuator 2 positions 55 mm, maintained, switch interlock system functions 1 and 3 page 35 | Keylock switch 2 positions actuator 70 mm, maintained, switch interlock system functions 1 and 3 page 37 | Keylock switch actuator 2 positions 55 mm, flush mounting page 43 | Keylock switch actuator 2 positions 70 mm, flush mounting page 45

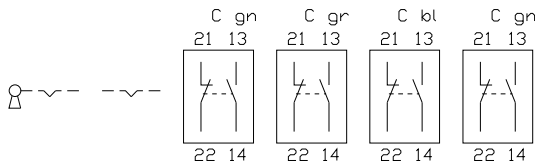

52 Keylock switch actuator 2 positions 55 mm page 18 | Keylock switch actuator 2 positions 70 mm page 20 | Keylock switch actuator 2 positions 55 mm, maintained, switch interlock system functions 1 and 3 page 35 | Keylock switch 2 positions actuator 70 mm, maintained, switch interlock system functions 1 and 3 page 37 | Keylock switch actuator 2 positions 55 mm, flush mounting page 43 | Keylock switch actuator 2 positions 70 mm, flush mounting page 45

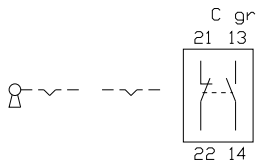

53 Emergency-stop pushbutton, foolproof EN IEC 60947-5-5 page 15

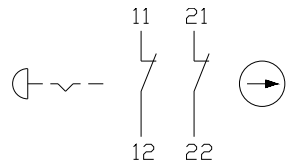

54 Emergency-stop pushbutton, foolproof EN IEC 60947-5-5 page 15

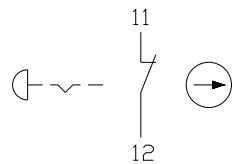

55 Stop pushbutton 55 - 70 mm page 13

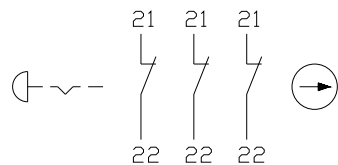

56 Stop pushbutton 55 - 70 mm page 13

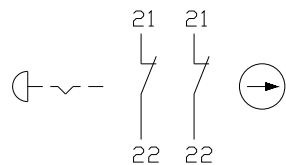

57 Stop pushbutton 55 - 70 mm page 13

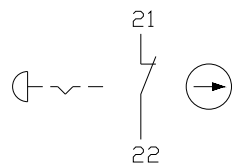

**58 Emergency-stop pushbutton, foolproof EN IEC 60947-5-5 page 15**

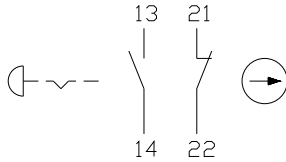

**59 Illuminated push-pull pushbutton actuator 45 mm page 29**

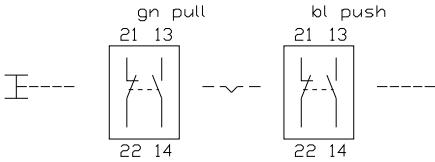

**60 Illuminated pushbutton actuator 55 - 70 mm, momentary, switch interlock system variants 1, 3 - 7 page 30 | Release button actuator 55 - 70 mm, momentary, switch interlock system variants 4 - 7 page 32**

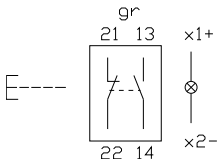

**61 Illuminated pushbutton actuator 55 - 70 mm, momentary, switch interlock system variants 1, 3 - 7 page 30 | Release button actuator 55 - 70 mm, momentary, switch interlock system variants 4 - 7 page 32**

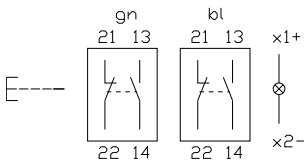

**62 Illuminated pushbutton actuator 55 - 70 mm, momentary, switch interlock system variants 1, 3 - 7 page 30 | Release button actuator 55 - 70 mm, momentary, switch interlock system variants 4 - 7 page 32**

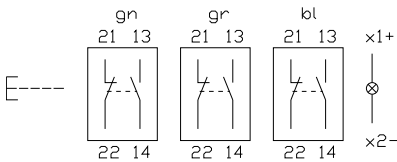

**63 Illuminated pushbutton actuator 55 - 70 mm, momentary, switch interlock system variants 1, 3 - 7 page 30 | Release button actuator 55 - 70 mm, momentary, switch interlock system variants 4 - 7 page 32**

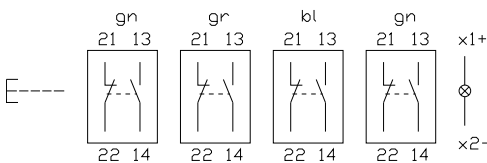

**64 Illuminated pushbutton actuator 55 - 70 mm, momentary, switch interlock system variants 1, 3 - 7 page 30 | Release button actuator 55 - 70 mm, momentary, switch interlock system variants 4 - 7 page 32**

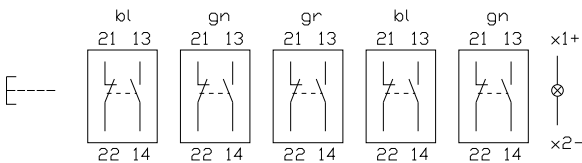

# Index from Typ-Nr.

Typ-Nr.	Page	Typ-Nr.	Page	Typ-Nr.	Page
10-1106.1369	69	200-.265-00	61	200-2002-03	60
10-1109.1329	69	200-.275-00	61	200-2002-04	60
10-1112.1279	69	200-.604-00	60	200-2003-01	59
10-1116.1229	69	200-.704-00	60	200-2004-00	58
10-1119.1199	69	200-.804-00	60	200-2004-00	59
10-1307.1369	69	200-.904-00	60	200-2006-00	65
10-1310.1319	69	200-0000-00	61	200-2006-W0	65
10-1313.1249	69	200-0000-00	62	200-3000-00	61
10-1316.1209	69	200-0000-W0	61	200-3001-00	58
10-1319.1199	69	200-0001-00	58	200-3001-01	58
10-2106.3142	70	200-0001-01	58	200-3002-00	59
10-2106.3144	70	200-0002-00	59	200-3002-02	59
10-2106.3145	70	200-0002-02	59	200-3002-03	60
10-2106.3146	70	200-0002-03	60	200-3002-04	60
10-2106.3149	70	200-0002-04	60	200-3003-01	59
10-2109.1062	70	200-0003-01	59	200-3004-00	58
10-2109.1064	70	200-0004-00	58	200-3004-00	59
10-2109.1065	70	200-0004-00	59	200-3006-00	65
10-2109.1066	70	200-0006-W0	65	200-3007-00	64
10-2109.1069	70	200-0008-W0	63	200-3009-W0	63
10-2112.1062	70	200-1000-00	61	200-3110-00	55
10-2112.1064	70	200-1000-00	61	200-3120-00	55
10-2112.1065	70	200-1001-00	58	200-3140-00	55
10-2112.1066	70	200-1001-01	58	200-3150-00	55
10-2112.1069	70	200-1002-00	59	200-3160-00	55
10-2113.1062	70	200-1002-02	59	200-3170-00	55
10-2113.1064	70	200-1002-03	60	200-3180-00	57
10-2113.1065	70	200-1002-04	60	200-3190-00	57
10-2113.1066	70	200-1003-01	59	200-3210-00	56
10-2113.1069	70	200-1004-00	58	200-3220-00	56
10-2119.1042	70	200-1004-00	59	200-3240-00	56
10-2119.1044	70	200-1006-00	65	200-3250-00	56
10-2119.1045	70	200-1007-00	64	200-3260-00	56
10-2119.1046	70	200-1110-00	55	200-3270-00	56
10-2119.1049	70	200-1120-00	55	200-4000-00	61
10-2J06.3142	70	200-1140-00	55	200-4001-00	58
10-2J06.3144	70	200-1150-00	55	200-4001-01	58
10-2J06.3145	70	200-1160-00	55	200-4002-00	59
10-2J06.3146	70	200-1170-00	55	200-4002-02	59
10-2J06.3149	70	200-1180-00	57	200-4002-03	60
10-2J09.1062	70	200-1190-00	57	200-4002-04	60
10-2J09.1064	70	200-1210-00	56	200-4003-01	59
10-2J09.1065	70	200-1220-00	56	200-4004-00	58
10-2J09.1066	70	200-1240-00	56	200-4004-00	59
10-2J09.1069	70	200-1250-00	56	200-4006-00	65
10-2J12.1062	70	200-1260-00	56	200-4006-W0	65
10-2J12.1064	70	200-1270-00	56	200-4008-00	62
10-2J12.1065	70	200-1300-01	72	200-4008-00	63
10-2J12.1066	70	200-1300-02	72	200-4008-W0	62
10-2J12.1069	70	200-1300-03	72	200-4400-V0	62
10-2J13.1062	70	200-1300-04	72	200-4408-V0	63
10-2J13.1064	70	200-1300-08	72	200-5000-00	61
10-2J13.1065	70	200-1300-W1	72	200-5000-00	62
10-2J13.1066	70	200-1300-W2	72	200-5001-00	58
10-2J13.1069	70	200-1300-W3	72	200-5001-01	58
10-2J19.1042	70	200-1300-W4	72	200-5002-00	59
10-2J19.1044	70	200-1300-W8	72	200-5002-02	59
10-2J19.1045	70	200-2000-00	61	200-5002-03	60
10-2J19.1046	70	200-2000-00	61	200-5002-04	60
10-2J19.1049	70	200-2001-00	58	200-5003-01	59
200-.225-00	61	200-2001-01	58	200-5004-00	58
200-.245-00	61	200-2002-00	59	200-5004-00	59
200-.255-00	61	200-2002-02	59	200-5006-00	65

# Index from Typ-Nr.

Typ-Nr.	Page	Typ-Nr.	Page	Typ-Nr.	Page
200-5007-00	64	200-7180-00	57	200-9210-W0	56
200-5009-W0	63	200-7180-W0	57	200-9220-00	56
200-5110-00	55	200-7190-00	57	200-9220-W0	56
200-5120-00	55	200-7190-W0	57	200-9240-00	56
200-5140-00	55	200-7210-00	56	200-9240-W0	56
200-5150-00	55	200-7210-W0	56	200-9250-00	56
200-5160-00	55	200-7220-00	56	200-9250-W0	56
200-5170-00	55	200-7220-W0	56	200-9260-00	56
200-5180-00	57	200-7240-00	56	200-9260-W0	56
200-5190-00	57	200-7240-W0	56	200-9270-00	56
200-5210-00	56	200-7250-00	56	200-9270-W0	56
200-5220-00	56	200-7250-W0	56	200-9320-00	57
200-5240-00	56	200-7260-00	56	200-9340-00	57
200-5250-00	56	200-7260-W0	56	200-9370-00	57
200-5260-00	56	200-7270-00	56	200-9390-00	57
200-5270-00	56	200-7270-W0	56	201-0400-00	67
200-5320-00	57	200-7320-00	57	201-0500-00	67
200-5340-00	57	200-7340-00	57	201-0800-00	67
200-5370-00	57	200-7370-00	57	202-0600-00	66
200-5390-00	57	200-7390-00	57	211+0800-00	72
200-6000-00	61	200-8000-00	61	212-0100-00	71
200-6000-00	62	200-8000-W0	61	213-0100-00	71
200-6001-00	58	200-8001-00	58	214-0100-0P	71
200-6001-01	58	200-8001-01	58	221-0800-0P	67
200-6002-00	59	200-8002-00	59	222-0100-0P	71
200-6002-02	59	200-8002-02	59	231+0800-0P	72
200-6002-03	60	200-8002-03	60	240-2001-00	65
200-6002-04	60	200-8002-04	60	240-3001-00	65
200-6003-01	59	200-8003-01	59	240-4001-00	65
200-6004-00	58	200-8004-00	58	260-0001-00	73
200-6004-00	59	200-8004-00	59	260-0002-00	73
200-6006-00	65	200-8009-W0	64	260-0002-00	73
200-6006-W0	65	200-8400-V0	62	260-0003-00	73
200-6008-00	62	200-9000-00	61	260-0003-00	73
200-6008-00	63	200-9000-00	62	260-0005-00	73
200-6008-W0	62	200-9000-W0	61	260-0010-00	68
200-6400-V0	62	200-9001-00	58	260-0020-00	73
200-6400-V0	62	200-9001-01	58	260-0021-00	73
200-6408-V0	63	200-9002-00	59	260-8000-00	67
200-7000-00	61	200-9002-02	59	260-9000-00	67
200-7000-W0	61	200-9002-03	60	270-0000-00	67
200-7001-00	58	200-9002-04	60	270-0000-0P	67
200-7001-01	58	200-9003-01	59	270-1000-00	68
200-7002-00	59	200-9004-00	58	270-2000-00	67
200-7002-02	59	200-9004-00	59	270-3000-00	67
200-7002-03	60	200-9009-W0	64	280-0000-00	68
200-7002-04	60	200-9110-00	55	280-0001-00	69
200-7003-01	59	200-9110-W0	55	280-0002-00	69
200-7004-00	58	200-9120-00	55	280-0003-00	69
200-7004-00	59	200-9120-W0	55	280-0004-00	69
200-7009-W0	64	200-9140-00	55	280-0010-00	69
200-7110-00	55	200-9140-W0	55	280-0100-00	68
200-7110-W0	55	200-9150-00	55	280-0200-00	68
200-7120-00	55	200-9150-W0	55	280-1100-00	68
200-7120-W0	55	200-9160-00	55	280-1110-00	68
200-7140-00	55	200-9160-W0	55	280-1200-00	68
200-7140-W0	55	200-9170-00	55	280-1210-00	68
200-7150-00	55	200-9170-W0	55	280-2100-00	68
200-7150-W0	55	200-9180-00	57	280-2200-00	68
200-7160-00	55	200-9180-W0	57	280-3100-00	68
200-7160-W0	55	200-9190-00	57	280-3200-00	68
200-7170-00	55	200-9190-W0	57	300-0001-00	73
200-7170-W0	55	200-9210-00	56	300-0002-00	73

# Index from Typ-Nr.

Typ-Nr.	Page	Typ-Nr.	Page	Typ-Nr.	Page
300-0003-00	73	600-5180-00	54	712-700-WP	53
300-0004-00	74	600-5190-00	54	722-401-00	22
300-0005-00	74	600-5210-00	54	722-401-00	47
300-0006-00	74	600-5220-00	54	722-401-0P	22
300-0010-00	71	600-5240-00	54	722-401-0P	47
300-0017-00	72	600-5250-00	54	722-401-W0	22
300-0020-00	71	600-5260-00	54	722-401-W0	47
300-0030-00	71	600-5270-00	54	722-401-WP	22
300-0050-00	71	600-6000-00	11	722-401-WP	47
300-0105-00	71	600-6000-00	40	722-700-00	28
300-0110-00	71	600-6000-W0	11	722-700-00	53
300-0115-00	71	600-6000-W0	40	722-700-0P	28
300-0120-00	71	601-0000-00	66	722-700-0P	53
551-8000-W0	15	601-0000-0P	66	722-700-W0	28
552-8000-W0	15	602-0000-00	66	722-700-W0	53
553-8000-W0	15	602-0000-0P	66	722-700-WP	28
561-8101-W0	15	606-0000-00	66	722-700-WP	53
562-8101-W0	15	606-0000-0P	66	732-401-00	22
563-8101-W0	15	607-0000-00	66	732-401-00	47
600-0000-00	66	607-0000-0P	66	732-401-0P	22
600-0000-0P	66	608-0000-00	66	732-401-0P	47
600-1110-00	54	608-0000-0P	66	732-401-W0	22
600-1120-00	54	609-0000-00	66	732-401-W0	47
600-1140-00	54	609-0000-0P	66	732-401-WP	22
600-1150-00	54	680-2000-00	11	732-401-WP	47
600-1160-00	54	680-2000-00	40	732-700-00	28
600-1170-00	54	680-2000-W0	11	732-700-00	53
600-1180-00	54	680-2000-W0	40	732-700-0P	28
600-1190-00	54	680-4000-00	11	732-700-0P	53
600-1210-00	54	680-4000-00	40	732-700-W0	28
600-1220-00	54	680-4000-W0	11	732-700-W0	53
600-1240-00	54	680-4000-W0	40	732-700-WP	28
600-1250-00	54	680-6000-00	11	732-700-WP	53
600-1260-00	54	680-6000-00	40	742-401-00	22
600-1270-00	54	680-6000-W0	11	742-401-00	47
600-2000-00	11	680-6000-W0	40	742-401-0P	22
600-2000-00	40	690-2000-00	10	742-401-0P	47
600-2000-W0	11	690-2000-00	39	742-401-W0	22
600-2000-W0	40	690-2000-W0	10	742-401-W0	47
600-3110-00	54	690-2000-W0	39	742-401-WP	22
600-3120-00	54	690-4000-00	10	742-401-WP	47
600-3140-00	54	690-4000-00	39	742-700-00	28
600-3150-00	54	690-4000-W0	10	742-700-00	53
600-3160-00	54	690-4000-W0	39	742-700-0P	28
600-3170-00	54	690-6000-00	10	742-700-0P	53
600-3180-00	54	690-6000-00	39	742-700-W0	28
600-3190-00	54	690-6000-W0	10	742-700-W0	53
600-3210-00	54	690-6000-W0	39	742-700-WP	28
600-3220-00	54	712-401-00	22	742-700-WP	53
600-3240-00	54	712-401-00	47	752-401-00	22
600-3250-00	54	712-401-0P	22	752-401-00	47
600-3260-00	54	712-401-0P	47	752-401-0P	22
600-3270-00	54	712-401-W0	22	752-401-0P	47
600-4000-00	11	712-401-W0	47	752-401-W0	22
600-4000-00	40	712-401-WP	22	752-401-W0	47
600-4000-W0	11	712-401-WP	47	752-401-WP	22
600-4000-W0	40	712-700-00	28	752-401-WP	47
600-5110-00	54	712-700-00	53	752-700-00	28
600-5120-00	54	712-700-0P	28	752-700-00	53
600-5140-00	54	712-700-0P	53	752-700-0P	28
600-5150-00	54	712-700-W0	28	752-700-0P	53
600-5160-00	54	712-700-W0	53	752-700-W0	28
600-5170-00	54	712-700-WP	28	752-700-W0	53



# Index from Typ-Nr.

Typ-Nr.	Page	Typ-Nr.	Page	Typ-Nr.	Page
752-700-WP	28	781-700-WO	48	811-401-00	20
752-700-WP	53	781-700-WP	23	811-401-00	37
761-401-00	17	781-700-WP	48	811-401-00	45
761-401-00	42	782-401-00	17	811-401-0P	20
761-401-0P	17	782-401-00	42	811-401-0P	37
761-401-0P	42	782-401-0P	17	811-401-0P	45
761-401-W0	17	782-401-0P	42	811-401-W0	21
761-401-W0	42	782-401-W0	17	811-401-W0	37
761-401-WP	17	782-401-W0	42	811-401-W0	46
761-401-WP	42	782-401-WP	17	811-401-WP	21
761-700-00	23	782-401-WP	42	811-401-WP	37
761-700-00	48	782-700-00	23	811-401-WP	46
761-700-0P	23	782-700-00	48	811-700-00	26
761-700-0P	48	782-700-0P	23	811-700-00	51
761-700-W0	23	782-700-0P	48	811-700-0P	26
761-700-W0	48	782-700-W0	23	811-700-0P	51
761-700-WP	23	782-700-W0	48	811-700-W0	27
761-700-WP	48	782-700-WP	23	811-700-W0	52
762-401-00	17	782-700-WP	48	811-700-WP	27
762-401-00	42	792-1000-00	29	811-700-WP	52
762-401-0P	17	792-1000-0P	29	812-401-00	20
762-401-0P	42	792-2000-00	29	812-401-00	37
762-401-W0	17	792-2000-0P	29	812-401-00	45
762-401-W0	42	801-000-00	12	812-401-0P	20
762-401-WP	17	801-000-00	16	812-401-0P	37
762-401-WP	42	801-000-00	31	812-401-0P	45
762-700-00	23	801-000-00	41	812-401-W0	21
762-700-00	48	801-000-0P	12	812-401-W0	37
762-700-0P	23	801-000-0P	16	812-401-W0	46
762-700-0P	48	801-000-0P	31	812-401-WP	21
762-700-W0	23	801-000-0P	41	812-401-WP	37
762-700-W0	48	802-000-00	12	812-401-WP	46
762-700-WP	23	802-000-00	16	812-700-00	26
762-700-WP	48	802-000-00	31	812-700-00	51
771-401-00	17	802-000-00	41	812-700-0P	26
771-401-00	42	802-000-0P	12	812-700-0P	51
771-401-0P	17	802-000-0P	16	812-700-W0	27
771-401-0P	42	802-000-0P	31	812-700-W0	52
771-401-W0	17	802-000-0P	41	812-700-WP	27
771-401-W0	42	803-000-00	12	812-700-WP	52
771-401-WP	17	803-000-00	16	813-401-00	20
771-401-WP	42	803-000-00	31	813-401-00	37
772-401-00	17	803-000-00	41	813-401-00	45
772-401-00	42	803-000-0P	12	813-401-0P	20
772-401-0P	17	803-000-0P	16	813-401-0P	37
772-401-0P	42	803-000-0P	31	813-401-0P	45
772-401-W0	17	803-000-0P	41	813-401-W0	21
772-401-W0	42	804-000-00	12	813-401-W0	37
772-401-WP	17	804-000-00	16	813-401-W0	46
772-401-WP	42	804-000-00	31	813-401-WP	21
781-401-00	17	804-000-00	41	813-401-WP	37
781-401-00	42	804-000-0P	12	813-401-WP	46
781-401-0P	17	804-000-0P	16	813-700-00	26
781-401-0P	42	804-000-0P	31	813-700-00	51
781-401-W0	17	804-000-0P	41	813-700-0P	26
781-401-W0	42	805-000-00	12	813-700-0P	51
781-401-WP	17	805-000-00	16	813-700-W0	27
781-401-WP	42	805-000-00	31	813-700-W0	52
781-700-00	23	805-000-00	41	813-700-WP	27
781-700-00	48	805-000-0P	12	813-700-WP	52
781-700-0P	23	805-000-0P	16	814-401-00	20
781-700-0P	48	805-000-0P	31	814-401-00	37
781-700-W0	23	805-000-0P	41	814-401-00	45

# Index from Typ-Nr.

Typ-Nr.	Page	Typ-Nr.	Page	Typ-Nr.	Page
814-.401-0P	20	823-.401-00	45	832-.401-WP	21
814-.401-0P	37	823-.401-0P	20	832-.401-WP	33
814-.401-0P	45	823-.401-0P	37	832-.401-WP	46
814-.401-W0	21	823-.401-0P	45	832-.700-00	26
814-.401-W0	37	823-.401-W0	21	832-.700-00	51
814-.401-W0	46	823-.401-W0	37	832-.700-0P	26
814-.401-WP	21	823-.401-W0	46	832-.700-0P	51
814-.401-WP	37	823-.401-WP	21	832-.700-W0	27
814-.401-WP	46	823-.401-WP	37	832-.700-W0	52
814-.700-00	26	823-.401-WP	46	832-.700-WP	27
814-.700-00	51	824-.401-00	20	832-.700-WP	52
814-.700-0P	26	824-.401-00	37	833-.401-00	20
814-.700-0P	51	824-.401-00	45	833-.401-00	33
814-.700-W0	27	824-.401-0P	20	833-.401-00	45
814-.700-W0	52	824-.401-0P	37	833-.401-0P	20
814-.700-WP	27	824-.401-0P	45	833-.401-0P	33
814-.700-WP	52	824-.401-W0	21	833-.401-0P	45
815-.401-00	20	824-.401-W0	37	833-.401-W0	21
815-.401-00	37	824-.401-W0	46	833-.401-W0	33
815-.401-00	45	824-.401-WP	21	833-.401-W0	46
815-.401-0P	20	824-.401-WP	37	833-.401-WP	21
815-.401-0P	37	824-.401-WP	46	833-.401-WP	33
815-.401-0P	45	825-.401-00	20	833-.401-WP	46
815-.401-W0	21	825-.401-00	37	833-.700-00	26
815-.401-W0	37	825-.401-00	45	833-.700-00	51
815-.401-W0	46	825-.401-0P	20	833-.700-0P	26
815-.401-WP	21	825-.401-0P	37	833-.700-0P	51
815-.401-WP	37	825-.401-0P	45	833-.700-W0	27
815-.401-WP	46	825-.401-W0	21	833-.700-W0	52
815-.700-00	26	825-.401-W0	37	833-.700-WP	27
815-.700-00	51	825-.401-W0	46	833-.700-WP	52
815-.700-0P	26	825-.401-WP	21	834-.401-00	20
815-.700-0P	51	825-.401-WP	37	834-.401-00	33
815-.700-W0	27	825-.401-WP	46	834-.401-00	45
815-.700-W0	52	831-.401-00	20	834-.401-0P	20
815-.700-WP	27	831-.401-00	33	834-.401-0P	33
815-.700-WP	52	831-.401-00	45	834-.401-0P	45
821-.401-00	20	831-.401-0P	20	834-.401-W0	21
821-.401-00	37	831-.401-0P	33	834-.401-W0	33
821-.401-00	45	831-.401-0P	45	834-.401-W0	46
821-.401-0P	20	831-.401-0P	21	834-.401-WP	21
821-.401-0P	37	831-.401-W0	33	834-.401-WP	33
821-.401-0P	45	831-.401-W0	46	834-.401-WP	46
821-.401-W0	21	831-.401-W0	21	834-.700-00	26
821-.401-W0	37	831-.401-WP	33	834-.700-00	51
821-.401-W0	46	831-.401-WP	46	834-.700-0P	26
821-.401-WP	21	831-.700-00	26	834-.700-0P	51
821-.401-WP	37	831-.700-00	51	834-.700-W0	27
821-.401-WP	46	831-.700-0P	26	834-.700-W0	52
822-.401-00	20	831-.700-0P	51	834-.700-WP	27
822-.401-00	37	831-.700-W0	27	834-.700-WP	52
822-.401-00	45	831-.700-W0	52	835-.401-00	20
822-.401-0P	20	831-.700-WP	27	835-.401-00	33
822-.401-0P	37	831-.700-WP	52	835-.401-00	45
822-.401-0P	45	832-.401-00	20	835-.401-0P	20
822-.401-W0	21	832-.401-00	33	835-.401-0P	33
822-.401-W0	37	832-.401-00	45	835-.401-0P	45
822-.401-W0	46	832-.401-0P	20	835-.401-W0	21
822-.401-WP	21	832-.401-0P	33	835-.401-W0	33
822-.401-WP	37	832-.401-0P	45	835-.401-W0	46
822-.401-WP	46	832-.401-W0	21	835-.401-WP	21
823-.401-00	20	832-.401-W0	33	835-.401-WP	33
823-.401-00	37	832-.401-W0	46	835-.401-WP	46

# Index from Typ-Nr.

Typ-Nr.	Page	Typ-Nr.	Page	Typ-Nr.	Page
835-.700-00	26	901-.000-00	41	912-.401-W0	19
835-.700-00	51	901-.000-0P	12	912-.401-W0	35
835-.700-0P	26	901-.000-0P	16	912-.401-W0	44
835-.700-0P	51	901-.000-0P	31	912-.401-WP	19
835-.700-W0	27	901-.000-0P	41	912-.401-WP	35
835-.700-W0	52	902-.000-00	12	912-.401-WP	44
835-.700-WP	27	902-.000-00	16	912-.700-00	24
835-.700-WP	52	902-.000-00	31	912-.700-00	49
840-.000-00	32	902-.000-00	41	912-.700-0P	24
840-.000-0P	32	902-.000-0P	12	912-.700-0P	49
841-.000-00	32	902-.000-0P	16	912-.700-W0	25
841-.000-0P	32	902-.000-0P	31	912-.700-W0	50
842-.000-00	32	902-.000-0P	41	912-.700-WP	25
842-.000-0P	32	903-.000-00	12	912-.700-WP	50
843-.000-00	32	903-.000-00	16	913-.401-00	18
843-.000-0P	32	903-.000-00	31	913-.401-00	35
844-.000-00	32	903-.000-00	41	913-.401-00	43
844-.000-0P	32	903-.000-0P	12	913-.401-0P	18
845-.000-00	32	903-.000-0P	16	913-.401-0P	35
845-.000-0P	32	903-.000-0P	31	913-.401-0P	43
851+2000-00	14	903-.000-0P	41	913-.401-W0	19
851+2000-0P	14	904-.000-00	12	913-.401-W0	35
851+2000-W0	14	904-.000-00	16	913-.401-W0	44
851+2000-WP	14	904-.000-00	31	913-.401-WP	19
852+2000-00	14	904-.000-00	41	913-.401-WP	35
852+2000-0P	14	904-.000-0P	12	913-.401-WP	44
852+2000-W0	14	904-.000-0P	16	913-.700-00	24
852+2000-WP	14	904-.000-0P	31	913-.700-00	49
853+2000-00	14	904-.000-0P	41	913-.700-0P	24
853+2000-0P	14	905-.000-00	12	913-.700-0P	49
853+2000-W0	14	905-.000-00	16	913-.700-W0	25
853+2000-WP	14	905-.000-00	31	913-.700-W0	50
861+2401-00	13	905-.000-00	41	913-.700-WP	25
861+2401-0P	13	905-.000-0P	12	913-.700-WP	50
861+2401-W0	13	905-.000-0P	16	914-.401-00	18
861+2401-WP	13	905-.000-0P	31	914-.401-00	35
862+2401-00	13	905-.000-0P	41	914-.401-00	43
862+2401-0P	13	911-.401-00	18	914-.401-0P	18
862+2401-W0	13	911-.401-00	35	914-.401-0P	35
862+2401-WP	13	911-.401-00	43	914-.401-0P	43
863+2401-00	13	911-.401-0P	18	914-.401-W0	19
863+2401-0P	13	911-.401-0P	35	914-.401-W0	35
863+2401-W0	13	911-.401-0P	43	914-.401-W0	44
863+2401-WP	13	911-.401-W0	19	914-.401-W0	44
881-.000-00	30	911-.401-W0	35	914-.401-WP	19
881-.000-0P	30	911-.401-W0	44	914-.401-WP	35
882-.000-00	30	911-.401-WP	19	914-.401-WP	44
882-.000-0P	30	911-.401-WP	35	914-.700-00	24
883-.000-00	30	911-.401-WP	44	914-.700-00	49
883-.000-0P	30	911-.700-00	24	914-.700-0P	24
884-.000-00	30	911-.700-00	49	914-.700-0P	49
884-.000-0P	30	911-.700-0P	24	914-.700-W0	25
885-.000-00	30	911-.700-0P	49	914-.700-W0	50
885-.000-0P	30	911-.700-W0	25	914-.700-WP	25
890-.000-00	10	911-.700-W0	50	914-.700-WP	50
890-.000-00	39	911-.700-WP	25	915-.401-00	18
890-.000-0P	10	911-.700-WP	50	915-.401-00	35
890-.000-0P	39	912-.401-00	18	915-.401-00	43
890-.000-K0	10	912-.401-00	35	915-.401-0P	18
890-.000-K0	39	912-.401-00	43	915-.401-0P	35
901-.000-00	12	912-.401-0P	18	915-.401-0P	43
901-.000-00	16	912-.401-0P	35	915-.401-W0	19
901-.000-00	31	912-.401-0P	43	915-.401-W0	35
				915-.401-W0	44

# Index from Typ-Nr.

Typ-Nr.	Page	Typ-Nr.	Page	Typ-Nr.	Page
915-.401-WP	19	925-.401-0P	35	933-.700-0P	49
915-.401-WP	35	925-.401-0P	43	933-.700-W0	25
915-.401-WP	44	925-.401-W0	19	933-.700-W0	50
915-.700-00	24	925-.401-W0	35	933-.700-WP	25
915-.700-00	49	925-.401-W0	44	933-.700-WP	50
915-.700-0P	24	925-.401-WP	19	934-.401-00	18
915-.700-0P	49	925-.401-WP	35	934-.401-00	33
915-.700-W0	25	925-.401-WP	44	934-.401-00	43
915-.700-W0	50	931-.401-00	18	934-.401-0P	18
915-.700-WP	25	931-.401-00	33	934-.401-0P	33
915-.700-WP	50	931-.401-00	43	934-.401-0P	43
921-.401-00	18	931-.401-0P	18	934-.401-W0	19
921-.401-00	35	931-.401-0P	33	934-.401-W0	33
921-.401-00	43	931-.401-0P	43	934-.401-W0	44
921-.401-0P	18	931-.401-W0	19	934-.401-WP	19
921-.401-0P	35	931-.401-W0	33	934-.401-WP	33
921-.401-0P	43	931-.401-W0	44	934-.401-WP	44
921-.401-W0	19	931-.401-WP	19	934-.700-00	24
921-.401-W0	35	931-.401-WP	33	934-.700-00	49
921-.401-W0	44	931-.401-WP	44	934-.700-0P	24
921-.401-WP	19	931-.700-00	24	934-.700-0P	49
921-.401-WP	35	931-.700-00	49	934-.700-W0	25
921-.401-WP	44	931-.700-0P	24	934-.700-W0	50
922-.401-00	18	931-.700-0P	49	934-.700-WP	25
922-.401-00	35	931-.700-W0	25	934-.700-WP	50
922-.401-00	43	931-.700-W0	50	935-.401-00	18
922-.401-0P	18	931-.700-WP	25	935-.401-00	33
922-.401-0P	35	931-.700-WP	50	935-.401-0P	43
922-.401-0P	43	932-.401-00	18	935-.401-0P	18
922-.401-W0	19	932-.401-00	33	935-.401-0P	33
922-.401-W0	35	932-.401-00	43	935-.401-0P	43
922-.401-W0	44	932-.401-0P	18	935-.401-W0	19
922-.401-WP	19	932-.401-0P	33	935-.401-W0	33
922-.401-WP	35	932-.401-0P	43	935-.401-W0	44
922-.401-WP	44	932-.401-W0	19	935-.401-WP	19
923-.401-00	18	932-.401-W0	33	935-.401-WP	33
923-.401-00	35	932-.401-W0	44	935-.401-WP	44
923-.401-00	43	932-.401-WP	19	935-.700-00	24
923-.401-0P	18	932-.401-WP	33	935-.700-00	49
923-.401-0P	35	932-.401-WP	44	935-.700-0P	24
923-.401-0P	43	932-.700-00	24	935-.700-0P	49
923-.401-W0	19	932-.700-00	49	935-.700-W0	25
923-.401-W0	35	932-.700-0P	24	935-.700-W0	50
923-.401-W0	44	932-.700-0P	49	935-.700-WP	25
923-.401-WP	19	932-.700-W0	25	935-.700-WP	50
923-.401-WP	35	932-.700-W0	50	940-.000-00	32
923-.401-WP	44	932-.700-WP	25	940-.000-0P	32
924-.401-00	18	932-.700-WP	50	941-.000-00	32
924-.401-00	35	933-.401-00	18	941-.000-0P	32
924-.401-00	43	933-.401-00	33	942-.000-00	32
924-.401-0P	18	933-.401-00	43	942-.000-0P	32
924-.401-0P	35	933-.401-0P	18	943-.000-00	32
924-.401-0P	43	933-.401-0P	33	943-.000-0P	32
924-.401-W0	19	933-.401-0P	43	944-.000-00	32
924-.401-W0	35	933-.401-W0	19	944-.000-0P	32
924-.401-W0	44	933-.401-W0	33	945-.000-00	32
924-.401-W0	44	933-.401-W0	44	945-.000-0P	32
924-.401-WP	19	933-.401-WP	19	951+2000-00	14
924-.401-WP	35	933-.401-WP	33	951+2000-0P	14
924-.401-WP	44	933-.401-WP	44	951+2000-W0	14
925-.401-00	18	933-.700-00	24	951+2000-WP	14
925-.401-00	35	933-.700-00	49	952+2000-00	14
925-.401-00	43	933-.700-0P	24	952+2000-0P	14
925-.401-0P	18				

# Index from Typ-Nr.

Typ-Nr.	Page	Typ-Nr.	Page	Typ-Nr.	Page
952+2000-W0	14				
952+2000-WP	14				
953+2000-00	14				
953+2000-0P	14				
953+2000-W0	14				
953+2000-WP	14				
961+2401-00	13				
961+2401-0P	13				
961+2401-W0	13				
961+2401-WP	13				
962+2401-00	13				
962+2401-0P	13				
962+2401-W0	13				
962+2401-WP	13				
963+2401-00	13				
963+2401-0P	13				
963+2401-W0	13				
963+2401-WP	13				
970-.000-00	11				
970-.000-00	40				
970-.000-0P	11				
970-.000-0P	40				
970-.000-K0	11				
970-.000-K0	40				
970-0006-00	60				
970-0012-00	60				
970-0024-00	60				
970-5006-00	60				
970-5012-00	60				
970-5024-00	60				
970-6006-00	60				
970-6012-00	60				
970-6024-00	60				
970-9006-00	60				
970-9012-00	60				
970-9024-00	60				
981-.000-00	30				
981-.000-0P	30				
982-.000-00	30				
982-.000-0P	30				
983-.000-00	30				
983-.000-0P	30				
984-.000-00	30				
984-.000-0P	30				
985-.000-00	30				
985-.000-0P	30				
990-.000-00	10				
990-.000-00	39				
990-.000-0P	10				
990-.000-0P	39				
990-.000-K0	10				
990-.000-K0	39				

	<b>EAO AG</b>
	Tannwaldstrasse 88 4601 Olten, Switzerland
<b>E-mail</b>	info@eao.com
<b>Website</b>	www.eao.com
	<b>Austria</b>
Phone	+49 201 85 87 0
Fax	+49 201 85 87 210
E-mail	sales.ede@eao.com
	<b>Belgium</b>
Phone	+32 3 777 82 36
Fax	+32 3 777 84 19
E-mail	sales.ebl@eao.com
	<b>China</b>
Phone	+852 27 86 91 41
Fax	+852 27 86 95 61
E-mail	sales.ehk@eao.com
	<b>France</b>
Phone	+33 1 64 43 37 37
Fax	+33 1 64 43 37 49
E-mail	sales.esa@eao.com
	<b>Germany</b>
Phone	+49 201 85 87 0
Fax	+49 201 85 87 210
E-mail	sales.ede@eao.com
	<b>Italy</b>
Phone	+39 035 481 0189
Fax	+39 035 481 3786
E-mail	sales.eit@eao.com
	<b>Japan</b>
Phone	+81 3 5444 5411
Fax	+81 3 5444 0345
E-mail	sales.esj@eao.com
	<b>Netherlands</b>
Phone	+31 78 653 17 00
Fax	+31 78 653 17 99
E-mail	sales.enl@eao.com
	<b>Sweden</b>
Phone	+46 8 683 86 60
Fax	+46 8 724 29 12
E-mail	sales.esw@eao.com
	<b>Switzerland</b>
Phone	+41 62 388 95 00
Fax	+41 62 388 95 55
E-mail	sales.ech@eao.com
	<b>United Kingdom</b>
Phone	+44 1444 236 000
Fax	+44 1444 236 641
E-mail	sales.euk@eao.com
	<b>USA</b>
Phone	+1 203 877 4577
Fax	+1 203 877 3694
E-mail	sales.eus@eao.com
	<b>Other Countries</b>
Phone	+41 62 286 92 10
Fax	+41 62 296 21 62
E-mail	info@eao.com

## Данный компонент на территории Российской Федерации

### Вы можете приобрести в компании MosChip.

Для оперативного оформления запроса Вам необходимо перейти по данной ссылке:

<http://moschip.ru/get-element>

Вы можете разместить у нас заказ для любого Вашего проекта, будь то серийное производство или разработка единичного прибора.

В нашем ассортименте представлены ведущие мировые производители активных и пассивных электронных компонентов.

Нашей специализацией является поставка электронной компонентной базы двойного назначения, продукции таких производителей как XILINX, Intel (ex.ALTERA), Vicor, Microchip, Texas Instruments, Analog Devices, Mini-Circuits, Amphenol, Glenair.

Сотрудничество с глобальными дистрибьюторами электронных компонентов, предоставляет возможность заказывать и получать с международных складов практически любой перечень компонентов в оптимальные для Вас сроки.

На всех этапах разработки и производства наши партнеры могут получить квалифицированную поддержку опытных инженеров.

Система менеджмента качества компании отвечает требованиям в соответствии с ГОСТ Р ИСО 9001, ГОСТ РВ 0015-002 и ЭС РД 009

### Офис по работе с юридическими лицами:

105318, г.Москва, ул.Щербаковская д.3, офис 1107, 1118, ДЦ «Щербаковский»

Телефон: +7 495 668-12-70 (многоканальный)

Факс: +7 495 668-12-70 (доб.304)

E-mail: [info@moschip.ru](mailto:info@moschip.ru)

Skype отдела продаж:

moschip.ru

moschip.ru\_4

moschip.ru\_6

moschip.ru\_9