

High Efficacy
Dental Blue LED Emitter
LZ4-00DB00

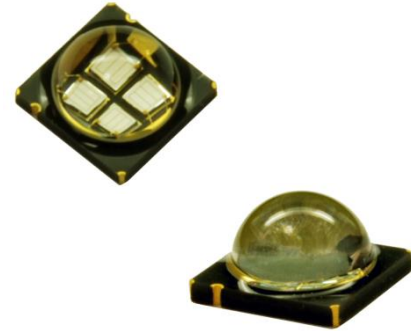

Key Features

- High Efficacy 10W Dental Blue LED
- Ultra-small foot print – 7.0mm x 7.0mm
- Surface mount ceramic package with integrated glass lens
- Very low Thermal Resistance (1.1°C/W)
- Individually addressable die
- Very high Radiant Flux density
- JEDEC Level 1 for Moisture Sensitivity Level
- Autoclave complaint (JEDEC JESD22-A102-C)
- Lead (Pb) free and RoHS compliant
- Reflow solderable (up to 6 cycles)
- Emitter available on Standard MCPCB (optional)

Typical Applications

- Dental Curing
- Teeth Whitening

Description

The LZ4-00DB00 Dental Blue LED emitter provides superior radiometric power in the wavelength range specifically required for dental curing light applications. With a 7.0mm x 7.0mm ultra-small footprint, this package provides exceptional optical power density making it ideal for use in dental curing devices. The radiometric power performance and optimal peak wavelength of this LED are matched to the response curves of many dental resins, resulting in a significantly reduced curing time. LED Engin's LZ4-00DB00 offers ultimate design flexibility with individually addressable die. The patent-pending design has unparalleled thermal and optical performance. The high quality materials used in the package are chosen to optimize light output, have excellent UV resistance, and minimize stresses which results in monumental reliability and radiant flux maintenance.

Part number options

Base part number

Part number	Description
LZ4-00DB00-xxxx	LZ4 emitter
LZ4-40DB00-xxxx	LZ4 emitter on Standard Star 1 channel MCPCB

Bin kit option codes

DB, Dental-Blue (460nm)			
Kit number suffix	Min flux Bin	Color Bin Range	Description
0000	Q	D1 – D1	full distribution flux; full distribution wavelength
R000	R	D1 – D1	R minimum flux bin; full distribution wavelength

Notes:

1. Default bin kit option is -0000

Radiant Flux Bins

Table 1:

Bin Code	Minimum Radiant Flux (Φ) @ $I_F = 700\text{mA}$ ^[1,2] (W)	Maximum Radiant Flux (Φ) @ $I_F = 700\text{mA}$ ^[1,2] (W)
Q	2.0	2.4
R	2.4	3.0
S	3.0	3.8

Notes for Table 1:

1. Radiant flux performance guaranteed within published operating conditions. LED Engin maintains a tolerance of $\pm 10\%$ on flux measurements.
2. Future products will have even higher levels of radiant flux performance. Contact LED Engin Sales for updated information.

Peak Wavelength Bin

Table 2:

Bin Code	Minimum Peak Wavelength (λ_p) @ $I_F = 700\text{mA}$ ^[1] (nm)	Maximum Peak Wavelength (λ_p) @ $I_F = 700\text{mA}$ ^[1] (nm)
D1	457	463

Notes for Table 2:

1. LED Engin maintains a tolerance of $\pm 2.0\text{nm}$ on peak wavelength measurements.

Forward Voltage Bin

Table 3:

Bin Code	Minimum Forward Voltage (V_F) @ $I_F = 700\text{mA}$ ^[1,2] (V)	Maximum Forward Voltage (V_F) @ $I_F = 700\text{mA}$ ^[1,2] (V)
0	12.80	16.64

Notes for Table 3:

1. LED Engin maintains a tolerance of $\pm 0.04\text{V}$ for forward voltage measurements.
2. Forward Voltage is binned with all four LED dice connected in series.

Absolute Maximum Ratings

Table 4:

Parameter	Symbol	Value	Unit
DC Forward Current at $T_{jmax}=135^{\circ}\text{C}^{[1]}$	I_F	1200	mA
DC Forward Current at $T_{jmax}=150^{\circ}\text{C}^{[1]}$	I_F	1000	mA
Peak Pulsed Forward Current ^[2]	I_{FP}	1500	mA
Reverse Voltage	V_R	See Note 3	V
Storage Temperature	T_{stg}	-40 ~ +150	$^{\circ}\text{C}$
Junction Temperature	T_J	150	$^{\circ}\text{C}$
Soldering Temperature ^[4]	T_{sol}	260	$^{\circ}\text{C}$
Allowable Reflow Cycles		6	
Autoclave Conditions ^[5]		121 $^{\circ}\text{C}$ at 2 ATM, 100% RH for 168 hours	
ESD Sensitivity ^[6]		> 8,000 V HBM Class 3B JESD22-A114-D	

Notes for Table 4:

- Maximum DC forward current is determined by the overall thermal resistance and ambient temperature. Follow the curves in Figure 10 for current derating.
- Pulse forward current conditions: Pulse Width \leq 10msec and Duty Cycle \leq 10%.
- LEDs are not designed to be reverse biased.
- Solder conditions per JEDEC 020c. See Reflow Soldering Profile Figure 3.
- Autoclave Conditions per JEDEC JESD22-A102-C.
- LED Engin recommends taking reasonable precautions towards possible ESD damages and handling the LZ4-00DB00 in an electrostatic protected area (EPA). An EPA may be adequately protected by ESD controls as outlined in ANSI/ESD S6.1.

Optical Characteristics @ $T_C = 25^{\circ}\text{C}$

Table 5:

Parameter	Symbol	Typical	Unit
Radiant Flux (@ $I_F = 700\text{mA}$)	Φ	3.25	W
Radiant Flux (@ $I_F = 1000\text{mA}$)	Φ	4.2	W
Peak Wavelength ^[1]	λ_p	460	nm
Viewing Angle ^[2]	$2\theta_{1/2}$	100	Degrees
Total Included Angle ^[3]	$\theta_{0.9}$	120	Degrees

Notes for Table 5:

- Observe IEC 60825-1 class 2 rating for eye safety. Do not stare into the beam.
- Viewing Angle is the off axis angle from emitter centerline where the luminous intensity is $1/2$ of the peak value.
- Total Included Angle is the total angle that includes 90% of the total luminous flux.

Electrical Characteristics @ $T_C = 25^{\circ}\text{C}$

Table 6:

Parameter	Symbol	Typical		Unit
		1 Die	4 Dice	
Forward Voltage (@ $I_F = 700\text{mA}$)	V_F	3.5	14.0	V
Forward Voltage (@ $I_F = 1000\text{mA}$)	V_F	3.7	14.6	V
Temperature Coefficient of Forward Voltage	$\Delta V_F/\Delta T_J$	-10.4		mV/ $^{\circ}\text{C}$
Thermal Resistance (Junction to Case)	RO_{J-C}	1.1		$^{\circ}\text{C}/\text{W}$

IPC/JEDEC Moisture Sensitivity Level

Table 7 - IPC/JEDEC J-STD MSL-20 Classification:

Level	Floor Life		Soak Requirements			
	Time	Conditions	Standard	Accelerated	Time (hrs)	Conditions
1	Unlimited	≤ 30°C/ 85% RH	168 +5/-0	85°C/ 85% RH	n/a	n/a

Notes for Table 7:

- The standard soak time is the sum of the default value of 24 hours for the semiconductor manufacturer's exposure time (MET) between bake and bag and the floor life of maximum time allowed out of the bag at the end user of distributor's facility.

Average Radiant Flux Maintenance Projections

Based on long-term WHTOL testing, LED Engin projects that the LZ Series will deliver, on average, 70% Radiant Flux Maintenance at 65,000 hours of operation at a forward current of 700 mA. This projection is based on constant current operation with junction temperature maintained at or below 125°C.

Mechanical Dimensions (mm)



Figure 1: Package outline drawing.

Notes for Figure 1:

1. Unless otherwise noted, the tolerance = ± 0.20 mm.
2. Thermal contact, Pad 9, is electrically neutral.

Recommended Solder Pad Layout (mm)

Non-pedestal MCPCB Design



Pedestal MCPCB Design

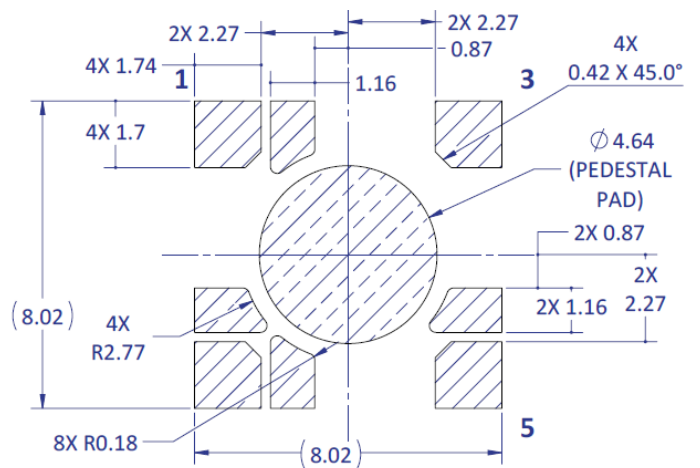

Figure 2a: Recommended solder pad layout for anode, cathode, and thermal pad for non-pedestal and pedestal design

Note for Figure 2a:

1. Unless otherwise noted, the tolerance = ± 0.20 mm.
2. Pedestal MCPCB allows the emitter thermal slug to be soldered directly to the metal core of the MCPCB. Such MCPCB eliminate the high thermal resistance dielectric layer that standard MCPCB technologies use in between the emitter thermal slug and the metal core of the MCPCB, thus lowering the overall system thermal resistance.
3. LED Engin recommends x-ray sample monitoring for solder voids underneath the emitter thermal slug. The total area covered by solder voids should be less than 20% of the total emitter thermal slug area. Excessive solder voids will increase the emitter to MCPCB thermal resistance and may lead to higher failure rates due to thermal over stress.

Recommended Solder Mask Layout (mm)



Figure 2b: Recommended solder mask opening for anode, cathode, and thermal pad for non-pedestal and pedestal design

Note for Figure 2b:

1. Unless otherwise noted, the tolerance = ± 0.20 mm.

Recommended 8 mil Stencil Apertures Layout (mm)



Figure 2c: Recommended 8mil stencil apertures for anode, cathode, and thermal pad for non-pedestal and pedestal design

Note for Figure 2c:

1. Unless otherwise noted, the tolerance = ± 0.20 mm.

Reflow Soldering Profile



Figure 3: Reflow soldering profile for lead free soldering.

Typical Radiation Pattern

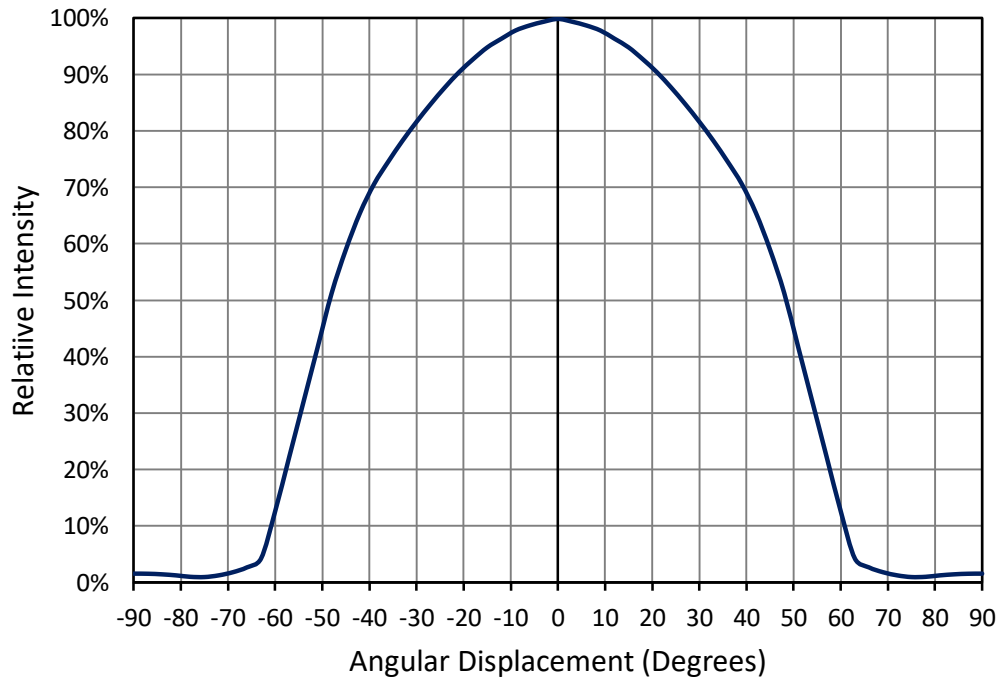

Figure 4: Typical representative spatial radiation pattern.

Typical Relative Spectral Power Distribution

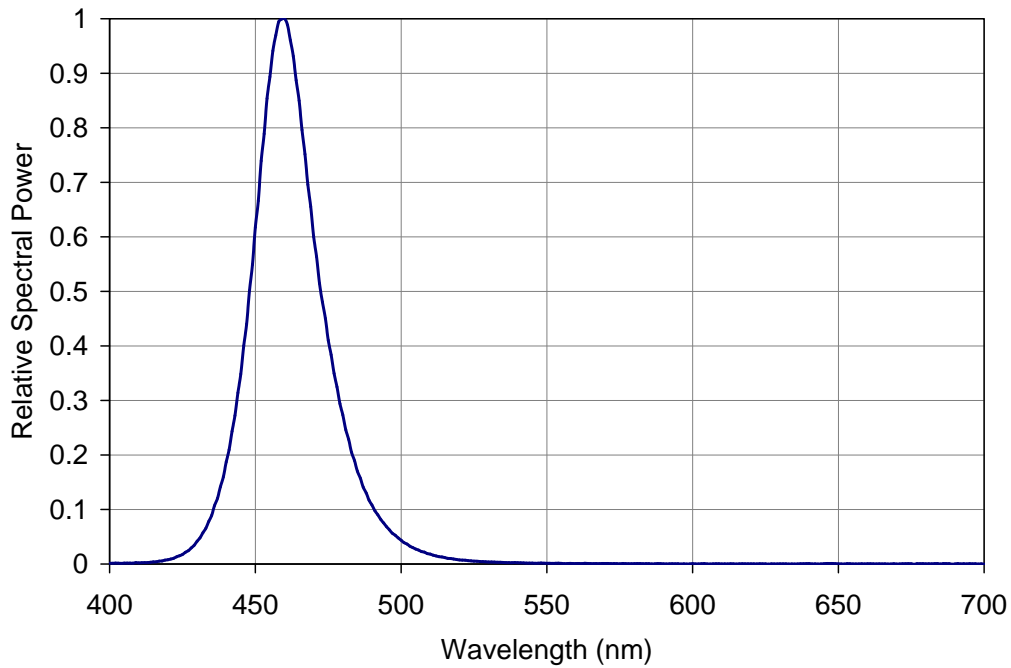

Figure 5: Typical relative spectral power vs. wavelength @ $T_c = 25^\circ\text{C}$.

Typical Peak Wavelength Shift over Temperature

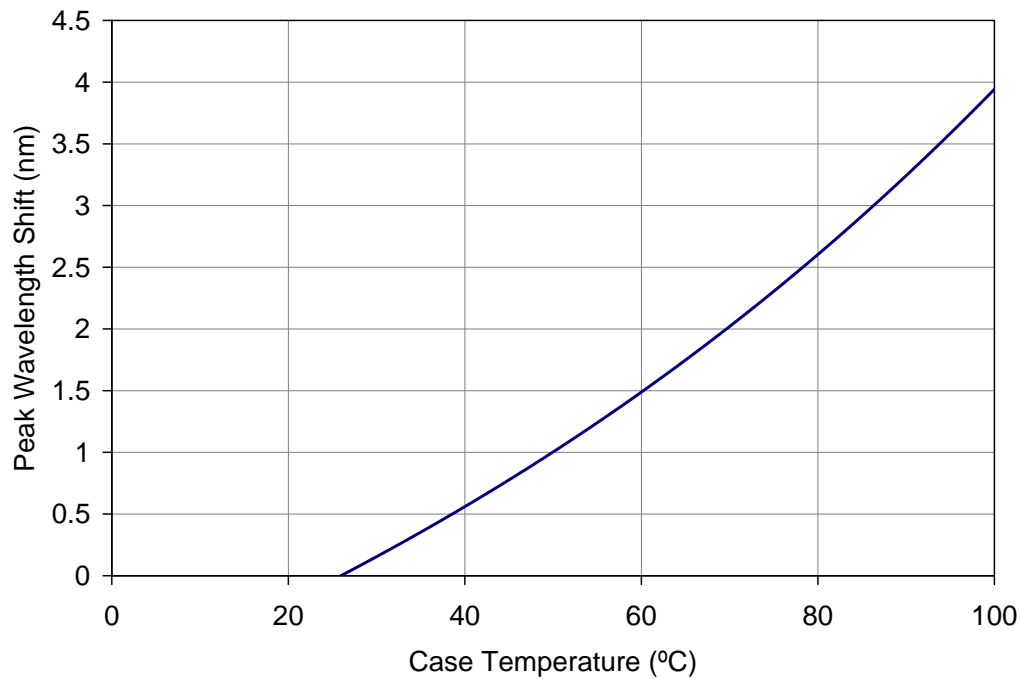

Figure 6: Typical peak wavelength shift vs. case temperature.

Typical Normalized Radiant Flux

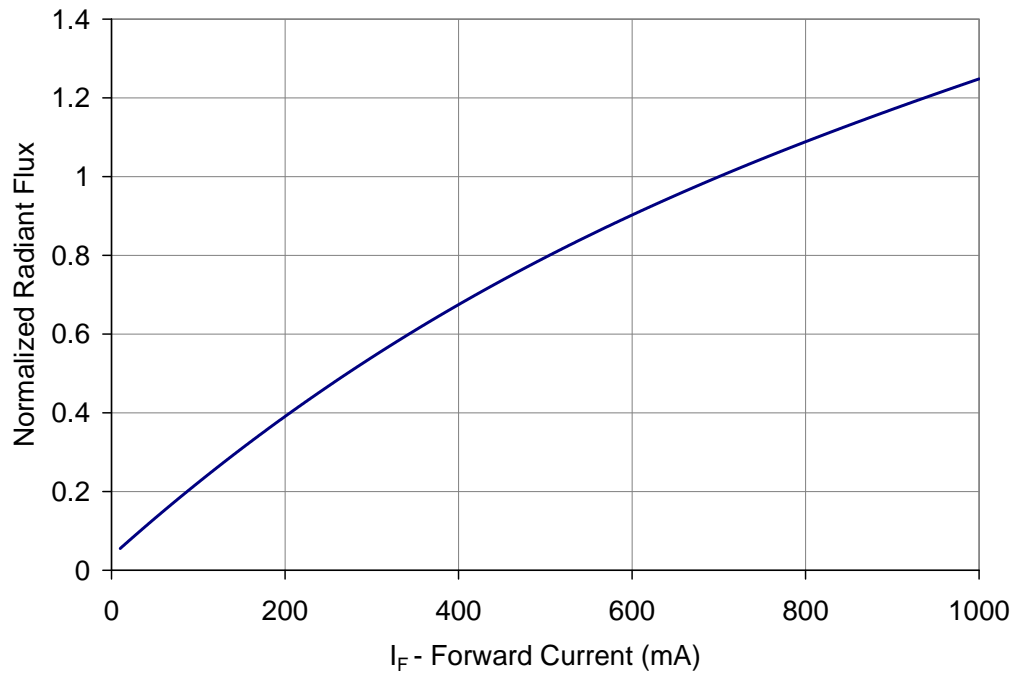

Figure 7: Typical normalized radiant flux vs. forward current @ $T_C = 25^\circ\text{C}$.

Typical Normalized Radiant Flux over Temperature



Figure 8: Typical normalized radiant flux vs. case temperature.

Typical Forward Current Characteristics



Figure 9: Typical forward current vs. forward voltage @ $T_C = 25^\circ\text{C}$.

Current De-rating



Figure 10: Maximum forward current vs. ambient temperature based on $T_{J(\text{MAX})} = 150^\circ\text{C}$.

Notes for Figure 10:

1. RO_{J-C} [Junction to Case Thermal Resistance] for the LZ4-00DB00 is typically 1.1°C/W .
2. RO_{J-A} [Junction to Ambient Thermal Resistance] = $RO_{J-C} + RO_{C-A}$ [Case to Ambient Thermal Resistance].

Emitter Tape and Reel Specifications (mm)

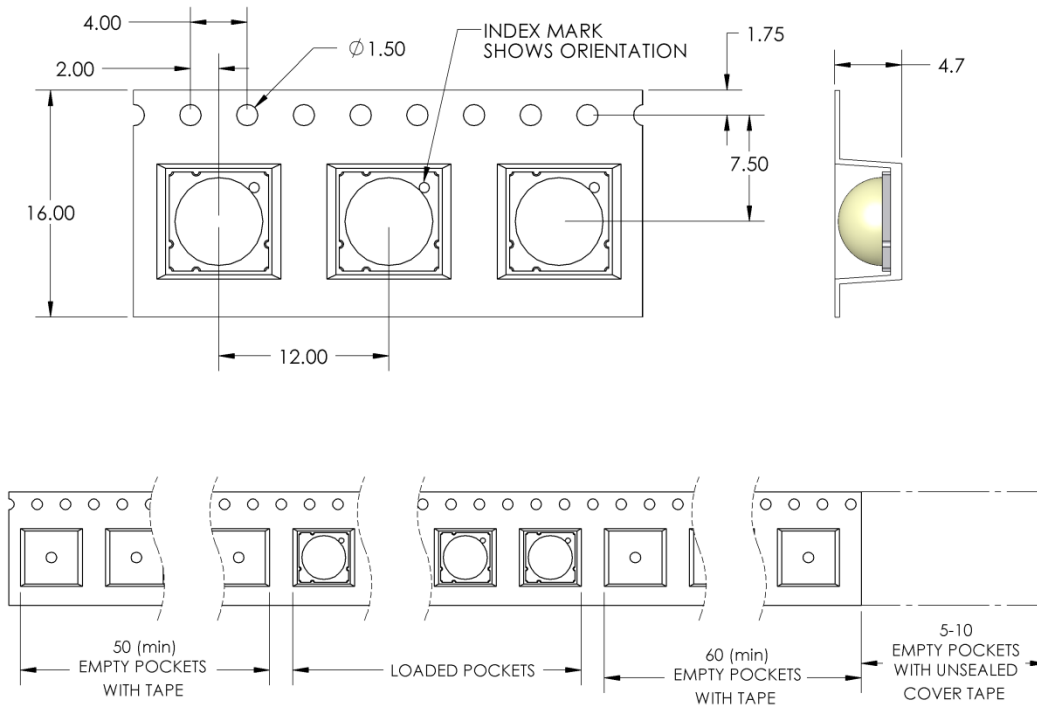

Figure 11: Emitter carrier tape specifications (mm).



Figure 12: Emitter Reel specifications (mm).

LZ4 MCPCB Family

Part number	Type of MCPCB	Diameter (mm)	Emitter + MCPCB Thermal Resistance (°C/W)	Typical V _f (V)	Typical I _f (mA)
LZ4-4xxxxxx	1-channel	19.9	1.1 + 1.1 = 2.2	14.0	700

Mechanical Mounting of MCPCB

- MCPCB bending should be avoided as it will cause mechanical stress on the emitter, which could lead to substrate cracking and subsequently LED dies cracking.
- To avoid MCPCB bending:
 - Special attention needs to be paid to the flatness of the heat sink surface and the torque on the screws.
 - Care must be taken when securing the board to the heat sink. This can be done by tightening three M3 screws (or #4-40) in steps and not all the way through at once. Using fewer than three screws will increase the likelihood of board bending.
 - It is recommended to always use plastics washers in combinations with the three screws.
 - If non-taped holes are used with self-tapping screws, it is advised to back out the screws slightly after tightening (with controlled torque) and then re-tighten the screws again.

Thermal interface material

- To properly transfer heat from LED emitter to heat sink, a thermally conductive material is required when mounting the MCPCB on to the heat sink.
- There are several varieties of such material: thermal paste, thermal pads, phase change materials and thermal epoxies. An example of such material is Electrolube EHTC.
- It is critical to verify the material's thermal resistance to be sufficient for the selected emitter and its operating conditions.

Wire soldering

- To ease soldering wire to MCPCB process, it is advised to preheat the MCPCB on a hot plate of 125-150°C. Subsequently, apply the solder and additional heat from the solder iron will initiate a good solder reflow. It is recommended to use a solder iron of more than 60W.
- It is advised to use lead-free, no-clean solder. For example: SN-96.5 AG-3.0 CU 0.5 #58/275 from Kester (pn: 24-7068-7601)

LZ4-4xxxxx

1 channel, Standard Star MCPCB (1x4) Dimensions (mm)



Notes:

- Unless otherwise noted, the tolerance = ± 0.2 mm.
- Slots in MCPCB are for M3 or #4-40 mounting screws.
- LED Engin recommends plastic washers to electrically insulate screws from solder pads and electrical traces.
- Electrical connection pads on MCPCB are labeled "+" for Anode and "-" for Cathode
- LED Engin recommends thermal interface material when attaching the MCPCB to a heatsink
- The thermal resistance of the MCPCB is: R θ C-B 1.1°C/W

Components used

MCPCB: HT04503 (Bergquist)
ESD chips: BZX585-C30 (NXP, for 4 LED dies in series)

Pad layout			
Ch.	MCPCB Pad	String/die	Function
1	1, 2, 3	1/ABCD	Cathode -
	4, 5		Anode +

About LED Engin

LED Engin, an OSRAM business based in California's Silicon Valley, develops, manufactures, and sells advanced LED emitters, optics and light engines to create uncompromised lighting experiences for a wide range of entertainment, architectural, general lighting and specialty applications. LuxiGen™ multi-die emitter and secondary lens combinations reliably deliver industry-leading flux density, upwards of 5000 quality lumens to a target, in a wide spectrum of colors including whites, tunable whites, multi-color and UV LEDs in a unique patented compact ceramic package. Our LuxiTune™ series of tunable white lighting modules leverage our LuxiGen emitters and lenses to deliver quality, control, freedom and high density tunable white light solutions for a broad range of new recessed and downlighting applications. The small size, yet remarkably powerful beam output and superior in-source color mixing, allows for a previously unobtainable freedom of design wherever high-flux density, directional light is required. LED Engin is committed to providing products that conserve natural resources and reduce greenhouse emissions; and reserves the right to make changes to improve performance without notice.

For more information, please contact LEDE-Sales@osram.com or +1 408 922-7200.

Данный компонент на территории Российской Федерации

Вы можете приобрести в компании MosChip.

Для оперативного оформления запроса Вам необходимо перейти по данной ссылке:

<http://moschip.ru/get-element>

Вы можете разместить у нас заказ для любого Вашего проекта, будь то серийное производство или разработка единичного прибора.

В нашем ассортименте представлены ведущие мировые производители активных и пассивных электронных компонентов.

Нашей специализацией является поставка электронной компонентной базы двойного назначения, продукции таких производителей как XILINX, Intel (ex.ALTERA), Vicor, Microchip, Texas Instruments, Analog Devices, Mini-Circuits, Amphenol, Glenair.

Сотрудничество с глобальными дистрибьюторами электронных компонентов, предоставляет возможность заказывать и получать с международных складов практически любой перечень компонентов в оптимальные для Вас сроки.

На всех этапах разработки и производства наши партнеры могут получить квалифицированную поддержку опытных инженеров.

Система менеджмента качества компании отвечает требованиям в соответствии с ГОСТ Р ИСО 9001, ГОСТ РВ 0015-002 и ЭС РД 009

Офис по работе с юридическими лицами:

105318, г.Москва, ул.Щербаковская д.3, офис 1107, 1118, ДЦ «Щербаковский»

Телефон: +7 495 668-12-70 (многоканальный)

Факс: +7 495 668-12-70 (доб.304)

E-mail: info@moschip.ru

Skype отдела продаж:

moschip.ru

moschip.ru_4

moschip.ru_6

moschip.ru_9