

PS2P-LIN.

Linear touchless position sensor.



Main features.

- True touchless operation: free from wear and tear.
- Low profile & robust magnetic design that easily adapts to your design.
- Selectable output: analogue (ratiometric) or PWM. SPI upon request.
- Programmable measuring range: up to 12mm.
- Resolution: analogue & PWM: 12 bits / SPI: 14 bits.
- Linearity: +/-1% absolute (+/-0.5% upon request).
- Over voltage protection up to 30V.
- Reverse voltage protection up to -50V.
- Supply voltage up to 30V.
- Programmable linear transfer characteristic (some positive slopes & one negative slope can be programmed in the same transfer characteristic; up to 4 programmable points)
- Unlimited mechanical life.
- High vertical & lateral tolerance to magnet misalignment.
- Simple, redundant and full redundant versions available.
- Sealed for harsh environments.
- Operating temperature: -40°C to +125°C
- Self-diagnostic features.

- Agriculture.
- Construction & forestry.
- Material handling.
- Lifts & cranes.
- Marine.

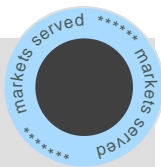

Sensing the position, avoiding contact.

The linear touchless linear sensors create immunity to magnet's misalignment that negatively impacts operational performance and results in labour intensive maintenance programmes. It complements our concentric and variable air-gap touchless series of non-contact angular rotary position sensors.

The magnet is attached to the moving parts whose displacement is to be measured, such as hydraulic/pneumatic controls or gear selector, and the electronics module is fixed to the chassis (or vice versa).

As absolute sensors, they will not lose the values even after a power failure.

All Piher touchless sensors are compact, sealed, low-profile, yet extremely rugged and can be custom-engineered to fit customer's specifications and existing mechanical assemblies.

Description.

Something that is truly contactless. One magnet, One electronics module. No gears. Nothing to wear out over a lifetime.

A sensor that will deliver the same level of precision and stability throughout its life as the first day it was installed -despite extremes of vibration, shock, temperature and contamination.

Something that is easy to assemble -delivering additional cost reduction on the production line.

Something that can be fitted anywhere on the pivoting shaft, giving engineers the flexibility to be creative.

Our touchless sensor is Piher Sensing Systems at its best, packaging its core technology -slimline magnetic Hall Effect sensing- into something truly original.

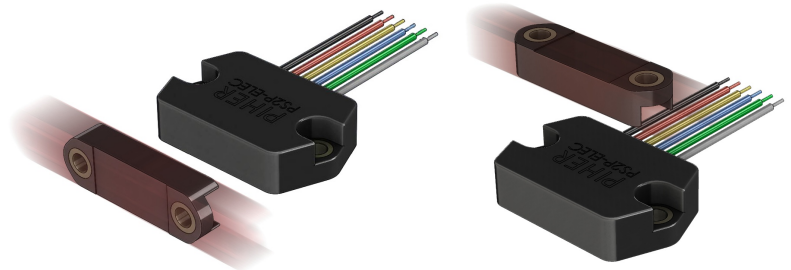

Lateral magnet linear displacement version.

Concentric magnet linear displacement version.

Touchless working principle

Measurement of linear position using variation of magnetic field amplitude induced by the displacement of a moving magnet has been intensively developed over the last fifteen years. However, these solutions have limits in terms of angular range and temperature



influence.

The technology used by Piher is only sensitive to the flux density coplanar with the IC surface.

The absolute position information is computed from both vectorial components of the flux density (i.e. BX and BY) of a magnet. Then an output signal proportional to the decoded position is produced.



PS2P-LIN. Dimensions

Linear touchless position sensor

Dimensions in mm. Drawings not to scale.
Number and function of wires pictured in this datasheet may vary according to the selected output configuration.

PS2P-LIN-CE version. *Concentric magnet linear displacement.*

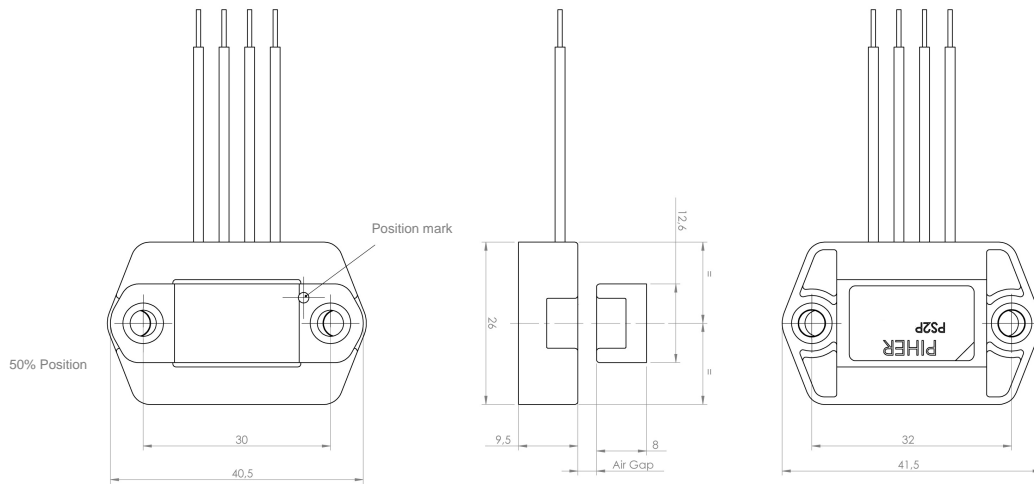

PS2P-LIN-LA version. *Lateral magnet linear displacement.*



PS2P-LIN. Ordering information

Linear touchless position sensor

Part number examples:

Redundant type with lateral magnet, PWM output, L0003 function, linear sensing of 12mm and 5V supply: PS2P-LIN-LA-M002-2PP-L0003-ELS120-05-F200F200

Simple type with magnet on top, analog output, L0000 output function, linear sensing of 12mm and 5V supply : PS2P-LIN-CE-M002-1A0-L0000-ELS120-05

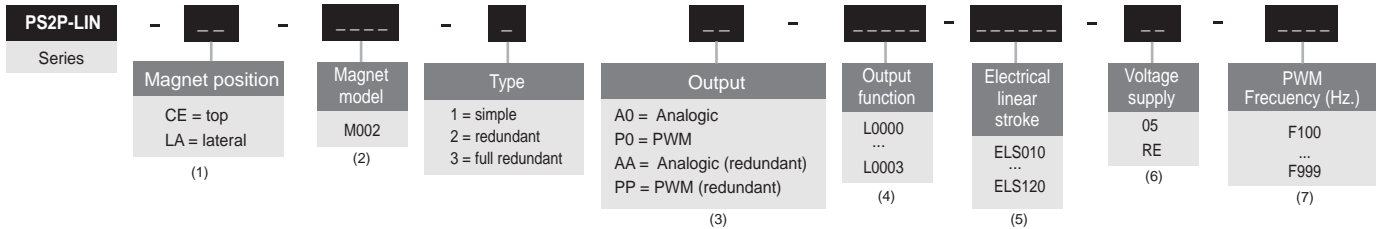

(1) [Free online expert advice at http://piher.net/configurator/2018/04/13/touchless-sensor-configurator/](http://piher.net/configurator/2018/04/13/touchless-sensor-configurator/) Magnet position

Magnet on top.



Lateral magnet.



(2) Magnet Model

M002
Magnet for linear sensing



(3) Output

The analog output is a ratiometric output, proportional to:
 - For supply voltage 5V: to input supply voltage.
 - For supply voltage RE: to 5V.

(4) Output function

Other output functions available check availability. In the How To Order reference, enter LXXXX if the new output function reference has not yet been defined.

Standard output functions:

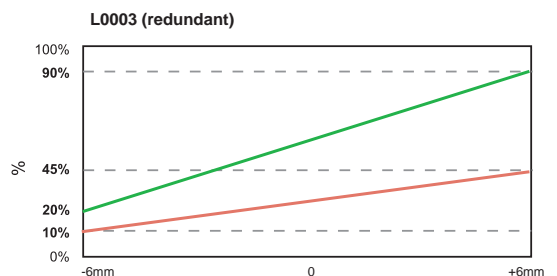
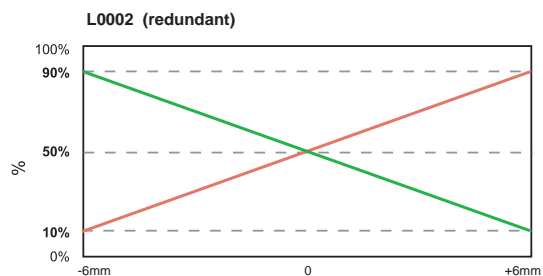
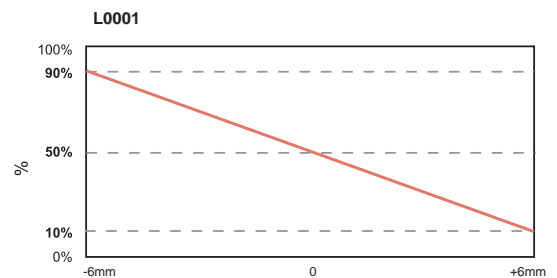
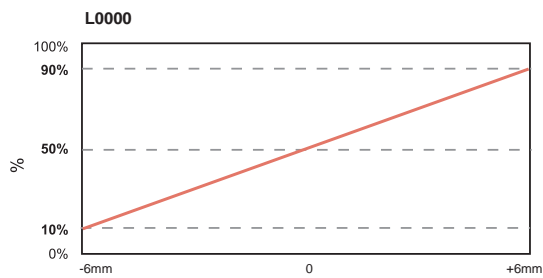

(5) Electrical linear stroke

ELS = measured in steps of 0.1mm. Examples:
 ELS010 = 1mm effective electrical stroke (minimum).
 ELS100 = 10mm effective electrical stroke.
 ELS120 = 12mm of effective electrical stroke.
 For larger strokes: check availability.

(6) Voltage supply

05: 5V ±10%
 RE: 7V - 30V
 RE not available for full redundant versions.

(7) PWM frequency

Leave empty if no applicable. Default frequency is 200 Hz
 For redundant versions, please, write both frequencies: -FXXXXXXX

Disclaimer

The product information in this catalogue is for reference purposes. Please consult for the most up to date and accurate design information.

Piher Sensors & Controls S.A., its affiliates, agents, and employees, and all persons acting on its or their behalf (collectively, "Piher"), disclaim any and all liability for any errors, inaccuracies or incompleteness contained herein or in any other disclosure relating to any product described herein.

Piher disclaims any and all liability arising out of the use or application of any product described herein or of any information provided herein to the maximum extent permitted by law. The product specifications do not expand or otherwise modify Piher's terms and conditions of sale, including but not limited to the warranty expressed therein, which apply to these products.

No licence, express or implied, by estoppel or otherwise, to any intellectual property rights is granted by this document or by any conduct of Piher.

The products shown herein are not designed for use in medical, life-saving, or life-sustaining applications unless otherwise expressly indicated. Customers using or selling Piher products not expressly indicated for use in such applications do so entirely at their own risk and agree to fully indemnify Piher for any damages arising or resulting from such use or sale. Please contact authorised Piher personnel to obtain written terms and conditions regarding products designed for such applications.

Product names and markings noted herein may be trademarks of their respective owners. **Piher is an Amphenol™ company.**

Information contained in and/or attached to this catalogue may be subject to export control regulations of the European Community, USA, or other countries. Each recipient of this document is responsible to ensure that usage and/or transfer of any information contained in this document complies with all relevant export control regulations. If you are in any doubt about the export control restrictions that apply to this information, please contact the sender immediately. For any Piher Exports, Note: All products / technologies are EAR99 Classified commodities. Exports from the United States are in accordance with the Export Administration Regulations. Diversion contrary to US law is prohibited.

All Piher products can be adapted to meet customer's requirements. Consider the environment before printing.
Please always use the latest updated datasheets published at our website www.piher.net.

v060918



Данный компонент на территории Российской Федерации

Вы можете приобрести в компании MosChip.

Для оперативного оформления запроса Вам необходимо перейти по данной ссылке:

<http://moschip.ru/get-element>

Вы можете разместить у нас заказ для любого Вашего проекта, будь то серийное производство или разработка единичного прибора.

В нашем ассортименте представлены ведущие мировые производители активных и пассивных электронных компонентов.

Нашей специализацией является поставка электронной компонентной базы двойного назначения, продукции таких производителей как XILINX, Intel (ex.ALTERA), Vicor, Microchip, Texas Instruments, Analog Devices, Mini-Circuits, Amphenol, Glenair.

Сотрудничество с глобальными дистрибьюторами электронных компонентов, предоставляет возможность заказывать и получать с международных складов практически любой перечень компонентов в оптимальные для Вас сроки.

На всех этапах разработки и производства наши партнеры могут получить квалифицированную поддержку опытных инженеров.

Система менеджмента качества компании отвечает требованиям в соответствии с ГОСТ Р ИСО 9001, ГОСТ РВ 0015-002 и ЭС РД 009

Офис по работе с юридическими лицами:

105318, г.Москва, ул.Щербаковская д.3, офис 1107, 1118, ДЦ «Щербаковский»

Телефон: +7 495 668-12-70 (многоканальный)

Факс: +7 495 668-12-70 (доб.304)

E-mail: info@moschip.ru

Skype отдела продаж:

moschip.ru

moschip.ru_4

moschip.ru_6

moschip.ru_9