

X2PT IGBT Module

advanced

 $V_{CES} = 1200\text{ V}$
 $I_{C25} = 312\text{ A}$
 $V_{CE(sat)} = 1.7\text{ V}$

6-Pack + NTC + Shunt

Part number

MIXG240W1200PZTEH

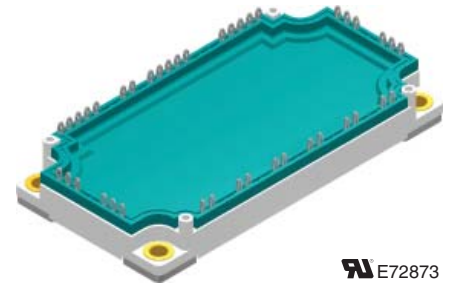

E72873

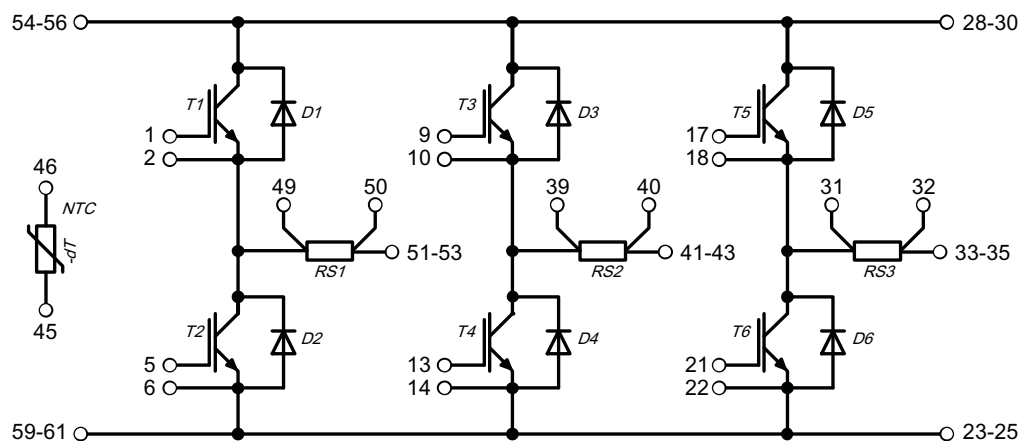
Features / Advantages:

- X2PT - 2nd generation Xtreme light Punch Through
- $T_{vjm} = 175^{\circ}\text{C}$
- Easy paralleling due to the positive temperature coefficient of the on-state voltage
- Rugged X2PT design results in:
 - short circuit rated for 10 $\mu\text{sec.}$
 - very low gate charge
 - low EMI
 - square RBSOA @ 2x I_c
- Low $V_{CE(sat)}$ and low thermal resistance
- SONIC2™ diode
 - fast and soft reverse recovery
 - low operating forward voltage

Applications:

- AC motor drives
- Solar inverter
- Medical equipment
- Uninterruptible power supply
- Air-conditioning systems
- Welding equipment
- Switched-mode and resonant-mode power supplies
- Inductive heating, cookers
- Pumps, Fans

Package: E3-Pack

- Isolation Voltage: 4300 V~
- Industry standard outline
- RoHS compliant
- Base plate: Copper internally DCB isolated
- Advanced power cycling
- PressFit pins

Option:

- Phase Change Material printed on base plate

Terms & Conditions of usage

The data contained in this product data sheet is exclusively intended for technically trained staff. The user will have to evaluate the suitability of the product for the intended application and the completeness of the product data with respect to his application. The specifications of our components may not be considered as an assurance of component characteristics. The information in the valid application- and assembly notes must be considered. Should you require product information in excess of the data given in this product data sheet or which concerns the specific application of your product, please contact your local sales office.

Due to technical requirements our product may contain dangerous substances. For information on the types in question please contact your local sales office.

Should you intend to use the product in aviation, in health or life endangering or life support applications, please notify. For any such application we urgently recommend

- to perform joint risk and quality assessments;

- the conclusion of quality agreements;

- to establish joint measures of an ongoing product survey, and that we may make delivery dependent on the realization of any such measures.

IXYS reserves the right to change limits, test conditions and dimensions.

20180403a

Inverter IGBT T1 - T6				Ratings			
Symbol	Definitions	Conditions	min.	typ.	max.		
V_{CES}	collector emitter voltage	$I_R = 500 \mu A$	$T_{VJ} = 25^\circ C$	1200		V	
V_{GES}	max. DC gate voltage			-20	+20	V	
V_{GEM}	max. transient gate emitter voltage			-30	+30	V	
I_{C25}	collector current		$T_C = 25^\circ C$		312	A	
I_{C80}			$T_C = 80^\circ C$		233	A	
I_{C100}			$T_C = 100^\circ C$		200	A	
P_{tot}	total power dissipation		$T_C = 25^\circ C$		938	W	
$V_{CE(sat)}$	collector emitter saturation voltage on die level	$I_C = 200 A; V_{GE} = 15 V$	$T_{VJ} = 25^\circ C$ $T_{VJ} = 150^\circ C$	1.7 2	2	V V	
$V_{GE(th)}$	gate emitter threshold voltage	$I_C = 8 mA; V_{GE} = V_{GE}$	$T_{VJ} = 25^\circ C$	6.0	7.5	V	
I_{CES}	collector emitter leakage current (includes diode reverse current)	$V_{CE} = V_{CES}; V_{GE} = 0 V$	$T_{VJ} = 25^\circ C$ $T_{VJ} = 150^\circ C$	2.5	0.15	mA mA	
I_{GES}	gate emitter leakage current	$V_{GE} = \pm 20 V$			500	nA	
R_G	internal gate resistance			6.5		Ω	
C_{iss}	input capacitance	$V_{CE} = 100 V; V_{GS} = 0 V; f = 1 MHz$		10.6		nF	
C_{oss}	output capacitance					pF	
C_{rss}	reverse transfer (Miller) capacitance					pF	
Q_g	total gate charge	$V_{CE} = 600 V; V_{GE} = 0 / 15 V; I_C = 200 A$		630		nC	
Q_{gs}	gate source charge					nC	
Q_{gd}	gate drain (Miller) charge					nC	
$t_{d(on)}$	turn-on delay time	Inductive switching $V_{CE} = 680 V; I_C = 200 A$ $V_{GE} = \pm 15 V; R_G = 3.9 \Omega$ (external)	$T_{VJ} = 25^\circ C$		170	ns	
t_r	current rise time					55	ns
$t_{d(off)}$	turn-off delay time					290	ns
t_f	current fall time					120	ns
E_{on}	turn-on energy per pulse					17.1	mJ
E_{off}	turn-off energy per pulse					14.2	mJ
$E_{rec(off)}$	reverse recovery losses at turn-off					3.5	mJ
$t_{d(on)}$	turn-on delay time	Inductive switching $V_{CE} = 680 V; I_C = 200 A$ $V_{GE} = \pm 15 V; R_G = 3.9 \Omega$ (external)	$T_{VJ} = 150^\circ C$		180	ns	
t_r	current rise time					70	ns
$t_{d(off)}$	turn-off delay time					360	ns
t_f	current fall time					215	ns
E_{on}	turn-on energy per pulse					23.5	mJ
E_{off}	turn-off energy per pulse					20.5	mJ
$E_{rec(off)}$	reverse recovery losses at turn-off					9.2	mJ
RBSOA	reverse bias safe operating area	$V_{GE} = \pm 15 V; R_G = 3.9 \Omega$	$T_{VJ} = 150^\circ C$		400	A	
I_{CM}		$V_{CEmax} = 1200 V$					
SCSOA	short circuit safe operating area	$V_{CEmax} = 1200 V$	$T_{VJ} = 150^\circ C$		900	μs A	
t_{SC}	short circuit duration	$V_{CE} = 900 V; V_{GE} = \pm 15 V$					
I_{SC}	short circuit duration	non-repetitive					
R_{thJC}	thermal resistance junction to case	with heatsink compound; IXYS test setup		0.24	0.16	K/W K/W	
R_{thJH}	thermal resistance junction to heatsink						

Inverter Diode D1 - D6				Ratings		
Symbol	Definitions	Conditions	min.	typ.	max.	Unit
V_{RRM}	max. repetitive reverse voltage	$I_R = 500 \mu A$, see V_{CES}	$T_{VJ} = 25^\circ C$	1200		1200 V
I_{F25}	forward current		$T_C = 25^\circ C$			189 A
I_{F80}			$T_C = 80^\circ C$			136 A
I_{F100}			$T_C = 100^\circ C$			114 A
V_F	forward voltage on die level	$I_F = 150 A$	$T_{VJ} = 25^\circ C$ $T_{VJ} = 150^\circ C$		1.7 1.65	2.0 1.95 V
I_R	reverse current * not applicable, see I_{ces} at IGBT	$V_R = V_{RRM}$	$T_{VJ} = 25^\circ C$ $T_{VJ} = 150^\circ C$		*	* mA mA
Q_{RM}	reverse recovery charge	$V_{CE} = 600 V$; $I_C = 150 A$ $V_{GE} = \pm 15 V$; $R_G = 3.9 \Omega$ (external)	$T_{VJ} = 25^\circ C$		11.4	μC
I_{RM}	max. reverse recovery current				150	A
t_{rr}	reverse recovery time				230	ns
E_{rec}	reverse recovery energy				3.5	mJ
Q_{RM}	reverse recovery charge	$V_{CE} = 600 V$; $I_C = 150 A$ $V_{GE} = \pm 15 V$; $R_G = 3.9 \Omega$ (external)	$T_{VJ} = 150^\circ C$		25.3	μC
I_{RM}	max. reverse recovery current				170	A
t_{rr}	reverse recovery time				420	ns
E_{rec}	reverse recovery energy				9.2	mJ
R_{thJC}	thermal resistance junction to case	with heatsink compound; IXYS test setup			0.38	K/W
R_{thJH}	thermal resistance junction to heatsink			0.48	K/W	

Shunt Resistor				Ratings		
Symbol	Definitions	Conditions	min.	typ.	max.	Unit
R_{SHUNT}	resistance tolerance		$T_C = 25^\circ C$		0.5	m Ω
R_{thSH}	thermal resistance shunt to heatsink	with heatsink compound; IXYS test setup *			10	K/W

* Note: Continuous shunt temperature should not exceed 170°C

Temperature Sensor NTC						
Symbol	Definitions	Conditions	min.	typ.	max.	Unit
R_{25}	resistance	$T_{VJ} = 25^\circ C$	4.75	5.0	5.25	k Ω
$B_{25/50}$	temperature coefficient			3375		K

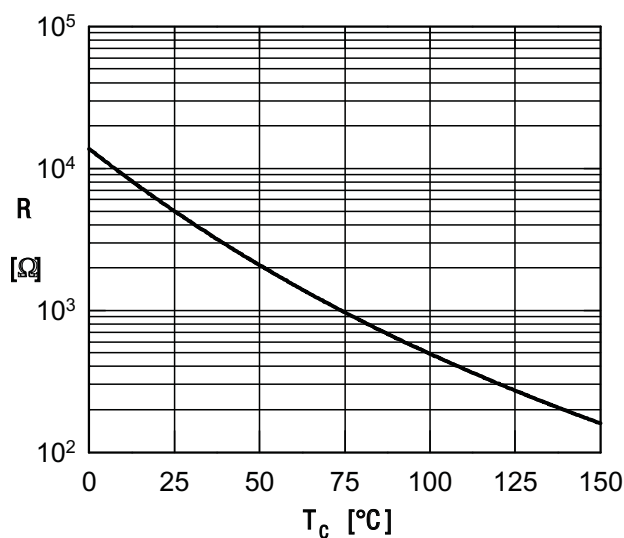

Typ. NTC resistance vs. temperature

advanced

Package E3-Pack				Ratings		
Symbol	Definitions	Conditions	min.	typ.	max.	Unit
I_{RMS}	RMS current	per terminal			30	A
T_{stg}	storage temperature		-40		125	°C
T_{op}	operation temperature		-40		150	°C
T_{VJ}	virtual junction temperature		-40		175	°C
Weight					320	g
M_D	mounting torque		3		6	Nm
d_{Spp}	creepage distance on surface	terminal to terminal	6			mm
d_{Spb}		terminal to backside	12			mm
d_{App}	striking distance through air	terminal to terminal	6			mm
d_{Apb}		terminal to backside	12			mm
V_{ISOL}	isolation voltage	t = 1 second t = 1 minute	4300 3600			V V
$R_{pin-chip}$	resistance pin to chip	$V = V_{CEsat} + 2 \cdot R \cdot I_C$ resp. $V = V_F + 2 \cdot R \cdot I_F$				mΩ
C_P	coupling capacity per switch	between shorted pins of switch and back side metallization				pF

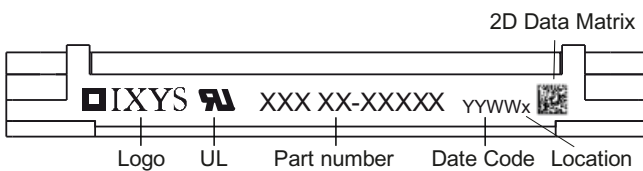

Part number

- M = Module
- I = IGBT
- X = XPT IGBT
- G = Gen 2 / std
- 240 = Current Rating [A]
- W = 6-pack
- 1200 = Reverse Voltage [V]
- PZT = PressFit Pin + Shunt 0.5mΩ, Thermistor
- EH = E3-Pack

Ordering	Part Name	Marking on Product	Delivering Mode	Base Qty	Ordering Code
Standard	MIXG240W1200PZTEH	MIXG240W1200PZTEH	Blister	24	522740
with Phase Change Material	MIXG240W1200PZTEH -PC	MIXG240W1200PZTEH	Blister	24	522733

Similar Part	Package	Voltage class
MIXG240W1200TEH	E3- Pack	1200
MIXG240W1200PTEH	E3- Pack, press fit pin	1200

Option: phase change material; please contact IXYS sales office for availability

Equivalent Circuits for Simulation *on die level

$V_{0\ max}$	threshold voltage	$T_{VJ} = 125^\circ\text{C}$	IGBT	Inverter Diode	V
$R_{0\ max}$	slope resistance *				mΩ
$V_{0\ max}$	threshold voltage	$T_{VJ} = 175^\circ\text{C}$	1.2	1.2	V
$R_{0\ max}$	slope resistance *		5.8	4.7	mΩ

Outlines E3-Pack

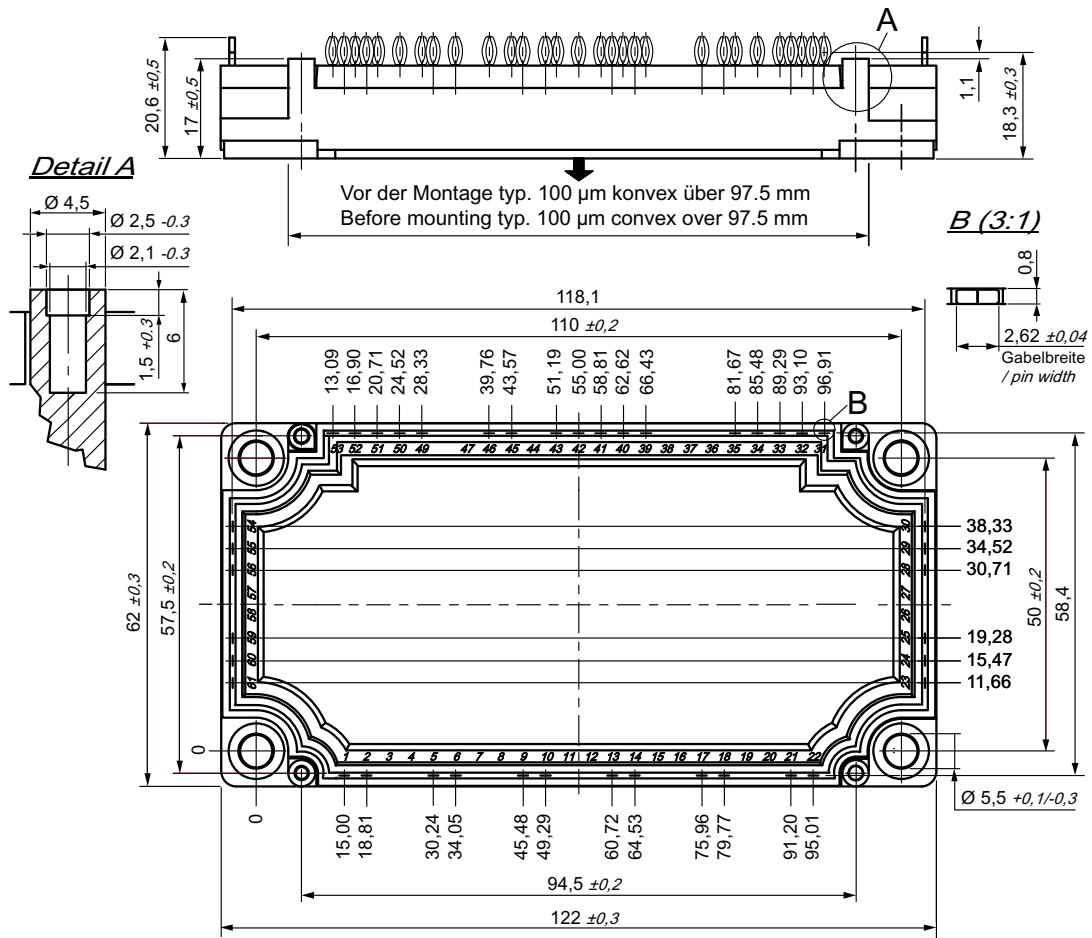

Bemerkung / Note:

- Nichttolerierete Maße nach / Measure without tolerances according DIN ISO 2768-T1-m
- PCB-Lochmuster / PCB hole pattern: **see pin position**
- Toleranz Pin-Position und PCB-Lochmuster / Tolerance of pin position and PCB hole pattern: $\oplus 0.1$
- Bohrlochdurchmesser / Diameter of drill: **Ø 2.35 mm**
- Endlochdurchmesser / Diameter of plated holes: **Ø 2.14 - 2.29 mm** (Cu thickness in via typ. 50 µm)
- Beschichtung / Plating: **chem. Sn max. 15 µm**
- Einpresskraft / Insert Force: per terminal with a typ. insert speed of 7 mm/s: **typ. 90 N**
- Weitere Angaben / Further information: www.ixys.com **Application note IXAN0077**
- Montageanleitung / Mounting instruction: www.ixys.com **Application note IXAN0024**

Detail A: PCB-Montage / Mounting on PCB

- Empfohlene, selbstschneidende Schraube / Recommended, self-tapping screw: **EJOT PT®** (Größe / size: **K25**)
- Max. Schraubenlänge / Max. screw length: **PCB-Dicke / thickness + 6 mm** (max. Lochtiefe / hole depth)
- Empfohlenes Drehmoment / Recommended mounting torque: **1.5 Nm**

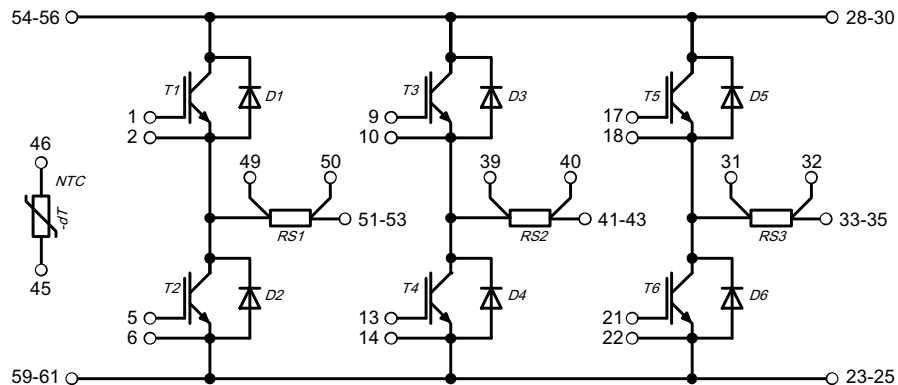

IGBT T1 - T6

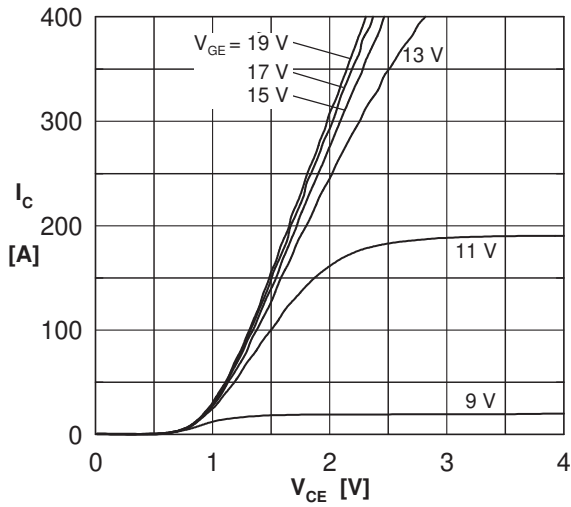

Fig. 1 Typ. output characteristics ($T_{VJ} = 25^{\circ}\text{C}$)

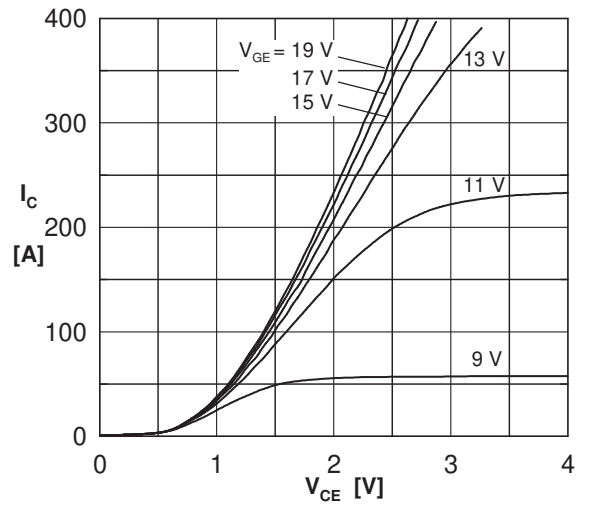

Fig. 2 Typ. output characteristics ($T_{VJ} = 150^{\circ}\text{C}$)

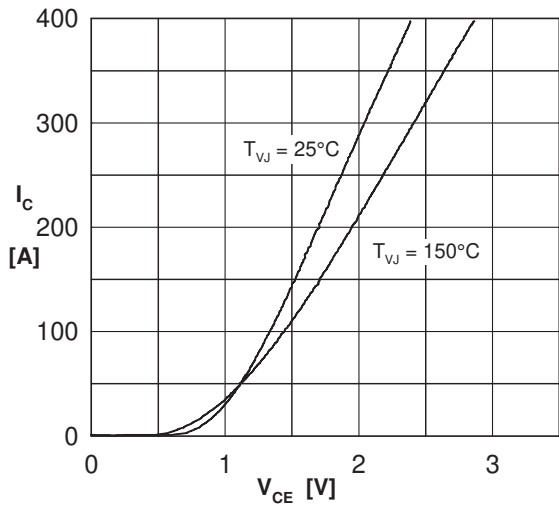

Fig. 3 Typ. output characteristics ($V_{GE} = 15\text{V}$)

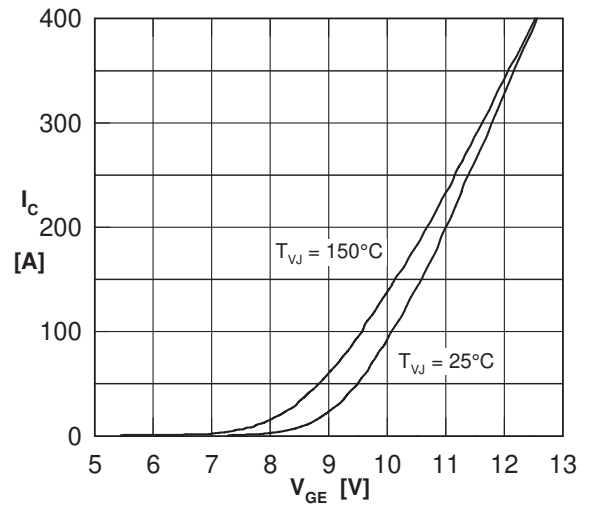

Fig. 4 Typ. transfer characteristics ($V_{CE} = 20\text{V}$)

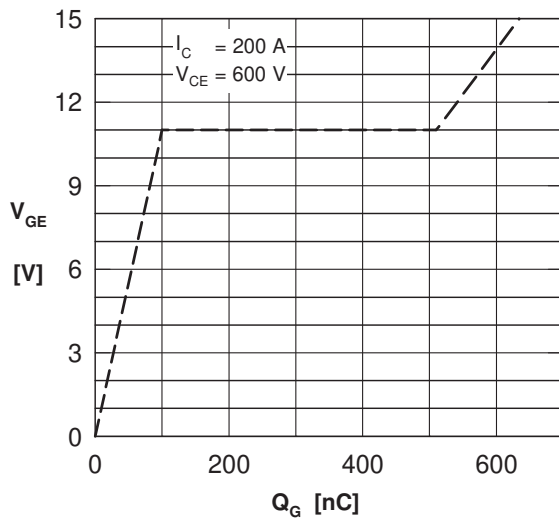

Fig. 5 Typ. turn-on gate charge 0/15V

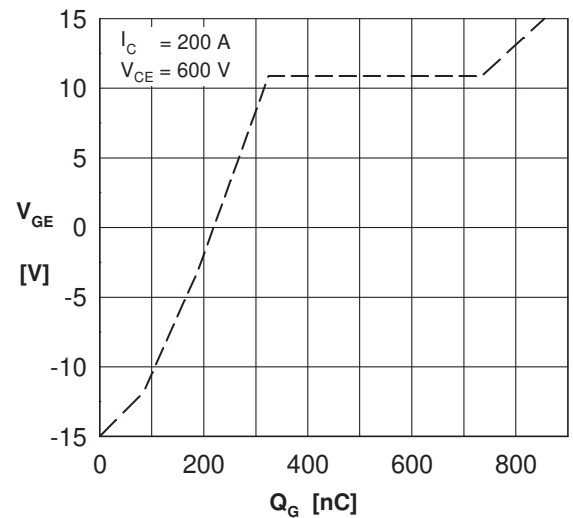

Fig. 6 Typ. turn-on gate charge -15/+15V

IGBT T1 - T6

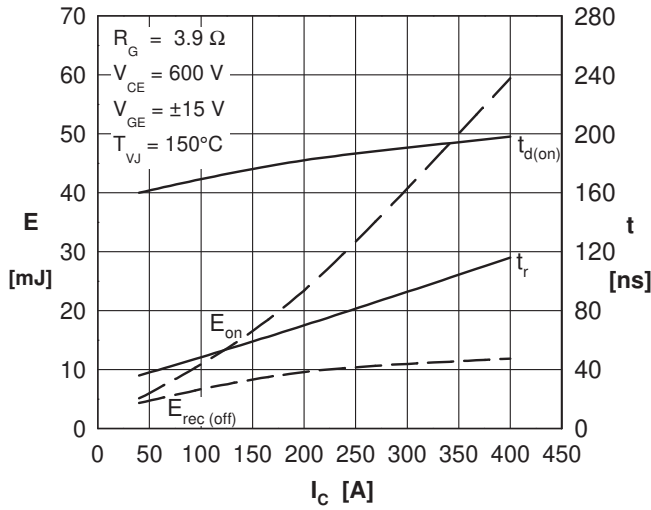

Fig. 7 Typ. switching energy versus collector current (turn on)

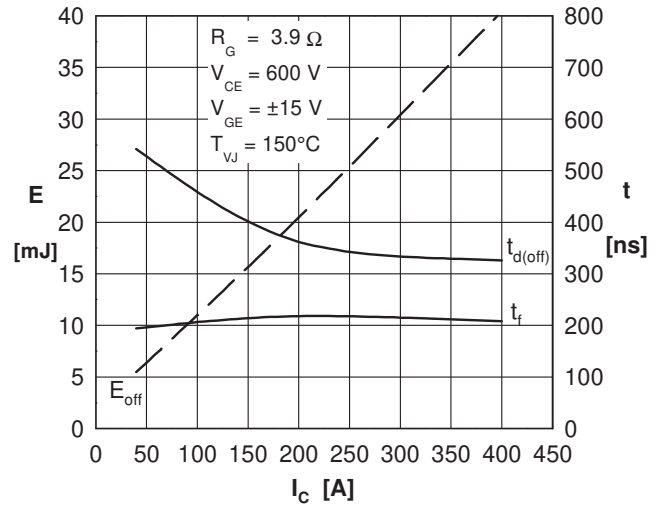

Fig. 8 Typ. switching energy versus collector current (turn off)

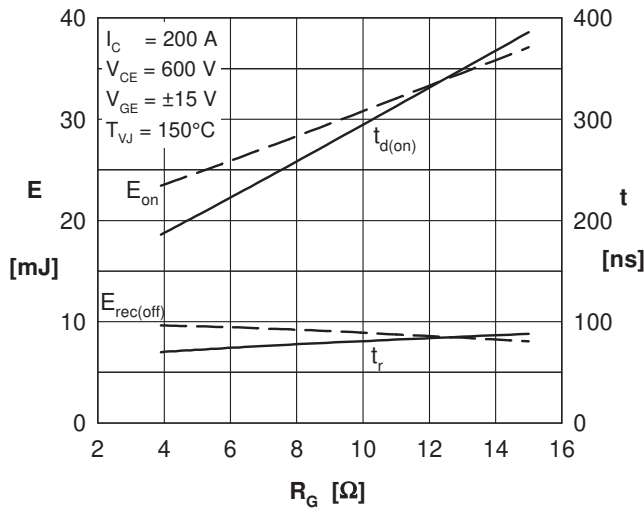

Fig. 9 Typ. switching energy versus gate resistor (turn on)

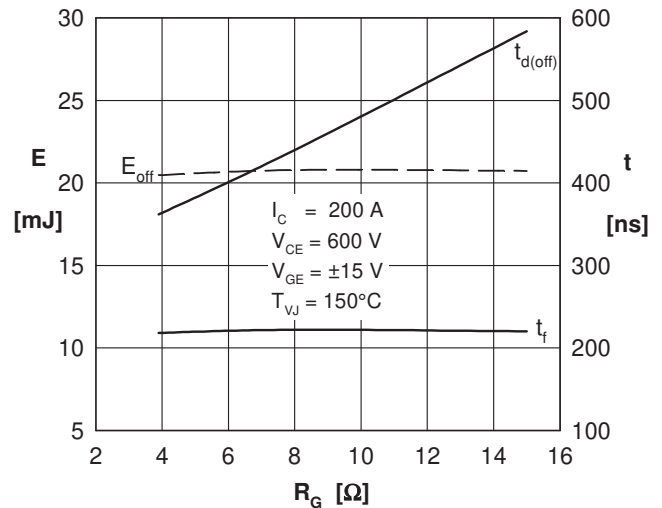

Fig. 10 Typ. switching energy versus gate resistor (turn off)

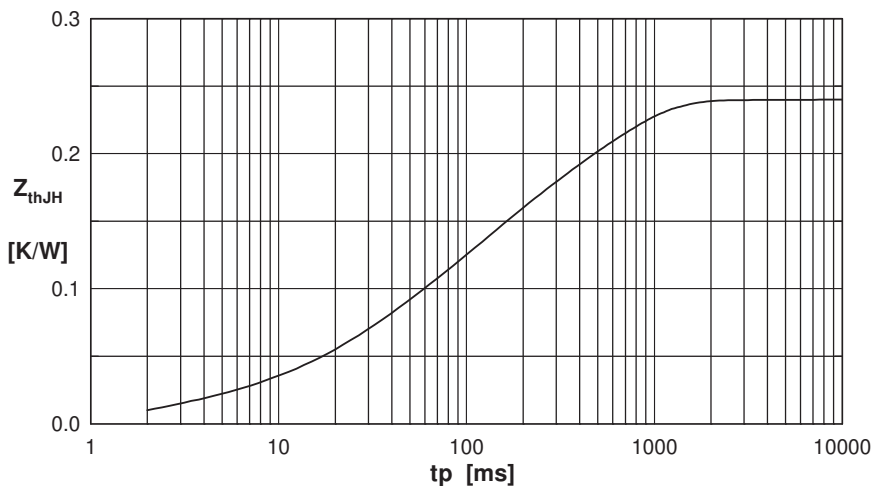
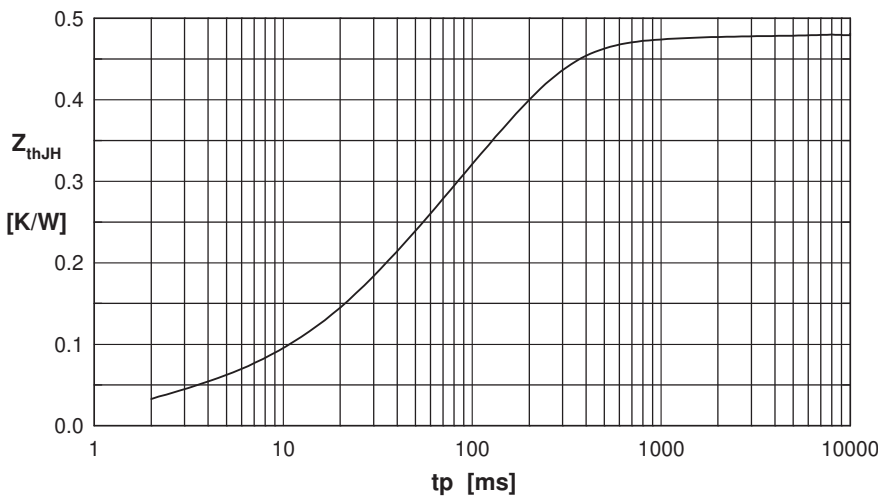
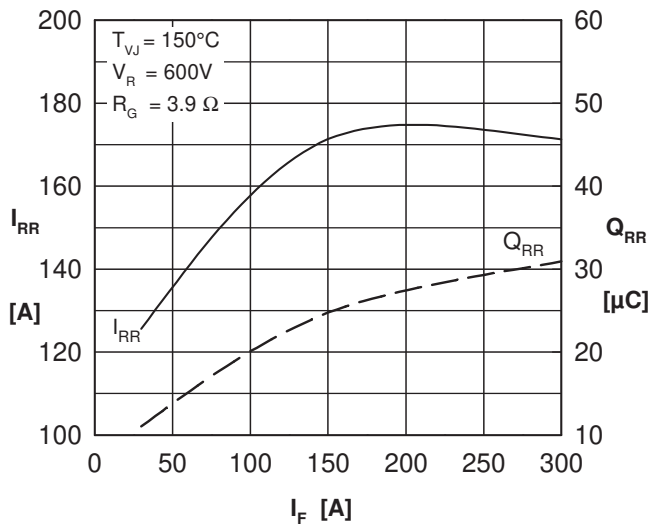
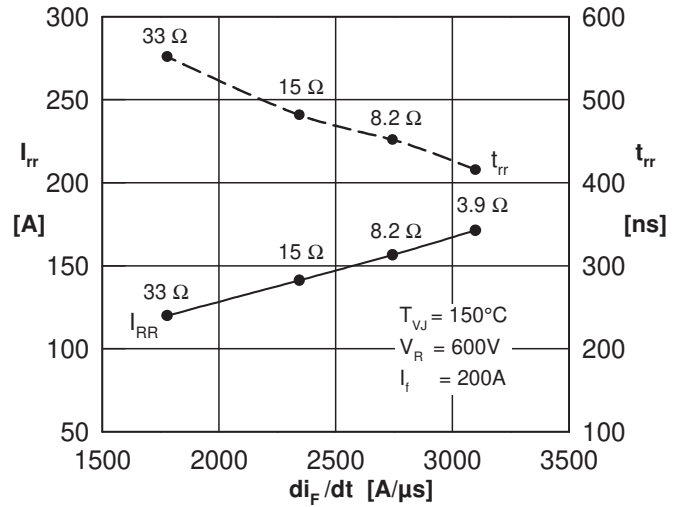
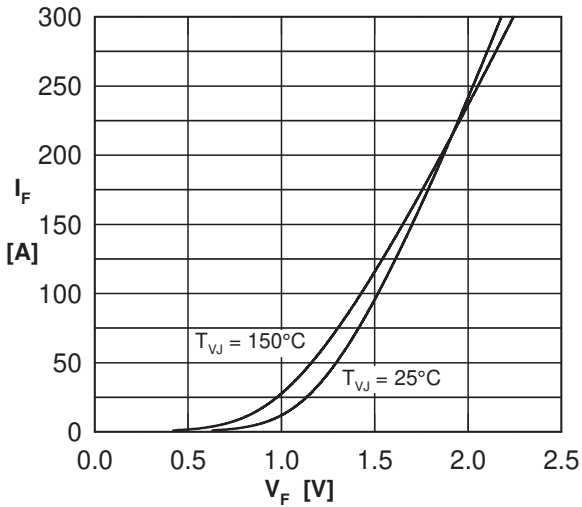

Fig. 11 IGBT: typ. transient thermal impedance to heat sink

DIODE D1 - D6



Данный компонент на территории Российской Федерации

Вы можете приобрести в компании MosChip.

Для оперативного оформления запроса Вам необходимо перейти по данной ссылке:

<http://moschip.ru/get-element>

Вы можете разместить у нас заказ для любого Вашего проекта, будь то серийное производство или разработка единичного прибора.

В нашем ассортименте представлены ведущие мировые производители активных и пассивных электронных компонентов.

Нашей специализацией является поставка электронной компонентной базы двойного назначения, продукции таких производителей как XILINX, Intel (ex.ALTERA), Vicor, Microchip, Texas Instruments, Analog Devices, Mini-Circuits, Amphenol, Glenair.

Сотрудничество с глобальными дистрибьюторами электронных компонентов, предоставляет возможность заказывать и получать с международных складов практически любой перечень компонентов в оптимальные для Вас сроки.

На всех этапах разработки и производства наши партнеры могут получить квалифицированную поддержку опытных инженеров.

Система менеджмента качества компании отвечает требованиям в соответствии с ГОСТ Р ИСО 9001, ГОСТ РВ 0015-002 и ЭС РД 009

Офис по работе с юридическими лицами:

105318, г.Москва, ул.Щербаковская д.3, офис 1107, 1118, ДЦ «Щербаковский»

Телефон: +7 495 668-12-70 (многоканальный)

Факс: +7 495 668-12-70 (доб.304)

E-mail: info@moschip.ru

Skype отдела продаж:

moschip.ru

moschip.ru_4

moschip.ru_6

moschip.ru_9