

## EMILY-D

~11° diffused spot beam. 14.74 mm high lens.

### TECHNICAL SPECIFICATIONS:

Dimensions	Ø 26.0 mm
Height	14.7 mm
Fastening	tape, pin
ROHS compliant	yes 

### MATERIAL SPECIFICATIONS:

Component	Type	Material	Colour	Finish
EMILY-D	Single lens	PMMA		
SPUTNIK-TAPE	Tape	PU tape		



### ORDERING INFORMATION:

Component		Qty in box	MOQ	MPQ	Box weight (kg)
CA12062_EMILY-D	Single lens	1690	260	130	10.5
» Box size: 480 x 280 x 300 mm					

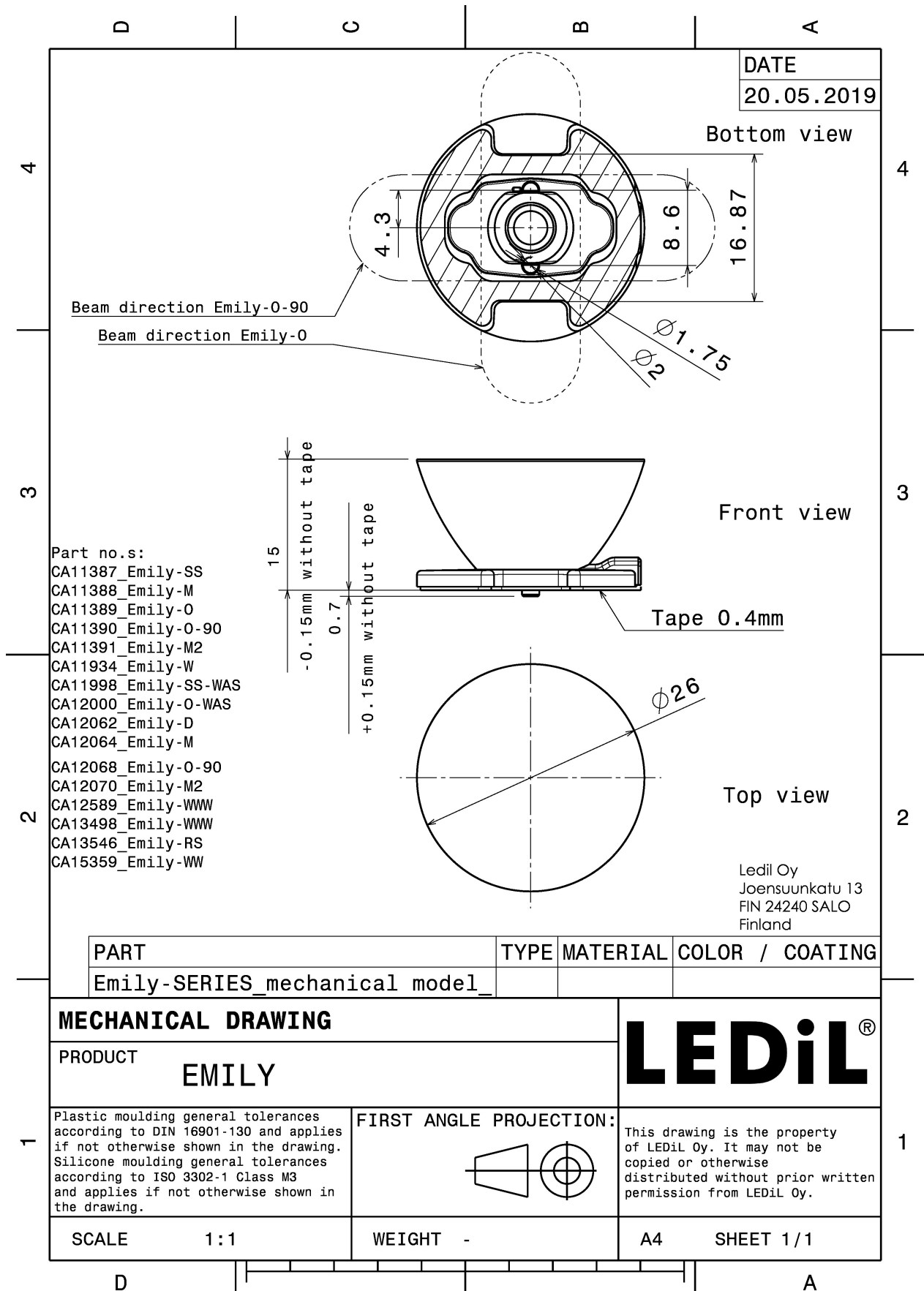

#### PHOTOMETRIC DATA (MEASURED):

#### CREE

LED XB-H  
 FWHM 10.0°  
 Efficiency 89 %  
 Peak intensity 17.500 cd/lm  
 LEDs/each optic 1  
 Light colour White  
 Required components:

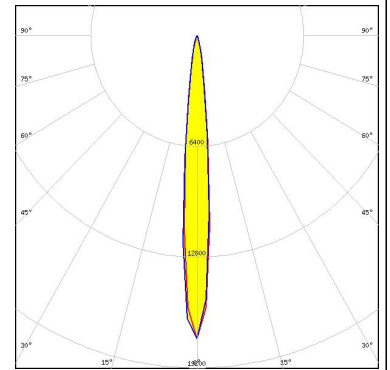

#### CREE

LED XD16  
 FWHM 8.0°  
 Efficiency 92 %  
 Peak intensity 18.400 cd/lm  
 LEDs/each optic 1  
 Light colour White  
 Required components:

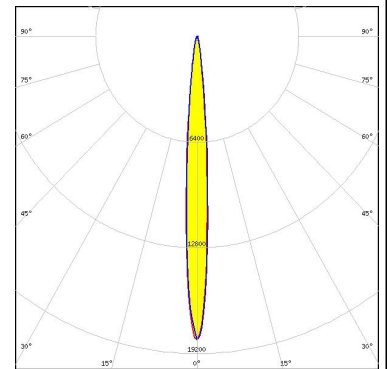

#### CREE

LED XHP35 HI  
 FWHM 11.0°  
 Efficiency 92 %  
 Peak intensity 14.500 cd/lm  
 LEDs/each optic 1  
 Light colour White  
 Required components:

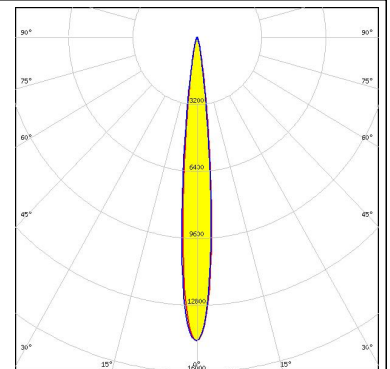

#### CREE

LED XM-L  
 FWHM 14.0°  
 Efficiency 90 %  
 Peak intensity 10.100 cd/lm  
 LEDs/each optic 1  
 Light colour White  
 Required components:

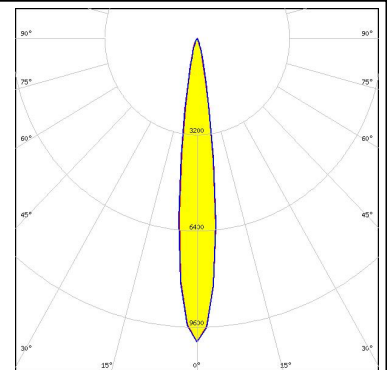

#### PHOTOMETRIC DATA (MEASURED):

#### CREE

LED XM-L2  
 FWHM 14.0°  
 Efficiency 90 %  
 Peak intensity 10.200 cd/lm  
 LEDs/each optic 1  
 Light colour White  
 Required components:

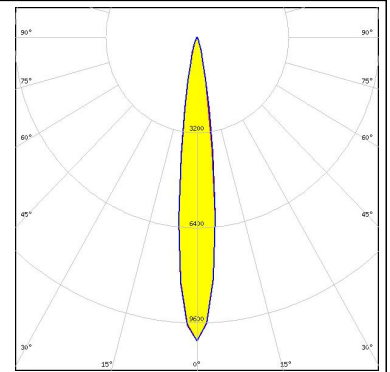

#### CREE

LED XP-E2  
 FWHM 8.0°  
 Efficiency 87 %  
 Peak intensity 27.300 cd/lm  
 LEDs/each optic 1  
 Light colour White  
 Required components:

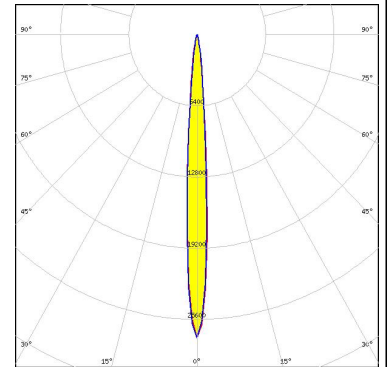

#### CREE

LED XP-G2  
 FWHM 10.0°  
 Efficiency 90 %  
 Peak intensity 20.800 cd/lm  
 LEDs/each optic 1  
 Light colour White  
 Required components:

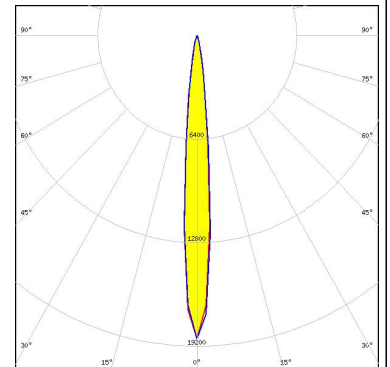
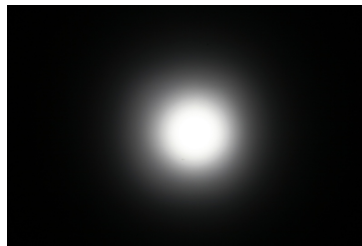

#### CREE

LED XP-G3  
 FWHM 11.0°  
 Efficiency 94 %  
 Peak intensity 13.000 cd/lm  
 LEDs/each optic 1  
 Light colour White  
 Required components:

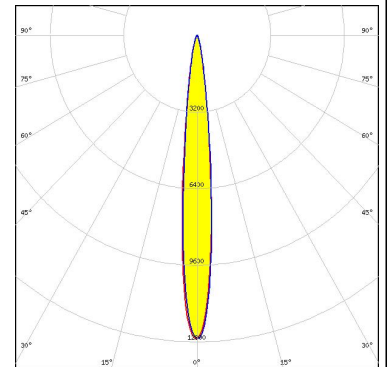

**PHOTOMETRIC DATA (MEASURED):**



LED XP-L HD  
 FWHM 13.0°  
 Efficiency 90 %  
 Peak intensity 10.200 cd/lm  
 LEDs/each optic 1  
 Light colour White  
 Required components:

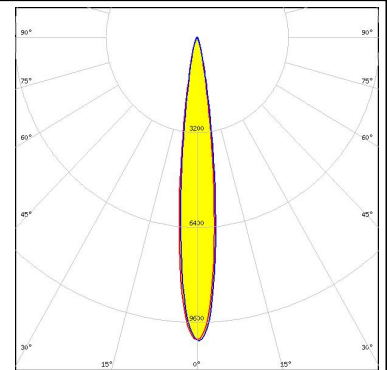

LED XP-L HI  
 FWHM 9.0°  
 Efficiency 87 %  
 Peak intensity 20.000 cd/lm  
 LEDs/each optic 1  
 Light colour White  
 Required components:

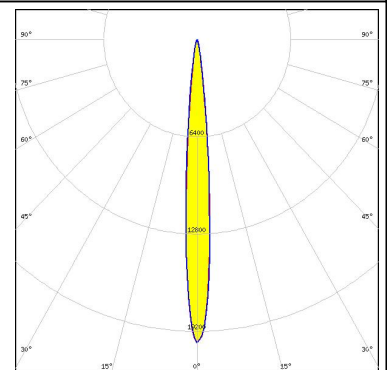

LED XT-E  
 FWHM 9.0°  
 Efficiency %  
 Peak intensity 14.000 cd/lm  
 LEDs/each optic 1  
 Light colour White  
 Required components:



LED LUXEON A  
 FWHM 11.0°  
 Efficiency 91 %  
 Peak intensity cd/lm  
 LEDs/each optic 1  
 Light colour White  
 Required components:

#### PHOTOMETRIC DATA (MEASURED):

#### LUMILEDS

LED LUXEON Rebel ES  
 FWHM 10.0°  
 Efficiency 91 %  
 Peak intensity cd/lm  
 LEDs/each optic 1  
 Light colour White  
 Required components:

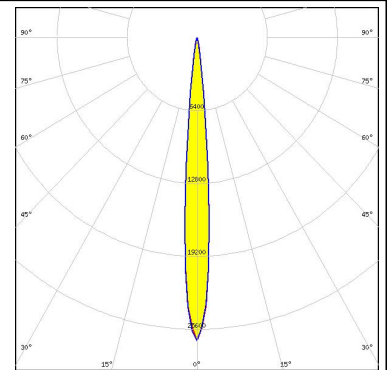

#### NICHIA

LED NS9x383  
 FWHM 14.0°  
 Efficiency 90 %  
 Peak intensity 7.900 cd/lm  
 LEDs/each optic 1  
 Light colour White  
 Required components:

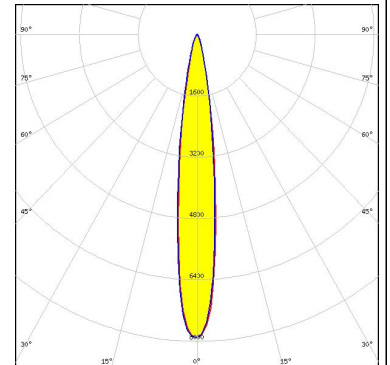

#### OSRAM

Opto Semiconductors  
 LED OSLOX Square EC  
 FWHM 9.0°  
 Efficiency 86 %  
 Peak intensity 20.060 cd/lm  
 LEDs/each optic 1  
 Light colour White  
 Required components:

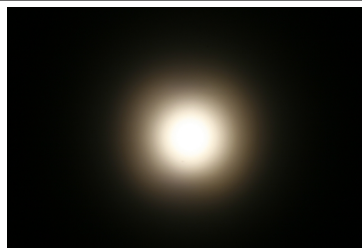

#### SAMSUNG

LED LH351B  
 FWHM 12.0°  
 Efficiency 88 %  
 Peak intensity 14.000 cd/lm  
 LEDs/each optic 1  
 Light colour White  
 Required components:

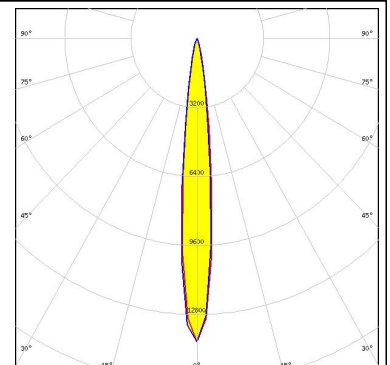

**PHOTOMETRIC DATA (MEASURED):**

**SAMSUNG**

LED LH351Z  
FWHM 10.0°  
Efficiency 88 %  
Peak intensity 20.000 cd/lm  
LEDs/each optic 1  
Light colour White  
Required components:

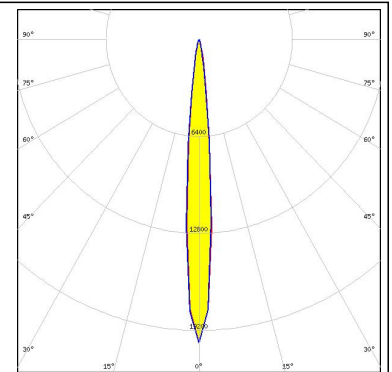

SEOUL SEMICONDUCTOR  
LED Z5M1/Z5M2  
FWHM 10.0°  
Efficiency 94 %  
Peak intensity 18.200 cd/lm  
LEDs/each optic 1  
Light colour White  
Required components:

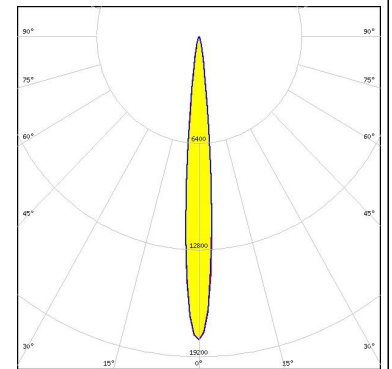

SEOUL SEMICONDUCTOR  
LED Z8Y22P  
FWHM 11.0°  
Efficiency 93 %  
Peak intensity 11.300 cd/lm  
LEDs/each optic 1  
Light colour White  
Required components:

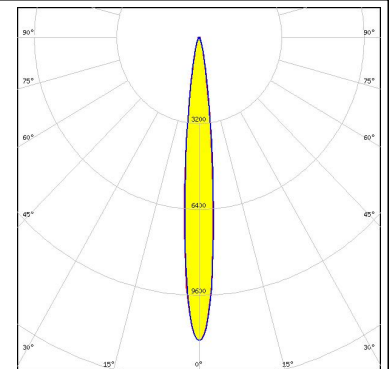
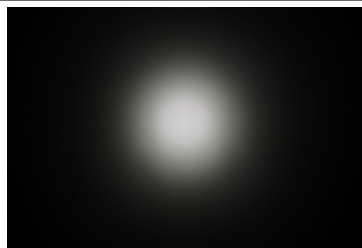



#### PHOTOMETRIC DATA (SIMULATED):

**CREE** 

LED XM-L HVW  
 FWHM 14.0°  
 Efficiency %  
 Peak intensity cd/lm  
 LEDs/each optic 1  
 Light colour White  
 Required components:

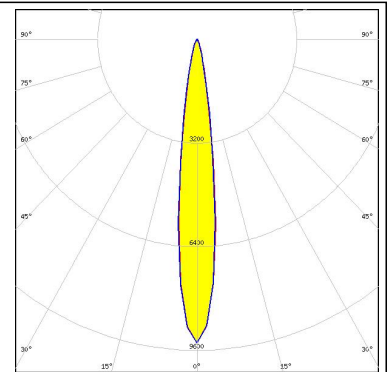

**CREE** 

LED XP-G2 HE  
 FWHM 12.0°  
 Efficiency 95 %  
 Peak intensity 15.232 cd/lm  
 LEDs/each optic 1  
 Light colour White  
 Required components:

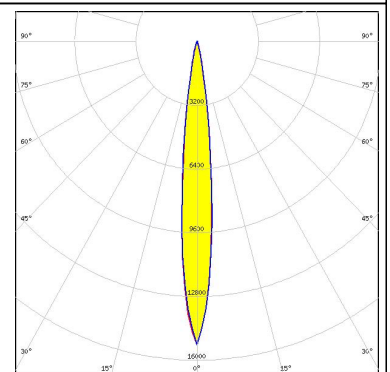

**OSRAM**  
Opto Semiconductors

LED OSLON Square CSSRM2/CSSRM3  
 FWHM 9.9°  
 Efficiency 94 %  
 Peak intensity 22.500 cd/lm  
 LEDs/each optic 1  
 Light colour White  
 Required components:

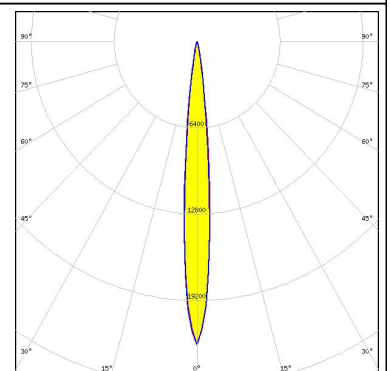



### GENERAL INFORMATION:

NOTE: The typical beam angle will be changed by different color, chip size and chip position tolerance. The typical total beam angle is the full angle measured where the luminous intensity is half of the peak value.

### MATERIALS:

As part of our continuous research and improvement processes, and to ensure the best possible quality and availability of our products, LEDiL reserves the right to change material grades without notice.

### PRODUCT DATA USER AGREEMENT AND DISCLAIMER:

The measured data in the provided downloadable LEDiL Product Datasheets and Mechanical 2D-Drawings is rounded and provided as reference for planning. LEDiL Oy's optical specifications have been verified by conducting performance testing of the products in accordance with the company's quality system. The reported data are averaged results of multiple measurements with typical variation. LEDiL Oy reserves the right to without prior notification make changes and improvements to its products.

LEDiL Oy assumes neither warranty, nor guarantee nor any other liability of any kind for the contents and correctness of the provided data. The provided data has been generated with highest diligence but the provided data may in reality not represent the complete possible variation range of all intrinsic parameters. Therefore, in certain cases a deviation from the provided data could occur.

LEDiL Oy reserves the right to undertake technical changes of its products without further notification which could lead to changes in the provided data. LEDiL Oy assumes no liability of any kind for the possible deviation from any provided data or any other damage resulting from the usage of the provided data.

The user agrees to this disclaimer and user agreement with the download or usage of the provided files.

#### LEDiL Oy

Joensuunkatu 13  
FI-24240 SALO  
Finland

#### LEDiL Inc.

228 West Page Street  
Suite D  
Sycamore IL 60178  
USA

#### Local sales and technical support

[www.ledil.com/  
where\\_to\\_buy](http://www.ledil.com/where_to_buy)

#### Shipping locations

Salo, Finland  
Hong Kong, China

#### Distribution Partners

[www.ledil.com/  
where\\_to\\_buy](http://www.ledil.com/where_to_buy)

## Данный компонент на территории Российской Федерации

### Вы можете приобрести в компании MosChip.

Для оперативного оформления запроса Вам необходимо перейти по данной ссылке:

<http://moschip.ru/get-element>

Вы можете разместить у нас заказ для любого Вашего проекта, будь то серийное производство или разработка единичного прибора.

В нашем ассортименте представлены ведущие мировые производители активных и пассивных электронных компонентов.

Нашей специализацией является поставка электронной компонентной базы двойного назначения, продукции таких производителей как XILINX, Intel (ex.ALTERA), Vicor, Microchip, Texas Instruments, Analog Devices, Mini-Circuits, Amphenol, Glenair.

Сотрудничество с глобальными дистрибьюторами электронных компонентов, предоставляет возможность заказывать и получать с международных складов практически любой перечень компонентов в оптимальные для Вас сроки.

На всех этапах разработки и производства наши партнеры могут получить квалифицированную поддержку опытных инженеров.

Система менеджмента качества компании отвечает требованиям в соответствии с ГОСТ Р ИСО 9001, ГОСТ РВ 0015-002 и ЭС РД 009

### Офис по работе с юридическими лицами:

105318, г.Москва, ул.Щербаковская д.3, офис 1107, 1118, ДЦ «Щербаковский»

Телефон: +7 495 668-12-70 (многоканальный)

Факс: +7 495 668-12-70 (доб.304)

E-mail: [info@moschip.ru](mailto:info@moschip.ru)

Skype отдела продаж:

moschip.ru

moschip.ru\_4

moschip.ru\_6

moschip.ru\_9