

**60V DUAL N-CHANNEL SELF PROTECTED ENHANCEMENT MODE  
INTELLIFET® MOSFET**

**Product Summary**

- Continuous drain source voltage 60V
- On-state resistance 100mΩ
- Nominal load current ( $V_{IN} = 5V$ ) 2.8A
- Clamping Energy 210mJ

**Description and Applications**

The ZXMS6006DT8 is a dual self protected low side MOSFET with logic level input. It integrates over-temperature, over-current, over-voltage (active clamp) and ESD protected logic level functionality. The ZXMS6006DT8 is ideal as a general purpose switch driven from 3.3V or 5V microcontrollers in harsh environments where standard MOSFETs are not rugged enough.

- Lamp Driver
- Motor Driver
- Relay Driver
- Solenoid Driver

**Features and Benefits**

- Compact high power dissipation package
- Low input current
- Logic Level Input (3.3V and 5V)
- Short circuit protection with auto restart
- Over voltage protection (active clamp)
- Thermal shutdown with auto restart
- Over-current protection
- Input Protection (ESD)
- High continuous current rating
- **Green, RoHS Compliant (Note 1)**
- **Halogen and Antimony Free. (Note 2)**
- **Qualified to AEC-Q101 Standards for High Reliability**

**Mechanical Data**

- Case: SM-8
- Case Material: Molded Plastic, "Green" Molding Compound. UL Flammability Classification Rating 94V-0
- Moisture Sensitivity: Level 1 per J-STD-020
- Terminals: Matte Tin Finish
- Weight: 0.117 grams (approximate)



Top View

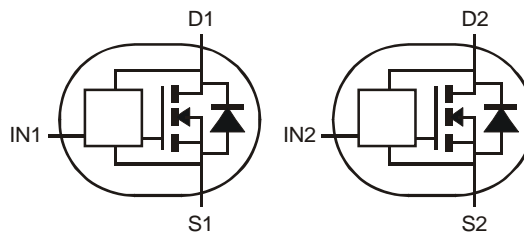

Device symbol

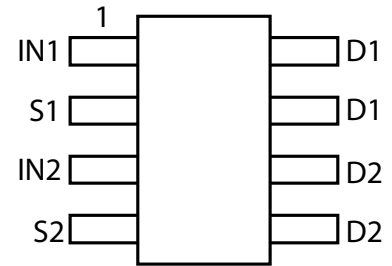

Top view  
Pin-Out

**Ordering Information** (Note 3)

Product	Marking	Reel size (inches)	Tape width (mm)	Quantity per reel
ZXMS6006DT8TA	ZXMS6006D	7	12	1,000

- Notes:
1. Contain <900ppm bromine, chlorine (<1500ppm total) and <1000ppm antimony compounds.
  2. Diodes Inc's "Green" Policy can be found on our website at <http://www.diodes.com>
  3. For packaging details, go to our website at <http://www.diodes.com>

**Marking Information**

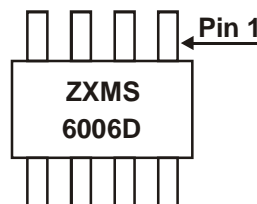

Top View

ZXMS6006D = Product Type Marking Code

IntelliFET® is a trademark of Diodes Incorporated, registered in the United States and other jurisdictions worldwide.

**Functional Block Diagram**

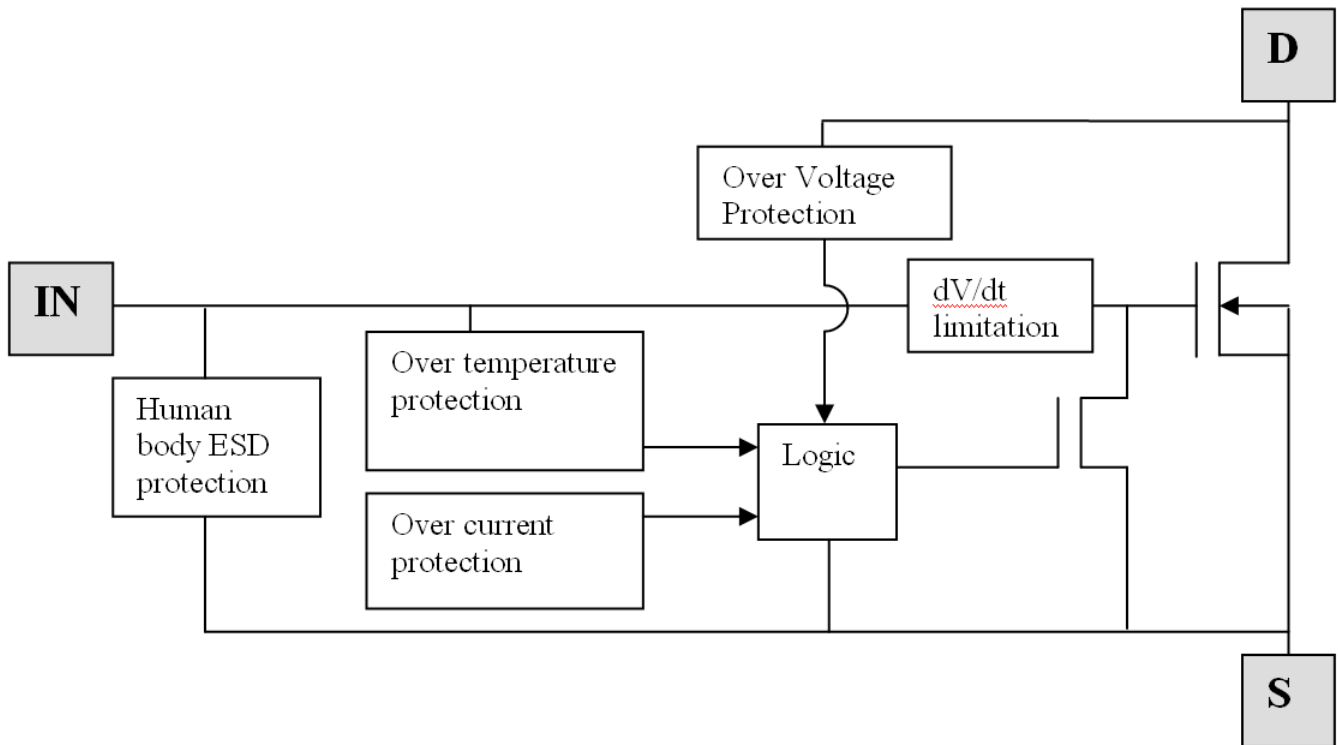

**Maximum Ratings** @T<sub>A</sub> = 25°C unless otherwise specified

Characteristic	Symbol	Value	Units
Continuous Drain-Source Voltage	V <sub>DS</sub>	60	V
Drain-Source Voltage For Short Circuit Protection	V <sub>DS(SC)</sub>	16	V
Continuous Input Voltage	V <sub>IN</sub>	-0.5 ... +6	V
Continuous Input Current @ -0.2V ≤ V <sub>IN</sub> ≤ 6V	I <sub>IN</sub>	No limit	mA
Continuous Input Current @ V <sub>IN</sub> < -0.2V or V <sub>IN</sub> > 6V		I <sub>IN</sub>   ≤ 2	
Pulsed Drain Current @ V <sub>IN</sub> = 3.3V ( Note 6)	I <sub>DM</sub>	11	A
Pulsed Drain Current @ V <sub>IN</sub> = 5V ( Note 6)	I <sub>DM</sub>	13	A
Continuous Source Current (Body Diode) (Note 4)	I <sub>S</sub>	2	A
Pulsed Source Current (Body Diode)	I <sub>SM</sub>	12	A
Unclamped Single Pulse Inductive Energy, T <sub>J</sub> = 25°C, I <sub>D</sub> = 0.5A, V <sub>DD</sub> = 24V	E <sub>AS</sub>	210	mJ
Electrostatic Discharge (Human Body Model)	V <sub>ESD</sub>	4000	V
Charged Device Model	V <sub>CDM</sub>	1000	V

**Thermal Characteristics** @T<sub>A</sub> = 25°C unless otherwise specified

Characteristic	Symbol	Value	Units
Power Dissipation at T <sub>A</sub> = 25°C (Notes 4 & 7)	P <sub>D</sub>	1.16	W
Linear Derating Factor		9.28	mW/°C
Power Dissipation at T <sub>A</sub> = 25°C (Notes 4 & 8)	P <sub>D</sub>	1.67	W
Linear Derating Factor		13.3	mW/°C
Power Dissipation at T <sub>A</sub> = 25°C (Notes 5 & 7)	P <sub>D</sub>	2.13	W
Linear Derating Factor		17	mW/°C
Thermal Resistance, Junction to Ambient (Notes 4 & 7)	R <sub>θJA</sub>	108	°C/W
Thermal Resistance, Junction to Ambient (Notes 4 & 8)	R <sub>θJA</sub>	75	°C/W
Thermal Resistance, Junction to Case (Notes 5 & 7)	R <sub>θJC</sub>	58.7	°C/W
Thermal Resistance, Junction to Case (Note 9)	R <sub>θJC</sub>	26.5	°C/W
Operating Temperature Range	T <sub>J</sub>	-40 to +150	°C
Storage Temperature Range	T <sub>STG</sub>	-55 to +150	°C

- Notes:
- For a dual device surface mounted on a 25mm x 25mm single sided 1oz weight copper split down the middle on 1.6mm FR4 board, in still air conditions.
  - For a dual device surface mounted on FR4 PCB measured at t<sub>s</sub> ≤ 10sec
  - Repetitive rating 25mm x 25mm FR4 PCB, D = 0.02, Pulse width = 300μs – pulse width limited by junction temperature. Refer to transient thermal impedance graph.
  - For a dual device with one active die.
  - For a dual device with 2 active die running at equal power.
  - Thermal resistance from junction to the mounting surface of the drain pin.

## Recommended Operating Conditions

The ZXMS6006DT8 is optimized for use with  $\mu\text{C}$  operating from 3.3V and 5V supplies.

Characteristic	Symbol	Min	Max	Unit
Input Voltage Range	$V_{\text{IN}}$	0	5.5	V
Ambient Temperature Range	$T_{\text{A}}$	-40	125	$^{\circ}\text{C}$
High Level Input Voltage for MOSFET to be on	$V_{\text{IH}}$	3	5.5	V
Low Level Input Voltage for MOSFET to be off	$V_{\text{IL}}$	0	0.7	V
Peripheral Supply Voltage (voltage to which load is referred)	$V_{\text{P}}$	0	16	V

## Thermal Characteristics

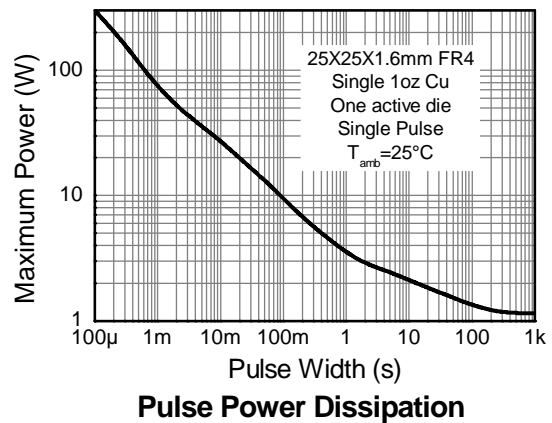
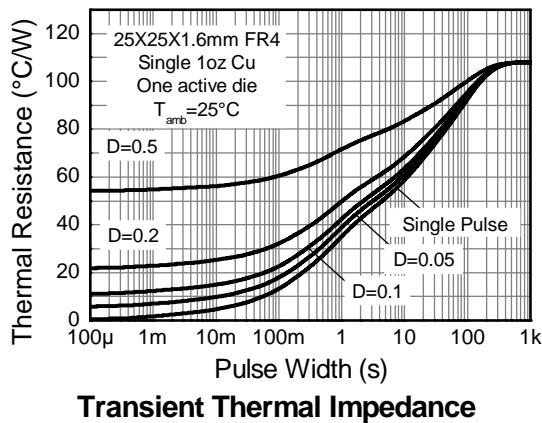
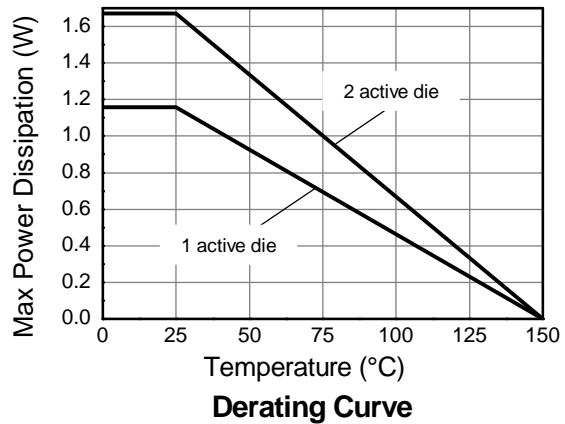
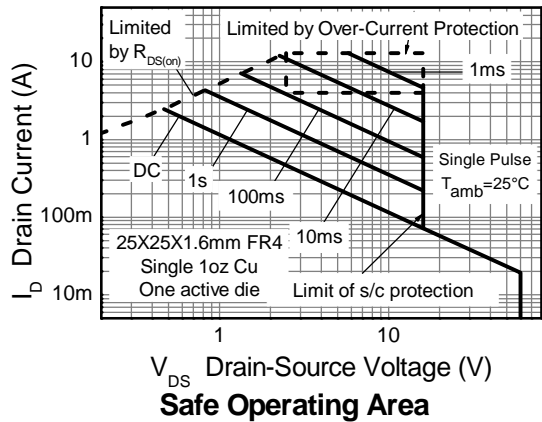

**Electrical Characteristics** @T<sub>A</sub> = 25°C unless otherwise specified

Characteristic	Symbol	Min	Typ	Max	Unit	Test Condition
<b>Static Characteristics</b>						
Drain-Source Clamp Voltage	V <sub>DS(AZ)</sub>	60	65	70	V	I <sub>D</sub> = 10mA
Off State Drain Current	I <sub>DSS</sub>	-	-	1	μA	V <sub>DS</sub> = 12V, V <sub>IN</sub> = 0V
		-	-	2		V <sub>DS</sub> = 36V, V <sub>IN</sub> = 0V
Input Threshold Voltage	V <sub>IN(th)</sub>	0.7	1	1.5	V	V <sub>DS</sub> = V <sub>GS</sub> , I <sub>D</sub> = 1mA
Input Current	I <sub>IN</sub>	-	60	100	μA	V <sub>IN</sub> = +3V
		-	120	200		V <sub>IN</sub> = +5V
Input Current while Over Temperature Active	-	-	-	400	μA	V <sub>IN</sub> = +5V
Static Drain-Source On-State Resistance	R <sub>DS(on)</sub>	-	85	125	mΩ	V <sub>IN</sub> = +3V, I <sub>D</sub> = 1A
		-	75	100		V <sub>IN</sub> = +5V, I <sub>D</sub> = 1A
Continuous Drain Current (Notes 4 & 8)	I <sub>D</sub>	2.0	-	-	A	V <sub>IN</sub> = 3V; T <sub>A</sub> = 25°C
Continuous Drain Current (Notes 4 & 7)		2.2	-	-		V <sub>IN</sub> = 5V; T <sub>A</sub> = 25°C
		2.6	-	-		V <sub>IN</sub> = 3V; T <sub>A</sub> = 25°C
		2.8	-	-		V <sub>IN</sub> = 5V; T <sub>A</sub> = 25°C
Current Limit (Note 10)	I <sub>D(LIM)</sub>	4	8	-	A	V <sub>IN</sub> = +3V
		6	13	-		V <sub>IN</sub> = +5V
<b>Dynamic Characteristics</b>						
Turn On Delay Time	t <sub>d(on)</sub>	-	8.6	-	μs	V <sub>DD</sub> = 12V, I <sub>D</sub> = 1A, V <sub>GS</sub> = 5V
Rise Time	t <sub>r</sub>	-	18	-	μs	
Turn Off Delay Time	t <sub>d(off)</sub>	-	34	-	μs	
Fall Time	t <sub>f</sub>	-	15	-	μs	
<b>Over-Temperature Protection</b>						
Thermal Overload Trip Temperature (Note 11)	T <sub>JT</sub>	150	175	-	°C	-
Thermal Hysteresis (Note 11)	f <sub>f</sub>	-	10	-	°C	-

- Notes:
- The drain current is restricted only when the device is in saturation (see graph 'typical output characteristic'). This allows the device to be used in the fully on state without interference from the current limit. The device is fully protected at all drain currents, as the low power dissipation generated outside saturation makes current limit unnecessary.
  - Over-temperature protection is designed to prevent device destruction under fault conditions. Fault conditions are considered as "outside" normal operating range, so this part is not designed to withstand over-temperature for extended periods..

**Typical Characteristics**

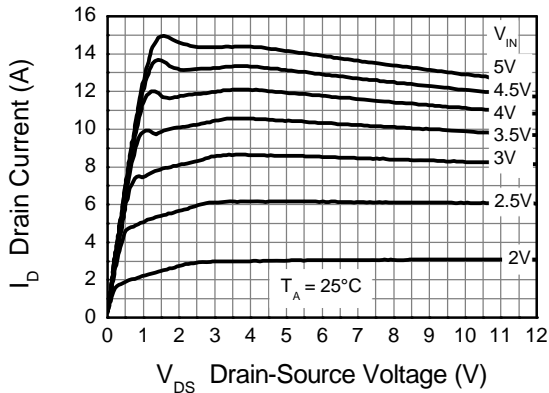

**Typical Output Characteristic**

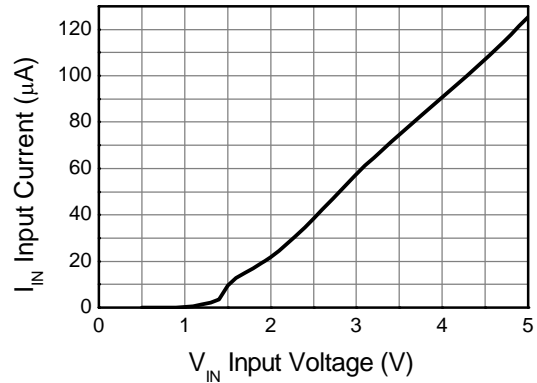

**Input Current vs Input Voltage**

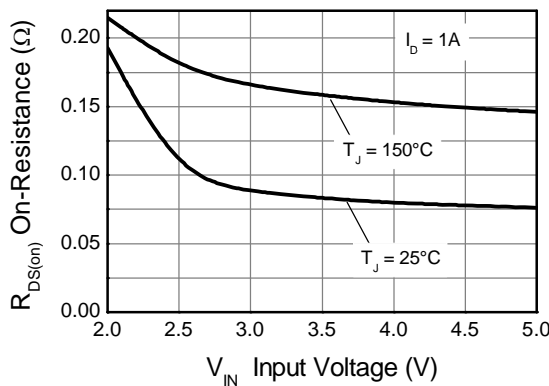

**On-Resistance vs Input Voltage**

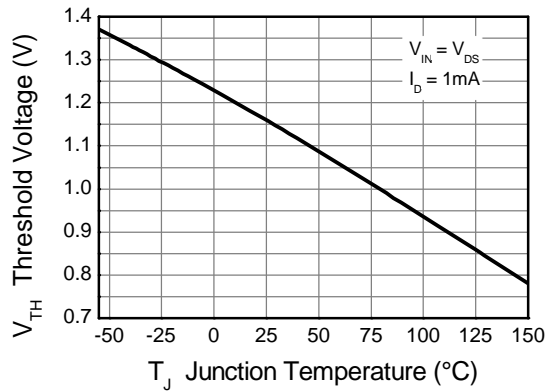

**Threshold Voltage vs Temperature**

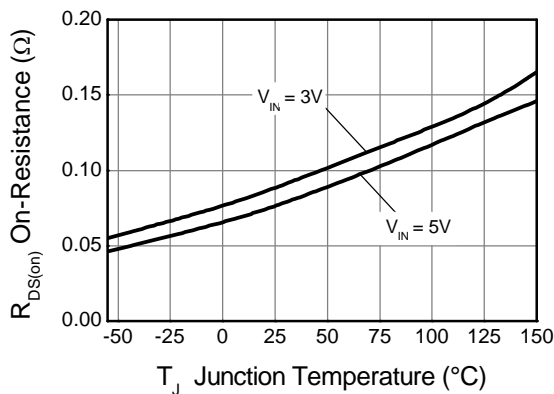

**On-Resistance vs Temperature**

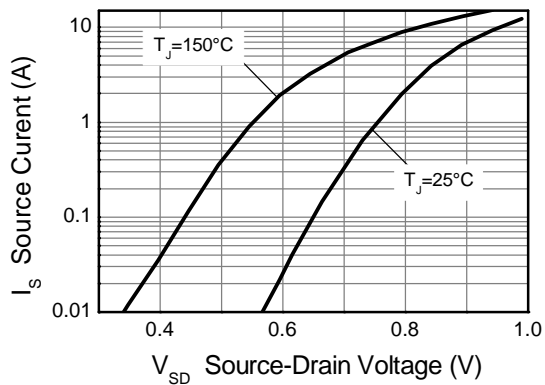

**Reverse Diode Characteristic**

**Typical Characteristics - Continued**

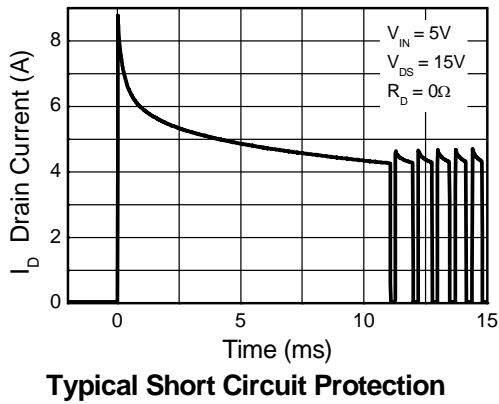
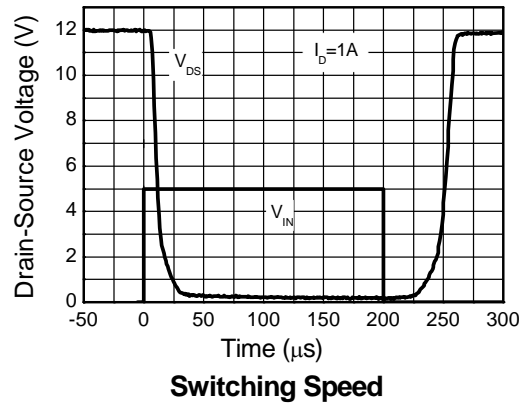
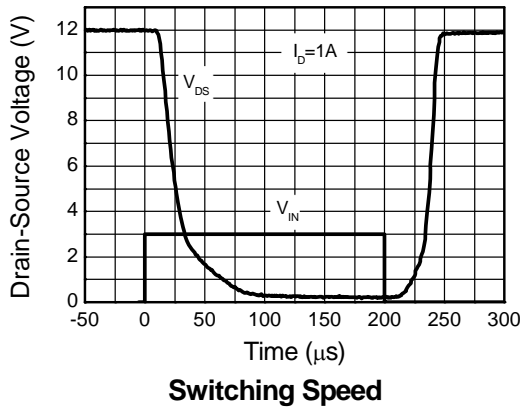

**Package Outline Dimensions**

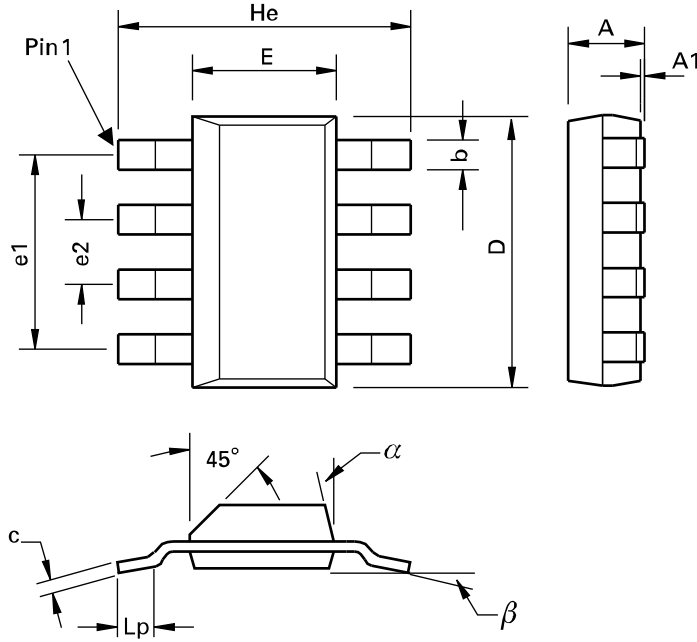

DIM	Millimeters			Inches			DIM	Millimeters			Inches		
	Min	Max	Typ.	Min	Max	Typ.		Min	Max	Typ.	Min	Max	Typ.
A	-	1.7	-	-	0.067	-	e1	-	-	4.59	-	-	0.1807
A1	0.02	0.1	-	0.008	0.004	-	e2	-	-	1.53	-	-	0.0602
b	-	-	0.7	-	-	0.0275	He	6.7	7.3	-	0.264	0.287	-
c	0.24	0.32	-	0.009	0.013	-	Lp	0.9	-	-	0.035	-	-
D	6.3	6.7	-	0.248	0.264	-	α	-	15°	-	-	15°	-
E	3.3	3.7	-	0.130	0.145	-	β	-	-	10°	-	-	10°

**Suggested Pad Layout**

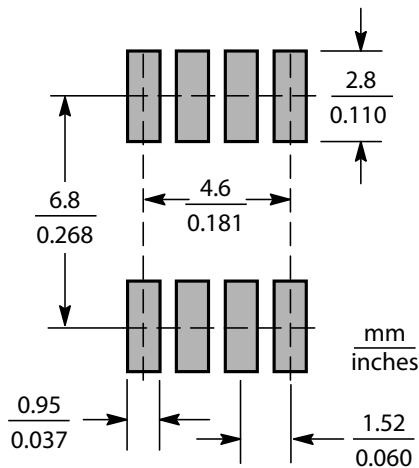



**IMPORTANT NOTICE**

DIODES INCORPORATED MAKES NO WARRANTY OF ANY KIND, EXPRESS OR IMPLIED, WITH REGARDING TO THIS DOCUMENT, INCLUDING, BUT NOT LIMITED TO, THE IMPLIED WARRANTIES OF MERCHANTABILITY AND FITNESS FOR A PARTICULAR PURPOSE (AND THEIR EQUIVALENTS UNDER THE LAWS OF ANY JURISDICTION).

Diodes Incorporated and its subsidiaries reserve the right to make modifications, enhancements, improvements, corrections or other changes without further notice to this document and any product described herein. Diodes Incorporated does not assume any liability arising out of the application or use of this document or any product described herein; neither does Diodes Incorporated convey any license under its patent or trademark rights, nor the rights of others. Any Customer or user of this document or products described herein in such applications shall assume all risks of such use and will agree to hold Diodes Incorporated and all the companies whose products are represented on Diodes Incorporated website, harmless against all damages.

Diodes Incorporated does not warrant or accept any liability whatsoever in respect of any products purchased through unauthorized sales channel. Should Customers purchase or use Diodes Incorporated products for any unintended or unauthorized application, Customers shall indemnify and hold Diodes Incorporated and its representatives harmless against all claims, damages, expenses, and attorney fees arising out of, directly or indirectly, any claim of personal injury or death associated with such unintended or unauthorized application.

Products described herein may be covered by one or more United States, international or foreign patents pending. Product names and markings noted herein may also be covered by one or more United States, international or foreign trademarks.

**LIFE SUPPORT**

Diodes Incorporated products are specifically not authorized for use as critical components in life support devices or systems without the express written approval of the Chief Executive Officer of Diodes Incorporated. As used herein:

A. Life support devices or systems are devices or systems which:

1. are intended to implant into the body, or
2. support or sustain life and whose failure to perform when properly used in accordance with instructions for use provided in the labeling can be reasonably expected to result in significant injury to the user.

B. A critical component is any component in a life support device or system whose failure to perform can be reasonably expected to cause the failure of the life support device or to affect its safety or effectiveness.

Customers represent that they have all necessary expertise in the safety and regulatory ramifications of their life support devices or systems, and acknowledge and agree that they are solely responsible for all legal, regulatory and safety-related requirements concerning their products and any use of Diodes Incorporated products in such safety-critical, life support devices or systems, notwithstanding any devices- or systems-related information or support that may be provided by Diodes Incorporated. Further, Customers must fully indemnify Diodes Incorporated and its representatives against any damages arising out of the use of Diodes Incorporated products in such safety-critical, life support devices or systems.

Copyright © 2010, Diodes Incorporated

[www.diodes.com](http://www.diodes.com)

## Данный компонент на территории Российской Федерации

### Вы можете приобрести в компании MosChip.

Для оперативного оформления запроса Вам необходимо перейти по данной ссылке:

<http://moschip.ru/get-element>

Вы можете разместить у нас заказ для любого Вашего проекта, будь то серийное производство или разработка единичного прибора.

В нашем ассортименте представлены ведущие мировые производители активных и пассивных электронных компонентов.

Нашей специализацией является поставка электронной компонентной базы двойного назначения, продукции таких производителей как XILINX, Intel (ex.ALTERA), Vicor, Microchip, Texas Instruments, Analog Devices, Mini-Circuits, Amphenol, Glenair.

Сотрудничество с глобальными дистрибьюторами электронных компонентов, предоставляет возможность заказывать и получать с международных складов практически любой перечень компонентов в оптимальные для Вас сроки.

На всех этапах разработки и производства наши партнеры могут получить квалифицированную поддержку опытных инженеров.

Система менеджмента качества компании отвечает требованиям в соответствии с ГОСТ Р ИСО 9001, ГОСТ РВ 0015-002 и ЭС РД 009

### Офис по работе с юридическими лицами:

105318, г.Москва, ул.Щербаковская д.3, офис 1107, 1118, ДЦ «Щербаковский»

Телефон: +7 495 668-12-70 (многоканальный)

Факс: +7 495 668-12-70 (доб.304)

E-mail: [info@moschip.ru](mailto:info@moschip.ru)

Skype отдела продаж:

moschip.ru

moschip.ru\_4

moschip.ru\_6

moschip.ru\_9