

30 V, 2 A low drop power Schottky rectifier

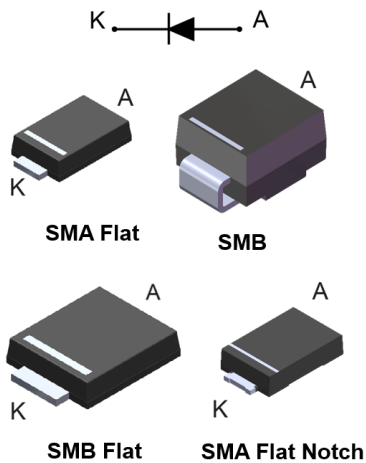

Features

- Low forward voltage drop for less power dissipation
- Optimized conduction/reverse losses trade-off which lead to the highest efficiency in the applications
- Surface mount miniature package
- Avalanche rated
- ECOPACK2 component

Applications

- Cordless appliance
- SSD
- Battery charger
- Telecom power
- DC / DC converter

Description

Single chip Schottky rectifiers designed for high frequency miniature switched mode power supplies such as adaptors and on board DC/DC converters.

Packaged in SMA, SMA Flat, SMA Flat Notch and SMB Flat, the [STPS2L30](#) is ideal for use in parallel with MOSFETs in synchronous rectification.

Product status	
STPS2L30	
Product summary	
Symbol	Value
$I_{F(AV)}$	2 A
V_{RRM}	30 V
$T_{j(max.)}$	150 °C
$V_{F(typ.)}$	0.325 V

1 Characteristics

Table 1. Absolute ratings (limiting values at 25 °C, unless otherwise specified)

Symbol	Parameter		Value	Unit		
V _{RRM}	Repetitive peak reverse voltage		30	V		
I _{F(AV)}	Average forward current, $\delta = 0.5$, square wave	SMA	T _L = 120 °C	2	A	
		SMA Flat, SMA Flat Notch				T _L = 130 °C
		SMB Flat				T _L = 135 °C
I _{FSM}	Surge non repetitive forward current		t _p = 10 ms sinusoidal	75	A	
P _{ARM}	Repetitive peak avalanche power		t _p = 10 μ s, T _j = 125 °C	108	W	
T _{stg}	Storage temperature range		-65 to +150		°C	
T _j	Maximum operating junction temperature ⁽¹⁾		+150		°C	

1. $(dP_{tot}/dT_j) < (1/R_{th(j-a)})$ condition to avoid thermal runaway for a diode on its own heatsink.

Table 2. Thermal resistance parameter

Symbol	Parameter		Max. value	Unit	
R _{th(j-l)}	Junction to lead	SMA	30	°C/W	
		SMA Flat, SMA Flat Notch			20
		SMB Flat			15

For more information, please refer to the following application note :

- AN5088 : Rectifiers thermal management, handling and mounting recommendations

Table 3. Static electrical characteristics

Symbol	Parameter	Test conditions		Min.	Typ.	Max.	Unit
I _R ⁽¹⁾	Reverse leakage current	T _j = 25 °C	V _R = V _{RRM}	-		200	μ A
		T _j = 100 °C		-	6	15	mA
V _F ⁽¹⁾	Forward voltage drop	T _j = 25 °C	I _F = 2 A	-		0.45	V
		T _j = 125 °C		-	0.325	0.375	
		T _j = 25 °C	I _F = 4 A	-		0.53	
		T _j = 125 °C		-	0.43	0.51	

1. Pulse test: t_p = 380 μ s, $\delta < 2\%$

To evaluate the conduction losses, use the following equation:

$$P = 0.24 \times I_{F(AV)} + 0.068 \times I_{F(RMS)}^2$$

For more information, please refer to the following application notes related to the power losses :

- AN604: Calculation of conduction losses in a power rectifier
- AN4021: Calculation of reverse losses on a power diode

1.1 Characteristics (curves)

Figure 1. Average forward power dissipation versus average forward current

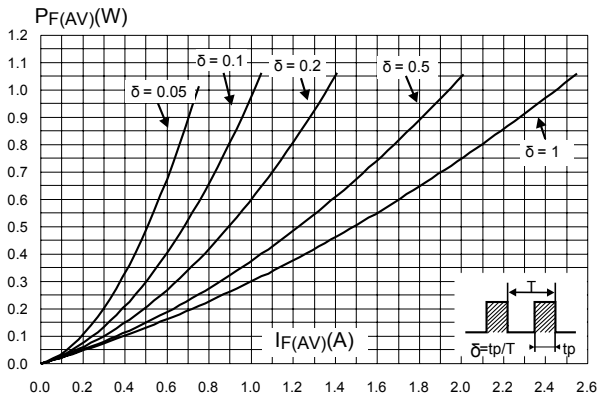

Figure 2. Average forward current versus ambient temperature ($\delta = 0.5$) SMA

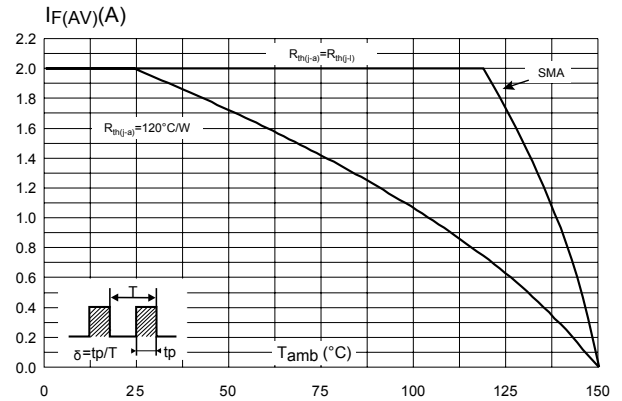

Figure 3. Average forward current versus ambient temperature ($\delta = 0.5$, SMB Flat)

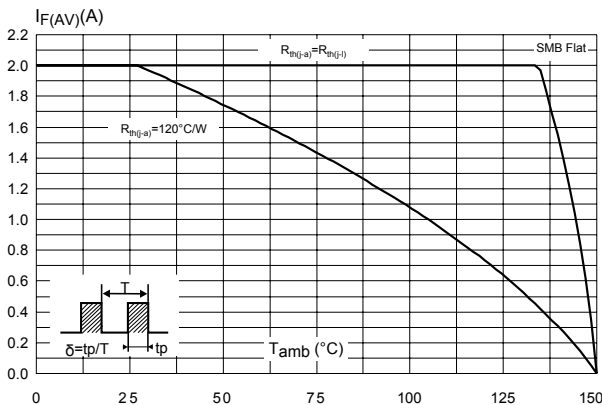

Figure 4. Average forward current versus ambient temperature ($\delta = 0.5$, SMA Flat, SMA Flat Notch)

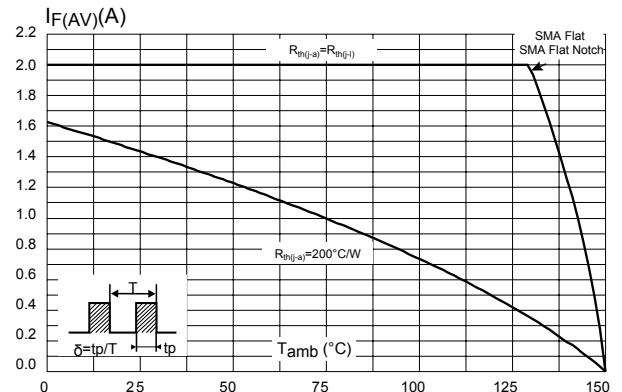

Figure 5. Normalized avalanche power derating versus pulse duration ($T_j = 125\text{ °C}$)

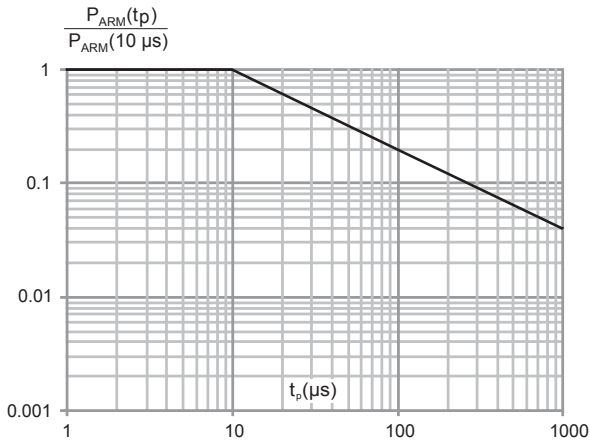

Figure 6. Relative variation of thermal impedance junction to ambient versus pulse duration (SMA)

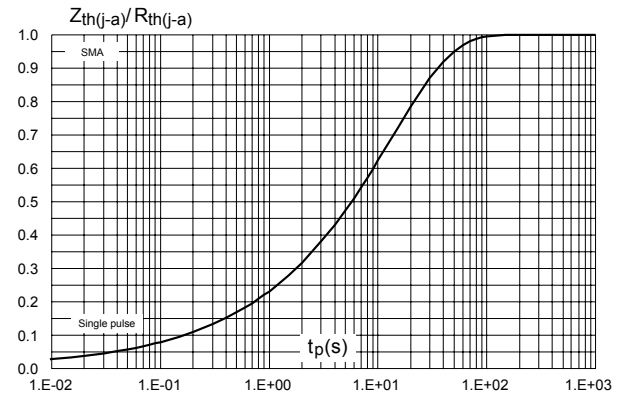

Figure 7. Relative variation of thermal impedance junction to lead versus pulse duration (SMB Flat)

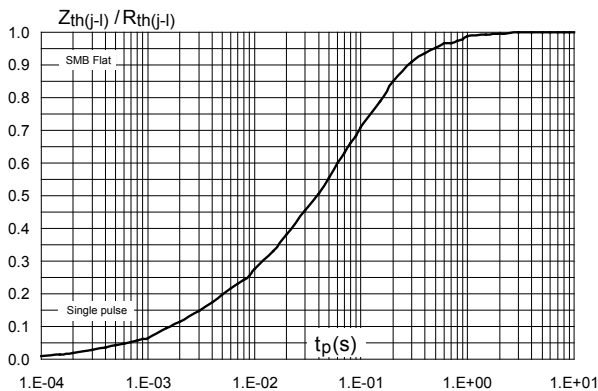

Figure 8. Relative variation of thermal impedance junction to ambient versus pulse duration (SMA Flat, SMA Flat Notch)

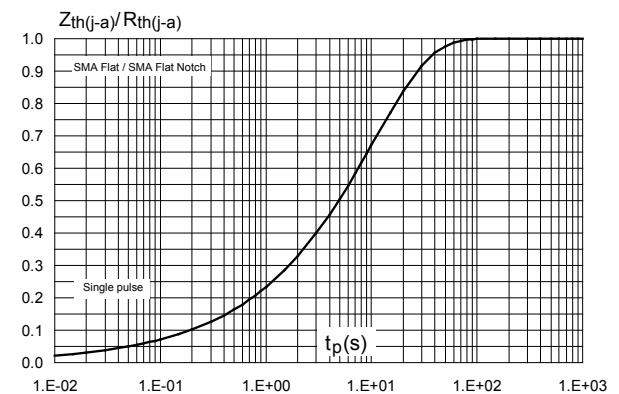

Figure 9. Reverse leakage current versus reverse voltage applied (typical values)

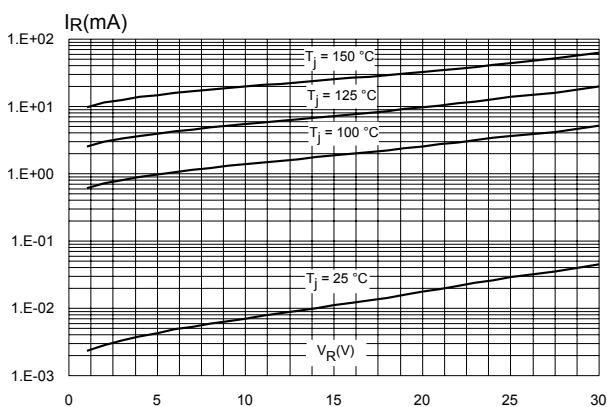

Figure 10. Junction capacitance versus reverse voltage applied (maximum values)

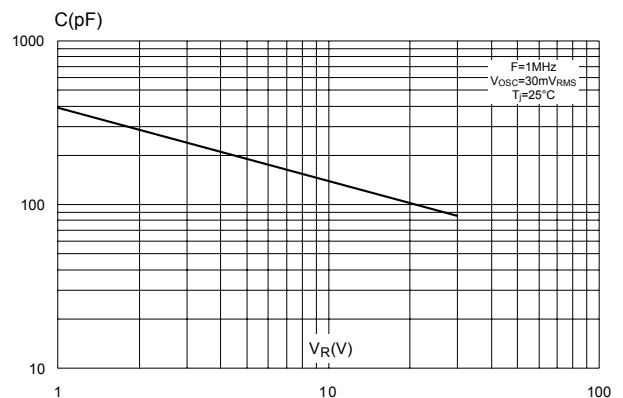

Figure 11. Forward voltage drop versus forward current (high level)

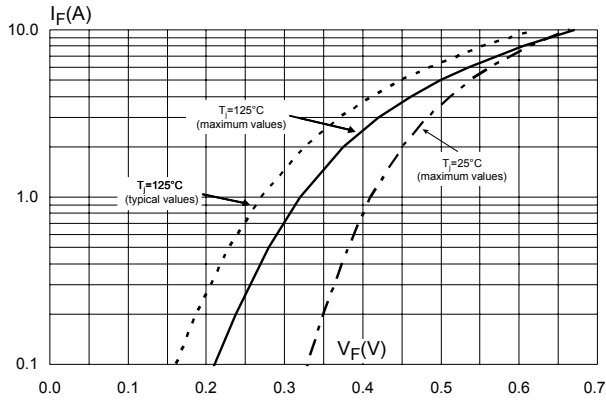

Figure 12. Forward voltage drop versus forward current (low level)

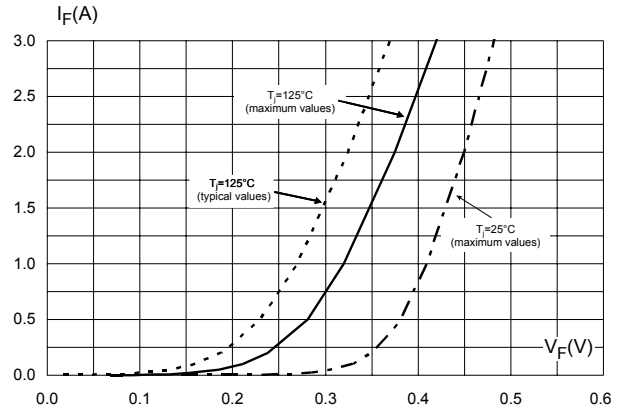

Figure 13. Thermal resistance junction to ambient versus copper surface under each lead (SMA)

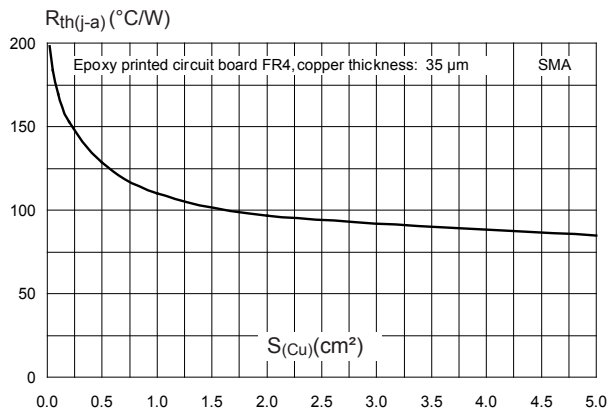

Figure 14. Thermal resistance junction to ambient versus copper surface under each lead (SMA Flat, SMA Flat Notch)

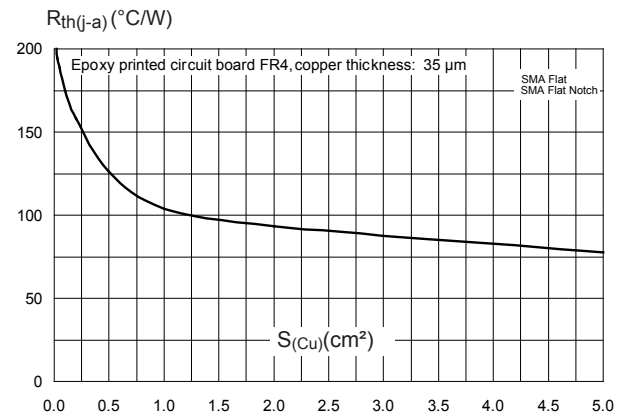
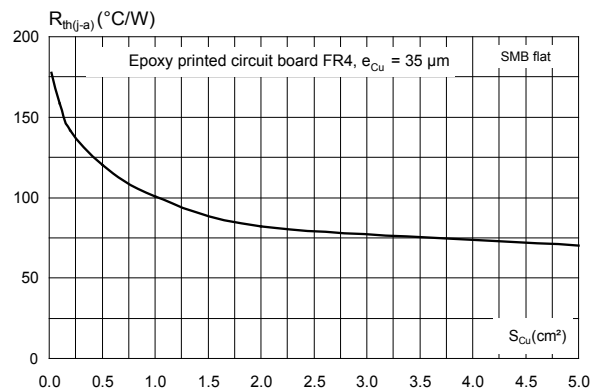

Figure 15. Thermal resistance junction to ambient versus copper surface under each lead (SMB Flat)



2 Package information

In order to meet environmental requirements, ST offers these devices in different grades of **ECOPACK** packages, depending on their level of environmental compliance. ECOPACK specifications, grade definitions and product status are available at: www.st.com. ECOPACK is an ST trademark.

2.1 SMA package information

- Epoxy meets UL94, V0
- Cooling method : by conduction (C)

Figure 16. SMA package outline

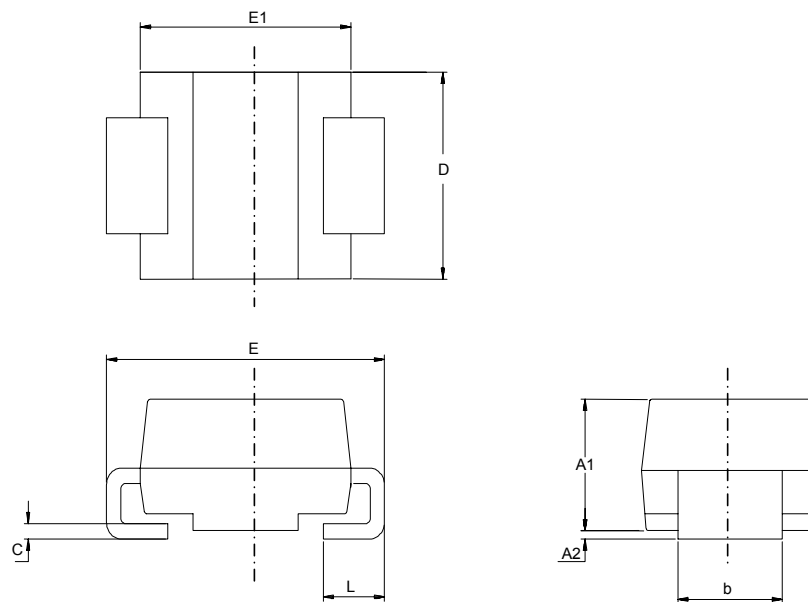
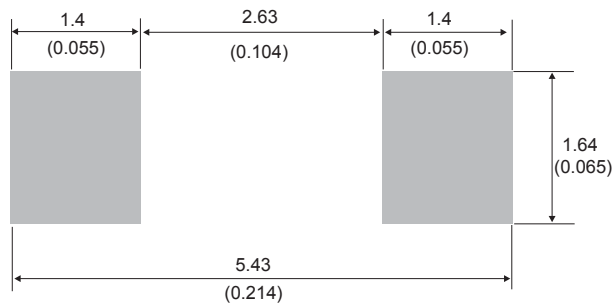

Table 4. SMA package mechanical data

Ref.	Dimensions			
	Millimeters		Inches (for reference only)	
	Min.	Max.	Min.	Max.
A1	1.90	2.45	0.074	0.097
A2	0.05	0.20	0.001	0.008
b	1.25	1.65	0.049	0.065
c	0.15	0.40	0.005	0.016
D	2.25	2.90	0.088	0.115
E	4.80	5.35	0.188	0.211
E1	3.95	4.60	0.155	0.182
L	0.75	1.50	0.029	0.060

Figure 17. SMA recommended footprint in mm (inches)



2.2 SMA Flat package information

- Epoxy meets UL94, V0
- Lead-free package

Figure 18. SMA Flat package outline

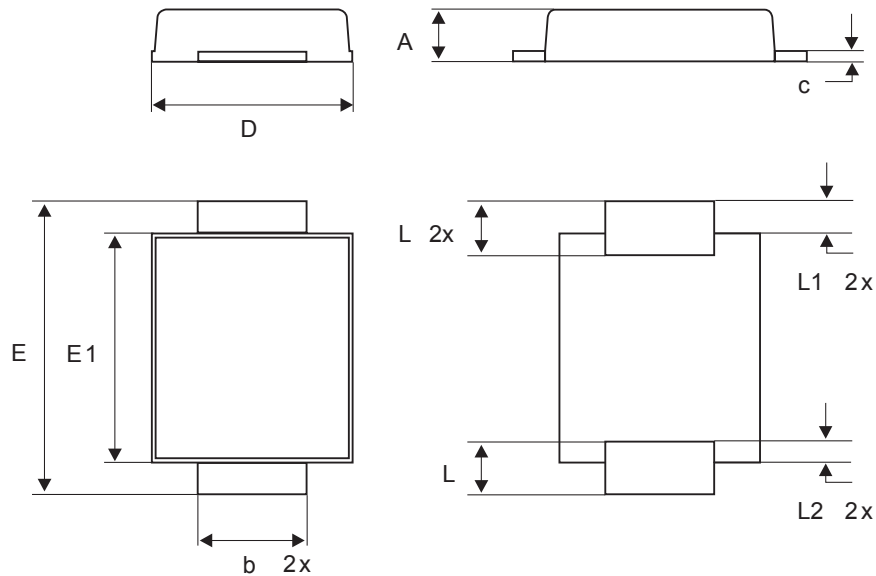
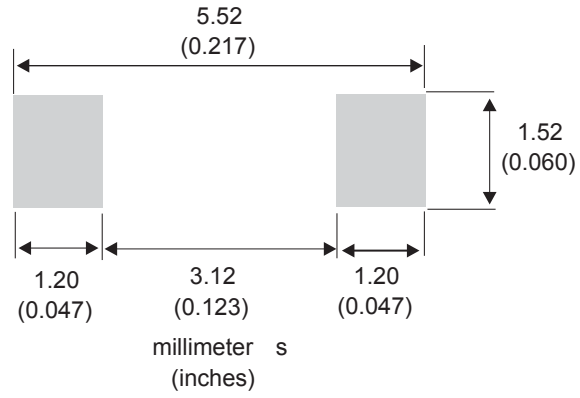

Table 5. SMA Flat package mechanical data

Ref.	Dimensions					
	Millimeters			Inches (for reference only)		
	Min.	Typ.	Max.	Min.	Typ.	Max.
A	0.90		1.10	0.035		0.044
b	1.25		1.65	0.049		0.065
c	0.15		0.40	0.005		0.016
D	2.25		2.95	0.088		0.117
E	4.80		5.60	0.188		0.221
E1	3.95		4.60	0.155		0.182
L	0.75		1.50	0.029		0.060
L1		0.50			0.020	
L2		0.50			0.020	

Figure 19. SMA Flat recommended footprint in mm (inches)



2.3 SMA Flat Notch package information

- Epoxy meets UL94, V0
- Cooling method: by conduction (C)
- Band indicates cathode

Figure 20. SMA Flat Notch package outline

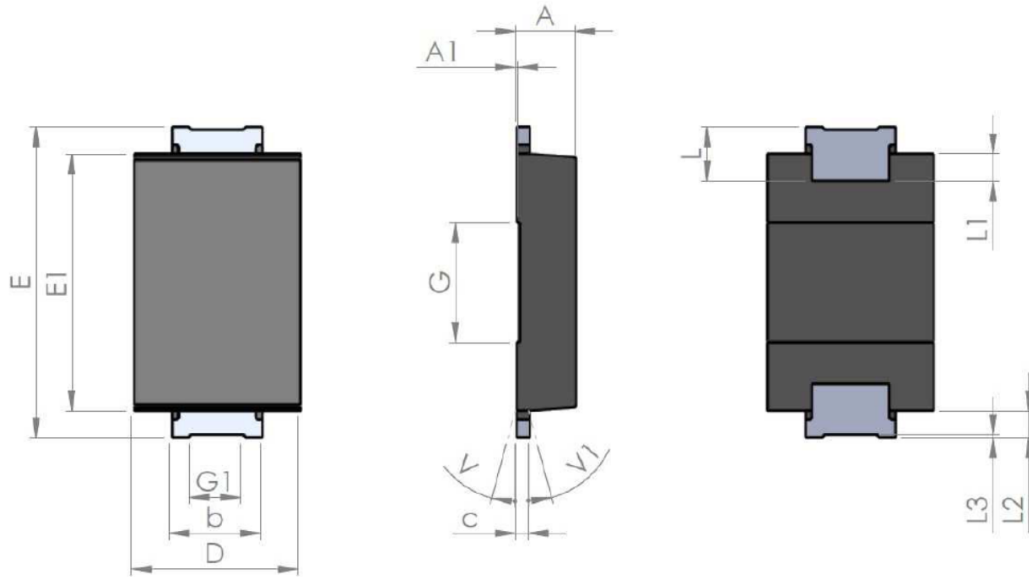
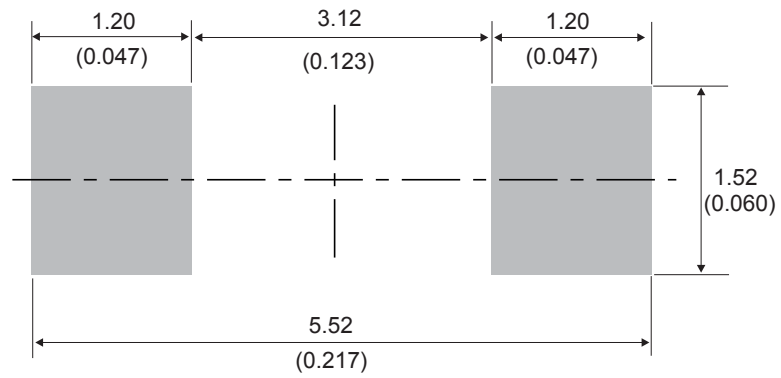

Table 6. SMA Flat Notch package mechanical data

Ref.	Dimensions					
	Millimeters			Inches (for reference only)		
	Min.	Typ.	Max.	Min.	Typ.	Max.
A1	0.90		1.10	0.035		0.044
A1		0.05			0.002	
b	1.25		1.65	0.049		0.065
C	0.15		0.40	0.005		0.016
D	2.25		2.90	0.088		0.115
E	5.00		5.35	0.196		0.211
E1	3.95		4.60	0.155		0.182
G		2.00			0.079	
G1		0.85			0.033	
L	0.75		1.20	0.029		
L1		0.45			0.018	
L2		0.45			0.018	
L3		0.05			0.002	
V			8°			8°
V1			8°			8°

Figure 21. SMA Flat Notch recommended footprint in mm (inches)



2.4 SMB Flat package information

- Epoxy meets UL94, V0
- Lead-free package

Figure 22. SMB Flat package outline

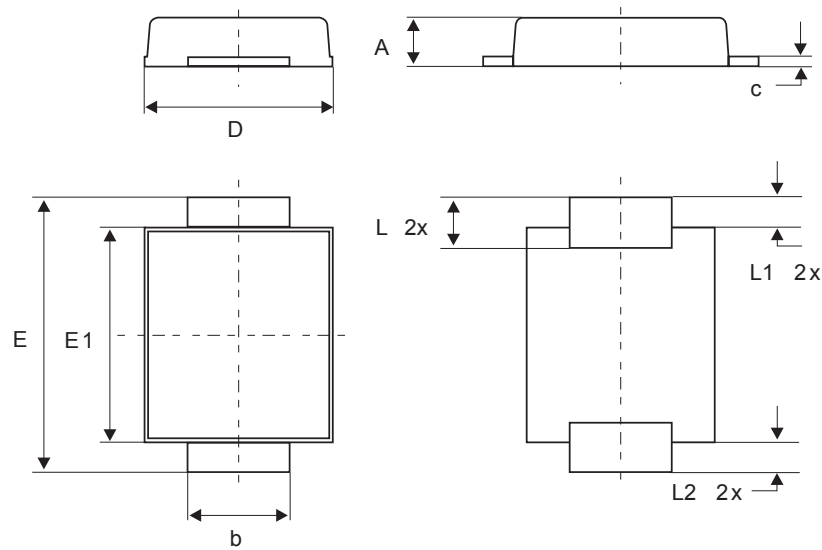
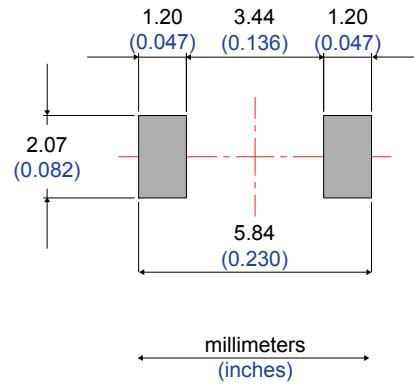

Table 7. SMB Flat mechanical data

Ref.	Dimensions					
	Millimeters			Inches (for reference only)		
	Min.	Typ.	Max.	Min.	Typ.	Max.
A	0.90		1.10	0.035		0.043
b	1.95		2.20	0.077		0.087
c	0.15		0.40	0.006		0.016
D	3.30		3.95	0.130		0.156
E	5.10		5.60	0.201		0.220
E1	4.05		4.60	0.159		0.181
L	0.75		1.50	0.030		0.059
L1		0.40			0.016	
L2		0.60			0.024	

Figure 23. Footprint recommendations, dimensions in mm (inches)



3 Ordering information

Table 8. Ordering information

Order code	Marking	Package	Weight	Base qty.	Delivery mode
STPS2L30A	G30	SMA	0.068 g	5000	Tape and reel
STPS2L30UF	FG30	SMB Flat	0.050 g	5000	Tape and reel
STPS2L30AFN	A23	SMA Flat Notch	0.039 g	10 000	Tape and reel
STPS2L30AF	F30	SMA Flat	0.035 g	10000	Tape and reel

Revision history

Table 9. Document revision history

Date	Version	Changes
Jul-2003	3A	Last update.
Aug-2004	4	SMA package dimensions update. Reference A1 max. changed from 2.70mm (0.106inc.) to 2.03mm (0.080).
31-Jan-2007	5	Reformatted to current standard. Added ECOPACK statement. Added SMB flat package.
23-Apr-2008	6	Reformatted to current standards. Added SMA flat package.
30-Nov-2018	7	Updated Table 1. Absolute ratings (limiting values at 25 °C, unless otherwise specified) and Figure 5. Normalized avalanche power derating versus pulse duration (T_j = 125 °C) .
26-Sep-2019	8	Added Section 2.3 SMA Flat Notch package information .

IMPORTANT NOTICE – PLEASE READ CAREFULLY

STMicroelectronics NV and its subsidiaries (“ST”) reserve the right to make changes, corrections, enhancements, modifications, and improvements to ST products and/or to this document at any time without notice. Purchasers should obtain the latest relevant information on ST products before placing orders. ST products are sold pursuant to ST’s terms and conditions of sale in place at the time of order acknowledgement.

Purchasers are solely responsible for the choice, selection, and use of ST products and ST assumes no liability for application assistance or the design of Purchasers’ products.

No license, express or implied, to any intellectual property right is granted by ST herein.

Resale of ST products with provisions different from the information set forth herein shall void any warranty granted by ST for such product.

ST and the ST logo are trademarks of ST. For additional information about ST trademarks, please refer to www.st.com/trademarks. All other product or service names are the property of their respective owners.

Information in this document supersedes and replaces information previously supplied in any prior versions of this document.

© 2019 STMicroelectronics – All rights reserved

Данный компонент на территории Российской Федерации

Вы можете приобрести в компании MosChip.

Для оперативного оформления запроса Вам необходимо перейти по данной ссылке:

<http://moschip.ru/get-element>

Вы можете разместить у нас заказ для любого Вашего проекта, будь то серийное производство или разработка единичного прибора.

В нашем ассортименте представлены ведущие мировые производители активных и пассивных электронных компонентов.

Нашей специализацией является поставка электронной компонентной базы двойного назначения, продукции таких производителей как XILINX, Intel (ex.ALTERA), Vicor, Microchip, Texas Instruments, Analog Devices, Mini-Circuits, Amphenol, Glenair.

Сотрудничество с глобальными дистрибьюторами электронных компонентов, предоставляет возможность заказывать и получать с международных складов практически любой перечень компонентов в оптимальные для Вас сроки.

На всех этапах разработки и производства наши партнеры могут получить квалифицированную поддержку опытных инженеров.

Система менеджмента качества компании отвечает требованиям в соответствии с ГОСТ Р ИСО 9001, ГОСТ РВ 0015-002 и ЭС РД 009

Офис по работе с юридическими лицами:

105318, г.Москва, ул.Щербаковская д.3, офис 1107, 1118, ДЦ «Щербаковский»

Телефон: +7 495 668-12-70 (многоканальный)

Факс: +7 495 668-12-70 (доб.304)

E-mail: info@moschip.ru

Skype отдела продаж:

moschip.ru

moschip.ru_4

moschip.ru_6

moschip.ru_9