

**MAXIM**

# Ultra-Small, Low-Cost, 210MHz, Single-Supply Op Amps with Rail-to-Rail Outputs and Disable

## General Description

The MAX4380–MAX4384 family of op amps are unity-gain-stable devices that combine high-speed performance, Rail-to-Rail® outputs, and high-impedance disable mode. These devices operate from a +4.5V to +11V single supply or from  $\pm 2.25V$  to  $\pm 5.5V$  dual supplies. The common-mode input voltage range extends beyond the negative power-supply rail (ground in single-supply applications).

The MAX4380–MAX4384 require only 5.5mA of quiescent supply current per op amp while achieving a 210MHz -3dB bandwidth, 55MHz 0.1dB gain flatness and a 485V/ $\mu$ s slew rate. These devices are an excellent solution in low-power/low-voltage systems that require wide bandwidth, such as video, communications, and instrumentation.

The MAX4380 single with disable is available in an ultra-small 6-pin SC70 package.

## Applications

Set-Top Boxes  
Surveillance Video Systems  
Battery-Powered Instruments  
Analog-to-Digital Converter Interface  
CCD Imaging Systems  
Video Routing and Switching Systems  
Digital Cameras  
Video-on-Demand  
Video Line Driver

## Typical Operating Circuit

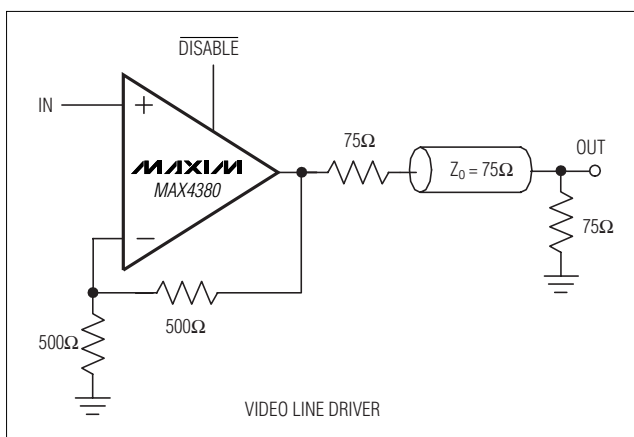

Rail-to-Rail is a registered trademark of Nippon Motorola, Ltd.

**MAXIM**

## Features

- ◆ Low Cost and High Speed:
  - 210MHz -3dB Bandwidth
  - 55MHz 0.1dB Gain Flatness
  - 485V/ $\mu$ s Slew Rate
- ◆ Disable Mode Places Outputs in High-Impedance State
- ◆ Single +4.5V to +11V Operation
- ◆ Rail-to-Rail Outputs
- ◆ Input Common-Mode Range Extends Beyond  $V_{EE}$
- ◆ Low Differential Gain/Phase: 0.02%/0.08°
- ◆ Low Distortion at 5MHz
  - 65dBc SFDR
  - 63dB Total Harmonic Distortion
- ◆ Ultra-Small 6-Pin SC70, 6-Pin SOT23, 10-Pin  $\mu$ MAX, 14-Pin TSSOP, and 20-Pin TSSOP Packages

## Ordering Information

PART	TEMP RANGE	PIN-PACKAGE	TOP MARK
MAX4380EXT-T	-40°C to +85°C	6 SC70-6	AAV
MAX4380EUT-T	-40°C to +85°C	6 SOT23-6	—
MAX4381EUB	-40°C to +85°C	10 $\mu$ MAX	—
MAX4382EUD	-40°C to +85°C	14 TSSOP	—
MAX4382ESD	-40°C to +85°C	14 SO	—
MAX4382EEE	-40°C to +85°C	16 QSOP	—
MAX4383EUD	-40°C to +85°C	14 TSSOP	—
MAX4383ESD	-40°C to +85°C	14 SO	—
MAX4383ESE	-40°C to +85°C	16 SO	—
MAX4383EEE	-40°C to +85°C	16 QSOP	—
MAX4384EUP	-40°C to +85°C	20 TSSOP	—

## Pin Configurations



Maxim Integrated Products 1

For pricing, delivery, and ordering information, please contact Maxim/Dallas Direct! at 1-888-629-4642, or visit Maxim's website at [www.maxim-ic.com](http://www.maxim-ic.com).

**MAX4380–MAX4384**

# Ultra-Small, Low-Cost, 210MHz, Single-Supply Op Amps with Rail-to-Rail Outputs and Disable

## ABSOLUTE MAXIMUM RATINGS

Supply Voltage ( $V_{CC}$ to $V_{EE}$ ).....	+12V	14-Pin SO (derate 8.3mW/°C above +70°C).....	667mW
$IN_{-}$ , $IN_{+}$ , $OUT_{-}$ , $DISABLE_{-}$ .....	( $V_{EE} - 0.3V$ ) to ( $V_{CC} + 0.3V$ )	16-Pin QSOP (derate 8.3mW/°C above +70°C).....	667mW
Output Short-Circuit to $V_{CC}$ or $V_{EE}$ .....	1s	16-Pin Narrow SO (derate 8.7mW/°C above +70°C).....	696mW
Continuous Power Dissipation ( $T_A = +70^{\circ}C$ )		20-Pin TSSOP (derate 10.9mW/°C above +70°C).....	879mW
6-Pin SC70 (derate 3.1mW/°C above +70°C).....	245mW	Operating Temperature Range.....	-40°C to +85°C
6-Pin SOT23 (derate 7.1mW/°C above +70°C).....	571mW	Junction Temperature.....	+150°C
10-Pin $\mu$ MAX (derate 5.6mW/°C above +70°C).....	444mW	Storage Temperature Range.....	-65°C to +150°C
14-Pin TSSOP (derate 9.1mW/°C above +70°C).....	727mW	Lead Temperature (soldering, 10s).....	+300°C

Stresses beyond those listed under "Absolute Maximum Ratings" may cause permanent damage to the device. These are stress ratings only, and functional operation of the device at these or at any other conditions beyond those indicated in the operational sections of the specifications is not implied. Exposure to absolute maximum rating conditions for extended periods may affect device reliability.

## DC ELECTRICAL CHARACTERISTICS—Single Supply

( $V_{CC} = +5V$ ,  $V_{EE} = 0$ ,  $V_{CM} = V_{CC}/2$ ,  $V_{OUT} = V_{CC}/2$ ,  $R_L = \infty$  to  $V_{CC}/2$ ,  $DISABLE_{-} = V_{CC}$  (MAX4380/MAX4381/MAX4382/MAX4384),  $T_A = T_{MIN}$  to  $T_{MAX}$ , unless otherwise noted. Typical values are at  $T_A = +25^{\circ}C$ .) (Note 1)

PARAMETER	SYMBOL	CONDITIONS	MIN	TYP	MAX	UNITS
Input Common-Mode Voltage Range	$V_{CM}$	Guaranteed by CMRR	$V_{EE} - 0.2$		$V_{CC} - 2.25$	V
Input Offset Voltage	$V_{OS}$	$T_A = +25^{\circ}C$		0.2	12	mV
		$T_A = -40^{\circ}C$ to $+85^{\circ}C$			20	
Input Offset Voltage Matching		MAX4381-MAX4384		1		mV
Input Offset Voltage Tempco	$TC_{VOS}$			8		$\mu V/^{\circ}C$
Input Bias Current	$I_B$			6.5	20	$\mu A$
Input Offset Current	$I_{OS}$			0.5	7	$\mu A$
Input Resistance	$R_{IN}$	Differential mode ( $-1V \leq V_{IN} \leq +1V$ )		70		k $\Omega$
		Common mode ( $-0.2V \leq V_{CM} \leq +2.75V$ )		3		M $\Omega$
Common-Mode Rejection Ratio	CMRR	$V_{EE} - 0.2V \leq V_{CM} \leq V_{CC} - 2.25V$	70	95		dB
Open-Loop Gain	$A_{VOL}$	$0.25V \leq V_{OUT} \leq 4.75V$ , $R_L = 2k\Omega$	50	61		dB
		$0.8V \leq V_{OUT} \leq 4.5V$ , $R_L = 150\Omega$	48	63		
		$1V \leq V_{OUT} \leq 4V$ , $R_L = 50\Omega$		58		
Output Voltage Swing	$V_{OUT}$	$R_L = 2k\Omega$	$V_{CC} - V_{OH}$	0.05	0.2	V
			$V_{OL} - V_{EE}$	0.05	0.15	
		$R_L = 150\Omega$	$V_{CC} - V_{OH}$	0.3	0.5	
			$V_{OL} - V_{EE}$	0.25	0.8	
		$R_L = 75\Omega$	$V_{CC} - V_{OH}$	0.5	0.8	
			$V_{OL} - V_{EE}$	0.5	1.75	
$R_L = 75\Omega$ to ground	$V_{CC} - V_{OH}$	1	1.7			
	$V_{OL} - V_{EE}$	0.025	0.125			
Output Current	$I_{OUT}$	Sinking from $R_L = 75\Omega$ to $V_{CC}$	40	55		mA
		Sourcing into $R_L = 75\Omega$ to $V_{EE}$	25	50		
Output Short-Circuit Current	$I_{SC}$	Sinking or sourcing		$\pm 100$		mA
Open-Loop Output Resistance	$R_{OUT}$			8		$\Omega$
Power-Supply Rejection Ratio	PSRR	$V_S = +4.5V$ to $+5.5V$	50	62		dB

# Ultra-Small, Low-Cost, 210MHz, Single-Supply Op Amps with Rail-to-Rail Outputs and Disable

MAX4380-MAX4384

## DC ELECTRICAL CHARACTERISTICS—Single Supply

( $V_{CC} = +5V$ ,  $V_{EE} = 0$ ,  $V_{CM} = V_{CC}/2$ ,  $V_{OUT} = V_{CC}/2$ ,  $R_L = \infty$  to  $V_{CC}/2$ ,  $\overline{DISABLE}_- = V_{CC}$  (MAX4380/MAX4381/MAX4382/MAX4384),  $T_A = T_{MIN}$  to  $T_{MAX}$ , unless otherwise noted. Typical values are at  $T_A = +25^\circ C$ .) (Note 1)

PARAMETER	SYMBOL	CONDITIONS	MIN	TYP	MAX	UNITS
Operating Supply Voltage Range	$V_S$	Guaranteed by PSRR (Note 2)	4.5		11	V
Disabled Output Resistance	$R_{OUT(OFF)}$	$\overline{DISABLE}_- = 0$ , $0 \leq V_{OUT} \leq 5V$	27	35		$k\Omega$
$\overline{DISABLE}_-$ Logic-Low Threshold	$V_{IL}$				$V_{CC} - 3$	V
$\overline{DISABLE}_-$ Logic-High Threshold	$V_{IH}$		$V_{CC} - 1.25$			V
$\overline{DISABLE}_-$ Logic Input Low Current	$I_{IL}$	$\overline{DISABLE}_- = 0$		25	60	$\mu A$
$\overline{DISABLE}_-$ Logic Input High Current	$I_{IH}$	$\overline{DISABLE}_- = V_{CC}$		10	40	$\mu A$
Quiescent Supply Current (Per Amplifier)	$I_S$	$\overline{DISABLE}_- = V_{CC}$		5.5	9	mA
		$\overline{DISABLE}_- = 0$		0.45	0.6	

## DC ELECTRICAL CHARACTERISTICS—Dual Supply

( $V_{CC} = +5V$ ,  $V_{EE} = -5V$ ,  $V_{CM} = 0$ ,  $V_{OUT} = 0$ ,  $R_L = \infty$  to 0,  $\overline{DISABLE}_- = V_{CC}$  (MAX4380/MAX4381/MAX4382/MAX4384),  $T_A = T_{MIN}$  to  $T_{MAX}$ , unless otherwise noted. Typical values are at  $T_A = +25^\circ C$ .) (Note 1)

PARAMETER	SYMBOL	CONDITIONS	MIN	TYP	MAX	UNITS
Input Common-Mode Voltage Range	$V_{CM}$	Guaranteed by CMRR	$V_{EE}$		$V_{CC} - 2.25$	V
Input Offset Voltage	$V_{OS}$	$T_A = +25^\circ C$		3	16	mV
		$T_A = T_{MIN}$ to $T_{MAX}$			24	
Input Offset Voltage Matching		MAX4381-MAX4384		1		mV
Input Offset Voltage Tempco	$TC_{VOS}$			8		$\mu V/^\circ C$
Input Bias Current	$I_B$			8.5	25	$\mu A$
Input Offset Current	$I_{OS}$			0.5	12	$\mu A$
Input Resistance	$R_{IN}$	Differential mode ( $-1V \leq V_{IN} \leq +1V$ )		70		$k\Omega$
		Common mode ( $-5V \leq V_{CM} \leq 2.75V$ )		3		$M\Omega$
Common-Mode Rejection Ratio	CMRR	$V_{EE} \leq V_{CM} \leq V_{CC} - 2.25V$	70	95		dB
Open-Loop Gain	$A_{VOL}$	$-4.5V \leq V_{OUT} \leq +4.5V$ , $R_L = 2k\Omega$	50	62		dB
		$-4.25V \leq V_{OUT} \leq +4.25V$ , $R_L = 150\Omega$	48	65		
		$-4V \leq V_{OUT} \leq +4V$ , $R_L = 50\Omega$		60		
Output Voltage Swing	$V_{OUT}$	$R_L = 2k\Omega$	$V_{CC} - V_{OH}$	0.175	0.375	V
			$V_{OL} - V_{EE}$	0.075	0.225	
		$R_L = 150\Omega$	$V_{CC} - V_{OH}$	0.575	0.85	
			$V_{OL} - V_{EE}$	0.4	0.775	
		$R_L = 75\Omega$	$V_{CC} - V_{OH}$	1.3	2.3	
			$V_{OL} - V_{EE}$	1.3	2.45	

# Ultra-Small, Low-Cost, 210MHz, Single-Supply Op Amps with Rail-to-Rail Outputs and Disable

## DC ELECTRICAL CHARACTERISTICS—Dual Supply (continued)

( $V_{CC} = +5V$ ,  $V_{EE} = -5V$ ,  $V_{CM} = 0$ ,  $V_{OUT} = 0$ ,  $R_L = \infty$  to  $0$ ,  $\overline{DISABLE}_- = V_{CC}$  (MAX4380/MAX4381/MAX4382/MAX4384),  $T_A = T_{MIN}$  to  $T_{MAX}$ , unless otherwise noted. Typical values are at  $T_A = +25^\circ C$ .) (Note 1)

PARAMETER	SYMBOL	CONDITIONS	MIN	TYP	MAX	UNITS
Output Current	$I_{OUT}$	Sinking from $R_L = 75\Omega$ to $V_{CC}$	50	75		mA
		Sourcing into $R_L = 75\Omega$ to $V_{EE}$	50	75		
Output Short-Circuit Current	$I_{SC}$	Sinking or sourcing		$\pm 100$		mA
Open-Loop Output Resistance	$R_{OUT}$			8		$\Omega$
Power-Supply Rejection Ratio	PSRR	$V_S = \pm 4.5V$ to $\pm 5.5V$	48	62		dB
Operating Supply Voltage Range	$V_S$	Guaranteed by PSRR (Note 2)	$\pm 2.25$		$\pm 5.5$	V
Disabled Output Resistance	$R_{OUT(OFF)}$	$\overline{DISABLE}_- = 0$ , $-5V \leq V_{OUT} \leq 5V$	27	35		k $\Omega$
$\overline{DISABLE}_-$ Logic-Low Threshold	$V_{IL}$				$V_{CC} - 3$	V
$\overline{DISABLE}_-$ Logic-High Threshold	$V_{IH}$		$V_{CC} - 1.25$			V
$\overline{DISABLE}_-$ Logic Input Low Current	$I_{IL}$	$\overline{DISABLE}_- = 0$		25		$\mu A$
$\overline{DISABLE}_-$ Logic Input High Current	$I_{IH}$	$\overline{DISABLE}_- = V_{CC}$		10		$\mu A$
Quiescent Supply Current (Per Amplifier)	$I_S$	$\overline{DISABLE}_- = V_{CC}$		7.5	10	mA
		$\overline{DISABLE}_- = 0$		0.45	0.8	

## AC ELECTRICAL CHARACTERISTICS—Single Supply

( $V_{CC} = +5V$ ,  $V_{EE} = 0$ ,  $V_{CM} = +1.5V$ ,  $R_L = 100\Omega$  to  $V_{CC}/2$ ,  $\overline{DISABLE}_- = V_{CC}$  (MAX4380/MAX4381/MAX4382/MAX4384),  $V_{OUT} = V_{CC}/2$ ,  $A_{VCL} = +1V/V$ ,  $T_A = +25^\circ C$ , unless otherwise noted.)

PARAMETER	SYMBOL	CONDITIONS	MIN	TYP	MAX	UNITS
Small-Signal -3dB Bandwidth	$BW_{SS}$	$V_{OUT} = 100mVp-p$		210		MHz
Large-Signal -3dB Bandwidth	$BW_{LS}$	$V_{OUT} = 2Vp-p$		175		MHz
Small-Signal 0.1dB Gain Flatness	$BW_{0.1dBSS}$	$V_{OUT} = 100mVp-p$		55		MHz
Large-Signal 0.1dB Gain Flatness	$BW_{0.1dBLS}$	$V_{OUT} = 2Vp-p$		40		MHz
Slew Rate	SR	$V_{OUT} = 2V$ step		485		V/ $\mu s$
Settling Time to 0.1%	$t_S$	$V_{OUT} = 2V$ step		16		ns
Rise/Fall Time	$t_R, t_F$	$V_{OUT} = 100mVp-p$		4		ns
Spurious-Free Dynamic Range	SFDR	$f_C = 5MHz$ , $V_{OUT} = 2Vp-p$		-65		dBc
Harmonic Distortion	HD	$f_C = 5MHz$ , $V_{OUT} = 2Vp-p$	2nd harmonic	-65		dBc
			3rd harmonic	-68		
			Total harmonic	-63		
Two-Tone, Third-Order Intermodulation Distortion	IP3	$f_1 = 4.7MHz$ , $f_2 = 4.8MHz$ , $V_{OUT} = 1Vp-p$		-66		dBc

# Ultra-Small, Low-Cost, 210MHz, Single-Supply Op Amps with Rail-to-Rail Outputs and Disable

MAX4380-MAX4384

## AC ELECTRICAL CHARACTERISTICS—Single Supply (continued)

( $V_{CC} = +5V$ ,  $V_{EE} = 0$ ,  $V_{CM} = +1.5V$ ,  $R_L = 100\Omega$  to  $V_{CC}/2$ ,  $\overline{DISABLE}_- = V_{CC}$  (MAX4380/MAX4381/MAX4382/MAX4384),  $V_{OUT} = V_{CC}/2$ ,  $A_{VCL} = +1V/V$ ,  $T_A = +25^\circ C$ , unless otherwise noted.)

PARAMETER	SYMBOL	CONDITIONS	MIN	TYP	MAX	UNITS
Channel-to-Channel Isolation	CH <sub>ISO</sub>	Specified at DC		-102		dB
Input 1dB Compression Point		$f_C = 10MHz$ , $A_{VCL} = +2V/V$		14		dBm
Differential Phase Error	DP	NTSC, $R_L = 150\Omega$		0.08		degrees
Differential Gain Error	DG	NTSC, $R_L = 150\Omega$		0.02		%
Input Noise-Voltage Density	$e_n$	$f = 10kHz$		10		nV/ $\sqrt{Hz}$
Input Noise-Current Density	$i_n$	$f = 10kHz$		2		pA/ $\sqrt{Hz}$
Input Capacitance	$C_{IN}$			1		pF
Output Impedance	$Z_{OUT}$	$f = 10MHz$		1.5		$\Omega$
Enable Time	$t_{ON}$	$V_{IN} = 1V$ (MAX4380/MAX4381/MAX4382/MAX4384)		100		ns
Disable Time	$t_{OFF}$	$V_{IN} = 1V$ (MAX4380/MAX4381/MAX4382/MAX4384)		1		$\mu s$

**Note 1:** All devices are 100% production tested at  $T_A = +25^\circ C$ . Specifications over temperature limits are guaranteed by design.

**Note 2:** PSRR for single +5V supply tested with  $V_{EE} = 0$ ,  $V_{CC} = +4.5V$  to  $+5.5V$ ; PSRR for dual  $\pm 5V$  supply tested with  $V_{EE} = -4.5V$  to  $-5.5V$ ,  $V_{CC} = +4.5V$  to  $+5.5V$ .

## Typical Operating Characteristics

( $V_{CC} = +5V$ ,  $V_{EE} = 0$ ,  $V_{CM} = +1.5V$ ,  $A_{VCL} = +1V/V$ ,  $R_L = 100\Omega$  to  $V_{CC}/2$ ,  $T_A = +25^\circ C$ , unless otherwise noted.)

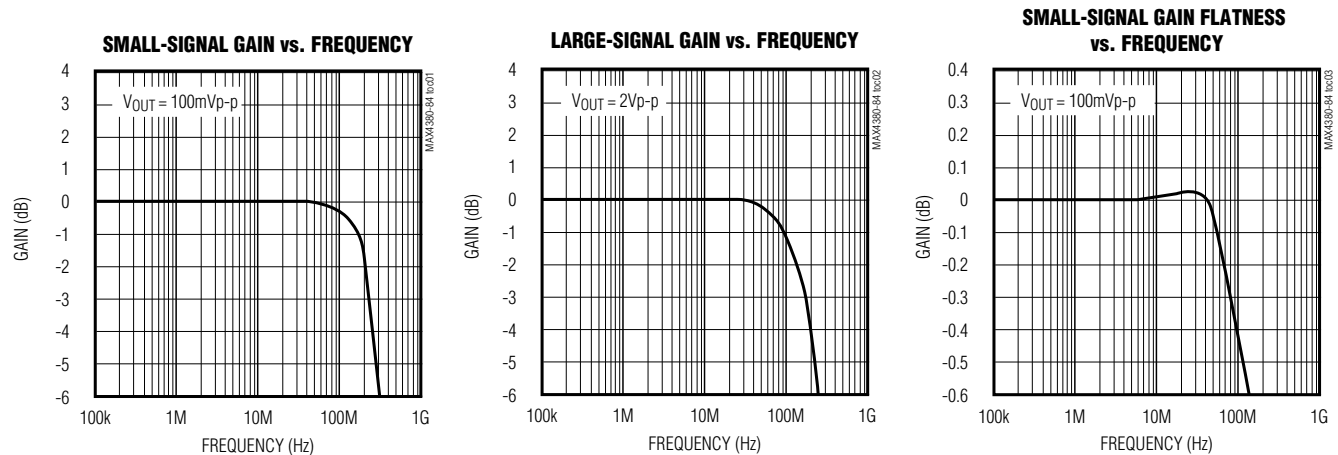

# Ultra-Small, Low-Cost, 210MHz, Single-Supply Op Amps with Rail-to-Rail Outputs and Disable

## Typical Operating Characteristics (continued)

( $V_{CC} = +5V$ ,  $V_{EE} = 0$ ,  $V_{CM} = +1.5V$ ,  $A_{VCL} = +1$ ,  $R_L = 100\Omega$  to  $V_{CC}/2$ ,  $T_A = +25^\circ C$ , unless otherwise noted.)

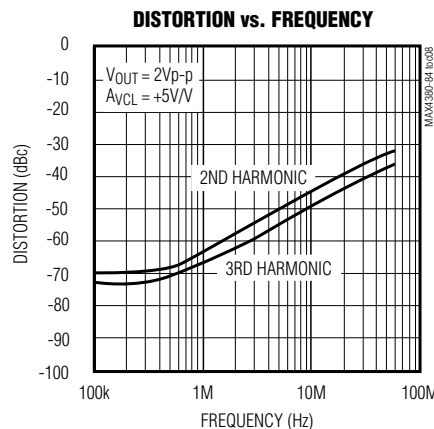
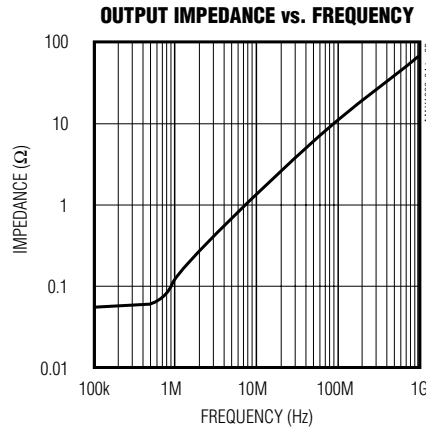

# Ultra-Small, Low-Cost, 200MHz, Single-Supply Op Amps with Rail-to-Rail Outputs and Disable

## Typical Operating Characteristics (continued)

( $V_{CC} = +5V$ ,  $V_{EE} = 0$ ,  $V_{CM} = +1.5V$ ,  $A_{VCL} = +1$ ,  $R_L = 100\Omega$  to  $V_{CC}/2$ ,  $T_A = +25^\circ C$ , unless otherwise noted.)

MAX4380-MAX4384

**POWER-SUPPLY REJECTION vs. FREQUENCY**



**OUTPUT VOLTAGE SWING vs. RESISTIVE LOAD**



**OUTPUT VOLTAGE SWING vs. RESISTIVE LOAD**



**SMALL-SIGNAL PULSE RESPONSE**



**SMALL-SIGNAL PULSE RESPONSE**



**SMALL-SIGNAL PULSE RESPONSE**



**LARGE-SIGNAL PULSE RESPONSE**



**LARGE-SIGNAL PULSE RESPONSE**



**LARGE-SIGNAL PULSE RESPONSE**



# Ultra-Small, Low-Cost, 210MHz, Single-Supply Op Amps with Rail-to-Rail Outputs and Disable

## Typical Operating Characteristics (continued)

( $V_{CC} = +5V$ ,  $V_{EE} = 0$ ,  $V_{CM} = +1.5V$ ,  $A_{VCL} = +1$ ,  $R_L = 100\Omega$  to  $V_{CC}/2$ ,  $T_A = +25^\circ C$ , unless otherwise noted.)

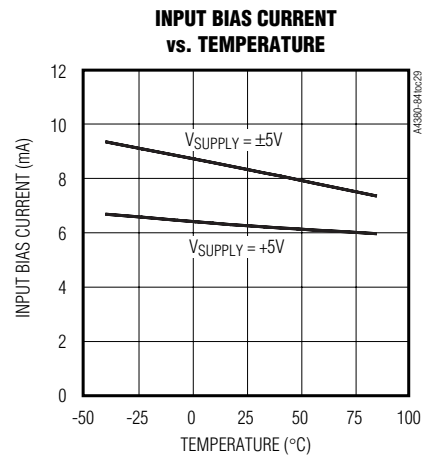
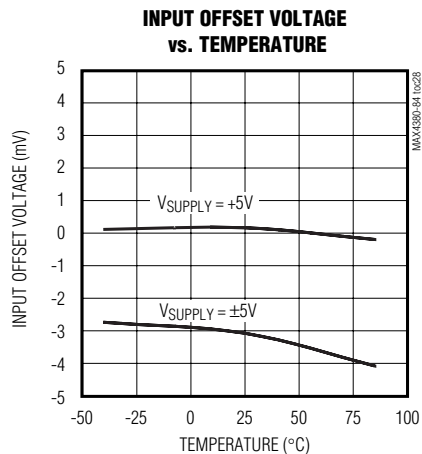
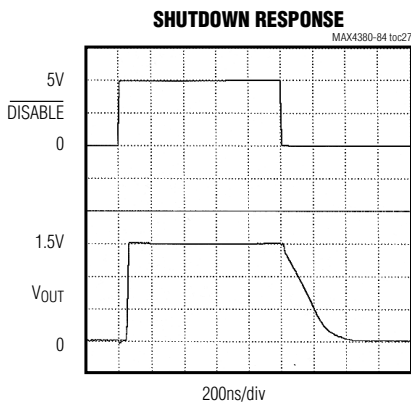
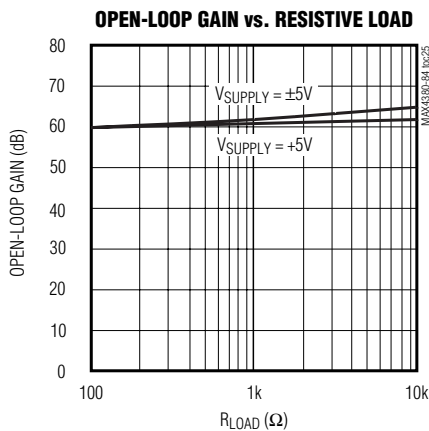
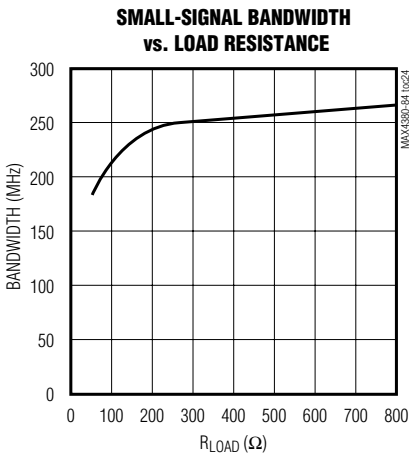
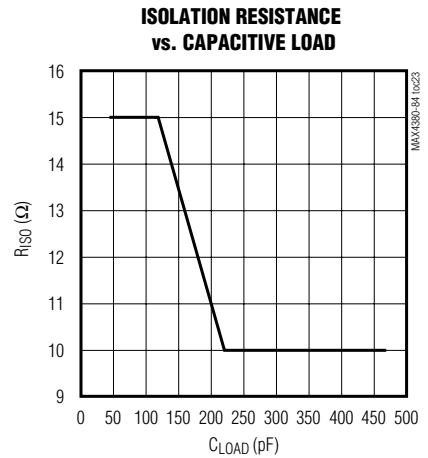
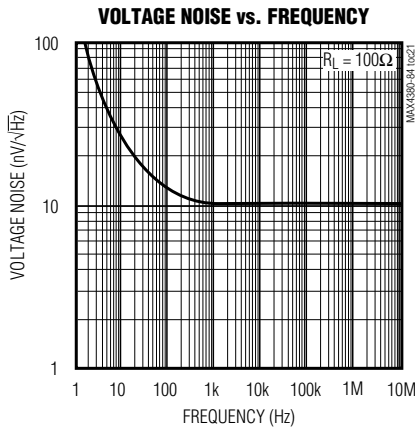



# Ultra-Small, Low-Cost, 210MHz, Single-Supply Op Amps with Rail-to-Rail Outputs and Disable

MAX4380-MAX4384

## Typical Operating Characteristics (continued)

( $V_{CC} = +5V$ ,  $V_{EE} = 0$ ,  $V_{CM} = +1.5V$ ,  $A_{VCL} = +1$ ,  $R_L = 100\Omega$  to  $V_{CC}/2$ ,  $T_A = +25^\circ C$ , unless otherwise noted.)

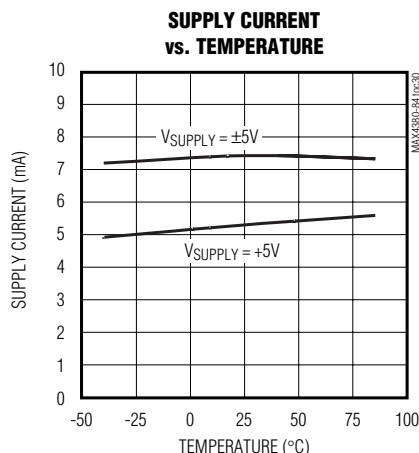

## Pin Description

PIN							NAME	FUNCTION
MAX4380	MAX4381	MAX4382		MAX4383		MAX4384		
SC70/SOT23	$\mu$ MAX	QSOP	SO/TSSOP	SO/TSSOP	SO/QSOP	TSSOP		
6	10	4	4	4	4	5	$V_{CC}$	Positive Power Supply. Connect a 0.1 $\mu$ F capacitor to GND.
2	4	13	11	11	13	16	$V_{EE}$	Negative Power Supply. Connect a 0.1 $\mu$ F Capacitor to GND.
3	—	—	—	—	—	—	IN+	Noninverting Input
4	—	—	—	—	—	—	IN-	Inverting Input
1	—	—	—	—	—	—	OUT	Amplifier Output
5	—	—	—	—	—	—	$\overline{DISABLE}$	Disable. Connect to $V_{CC}$ to Enable.
—	3	5	5	3	3	4	INA+	Amplifier A Noninverting Input
—	2	6	6	2	2	3	INA-	Amplifier A Inverting Input
—	1	7	7	1	1	2	OUTA	Amplifier A Output
—	5	1	1	—	—	1	$\overline{DISABLEA}$	Shutdown Amplifier A. Connect to $V_{CC}$ to Enable.
—	7	12	10	5	5	6	INB+	Amplifier B Noninverting Input

# Ultra-Small, Low-Cost, 210MHz, Single-Supply Op Amps with Rail-to-Rail Outputs and Disable

## Pin Description (continued)

PIN							NAME	FUNCTION
MAX4380	MAX4381	MAX4382		MAX4383		MAX4384		
SC70/SOT23	μMAX	QSOP	SO/TSSOP	SO/TSSOP	SO/QSOP	TSSOP		
—	8	11	9	6	6	7	INB-	Amplifier B Inverting Input
—	9	10	8	7	7	8	OUTB	Amplifier B Output
—	6	3	3	—	—	9	$\overline{\text{DISABLEB}}$	Shutdown Amplifier B. Connect to V <sub>CC</sub> to Enable.
—	—	14	12	10	12	15	INC+	Amplifier C Noninverting Input
—	—	15	13	9	11	14	INC-	Amplifier C Inverting Input
—	—	16	14	8	10	13	OUTC	Amplifier C Output
—	—	2	2	—	—	12	$\overline{\text{DISABLEC}}$	Shutdown Amplifier C. Connect to V <sub>CC</sub> to Enable.
—	—	—	—	12	14	17	IND+	Amplifier D Noninverting Input
—	—	—	—	13	15	18	IND-	Amplifier D Inverting Input
—	—	—	—	14	16	19	OUTD	Amplifier D Output
—	—	—	—	—	—	20	$\overline{\text{DISABLED}}$	Shutdown Amplifier D. Connect to V <sub>CC</sub> to Enable.
—	—	8, 9	—	—	8, 9	10, 11	N.C.	No Connection. Not internally connected.

### Detailed Description

The MAX4380–MAX4384 are single-supply, rail-to-rail, voltage-feedback amplifiers that employ current-feedback techniques to achieve 485V/μs slew rates and 210MHz bandwidths. Excellent harmonic distortion and differential gain/phase performance make these amplifiers an ideal choice for a wide variety of video and RF signal-processing applications.

### Applications Information

The output voltage swings to within 50mV of each supply rail. Local feedback around the output stage ensures low open-loop output impedance to reduce gain sensitivity to load variations. The input stage permits common-mode voltages beyond the negative supply and to within 2.25V of the positive supply rail.

### Choosing Resistor Values

#### Unity-Gain Configuration

The MAX4380–MAX4384 are internally compensated for unity gain. When configured for unity gain, a 24Ω resistor (R<sub>F</sub>) in series with the feedback path optimizes AC performance. This resistor improves AC response by reducing the Q of the parallel LC circuit formed by the parasitic feedback capacitance and inductance.

#### Video Line Driver

The MAX4380–MAX4384 are low-power, voltage-feedback amplifiers featuring bandwidths up to 210MHz, 0.1dB gain flatness to 55MHz. They are designed to minimize differential-gain error and differential-phase error to 0.02% and 0.08 degrees respectively. They

# Ultra-Small, Low-Cost, 210MHz, Single-Supply Op Amps with Rail-to-Rail Outputs and Disable

MAX4380-MAX4384



Figure 1a. Noninverting Gain Configuration



Figure 1b. Inverting Gain Configuration

have a 16ns settling time to 0.1%, 485V/ $\mu$ s slew rates, and output-current-drive capability of up to 75mA making them ideal for driving video loads.

## Inverting and Noninverting Configurations

Select the gain-setting feedback ( $R_F$ ) and input ( $R_G$ ) resistor values to fit your application. Large resistor values increase voltage noise and interact with the amplifier's input and PC board capacitance. This can generate undesirable poles and zeros and decrease bandwidth or cause oscillations. For example, a noninverting gain-of-two configuration ( $R_F = R_G$ ) using 1k $\Omega$  resistors, combined with 1pF of amplifier input capacitance and 1pF of PC board capacitance, causes a pole at 159MHz. Since this pole is within the amplifier bandwidth, it jeopardizes stability. Reducing the 1k $\Omega$  resistors to 100 $\Omega$  extends the pole frequency to 1.59GHz, but could limit output swing by adding 200 $\Omega$  in parallel with the amplifier's load resistor (Figures 1a and 1b).

## Layout and Power-Supply Bypassing

These amplifiers operate from a single +4.5V to +11V power supply or from dual  $\pm 2.25$ V to  $\pm 5.5$ V supplies. For

single-supply operation, bypass  $V_{CC}$  to ground with a 0.1 $\mu$ F capacitor as close to the pin as possible. If operating with dual supplies, bypass each supply with a 0.1 $\mu$ F capacitor.

Maxim recommends using microstrip and stripline techniques to obtain full bandwidth. To ensure that the PC board does not degrade the amplifier's performance, design it for a frequency greater than 1GHz. Pay careful attention to inputs and outputs to avoid large parasitic capacitance. Whether or not you use a constant-impedance board, observe the following design guidelines:

- Don't use wire-wrap boards; they are too inductive.
- Don't use IC sockets; they increase parasitic capacitance and inductance.
- Use surface-mount instead of through-hole components for better high-frequency performance.
- Use a PC board with at least two layers; it should be as free from voids as possible.
- Keep signal lines as short and as straight as possible. Do not make 90° turns; round all corners.

## Rail-to-Rail Outputs, Ground-Sensing Inputs

For +5V single-supply operation, the input common-mode range extends from ( $V_{EE} - 200$ mV) to ( $V_{CC} - 2.25$ V) with excellent common-mode rejection. Beyond this range, the amplifier output is a nonlinear function of the input, but does not undergo phase reversal or latchup.

For  $\pm 5$ V dual-supply operation, the common-mode range is from  $V_{EE}$  to ( $V_{CC} - 2.25$ V)

For +5V single-supply operation the output swings to within 50mV of either power-supply rail with a 2k $\Omega$  load. The input ground sensing and the rail-to-rail output substantially increase the dynamic range. With a symmetric input in a single +5V application, the input can swing 2.95Vp-p and the output can swing 4.9Vp-p with minimal distortion.

## Low-Power Disable Mode

The disable feature ( $\overline{\text{DISABLE}}_1$ ) allows the amplifier to be placed in a low-power, high-output-impedance state. When the disable pin ( $\overline{\text{DISABLE}}_1$ ) is active, the amplifier's output impedance is 35k $\Omega$ . This high resistance and the low 2pF output capacitance make the MAX4380-MAX4382 and the MAX4384 ideal in RF/video multiplexer or switch applications. For larger arrays, pay careful attention to capacitive loading. Refer to the *Output Capacitive Loading and Stability* section.

# Ultra-Small, Low-Cost, 210MHz, Single-Supply Op Amps with Rail-to-Rail Outputs and Disable



Figure 2. Driving a Capacitive Load Through an Isolation Resistor



Figure 3. Isolation Resistance vs. Capacitive Load

### Output Capacitive Loading and Stability

The MAX4380-MAX4384 are optimized for AC performance. They are not designed to drive highly reactive loads, which decrease phase margin and may produce excessive ringing and oscillation. Figure 2 shows a circuit that eliminates this problem. Figure 3 is a graph of the Optimal Isolation Resistor (R<sub>S</sub>) vs. Capacitive Load. Figure 4 shows how a capacitive load causes excessive peaking of the amplifier's frequency response if the capacitor is not isolated from the amplifier by a resistor. A small isolation resistor (usually 10Ω to 15Ω) placed before the reactive load prevents ringing and oscillation. At higher capacitive loads, AC performance is controlled by the interaction of the load capacitance and the isolation resistor. Figure 5 shows the effect of a 15Ω isolation resistor on closed-loop response.



Figure 4. Small-Signal Gain vs. Frequency with Load Capacitance and No Isolation Resistor



Figure 5. Small-Signal Gain vs. Frequency with Load Capacitance and 27Ω Isolation Resistor

### Chip Information

- MAX4380 TRANSISTOR COUNT: 66
- MAX4381 TRANSISTOR COUNT: 132
- MAX4382 TRANSISTOR COUNT: 196
- MAX4383 TRANSISTOR COUNT: 264
- MAX4384 TRANSISTOR COUNT: 264

# Ultra-Small, Low-Cost, 210MHz, Single-Supply Op Amps with Rail-to-Rail Outputs and Disable

## Pin Configurations (continued)

**MAX4380-MAX4384**

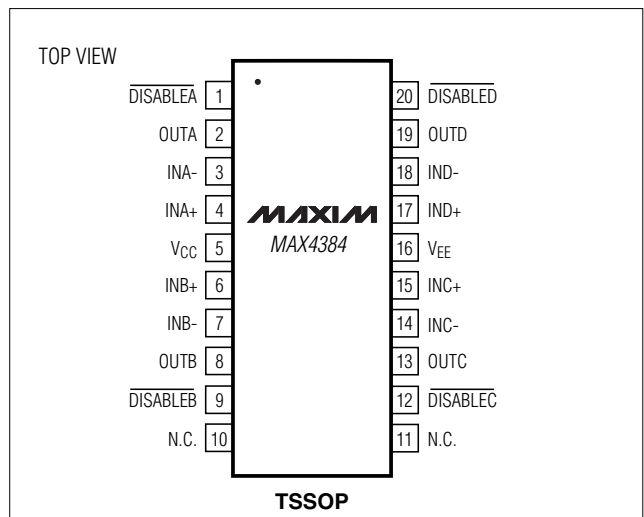
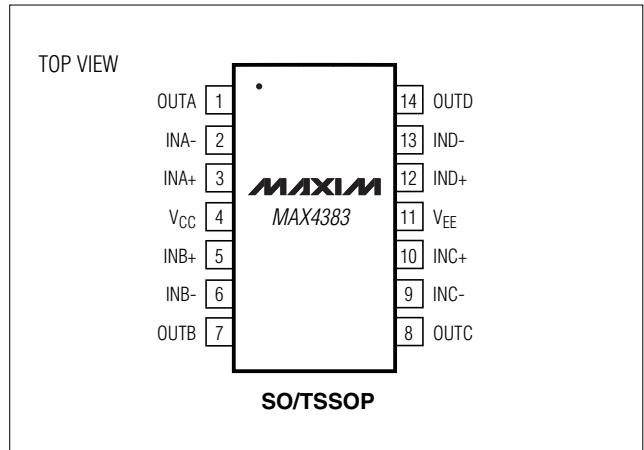
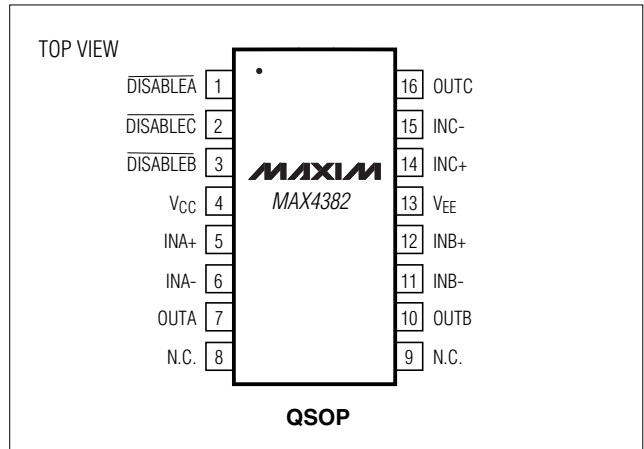

# Ultra-Small, Low-Cost, 210MHz, Single-Supply Op Amps with Rail-to-Rail Outputs and Disable

## Package Information

(The package drawing(s) in this data sheet may not reflect the most current specifications. For the latest package outline information go to [www.maxim-ic.com/packages](http://www.maxim-ic.com/packages).)



# Ultra-Small, Low-Cost, 210MHz, Single-Supply Op Amps with Rail-to-Rail Outputs and Disable

## Package Information (continued)

(The package drawing(s) in this data sheet may not reflect the most current specifications. For the latest package outline information go to [www.maxim-ic.com/packages](http://www.maxim-ic.com/packages).)

MAX4380-MAX4384



# Ultra-Small, Low-Cost, 210MHz, Single-Supply Op Amps with Rail-to-Rail Outputs and Disable

## Package Information (continued)

(The package drawing(s) in this data sheet may not reflect the most current specifications. For the latest package outline information go to [www.maxim-ic.com/packages](http://www.maxim-ic.com/packages).)



TSSOP4.40mm EFS



QSOP150°

Maxim cannot assume responsibility for use of any circuitry other than circuitry entirely embodied in a Maxim product. No circuit patent licenses are implied. Maxim reserves the right to change the circuitry and specifications without notice at any time.

16 **Maxim Integrated Products, 120 San Gabriel Drive, Sunnyvale, CA 94086 408-1737-7600**



## Данный компонент на территории Российской Федерации

### Вы можете приобрести в компании MosChip.

Для оперативного оформления запроса Вам необходимо перейти по данной ссылке:

<http://moschip.ru/get-element>

Вы можете разместить у нас заказ для любого Вашего проекта, будь то серийное производство или разработка единичного прибора.

В нашем ассортименте представлены ведущие мировые производители активных и пассивных электронных компонентов.

Нашей специализацией является поставка электронной компонентной базы двойного назначения, продукции таких производителей как XILINX, Intel (ex.ALTERA), Vicor, Microchip, Texas Instruments, Analog Devices, Mini-Circuits, Amphenol, Glenair.

Сотрудничество с глобальными дистрибьюторами электронных компонентов, предоставляет возможность заказывать и получать с международных складов практически любой перечень компонентов в оптимальные для Вас сроки.

На всех этапах разработки и производства наши партнеры могут получить квалифицированную поддержку опытных инженеров.

Система менеджмента качества компании отвечает требованиям в соответствии с ГОСТ Р ИСО 9001, ГОСТ РВ 0015-002 и ЭС РД 009

### Офис по работе с юридическими лицами:

105318, г.Москва, ул.Щербаковская д.3, офис 1107, 1118, ДЦ «Щербаковский»

Телефон: +7 495 668-12-70 (многоканальный)

Факс: +7 495 668-12-70 (доб.304)

E-mail: [info@moschip.ru](mailto:info@moschip.ru)

Skype отдела продаж:

moschip.ru

moschip.ru\_4

moschip.ru\_6

moschip.ru\_9